

E5080A

Table of Contents

Administrative Tasks	1
VNA User Accounts and Passwords	1
Existing User Accounts	1
Add or Change User Accounts, Passwords, and Require Logon.....	1
Recovering from VNA Solid State Drive Problems	3
Microsoft Windows Considerations	4
Microsoft Windows on the VNA	4
Using USB	4
LAN Connections	4
Mouse Configuration.....	4
Windows Themes	4
Printing.....	5
Quick Start.....	6
Powering the VNA ON and OFF	6
Log off, Shut down or Restart the VNA.....	6
ON Mode.....	6
Shutdown Mode	6
Unplugging the VNA	7
Traces, Channels and Windows on the VNA	8
Traces	8
Channels	12
Windows	13
Quick Start Dialog.....	15
Step 1: Quick Start Dialog	15
Step 2: Stimulus Settings Dialogs.....	17
Steps 3: Cal Wizard Dialog (Optional)	21
Frequency Blanking.....	22
VNA Connectivity Guide	24
The VNA as a PC.....	24
GPIB Programming.....	24
Controlling External Devices.....	24
Using VNC to Control the VNA User Interface	25
On the VNA, run VNC Server	25
On the PC, run VNC Viewer	25
LXI and VXI Compliance	26
LXI.....	26
VXI	26

LAN Status	26
Using Help	28
VNA Documentation	28
Launching Help	28
Searching Help	28
Documentation Warranty	29
Help - About Network Analyzer	30
Search VNA Help	31
1. Set Up a Measurement	32
Preset the VNA	32
Preset Default Conditions	32
User Preset Conditions	32
Measurement Classes	34
What are Measurement Classes	34
Measurement Parameters	36
S-Parameters	36
Receiver Measurements	37
Ratioed Measurements	37
Unratioed (Absolute Power) Measurements	37
Frequency Range	42
Setting Frequency Range	42
Zoom	43
CW Frequencies	43
Frequency Resolution	44
Power Level	45
Power Settings	45
Source Unleveled	48
Sweep Settings	49
Sweep Type	49
Power Sweep	52
Segment Sweep	52
X-Axis Point Spacing - Segment Sweep ONLY	56
Arbitrary Segment Sweep	57
Sweep Time	58
Sweep Setup	58
Trigger	61
Trigger Setting	61
External and Auxiliary Triggering	65
Overview	65

See Also.....	68
Data Format.....	72
Display Format.....	72
Rectangular Display Formats	72
Polar Format	74
Smith Chart Format.....	74
Scale.....	77
Scale, Reference Level and Position.....	77
Scale Coupling.....	78
Magnitude Offset.....	80
Customize the VNA Screen.....	81
Labels	82
Grid	84
Toolbars	85
Tools	91
Window Title	94
Trace Title	94
Frequency/Stimulus	95
Minimize Application	95
Copy Channels	96
Why Copy Channels	96
How to Copy Channels	96
List of Channel Settings.....	97
Undo/Redo Settings	99
2. Optimize a Measurement.....	101
Dynamic Range	101
Increase Device Input Power.....	101
Reduce the Receiver Noise Floor.....	101
Phase Measurement Accuracy	103
Electrical Delay	103
Phase Offset	104
Spacing Between Frequency Points (Aliasing).....	104
Electrically-Long Device Measurements	106
Why Device Delay May Create Inaccurate Results.....	106
Solutions to Increase Measurement Accuracy	106
Reflection Accuracy on Low-Loss 2-Port Devices	108
Why Terminate the Unmeasured Port	108
How to Terminate the Unmeasured Port	108
Resulting Measurement Uncertainty.....	108

Measurement Stability	111
Frequency Drift	111
Temperature Drift.....	111
Inaccurate Measurement Calibrations	111
Device Connections	112
Noise Reduction Techniques.....	113
Averaging.....	113
IF Bandwidth	114
Trace Smoothing.....	115
Crosstalk.....	117
Perform an Isolation Calibration	117
Effects of Accessories	118
Power Slope to Compensate for Cable Loss.....	118
Gating to Selectively Remove Responses.....	118
Achieve Fastest Sweep	119
Sweep Settings	119
Noise Reduction Settings	119
Measurement Calibration Choice	119
Unnecessary Functions	120
Switch Between Multiple Measurements.....	121
Set Up Measurements for Increased Throughput	121
Arrange Measurements in Sets	121
Use Segment Sweep	121
Trigger Measurements Selectively	121
Automate Changes Between Measurements	122
Recall Measurements Quickly	122
Data Transfer Speed	124
Using Macros.....	125
Macro Example	127
3. Calibrate a Measurement.....	129
Select a Calibration Type	129
Calibration Wizard	132
SmartCal (Guided Calibration).....	132
Saving a Calibration.....	139
Guided Power Calibration.....	141
Calibrate All Channels	145
Features.....	145
Limitations.....	145
Using Calibration Sets	152

What are VNA Cal Sets	152
Cal Registers and User Cal Sets	152
How to Manage and Apply Cal Sets and Cal Types.....	153
Stimulus Setting Different between Cal Set and Measurement	156
Examples of Cal Set Usage	157
Using one Measurement with many Cal Sets.....	158
Archiving Cal Sets using .cal or .csa files	158
Error Correction and Interpolation	160
Error Correction	160
Viewing Correction Level	160
Interpolation	162
Interpolation Accuracy	162
ECal	163
Using ECal	163
ECal User Characterization	170
Perform a 4-Port Cal with One 2-Port ECal Module	183
TRL Calibration.....	185
Why Perform a TRL Cal?.....	185
The TRL Cal Process.....	185
TRL Cal Kits.....	186
Cal Standards Used in TRL	186
TRL with an External Test Set	187
Power Calibration	188
Source Power Calibration Overview	188
Supported Power Meters and Sensors.....	189
Saving a Source Power Calibration	197
Receiver Power Calibration	197
Saving a Receiver Power Calibration	199
Fixture Simulator	200
Fixture Simulator Example.....	209
Port Extensions	211
Swap Adapters Calibration Method.....	217
Concepts.....	219
Calibration Overview.....	219
Measurement Errors	221
Accurate Measurement Calibrations.....	231
Calibration Thru Methods	234
Validity of a Calibration	238
Calibration Standards	242

Modify Cal Kits	246
Modify Calibration Kits	246
Why Modify a Cal Kit.....	250
About VNA Cal Kits and Firmware Upgrades	251
Creating a New Connector Family	252
How to Create a New Cal Kit from an Existing Cal Kit	254
VNA Cal Kit File Types	255
Connectors Tab	257
Standards Tab	259
SOLT Tab	266
TRL Tab.....	268
4. Analyze Data	271
Markers.....	271
Creating and Moving Markers.....	271
Marker Setup	272
Coupling Method.....	273
Searching with Markers	273
Maximum and Minimum Search	276
Peak Search	277
Multi Peak Search.....	280
Target Search	280
Multi Target Search.....	282
Bandwidth and Notch Search	283
Compression Search	285
About PSAT and PNOP Search	286
Power Saturation (PSAT) Search	286
Power Normal Operating Point (PNOP) Search.....	288
Search Domain	290
Search Range Indicators	290
Marker Functions - Change Instrument Settings	291
Marker Display	292
Marker Table	294
Using Math / Memory Operations.....	296
Trace Math	296
Trace Statistics	298
8510 Mode.....	300
Equation Editor	301
Overview	301
How to start Equation Editor	302

Using Equation Editor	303
Data that is used in Equation Editor	303
Trace Settings, Error Correction and an Example	305
Functions and Constants used in Equation Editor	307
Operators used in Equation Editor	309
Example Equations	310
Saving Equation Editor Data	311
Using Limit Lines	312
Overview	312
Create and Edit Limit Lines	312
Display and Test with Limit Lines	313
Limit Test Setup	314
Saving/Recalling Limit Test Table	315
Displaying Judgement Result of Limit Test	316
Test with Sufficient Data Points	317
Limit Test at certain point	318
5. Output Data	320
Save and Recall a File	320
Save VNA Instrument State and Calibration Files	320
Save VNA Measurement Data	322
Recall a file	324
Instrument State / Calibration Files	326
Measurement Data Files	328
Define Data Saves	335
Manage Files without a Mouse	336
Print a Displayed Measurement	338
Connect a Printer	338
Printing	338
Print to a File	341
Programming	343
Programming Guide	343
SCPI	344
Commands	345
Examples	832
Concepts	852
Rear Panel IO Connectors	881
Interface Control	881
Programming Guide	885
LXI and VXI Compliance	886

LXI.....	886
VXI	886
LAN Status.....	886
Using Macros.....	888
Macro Example	890
Product Support	892
Troubleshooting the VNA	892
Check the Basics	892
Check Error Terms.....	892
Check the Service Guide	893
Error Log Data	893
VNA Error Messages.....	895
About Error Messages.....	947
Analyzer Accessories	950
Coax Mechanical Calibration Kits	950
Waveguide Mechanical Calibration Kits	951
Electronic Calibration (ECal).....	951
Verification Kits	953
Adapters and Accessory Kits.....	953
Test Port Cables	954
USB Peripherals	954
Connector and ESD Supplies	954
82357B USB / GPIB Interface	956
Applications.....	956
Configure the 82357B USB/GPIB Interface.....	956
Connecting the 82357B USB/GPIB Interface	956
Communicating with Equipment Connected to the USB/GPIB Interface	956
Firmware Update	958
Updating Firmware.....	958
Option Enable	959
Instrument Calibration	960
Other Resources	962
Document Resources	962
Third-Party Resources	962
SCPI Errors	963
Technical Support.....	973
Diagnostic Tools and Adjustments.....	974
Display Test	974
Operator's Check	975

System Verification	976
System Settings	986
Configure External Devices	986
Configure an External Device	986
Configure an External Device	990
External Source Configuration	994
Configure a Power Meter As Receiver (PMAR)	998
E5092A Test Set Control	1006
Overview	1006
Connect and Configure the E5092A	1006
Selecting ID for E5092A	1006
Calibrating with the E5092A	1011
About Error Messages	1012
Display Colors	1015
Display Colors	1015
Print Colors	1015
Print Preview Procedure	1018
Frequency Blanking	1019
Interface Control	1022
Overview	1022
GPIB Commands	1024
Power Limit and Power Offset	1026
Overview	1026
Setting System Impedance	1028
Rear Panel IO Connectors	1029
Interface Control	1029
Tutorials	1033
VNA Application Notes	1033
Connector Care	1036
Preventing Test Port Connector Damage	1036
Connector Care and Cleaning Supplies	1037
Safety Reminders	1037
About Connectors	1037
Gaging Fundamentals	1039
Connector Care Procedures	1041
Electrostatic Discharge (ESD) Protection	1045
Measurements	1046
Absolute Output Power	1046
Amplifier Parameters Reference	1048

Table of Contents

Balanced Measurements	1050
Complex Impedance	1057
Comparing the VNA "Delay" Functions	1059
Deviation from Linear Phase	1061
Small Signal Gain and Flatness.....	1064
Group Delay	1066
Phase Measurements	1072
Specifications	1076
Glossary	1077
Glossary	1095
Index.....	1113

Administrative Tasks

VNA User Accounts and Passwords

Important: When the VNA power is switched on, it AUTOMATICALLY logs into Windows using the default user name and password. You do NOT need to log on. This gives anyone full access to the analyzer. The following steps can be taken to increase security of your VNA.

- Require users to logon when the VNA computer is turned ON - [Learn how to enable this feature](#)
- Setup individual accounts on the VNA with varying level of access - Learn how to [Add or Change User Accounts and Passwords](#)

Please read about Anti-virus protection for VNA

Existing User Accounts

The following user accounts already exist on new VNAs.

User Name	Password	Type	Description
Instrument	measure4u	Administrator	Auto Log On is activated by default.
Administrator	Keysight4u!	Built-in Administrator	For user maintenance purpose.
Keysightonly	Not disclosed to user	Administrator	This account is used by Keysight Service in case of repair/maintenance. Do not remove this account.

Note: The user name is not case sensitive. The password is case sensitive.

Note: The VNA local policies are set so that, if logon is required, you must retype the user name (and password) every time. Do not change the local policies on the VNA.

Add or Change User Accounts, Passwords, and Require Logon

If the analyzer is in a secure environment, you can setup VNA users by name and grant various levels of access. This is particularly important when the VNA is remotely controlled or accessed over LAN.

You can designate a person as the administrator and then configure the VNA to allow others to use it with reduced permissions. That is, other people can be signed on to use the analyzer but they will not have the ability to perform all of the administrative functions that you can as the administrator.

Note: To connect and install a new ECal module, you must be logged on with an Administrator account. A user account with limited access will NOT allow an ECal module driver to be loaded. [Learn more.](#)

Learn more about [Microsoft User Account Permissions](#) (internet connection required).

How to add a user account and require logon

Click **Start**, then **Control Panel**

Click **User Accounts**

Click **Manage another account.**

CAUTION: Although allowed by Windows, do NOT allow an Administrator account without a password. Internet viruses look for,

and exploit, this condition.

Click **Create a new account**.

Enter an account name.

Select an account type.

Click **Create Account**.

Name the account and choose an account type

This name will appear on the Welcome screen and on the Start menu.

 Standard user
Standard account users can use most software and change system settings that do not affect other users or the security of the computer.
 Administrator
Administrators have complete access to the computer and can make any desired changes. Based on notification settings, administrators may be asked to provide their password or confirmation before making changes that affect other users.

We recommend that you protect every account with a strong password.
[Why is a standard account recommended?](#)

Note:

A standard user account will NOT allow an ECal module driver to be loaded. [Learn more.](#)

Optional: Click **Create a password** to require the user to enter a password when logging on.

Last Modified:

29-Sep-2015 First Release



Recovering from VNA Solid State Drive Problems

The leading cause of VNA failures is problems with the VNA Solid State Drive (SSD). These problems are usually preventable (see Preventing VNA SSD Problems), and in many cases, recoverable. The following could save you weeks of downtime and the cost of replacing your VNA SSD.

This document is now on the Keysight VNA Support Website: <http://www.keysight.com/find/na>.

If your VNA does experience a Solid State Drive Problem, you will not be able to access this Help file, but you may be able to access the Internet from another computer.

Microsoft Windows Considerations

In this topic:

- [Microsoft Windows on the VNA](#)
 - [LAN Connections](#)
 - [Mouse Configuration](#)
 - [Windows Theme](#)
 - [Printing](#)
-

Microsoft Windows on the VNA

The VNA is shipped from the factory with **Windows® Embedded Standard 7** operating system. This OS supports both 32-bit and 64-bit applications.

VERY IMPORTANT Protect your hard drive!

The leading cause of VNA failures is problems with the VNA Solid State Drive (SSD). These problems are usually preventable and in many cases, recoverable. Learn more about protecting VNA.

Using USB

The VNA has USB ports on the front panel and on the rear panel. The main advantages of USB are “hot” connects and disconnects and fast data transfer speeds. Electronic Calibration modules are also available with USB connections.

The first time you plug a device into a USB port there is some wait time. Windows reports it is identifying the hardware, searching for the correct driver and then installing the driver (if it was found).

Connecting that same device back into that same port later is quick and easy, but if you move the device to a different USB port, you will have to wait through the hardware ID and driver search again.

Learn about USB limitations.

LAN Connections

Windows supports DHCP and fixed IP addressing. Also, “Hot” connect and disconnect of the LAN cable, as well as a visual indicator of LAN status in system tray area, makes LAN connections more intuitive. In addition, the Hardware Wizard helps users with system hardware configuration.

Mouse Configuration

By default, Windows does not allow you to select to make the button on the right the one you use for primary functions such as selecting and dragging. To change any mouse properties, click **Start > Control Panel > Mouse**. In the Mouse Properties dialog box, select any settings that you would like to change, click **Apply** and then click **OK**.

Windows Themes

The VNA application is designed for best viewed in, **Keysight Technologies** theme. To change the theme:

1. [Minimize VNA application.](#)

E5080A

2. Right-click on the Desktop, then click **Personalize**
3. Use the scrollbar and then select a Theme.

Printing

Adding a printer should be done outside of the VNA application. [Learn more.](#)

Last modified:

30-Jun-2014 First release



Quick Start

Powering the VNA ON and OFF

The following is described in this topic:

- [How to Log Off, Shut Down or Restart the VNA](#)
- [ON Mode](#)
- [Shutdown Mode](#)
- [Unplugging the VNA](#)

Notes: During boot up of Windows or of the Network Analyzer application program, do **NOT** press any keys on the front panel, rotate the RPG knob or connect a USB device. Doing so MAY lead to a front panel lockup state. If the VNA front-panel keypad or USB ports are not responding, SHUTDOWN or RESTART the VNA.

Log off, Shut down or Restart the VNA

How to Log off, Shut down or Restart the VNA

1. Minimize the VNA application.
2. Click **Window Start**.
3. There are some action to choose:
 - Log off (closes programs)
 - [Shut down](#)
 - Restart (shutdown and start)

OR

1. Press the front-panel VNA power button (Only for Shutdown)

Note: ONLY if the VNA is locked and you cannot operate the mouse or keypad - Press and hold the power button for at least four seconds. **This practice should be avoided!** Repeated shutdowns in this manner WILL damage the Solid State Drive. Learn more about damaging the VNA hard drive.

ON Mode

- To turn ON the VNA, press the power button.
- The power indicator will change to green when power is ON.

Shutdown Mode

- In shut down mode, the current instrument state is NOT automatically saved before the VNA is powered OFF.
- When the VNA is again powered ON, a full system boot-up is performed and the VNA powers-up in the [preset settings](#).
- A password may be required to resume VNA operation after being in Shutdown mode. [Learn more](#).

- To guarantee that your measurements meet the VNA specified performance, allow the VNA to **warm-up for 90 minutes** after the power indicator has turned green.
- The power indicator will change to orange when power is OFF.

Note: If the VNA is locked and you cannot operate the mouse or keypad, shut down the VNA by pressing and holding the power button for at least four seconds.

This practice should be avoided! Repeated shutdowns in this manner WILL damage the hard drive. Learn more about damaging the VNA hard drive.

Unplugging the VNA

- Remove the power cord from the VNA ONLY when the power indicator is orange, in either Hibernate or Shutdown mode. If the power cord is removed while the power indicator is green (VNA ON), it has high possibility to cause damage the solid state drive.
- The indicator will remain orange for several seconds after the power cord has been removed.

Last Modified:

7-Aug-2014 First Release



Traces, Channels and Windows on the VNA

It is critical to understand the meaning of the following terms as they are used on the VNA.

- [Traces - Managing](#)
 - [Trace Max](#)
 - [Trace Hold](#)
- [Channels - Managing](#)
- [Windows - Managing](#)

Other Quick Start topics

Traces

Traces are a series of measured data points. There is no theoretical limit to the number of traces. However, the practical limit is the [maximum number of windows](#) times the maximum number of traces per window (24). If the traces is exceed the maximum traces per window, it will automatically open another window for the trace.

In addition, one memory trace can be stored and displayed for every data trace. Learn more about [Math/Memory traces](#).

Trace settings affect the presentation and mathematical operations of the measured data.

The following are Trace settings:

- [Parameter](#)
- [Format and Scale](#)
- [Smoothing](#)
- [Correction ON/OFF](#)
- [Electrical Delay](#)
- [Phase Offset](#)
- [Trace Math](#)
- [Markers](#)
- Time Domain (Opt 010)

Managing Traces

- [How to Add a trace](#)
- [How to Select a trace](#)
- [How to Delete a trace](#)
- [How to Move a trace](#)
- [How to Maximize a trace](#)
- [How to Hold a trace at the max or mini point](#)
- [How to display a custom trace title](#) (separate topic)

- How to display a **wide** active trace (separate topic)

How to Add a trace

The only measurements that can be selected are those in the same measurement class as is currently assigned to the channel. To select a measurement other than these, first select the appropriate measurement class to a new or existing channel. [Learn how.](#)

A trace must be selected (active) before its trace settings can be changed.

[How to know which trace is Active?](#)

Using **Hardkey/SoftTab/Softkey**

1. For Traces 1-8, press **Trace** > **Trace 1-8** > click left side **Trace 1-8** small button (Example: Click on left side Trace 1 small button and Trace 1 is active when it turns green color, so Trace 1 added).
2. For Traces 9-16, press **Trace** > **Trace 9-16** > click left side **Trace 9-16** small button (Example: Click on left side Trace 9 small button and Trace 9 is active when it turns green color, so Trace 1 is added).
3. For other traces numbers, press **Trace** > **Trace Setup** > **Add Trace**, then select **New Trace**, **New Trace + Channel**, **New Trace + Window**, **New trace + Channel + Window**, or **Create Traces....**

Using a mouse

1. Right click on the grid box and then select **New Trace...**

Programming Commands

How to Select a trace

The only measurements that can be selected are those in the same measurement class as is currently assigned to the channel. To select a measurement other than these, first select the appropriate measurement class to a new or existing channel. [Learn how.](#)

A trace must be selected (active) before its trace settings can be changed.

Using **Hardkey/SoftTab/Softkey**

1. Press **Trace** > **Trace Setup** > **Select**.
2. Select a trace number which corresponds to the desired measurement parameter.

Using a mouse

1. Click on any trace of [Trace Status](#) label above the grid box.

Programming Commands

How to Delete a trace

Using **Hardkey/SoftTab/Softkey**

1. For Traces 1-8, press **Trace** > **Trace 1-8** > click left side **Trace 1-8** small button (Example: Click on left side Trace 1 small button and Trace 1 is inactive when it is not in green

Using a mouse

1. Right-click the [Trace Status](#) label above the grid box, then click **Delete**

<p>color).</p> <ol style="list-style-type: none"> For Traces 9-16, press Trace > Trace 9-16 > click left side Trace 9-16 small button(Example: Click on left side Trace 9 small button and Trace 9 is inactive when it is not in green color). For other trace numbers, press Trace > Trace Setup > Delete Trace..., then select a trace number. 	<p>Trace...</p>
	

How to Move a trace to a different window

You can **DRAG** a trace from one window to another, or...

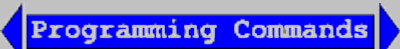
<p>Using <u>Hardkey/SoftTab/Softkey</u></p> <ol style="list-style-type: none"> Press Trace > Trace Setup > Move Trace... Select a window number in the following dialog, and then click OK. 	<p>Using a mouse</p> <ol style="list-style-type: none"> Right-click any trace of Trace Status label above the grid box, then click Move Trace... Select a window number in the following dialog, and then click OK.
	

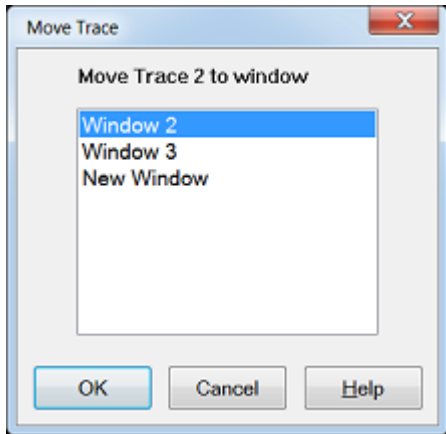

Move Traces Dialog Box Help

Note: Only ONE trace can be move in one time.
 Move Trace N to window - Transfer the selected trace to any Window that listed.

Trace Max

How to maximize the active trace - the ONLY trace on the screen display. All other traces are hidden.

Using Hardkey/SoftTab/Softkey	Using a mouse
<ol style="list-style-type: none"> 1. Press Trace > Trace Setup > Trace Max (ON). With Trace Max (ON), select a different trace to make that trace visible. 2. To make all traces visible again, select Trace Max (OFF). 	<ol style="list-style-type: none"> 1. Right-click the Trace Status label above the grid box, then click Trace Max. 2. Double click on the active trace to make all traces visible again.

Programming Commands

Trace Hold

How to hold the active trace at the maximum or minimum point.

Using **Hardkey/SoftTab/Softkey**

1. Press **Trace > Trace Setup > Trace Hold > OFF | Minimum | Maximum**.
2. **Restart** resets the trace.

No programming are available for this feature

Maximum/Minimum trace hold can be applied with several conditions:

- Feature is applicable to any data trace, not to memory traces.
- When the stimulus or any data post processing setting is changed, the trace hold data will be reset. These settings include:
 - Smoothing on/off.
 - Smoothing Aperture.
 - Gating on/off.
 - Transform on/off.
 - Conversion state change, conversion type change.
 - Data Math Function (Data/Mem) change.
 - Equation Editor state change, formula change.
 - Parameter change.
 - Formatting change.
- Minimum/maximum comparison is done with formatted data. For Smith and Polar formats, absolute data is used and not phase.
- Trace hold data can be recalled.
- Data save files formats
 - SnP: do not save trace hold data
 - Citifile, CSV, MDF, PRN: save trace hold data

Note: Citifiles can be recalled and viewed in the VNA.

- Use SCPI commands to get trace hold data. If trace hold is active, then the data returned from the remote interfaces will be the trace hold data.

Channels

Channels contain traces. Channel settings determine how the trace data is measured. All traces that are assigned to a channel share the same channel settings. The following are channel settings:

- [Frequency range](#)
- [Power level](#)
- Calibration
- [IF Bandwidth](#)
- Number of Points
- [Sweep Settings](#)
- [Average](#)
- [Trigger](#) (some settings are global)

Managing Channels

How to select a channel

A channel must be selected (**active**) before its settings can be changed.

To make a channel active, [select a trace](#) in that channel or click the [Trace Status](#) button of a Trace in that channel

How to Add a channel

Using **Hardkey/SoftTab/Softkey**

1. Press **Channel** > **Channel 1-8** > click left side **Channel 1-8** small button (Example: Click on left side Channel 1 small button and Channel 1 is active when it turns green color, so Channel 1 added).
2. For other channel numbers, press **Channel** > **Channel Setup** > **Add Channel**, then select **New Trace + Channel** or **New Trace + Channel + Window**.

No programming are available for this feature

How to Delete a channel

Using **Hardkey/SoftTab/Softkey**

1. Press **Channel** > **Channel 1-8** > click left side **Channel 1-8** small button(Example: Click on left side Channel 1 small button and Channel 1 is inactive when it is not in green color).
2. For other channel numbers, press **Channel** > **Channel Setup** > **Delete Channel**, then select a channel.

◀ Programming Commands ▶

Windows

Windows are used for viewing traces.

- The VNA can show an **UNLIMITED** number of windows on the screen with the following limitations:
 - The COM property Maximum Number Of Windows returns 1000 ('unlimited' is not a number).
 - The [SCPI status register](#) can only track the status of up to 576 traces.
- Each window can contain up to **24 traces** .
- Windows are completely independent of channels.
- See [Customize the VNA screen](#) to learn how to make other window settings.

The following is a window containing two traces. Both traces use the same channel 1 settings as indicated by the annotation at the bottom of the window.

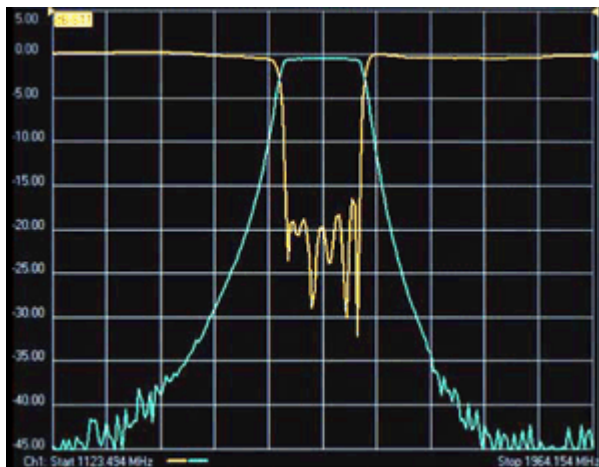

VNA shows the window number in the lower-left corner of the window. The following shows window **5**.



Managing Windows

How to make various window settings

New, Close, Tile, Cascade, Minimize, Maximize

Using **Hardkey/SoftTab/Softkey**

1. Press **Display** > **Window 1-8** > click left side **Window 1-8**

Using a mouse

1. Right-click on any area

small button (Example: Click on left side Window 1 small button and Window 1 is active when it turns green color, so Window 1 added).

- For other windows, press **Display** > **Window Setup** > **Add Window**, then select a **New Window**, **New Trace + Window** or **New Trace + Channel + Window**.

of grid box and then select **New Window**.

Programming Commands

How to Delete a Window

Using **Hardkey/SoftTab/Softkey**

- Press **Display** > **Window 1-8** > click left side **Window 1-8** small button(Example: Click on left side Window 1 small button and Window 1 is inactive when it is not in green color).
- For other windows, press **Display** > **Window Setup** > **Delete Window**, then select a window.

Using a mouse

- Right-click any area of grid box and then select **Close Window**.

Programming Commands

Window Max

How to Maximize the active window - the ONLY window on the screen display. All other windows are hidden.

Using **Hardkey/SoftTab/Softkey**

- Press **Display** > **Window Setup** > **Window Max (ON)**. With Window Max (ON), select a different trace to make that window visible.
- To make all windows visible again, select **Window Max (OFF)**.

Using a mouse

- Right-click any area of grid box and then select **Maximize**.

Programming Commands

Last modified:

29-Sep-2015 First Release



Quick Start Dialog

Quick start is a simple wizard which helps to setup the setting for the typical measurements. This feature allows user to select from a set of pre-configured measurement layouts.

How to Open Quick Start Dialog Box

Using **Hardkey/SoftTab/Softkey**

1. Press **Setup** > **Main** > **Quick Start....**

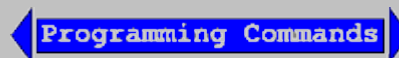

The measurement comprises the following THREE steps.

Step 1: Quick Start Dialog

You are able to select a layout template for typical measurement.

S-Parameter Measurements

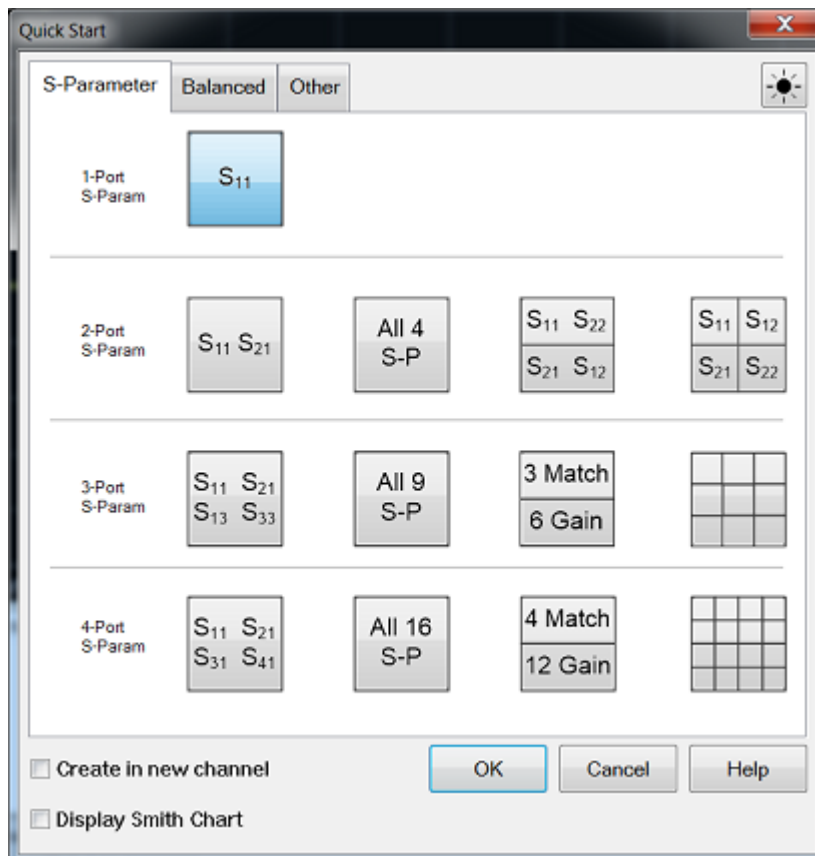

Balanced Measurements

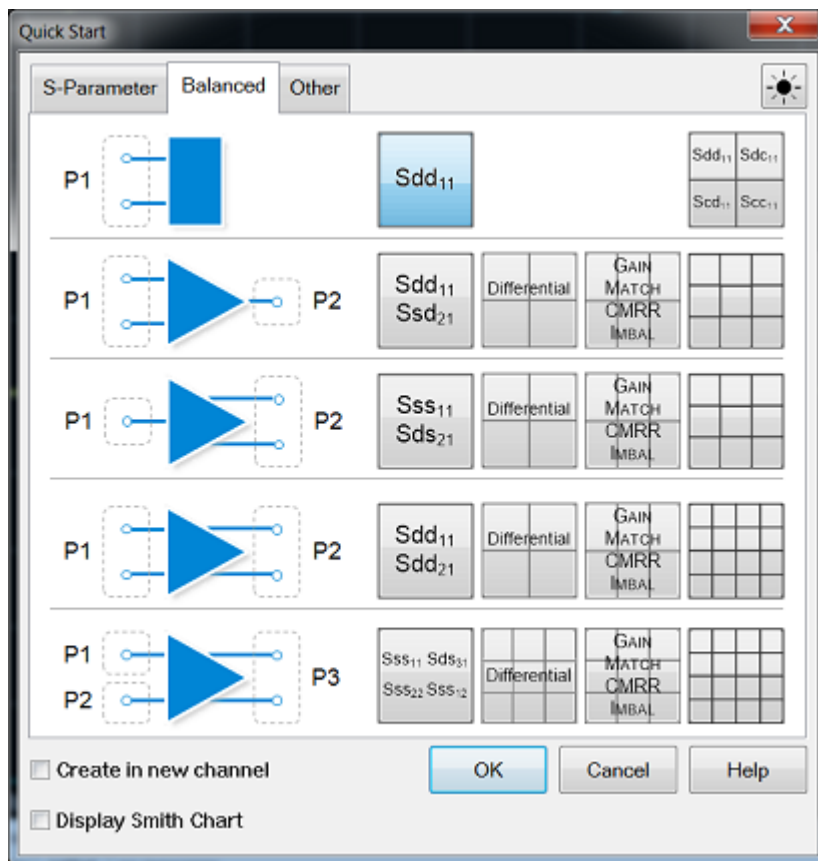

Other Measurements

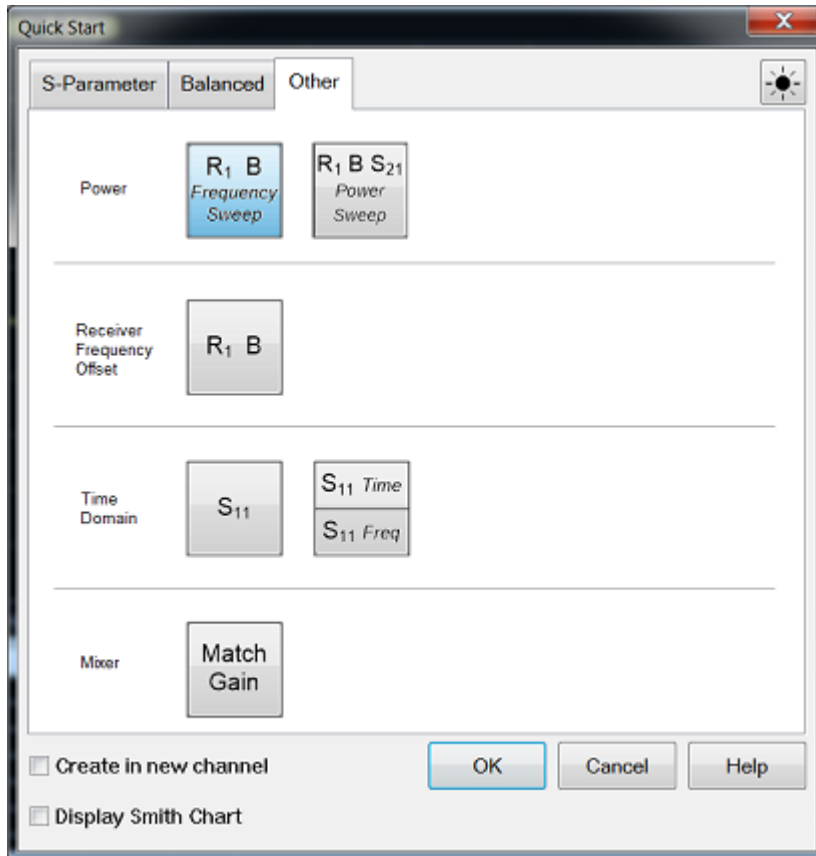



- If "**Create in new channel**" checkbox is enabled, a new channel and window(s) will be created.
- If "**Create in new channel**" checkbox is disabled, when a template is selected then the active channel will be used for the new measurements. If the active trace is displayed in a window with traces on other channels, then the trace will be deleted and a new window(s) will be opened for the new measurements.
- If "**Display Smith Chart**" checkbox is enabled, the active trace in a window will turn to display Smith Chart.
- If "**Display Smith Chart**" checkbox is disabled, no changes on the active trace in a window.

Step 2: Stimulus Settings Dialogs

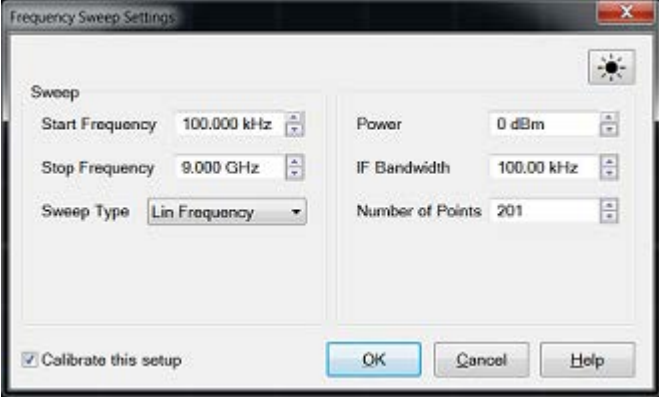
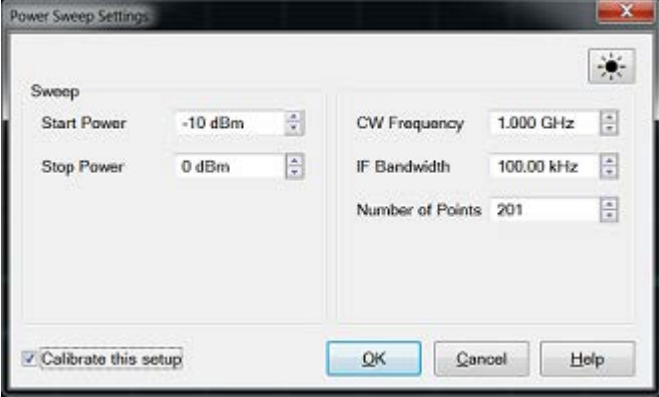
This step is used to set stimulus for the measurement.

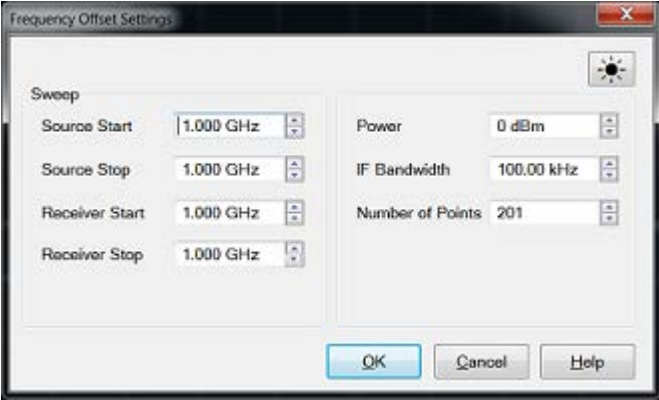
<p>S-Parameter & Balanced</p> <p>Option Required: None</p>	<p>If any one of the following measurement is selected in Step 1, Frequency Sweep Settings dialog will appear.</p> <ul style="list-style-type: none"> • S-parameter measurements • Balanced measurements • Unratioed Receiver measurements  <p>Enter:</p> <ul style="list-style-type: none"> • Start/Stop Frequency • Sweep Type: Lin or Log Frequency • Power • IF Bandwidth • Number of Points <p>Learn more about S-parameter measurements, Differential (Balanced) measurements and Unratioed Receiver measurements.</p>
<p>Power</p> <p>Option Required: None</p>	<p>If any one of Power Sweep measurements is selected in Step 1, Power Sweep Settings dialog will appear.</p>  <p>Enter:</p> <ul style="list-style-type: none"> • Start/Stop Power • CW Frequency • IF Bandwidth

	<ul style="list-style-type: none"> • Number of Points <p>Learn more about Power Sweep measurements.</p>
<p>Receiver Frequency Offset</p> <p>Option Required: 009</p>	<p>If any one of Frequency Offset Measurements (FOM) is selected in Step 1, Frequency Offset Settings dialog will appear.</p>  <p>Enter:</p> <ul style="list-style-type: none"> • Source Start/Stop • Receiver Start/Stop • Power • IF Bandwidth • Number of Points <p>Learn more about FOM.</p>

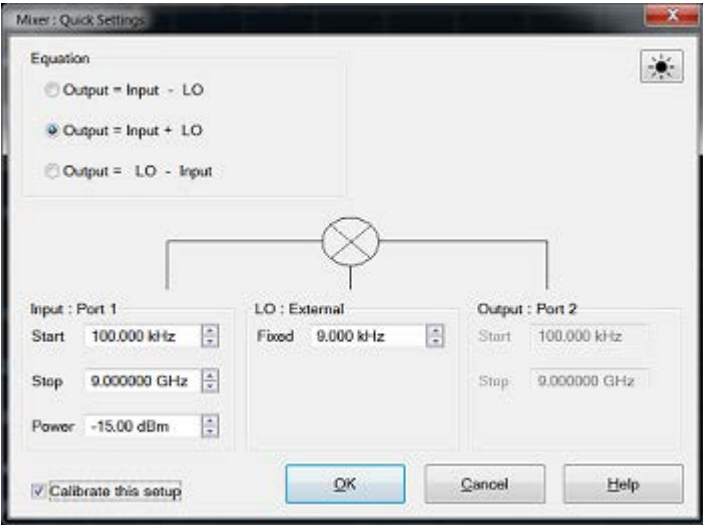
<p>Time Domain</p> <p>Option Required: 010</p>	<p>If any one of Time Domain measurements is selected in Step 1, Time Domain Settings dialog will appear.</p>  <p>Enter:</p> <ul style="list-style-type: none"> • Start/Stop Time • Transform Mode (Time Domain Settings dialog auto-select the start frequency if a LPF transform mode is selected.) • Start/Stop Frequency • Power • IF Bandwidth • Number of Points <p>Learn more about Time Domain measurements.</p>
<p>Mixer</p> <p>Option Required: 009</p>	<p>If any one of SMC Measurements is selected in Step 1, Mixer Quick Settings dialog will appear.</p>  <p>Enter:</p> <ul style="list-style-type: none"> • Equation: Output = Input - LO, Output = Input + LO, Output = LO - Input

	<ul style="list-style-type: none">• Input, LO and Output Frequencies and configuration. <p>Learn more about SMC Measurements</p>
--	--

Steps 3: Cal Wizard Dialog (Optional)

If "**Calibrate this setup**" checkbox is enabled, the Cal Wizard Dialog will appear when Stimulus Settings Dialog is dismissed with the "OK" button.

If "**Calibrate this setup**" checkbox is disabled, the Cal Wizard Dialog will NOT appear.

Cal Wizard functions:

- [Smart Cal Wizard](#)
- SMC Cal Wizard

Last modified:

29-Sep-2015 First Release

Frequency Blanking

For security reasons, you can prevent frequency information from appearing on the VNA screen and printouts.

How to set Frequency Blanking

Using **Hardkey/SoftTab/Softkey**

1. Press **System** > **Main** > **Security...**

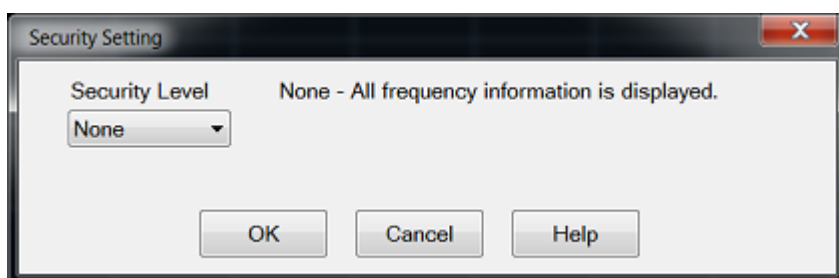
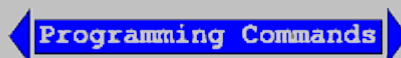

Security Setting Dialog Box Help

Notes:

- To learn how to erase memory before moving VNA out of a secure area, see <http://na.tm.Keysight.com/pna/security.html>.
- An ECal Data Wipe Utility destroys all user data per US DoD 5220.22-M. Learn more at <http://na.tm.Keysight.com/pna/apps/applications.htm>
- VNA 'Undo' is disabled with **High** and **Extra** security levels. [Learn more.](#)

Security Levels

None - All frequency information is displayed.

Low - No frequency information is displayed. Return to this dialog box to re-enable display of frequencies.

Frequency information is blanked from the following:

- Display annotatio
- Calibration properties
- All tables
- All toolbars
- All printouts
- [External sources](#) - See Also: Preference to Deactivate External Devices on Preset

Note: Frequency Blanking is fully supported ONLY on Keysight MXG sources with option 006. On MXG models without option 006 and all PSG models, the window state is turned OFF. When the "local" button is clicked on the source, then frequency is re-displayed.

High - No frequency information is displayed. Only Preset or recall of instrument state can re-enable display of frequencies.

Low security level settings PLUS:

- [GPIB console](#) is inactive.

Extra - Frequency information is not displayed and will not be saved to ASCII file types. Only Preset or recall of instrument state can re-enable display of frequencies.

High security level settings PLUS:

- All ASCII [data saving](#) capability (.snp, .prn, .cti) is saved without frequency information. The X-axis information is replaced with data point numbers.
- Mixer setup files (*.mxr) can NOT be saved.

For ALL security levels:

Frequency information is **NOT** blanked from the following:

- Service Adjustment Programs.
- SCPI programs.

Instrument State and Cal Sets

The security level is always saved and recalled with an instrument state. However, the instrument state may contain a Cal Set or link to a Cal Set. [Learn more](#). This may influence the security level when the instrument state is recalled.

- When a new Cal Set is created at the end of a calibration, the current system security level is stored with it.
- The only way to change an existing Cal Set's security level is by writing a new calibration into the Cal Set.
- When later applied to a channel, if the Cal Set has a **higher** security level than the current system security level, the system security level will become upgraded to that of the Cal Set.
- When saving an instrument state to either a *.csa or *.cst file, the security levels of the system and Cal Set are saved separately. When recalled, the higher security level of the two is applied.
- To view the security level of a Cal Set, see [Cal Set Properties](#).

Re-displaying frequency information

- When in **Low** security level, do any of the following:
 - Revisit this dialog box and select **None**.
 - Perform an [instrument preset](#).
 - Recall an Instrument State/Cal Set with security level of **None**.
- When in **High** or **Extra** security level, do any of the following:
 - Perform an [instrument preset](#).
 - Recall an Instrument State/Cal Set with security level of **None**.

Last Modified:

29-Sep-2015 First Release

VNA Connectivity Guide

The VNA as a PC

- [VNA User Accounts and Passwords](#)
- [Using VNC to Control the VNA User Interface](#)

GPIB Programming

- [Configure for GPIB, SCPI and SICL](#)

Controlling External Devices

- [Configure an External Device](#)
- [E5092 Test Set Control](#)
- [Interface Control Feature](#)

Using VNC to Control the VNA User Interface

VNC (Virtual Network Computing) allows you to control the User Interface of a VNA from any PC. The VNA display appears on the connected PC display. Mouse and keyboard control can occur from both the VNA and PC, although not simultaneously.

Note: For similar functionality, use Windows **Remote Desktop**. see the Windows help file for more information.

Both the VNA and PC must be connected to the same network. The responsiveness of the VNA while using VNC is dependent of the speed of your internet connection.

Every VNA is shipped with VNC installed. However, you must download and install the VNC software onto the PC.

The following procedures can help you configure VNC to view and control the VNA application from your PC.

On the VNA, run VNC Server

To do this:

1. Click View, then Minimize Application.
 2. Click **Start**, then **All Programs**, then **TightVNC**, then **Tight VNC Server (Application Mode)**, then **Launch VNC Server**.
- When the server is running, the  icon is visible in the lower right corner of the display. If not visible, click the up arrow to expand the list of icons.
 - The first time you run VNC Server, you must first set a password to control access from remote PCs.

On the PC, run VNC Viewer

To do this:

1. Download from <http://www.tightvnc.com/> and install TightVNC on the PC.
2. From the PC Desktop, click **Start**, then **Programs**, then **TightVNC**, then **TightVNC Viewer**
3. When prompted for the Hostname, type the full computer name or IP address of the VNA.
4. When prompted for the password, type the password you set when configuring VNC on the VNA.

Last Modified:

25-Jul-2014 First Release

LXI and VXI Compliance

The VNA products are LXI and VXI compliant.

LXI

Learn more about LXI at <http://www.lxistandard.org/>

VXI

Learn more about VXI at <http://www.vxi.org/>

LAN Status

When a LAN connection is used with the VNA, the LAN Status dialog allows you to see the IP address and other LAN connection properties.

How to view LAN Status

<p>Using Hardkey/SoftTab/Softkey</p> <ol style="list-style-type: none"> 1. Press System > System Setting > Lan Status.... 	<p>Using a mouse</p> <ol style="list-style-type: none"> 1. Right click on the LCL (or RMT) icons on the status bar. 2. Select on Lan Status....
---	---



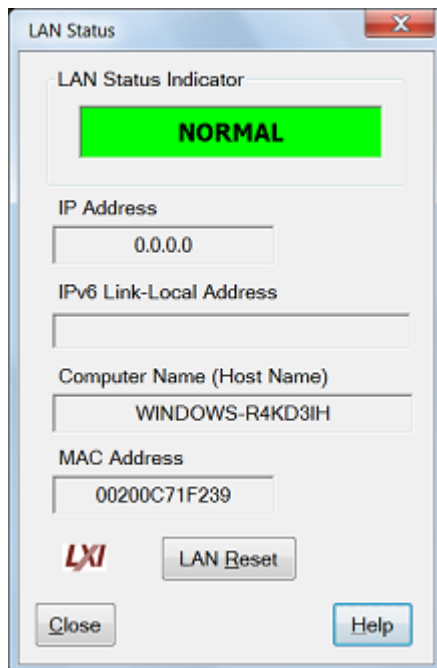

LAN Status dialog box help

Indicator Shows the current status of the LAN connection.

NORMAL - Indicates that the VNA LAN is ready for communication.

IDENTIFY - Indicates that a remote computer has invoked an LXI identification operation on the VNA using the web-based interface or LXIDeviceIDState COM property.

FAULT - Indicates that the VNA LAN interface is not connected to the Internet.

IP Address Shows the current IPv4 address of the VNA

IPv6 Link-Local Address Shows the current IPv6 address of the VNA

Computer Name Shows the full computer name of the VNA. Learn how to change this. If you see the IP address listed here, that means there is no DNS server specified in the network setup.

MAC Address Shows the unique address of the VNA computer. Also known as HostID.

LAN Reset Provides a LAN Configuration Initialize (LCI) mechanism. Press to return the following settings to factory default conditions:

- **IP Address Configuration (DHCP):** Enabled
- **ICMP Ping Responder:** Enabled
- **Web Password for configuration:** Resets the password to 'Keysight'.

Web Server Software

If your VNA is LXI Class C compliant ([see above](#)), you can connect to the VNA using a web browser over an internet connection.

To do this, when the above dialog indicates a **NORMAL** condition:

1. From a web browser, type **http://<your_VNA_computer_name>**. For example, to connect to the fictitious VNA in the dialog above, type: **http://WINDOWS-R4KD3IH**
2. You will see the welcome screen with connection links.

Last modified:

29-Sep-2015 First Release

Using Help

This topic discusses the following:

- [VNA Documentation](#)
- [Launching Help](#)
- [Searching Help](#)
- [Documentation Warranty](#)

See Also

[Help, About Network Analyzer](#)

Other Quick Start Topics

VNA Documentation

This Help file, which is embedded in the VNA, is the **Users Guide and Programming Manual for the VNA**. The help file is automatically updated on the VNA when firmware is updated. Only the VNA [Installation and Quick Start Guide](#) is shipped with new VNA instruments.

Hardcopy manuals are no longer available for purchase with the VNA.

All VNA documentation, including the **latest online Web Help version** of this Help file, and a printable .PDF version of the Help file, are available at <http://www.keysight.com/find/na>.

Launching Help

The Help system can be launched in three ways:

1. From the front panel Help button.
2. From the **Help** drop-down menu
3. From Dialog Box Help

Searching Help

TIP: To Search any topic for a keyword, press **Ctrl** and **F**.

[Perform a Google search of the online version of VNA Help.](#)

The following rules apply for using full-text search:

- Searches are not case-sensitive.
- You can search for any combination of letters (a-z) and numbers (0-9).
- Punctuation marks (period, colon, semicolon, comma, and hyphen) are ignored during a search.
- You can group the words of your search using double quotes or parentheses. Examples: "response calibration" or (response calibration). This requirement makes it impossible to search for quotation marks.
- Use Wildcard expressions:
 - To search for one undefined character use a question mark (?). For example, searching for **cal?** will find **calc** and **calf**.

- To search for more than one undefined character use an asterisk (*). Searching for **Cal*** will find **calibration** and **calculate**.
- Use Boolean operators to define a relationship between two or more search words.

Search for	Example	Results will show topics containing:
Two words in the same topic	response AND calibration	Both the words "response" and "calibration".
Either of two words in a topic	response OR calibration	Either the word "response" or the word "calibration" or both.
The first word without the second word in a topic	response NOT calibration	The word "response" but not the word "calibration".
Both words in the same topic, close together.	response NEAR calibration	The word "response" within eight words of the word "calibration".

Documentation Warranty

THE MATERIAL CONTAINED IN THIS DOCUMENT IS PROVIDED "AS IS," AND IS SUBJECT TO BEING CHANGED, WITHOUT NOTICE, IN FUTURE EDITIONS. FURTHER, TO THE MAXIMUM EXTENT PERMITTED BY APPLICABLE LAW, KEYSIGHT DISCLAIMS ALL WARRANTIES, EITHER EXPRESS OR IMPLIED WITH REGARD TO THIS MANUAL AND ANY INFORMATION CONTAINED HEREIN, INCLUDING BUT NOT LIMITED TO THE IMPLIED WARRANTIES OF MERCHANTABILITY AND FITNESS FOR A PARTICULAR PURPOSE. KEYSIGHT SHALL NOT BE LIABLE FOR ERRORS OR FOR INCIDENTAL OR CONSEQUENTIAL DAMAGES IN CONNECTION WITH THE FURNISHING, USE, OR PERFORMANCE OF THIS DOCUMENT OR ANY INFORMATION CONTAINED HEREIN. SHOULD KEYSIGHT AND THE USER HAVE A SEPARATE WRITTEN AGREEMENT WITH WARRANTY TERMS COVERING THE MATERIAL IN THIS DOCUMENT THAT CONFLICT WITH THESE TERMS, THE WARRANTY TERMS IN THE SEPARATE AGREEMENT WILL CONTROL.



Help - About Network Analyzer

Click [Help](#) > [Help](#) > [About NA...](#), then **About Network Analyzer** to learn the following about your VNA:

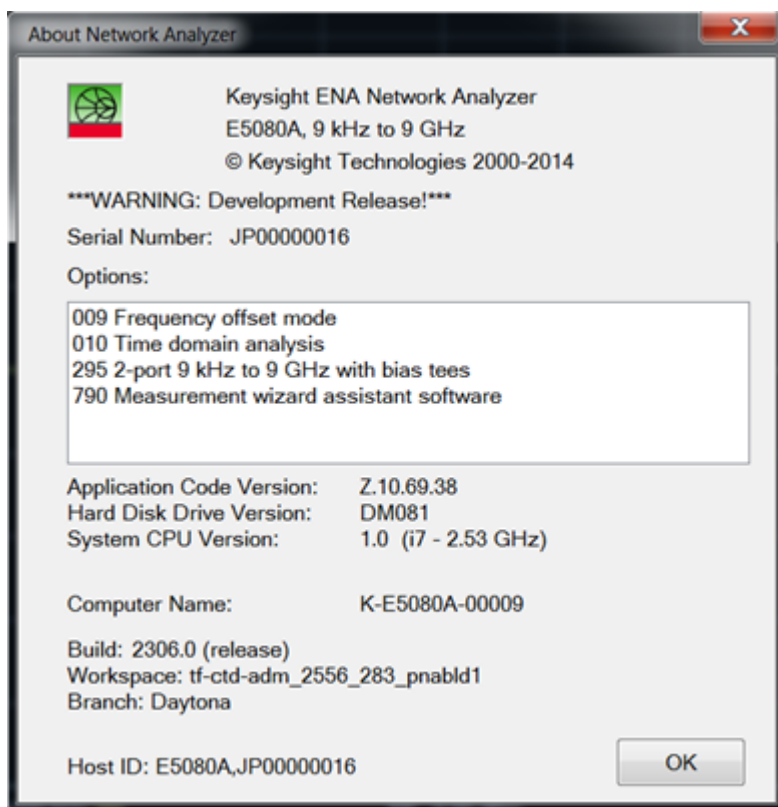
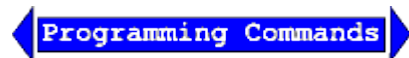

- Model number
- Frequency range
- Serial number
- Installed options ([Learn how to install software options](#))
- Application Code (firmware) Version
- Solid State Drive Version
- System CPU Version - [Learn more](#)
- DSP (Digital Signal Processor.) Version. This is not used for the E5080A.
- Computer Name - [Learn more](#). This is also reported on the [LAN Status / LXI Compliance dialog](#).

Last Modified:

30-Nov-2009 First Release

E5080A

Search VNA Help

Search is limited to <http://na.tm.Keysight.com/pna/help/latest/>

[See Google Search Help](#)

1. Set Up a Measurement



Preset the VNA

When you Preset the VNA, it is set to known, or preset conditions. You can use the factory default preset conditions, or define your own User Preset conditions.

- [Preset \(Default\) Conditions](#)
- [User Preset Conditions](#)

See other 'Setup Measurements' topics

Preset Default Conditions

How to Preset the VNA

Tip: Press the **Preset** button to start the VNA application if it is not already running.

Using **Hardkey/SoftTab/Softkey**

1. Press **Preset** > **Main** > **Preset**.

When **Confirm Preset** is Off,

1. Press **Preset**.

◀ Programming Commands ▶

User Preset Conditions

The analyzer can be preset to either factory default conditions or User Preset conditions.

How to set User Preset

Using **Hardkey/SoftTab/Softkey**

1. Press **Preset** > **Main** > **User Preset....**

◀ Programming Commands ▶

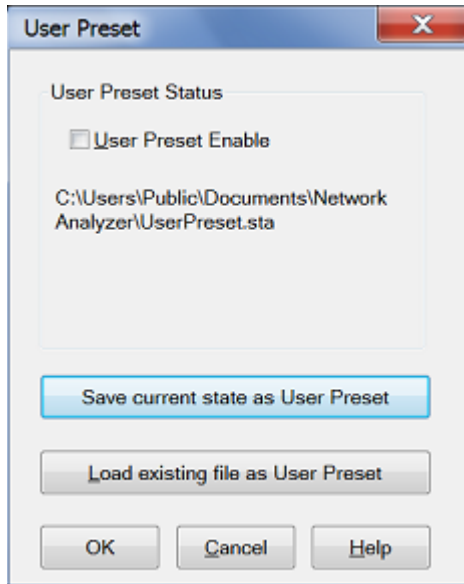

User Preset dialog box help

With a User Preset saved and enabled, when the VNA is Preset, the User Preset settings are recalled instead of the factory default settings. Calibration data is NOT recalled with a User Preset. [Learn more about instrument state settings.](#)

User Preset Enable

Check - The VNA is preset to **User Preset** conditions when the Preset button is pressed.

Clear - The VNA is preset to **Default** conditions when the Preset button is pressed.

Save current state as User Preset - Click to store the current instrument state as the User Preset conditions. File is stored as D:\UserPreset.sta.

Load existing file as User Preset - Click to retrieve an instrument state to be used as the User Preset conditions.

Last modified:

1-Jul-2014 First release

Measurement Classes

Measurement Classes are categories of measurements that can coexist on a channel.

- [What are Measurement Classes](#)

See other 'Setup Measurements' topics

What are Measurement Classes

The following table shows the Measurement Classes currently available for the VNA. Within each of these classes there are a number of measurements.

Measurement Classes are categories of measurements that can coexist on a channel. A measurement from one class can NOT reside in a channel with a measurement from another class. For example, a Noise Figure measurement can NOT reside in a channel that is currently hosting Scalar Mixer Measurements.

The Measurement Class dialog is accessed in the following ways:

How to assign a Measurement Class to a Channel

Using **Hardkey/SoftTab/Softkey**

1. Press **Meas** > **Meas Overview** > **Measurement Class** > **Measurement Class...**

◀ **Programming Commands** ▶

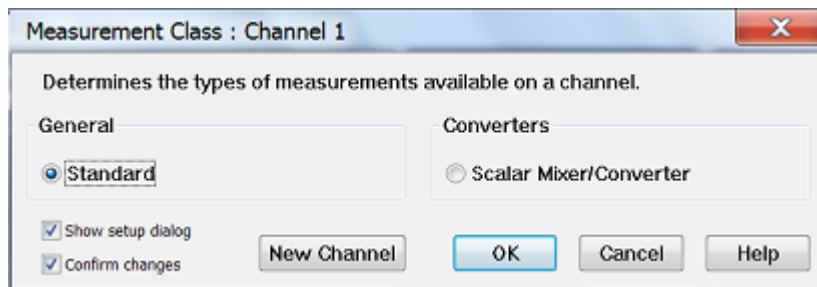

Measurement Class dialog box help

Measurements in a measurement class can NOT coexist in a channel with a measurement of a different measurement class.

Select a measurement class for the active channel or new measurement channel.

- The **Standard** measurement class contains S-Parameters. Balanced parameters, and Receiver measurements.
- All other measurement classes are commonly called "**Applications**".

Title Bar Indicates the active channel to which the measurement class will be assigned.

Show setup dialog shows the dialog box to set the stimulus.

Confirm changes

- Check (default setting) to launch the Confirm Measurement Class Change dialog.

- Clear to perform the 'OK' actions without confirmation. This setting survives a Preset and VNA Shutdown.

New Channel Click to create the measurement class in a new channel and new window. A default measurement for that class is created in the channel.

To change the measurement, click **Trace**, then select a new measurement.

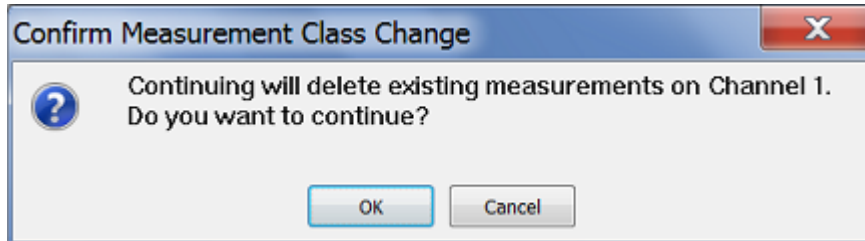

Choose to do the following:

- **OK** - Delete the existing measurements in the active channel. Create the new measurement class, and default measurement, in that channel.
- **Cancel** - Do not create the new measurement class. Leave the old measurements (and class) in that channel and return to the Measurement Class dialog box.

Last Modified:

2014-06-28

First release

Measurement Parameters

This topic contains the following information:

- [S-Parameters](#) (pre-selected ratios)
- [Balanced](#)
- [Receivers](#)
- [Ratioed](#) (choose your own ratio)
- [Unratioed Power](#) (absolute power)
- [Auxiliary](#)

[Learn about Balanced Measurements](#)

See other 'Setup Measurements' topics

S-Parameters

S-parameters (Scattering Parameters) are used to describe the way of a device modifies a signal. An S-parameter is defined by the ratio of two complex numbers and contains information on the magnitude and phase of the signal.

For a 2-port device, there are **four S-Parameters**. The syntax for each parameter is described by the following:

S_{out - in}

out = VNA port number where the device signal output is measured (receiver)

in = VNA port number where the signal is applied (incident) to the device (source)

Move the mouse over each S-parameter to see the signal flow:

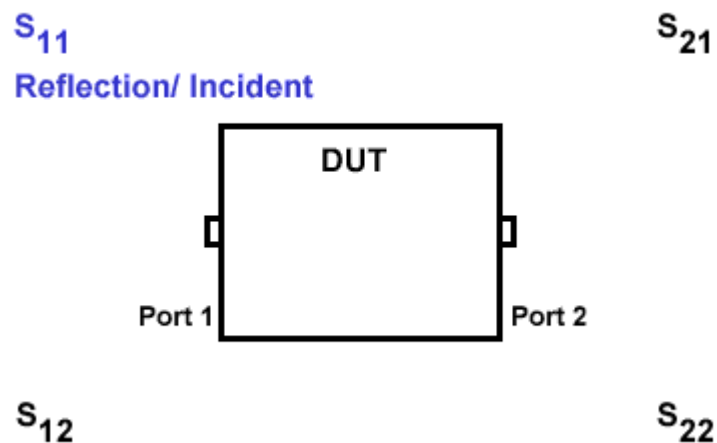

For two-port devices:

- When the source goes into port 1, the measurement is said to be in the **forward** direction.
- When the source goes into port 2, the measurement is said to be in the **reverse** direction.

The analyzer automatically switches the source and receiver to make a forward or reverse measurement. Therefore, the analyzer can measure all four S-parameters for a two-port device with a single connection.

Common Measurements with S-Parameters

Reflection Measurements (S₁₁ and S₂₂)

- Return loss
- Standing wave ratio (SWR)
- Reflection coefficient
- Impedance
- S₁₁, S₂₂

Transmission Measurements (S₂₁ and S₁₂)

- Insertion loss
- Transmission coefficient
- Gain/Loss
- Group delay
- Deviation from linear phase
- Electrical delay
- S₂₁, S₁₂

Receiver Measurements

All VNA models have test port receivers and reference receivers.

For 4-port models

- R1, R2, R3 and R4 are reference receivers. They measure the signal as it leaves the VNA source.
 - R1 measures the signal out of Port 1
 - R2 measures the signal out of Port 2
 - R3 measures the signal out of Port 3
 - R4 measures the signal out of Port 4
- A, B, C and D are test port receivers. They measure the signal out (or reflecting off) of the DUT.
 - A measures the signal into VNA Port 1
 - B measures the signal into VNA Port 2
 - C measures the signal into VNA Port 3
 - D measures the signal into VNA Port 4

Receivers can also be specified using Logical Receiver Notation. [Learn more](#).

Ratioed Measurements

Ratioed measurements allow you to choose your own ratio of any two receivers that are available in VNA. S-parameters are actually pre-defined ratio measurements. For example S₁₁ is A/R1.

The following are common uses of ratioed measurements:

- Comparing the phase between two paths of a device. An example could be something simple like a power splitter or more complicated like a dual-channel receiver.
- Measurements that require a higher dynamic range than the analyzer provides with S-parameters.

Unratioed (Absolute Power) Measurements

The unratioed power parameter measures the absolute power going into any of the receivers that are available on VNA.

The reference receivers are internally configured to measure the source power for a specific VNA port. Performing an absolute power measurement of a reference receiver using a different source port will measure very little power unless the front panel jumpers are removed and signal is applied directly to the receiver. An example of this would be an R1 measurement using port 2 as the source.

- [Measuring phase](#) using a single receiver yields meaningless data. Phase measurements must be a comparison of two signals.
- Averaging for Unratioed parameters is computed differently from ratioed parameters. [Learn more.](#)
- Choose Response Cal if ONLY unratioed parameters are being measured. If S-parameters are also being measured, then SmartCal will calibrate the test port receivers in use.

New Trace / Measure Dialog Box Help

Note: The only measurements that are available are those in the [measurement class](#) currently assigned to the active channel. Other measurements are NOT compatible.

To create a measurement other than these, first assign the appropriate measurement class to a new or existing channel. [Learn how.](#)

Click a tab to create or change measurements.

- When creating NEW measurements, you can choose more than one.
- When changing an EXISTING measurement, you can choose ONLY one.

Tabs

S-Parameter - Select a predefined ratioed measurements. Learn more about [S-parameters.](#)

S-Parameter	Balanced	Receivers	
<input type="checkbox"/> S11	<input type="checkbox"/> S12	<input type="checkbox"/> S13	<input type="checkbox"/> S14
<input type="checkbox"/> S21	<input type="checkbox"/> S22	<input type="checkbox"/> S23	<input type="checkbox"/> S24
<input type="checkbox"/> S31	<input type="checkbox"/> S32	<input type="checkbox"/> S33	<input type="checkbox"/> S34
<input type="checkbox"/> S41	<input type="checkbox"/> S42	<input type="checkbox"/> S43	<input type="checkbox"/> S44

ement type. (Multiport VNAs ONLY)

Change - Click to invoke the [Balanced DUT Topology/Logical Port mappings](#) dialog box. Learn more about [Balanced Measurements.](#)

S-Parameter	Balanced	Receivers
<input type="checkbox"/> Sss11	<input type="checkbox"/> Ssd12	<input type="checkbox"/> Ssc12
<input type="checkbox"/> Sds21	<input type="checkbox"/> Sdd22	<input type="checkbox"/> Sdc22
<input type="checkbox"/> Scs21	<input type="checkbox"/> Scd22	<input type="checkbox"/> Scc22
<input type="checkbox"/> Imbal	<input type="checkbox"/> $\frac{Sds21}{Scs21}$	<input type="checkbox"/> $\frac{Ssd12}{Ssc12}$
Topology / Mapping / Stimulus SE:1 BAL: 2-3 Single End <input type="button" value="Change"/>		

Receivers - Select receivers to make Ratioed and Unratioed (absolute power) measurements. Learn more about [Receiver Measurements](#).

S-Parameter	Balanced	Receivers	
Activate: <input checked="" type="checkbox"/>	Numerator: A	Denominator: 1.0	Source Port: Port 1
Activate: <input type="checkbox"/>	Numerator: B	Denominator: 1.0	Source Port: Port 1
Activate: <input type="checkbox"/>	Numerator: C	Denominator: 1.0	Source Port: Port 1
Activate: <input type="checkbox"/>	Numerator: D	Denominator: 1.0	Source Port: Port 1
Activate: <input type="checkbox"/>	Numerator: R1	Denominator: 1.0	Source Port: Port 1
Activate: <input type="checkbox"/>	Numerator: R2	Denominator: 1.0	Source Port: Port 2
Activate: <input type="checkbox"/>	Numerator: R3	Denominator: 1.0	Source Port: Port 3
Activate: <input type="checkbox"/>	Numerator: R4	Denominator: 1.0	Source Port: Port 4

Ratioed - Check **Activate** to create or change a measurement. Select a receiver for the Numerator, select another receiver for the Denominator, then select a source port for the measurement.

The **Source port** is ALWAYS interpreted as a logical port number.

For convenience, the table is populated with common choices.

- Learn more about External Test Sets and Ratioed Measurements.
- Learn more about [Ratioed Measurements](#).

Unratioed - Same as Ratioed, but select 1 as the Denominator.

- Learn more about [Unratioed Measurements](#).

Receiver Notation

Receivers can be also selected using logical receiver notation. This "8510-style" notation makes it easy to refer to receivers with an External Test Set connected to the VNA.

- **aN** - Reference receiver for logical port N
- **bN** - Test port receiver for logical port N
- **AIN** - Analog AUX In N (1 or 2)

For example:

- For **Ratioed** measurements: "b12/a1" refers to the logical test port 12 receiver / the logical port 1 reference receiver.
- For **Unratioed** measurements: "b10" refers to the logical test port 10 receiver.
- For **Auxiliary** measurements: "AI1" refers to AUX IN 1 (ANALOG IN) on the rear panel.

The new style notation (A, B, R1 and so forth) can still be used to refer to the VNA **physical** receivers. [Learn more.](#)

However, ratioed measurements **MUST** use the same notation to refer to both receivers; either the physical receiver notation (A, R1) or the logical receiver notation (aN, bN). For example, the following mixed notation is **NOT** allowed: A/b3 and a5/R2.

Programming

When entering receiver letters using programming commands, neither logical or physical receiver notation are case sensitive.

Auxiliary - Select the input of AUX 1 or 2 on the rear panel.

- AUX port can make a DC measurement.
- Select the DC range at either 1 V or 10 V by pressing **Meas > Auxiliary > AuxIn1 Range or AuxIn2 Range.**

Channel / Window Selections

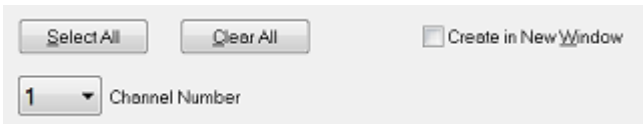

These selections are **NOT AVAILABLE** when changing an **EXISTING** measurement. [Learn how to change a measurement.](#)

Channel Number - Select the channel for the new traces.

Create in New Window

- Check to create new traces in a new window.
- Clear to create new traces in the active window. When the VNA [traces per window limitation](#) has been reached, no more traces are added.

[About Measurement Parameters](#) (top of page)

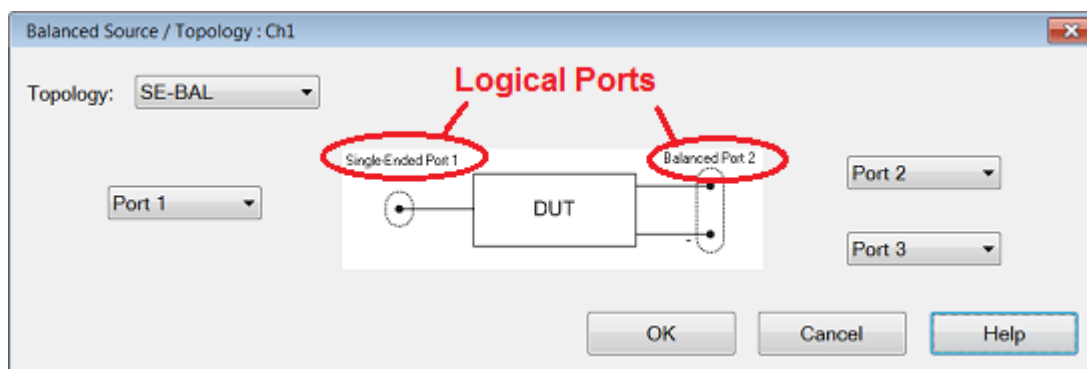

Balanced DUT Topology / Logical Port mappings Dialog Box Help

Create or edit DUT Topology and Logical Port Mapping.

A Logical Port is a term used to describe a physical VNA test port that has been remapped to a new

port number.

- Any **Two** physical VNA ports are mapped to **One Balanced** Logical port
- Any **One** VNA physical port is mapped to **One Single-Ended** Logical port.

Note: These selections apply to ALL measurements in the channel. If the device topology is changed, any existing measurements in the channel that are incompatible with the new topology will be automatically changed to one that is compatible.

Topology: Describes your DUT as you would like it tested. The following device topologies can be measured by a multiport VNA. When the unit is 2-port model, only balanced can be selected.

- **Balanced**
(1 logical ports - <2 actual ports>)
- **Balanced/Balanced**
(2 logical ports - <4 actual ports>)
- **Single-ended/Balanced**
(2 logical ports - <3 actual ports>)
- **Single-ended - Single-ended/Balanced**
(3 logical ports - <4 actual ports>)

These topologies can be used in the reverse (<==) direction to measure:

- **Balanced/Single-ended - Single-ended** topology

For example, to measure a **Balanced/Single-ended** topology, measure the S12 (reverse direction) of a **Single-ended/Balanced** topology.

- Learn about Logical Port mapping when using an External Test Set.
- Learn more about [Balanced Measurements](#)
- Balanced parameters can be saved to SNP files. [Learn more.](#)

Last modified:

29-Sep-2015 First Release



Frequency Range

Frequency range is the span of frequencies you specify for making a device measurement.

- [Setting Frequency Range](#)
- [Zoom](#)
- [CW Frequencies](#)
- [Frequency Resolution](#)

See other 'Setup Measurements' topics

Setting Frequency Range

How to set Frequency Range	
<p>Using Hardkey/SoftTab/Softkey</p> <ol style="list-style-type: none"> 1. Press Freq > Main > Start, Stop, Center or Span. 2. Enter desired frequency value. 	<p>Using a mouse</p> <ol style="list-style-type: none"> 1. Right click on the X-axis label or stimulus range area under grid line. 2. Click on Start/Stop/Center....
<p>◀ Programming Commands ▶</p>	

There are two ways to set the frequency range:

- A. Specify the **Start** and **Stop** frequencies of the range.
- B. Specify the **Center** frequency and desired **Span** of the range.

See the frequency ranges of all VNA models.

Start, Stop, Center, Span Dialog Box Help

Start - Specifies the beginning frequency of the swept measurement range.

Stop - Specifies the end frequency of the swept measurement range.

Center - Specifies the value at the center of the frequency sweep. This value can be anywhere in the analyzer range.

Span - Specifies the span of frequency values measured to either side of the center frequency.

Points - Specifies number of measurement points.

Step - Specifies the step.

Zoom

Zoom allows you to easily change the start and stop frequencies or start and stop power levels in a [power sweep](#).

Zoom operates on the [Active Trace](#) and all traces in the same channel as the active trace, regardless of the window in which they appear.

How to Zoom in a measurement window

1. Left-click the mouse or use a finger, then drag across a portion of a trace.
2. Release the mouse or lift the finger and the following menu appears:

Select from the following:

- **Zoom** - changes the channel stimulus settings to the left and right border values of the Zoom selection.
- **Zoom xy** - changes the channel stimulus settings as above. In addition, the Y-axis scale of the active trace changes to the approximate scale of the Zoom selection.
- **Zoom Full Out** - changes the channel stimulus settings to the full span of the current calibration. If no calibration is ON, then the stimulus settings are changed to the full span of the VNA model.

Notes:

- The stimulus settings are changed for **ALL** traces in the active channel, regardless of the window in which they appear.
- If markers are in the selected area, they remain in place.
- If markers are in the unselected area, they are moved to the right or left edge of the new span. When Zoom Full Out is selected, the markers are moved back to their original location.

Zoom is NOT available for the following:

- Smith Chart or Polar [display formats](#)
- [CW Time](#) and [Segment sweep type](#)
- Frequency Offset Measurements

CW Frequencies

Measurements with a [CW Time sweep](#) or [Power sweep](#) are made at a single frequency rather than over a range of frequencies.

How to set CW Frequency

Using **Hardkey/SoftTab/Softkey**

Using a mouse

1. Set [Sweep Type](#) to **CW Time** or **Power Sweep**.
2. Press **Freq** > **Main** > **CW**.
3. Enter desired CW frequency.

1. Set [Sweep Type](#) to **CW Time** or **Power Sweep**.
2. Right click on the stimulus range area under grid box.
3. Click on **CW...**

Programming Commands

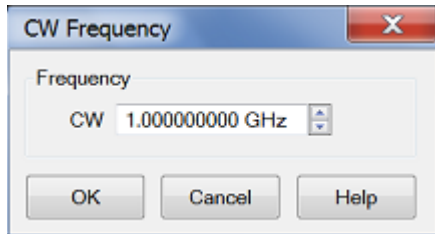

CW Frequency Dialog Box Help

CW - Type a value and the first letter of the suffix (k,m,or g) or use the up and down arrows to select any value within the range of the VNA.

Frequency Resolution

The resolution for setting frequency is 1 Hz.

Last modified:

29-Sep-2015 First release



Power Level

Power level is the power of the VNA source at the test ports.

- [How to make Power Settings](#)
- [Power Dialog](#)
- [Power and Attenuator Dialog](#)

See other 'Setup Measurements' topics

Power Settings

The test port output power is specified over frequency.

How to make Power settings

Using **Hardkey/SoftTab/Softkey**

1. Press **Power** > **Main** > **Power Level / Start Power / Stop Power** to enter desired power level.
2. Press **Power** > **Main** > **RF Power** to turn ON or OFF the RF power.
3. Press **Power** > **Leveling & Offsets** > click left side **Slope** small button to turn ON or OFF the slope (Green color means the slope is turns ON; Grey color means the slope is turns OFF).

Using a mouse

1. Right click on the X-axis label or stimulus range area under grid line.
2. Click **Power....** and then **Power:Channel N** dialog box appears.

Programming Commands

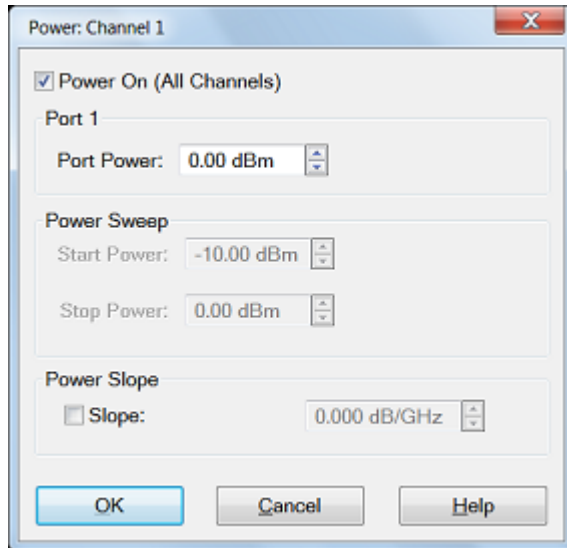

Power Dialog Box Help

Basic control of VNA source power for a specific port.

See [advanced control of source power and attenuation](#).

Power On (All Channels) - also same function as **RF Power**. Check to enable source power for all channels. Only turns power ON if channel power setting is ON or Auto. [See Advanced Power](#).

Port 'n' - Active source port for which power is being set.

Port Power - Sets the power level for the specified port.

- To accurately set the power level at any point after the test port, perform a [Source Power Calibration](#).
- See [specified power range of VNA model](#).

Power Sweep

Start/Stop Power - Set the start and stop power values of a power sweep.

- These settings are only available when [Sweep Type](#) is set to Power Sweep.
- Uncoupled power sweep power can be set from the [Advanced Power dialog](#).
- You can **Zoom** to easily change the start and stop power levels in a power sweep. [Learn how](#).
- [Learn more about Power Sweep](#).

Power Slope - Helps compensate for cable and test fixture power losses at increased frequency.

Slope - Select to set the power slope. Clear to set power slope OFF.

How to make Power and Attenuators settings

Using **Hardkey/SoftTab/Softkey**

1. Press **Power** > **Main** > **Power and Attenuators...** and then **Power and Attenuators** dialog box appears.

Details setting for Power and Attenuators

1. Press **Power** > **Main** > **RF Power** to turn ON or OFF the RF power.
2. Press **Power** > **Port Power** > **Select Port 1 / Port 2 / Port 3 / Port 4** to active the selected port.
3. Press **Power** > **Port Power** > **Power Level / Start Power / Stop Power** to enter desired power level for selected port.
4. Press **Power** > **Port Power** > **Source State** to choose the source state either Auto, On or Off.
5. Press **Power** > **Port Power** > **Coupling** to turn ON or OFF the Power Coupled.
6. Press **Power** > **Leveling & Offsets** > click left side **Slope** small button to turn ON or OFF the slope (Green color means the slope is turns ON; Grey color means the slope is turns OFF).

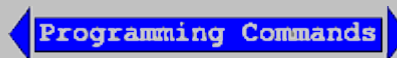

Power and Attenuators Dialog Box Help

Defines and controls the VNA source power and attenuation for the active channel.

External sources can be controlled from this dialog. [Learn more](#).

Power On (All Channels) - also same function as **RF Power**. Check to enable source power for all channels. Only turns power ON if channel power setting is ON or Auto.

Port Powers Coupled

- **Coupled** (checked) - The power levels are the same at each test port. Set power at any test port and all test ports change to the same power level.
- **Uncoupled** (cleared) - The power levels are set independently for each test port. Uncouple power, for example, if you want to measure the gain and reverse-isolation of a high-gain amplifier. The power required for the input port of the amplifier is much lower than the power required for the output port. A power sweep can also be performed with uncoupled power.

Name - Lists the VNA test ports.

State

- **Auto** - Source power is turned ON at the specified test port when required by the measurement. This is the most common (default) setting. See also [Power ON and OFF during Save/Recall, User Preset and Preset](#).
- **ON** - Source power is ALWAYS ON, regardless of measurements that are in process. Use this setting to supply source power to a DUT port that always requires power, such as an LO port. This could turn OFF power at another test port.
- **OFF** - Source power is never ON, regardless of the measurement requirements. Use this setting to prevent damage to a sensitive DUT test port.

Port Power - Sets the power level at the output of the source.

- To accurately set the power level at any point after the test port, perform a [Source Power](#)

Calibration.

- See [specified power range of VNA model](#).
- See [ECal Module Compression Level](#).

Start/Stop Power - Available ONLY when sweep type is set to Power Sweep. Set the start and stop power values of a power sweep. Learn more about [Power Sweep](#).

- You can specify whether to maintain source power at either the start power or stop power level at the end of a power sweep. Learn more about [Power Level](#).
- A power sweep can be performed with [uncoupled power](#). Different power ranges can be swept in the forward and reverse directions.

Leveling Mode

- **Internal** ALC leveling.

Channel Power Slope - Helps compensate for cable and test fixture power losses at increased frequency. With power slope enabled, the port output power increases (enter positive value) or decreases (enter negative value) as the sweep frequency increases.

Slope - Select to set the power slope. Clear to set power slope OFF.

Power slope is computed and applied from 0 GHz – not from the measurement start frequency. For example, with the following measurement settings:

- Start/Stop Freq: 1 GHz to 2 GHz
- Power level: 0 dBm
- Slope: 1 dB/GHz

The power into the DUT from 1 GHz to 2 GHz is 1 dBm sloping to 2 dBm.

Offset and Limits - Launches the [Power Offset and Limits](#) dialog.

Source Unleveled

When the power level that is required at a test port is **higher** than the VNA can supply, a Source Unleveled [error message](#) appears on the screen and the letters LVL appear on the [status bar](#)

To resolve an unleveled condition, change either the Test Port Power . If an Unleveled condition exists within the specified power range, [contact Technical Support](#). To set report source unleveled events as errors, please refer enable the preferences dialog.

Important Note: The available power range can also be adjusted AUTOMATICALLY by a Source Power Calibration, Guided Power Cal, or Power Compensation. If you are NOT seeing the range that you expect, or the correct power level at your DUT, view the Power Offset column in the [Power Limits and Offsets dialog](#).

Last modified:

29-Sep-2015 First Release



Sweep Settings

A sweep is a series of consecutive data point measurements taken over a specified sequence of stimulus values. You can make the following sweep settings:

- Number of Points (Separate topic)
- [Sweep Type](#)
 - [Linear Frequency](#)
 - [Log Frequency](#)
 - [Power Sweep](#)
 - [CW Time](#)
 - [Segment Sweep](#)
- [Frequency Range](#): Start/Stop (Separate topic)
- [Power Sweep](#)
- [Segment Sweep](#)
 - [How to make segment sweep settings](#)
 - [Segment Table dialog](#)
- [X-Axis Point Spacing - Segment Sweep ONLY](#)
- [Arbitrary Segment Sweep](#)
- [Sweep Time](#)
- [Sweep Setup](#)
 - [Auto vs Stepped](#)
 - [Dwell Time and Sweep Delay](#)
 - [Standard](#)
- Shift LO (Separate topic)

See [Triggering](#) and other 'Setup Measurements' topics

Sweep Type

How to set Sweep Type

Using **Hardkey/SoftTab/Softkey**

1. Press **Sweep** > **Main** > **Sweep Type**.

Using a mouse

1. Right click on the [stimulus range](#) area under grid box.
2. Click **Sweep Setup...**
3. Select **Sweep Type** tab.
4. Click **Apply** to implement the setting changes.

Programming Commands

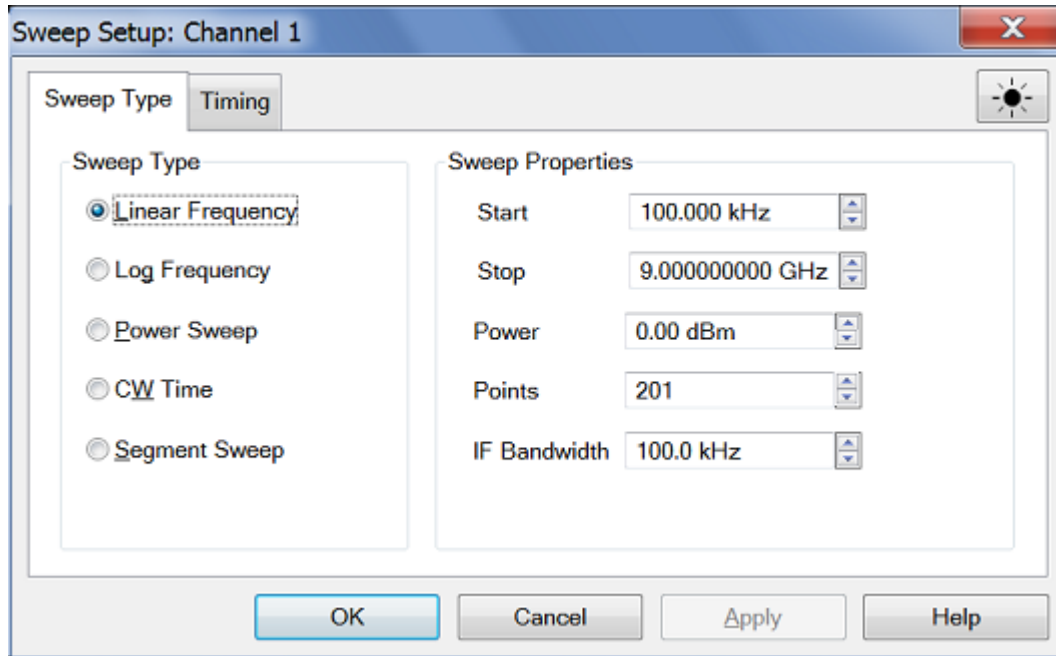

Sweep Type Dialog Box / Sweep > Main > Sweep Type Softtab Help

Note: Sweep Settings are not applied until either **OK** or **Apply** is pressed.

Channel - The active channel when Sweep Type was selected. Sweep settings will be applied to this channel.

Linear Frequency - Sets a linear frequency sweep that is displayed on a standard grid with ten equal horizontal divisions.

- **Start** - Sets the beginning value of the frequency sweep.
- **Stop** - Sets the end value of the frequency sweep.
- **Power** - Sets the power level for selective port.
- **Points** - Sets the number of data points that the VNA measures during a sweep.
- **IF Bandwidth** - Sets the IF (Receiver) bandwidth.

Log Frequency - The source is stepped in logarithmic increments and the data is displayed on a logarithmic X-axis. This is usually slower than a continuous sweep with the same number of points.

- **Start** - Sets the beginning value of the frequency sweep.
- **Stop** - Sets the end value of the frequency sweep.
- **Power** - Sets the power level for selective port.
- **Points** - Sets the number of data points that the VNA measures during a sweep.
- **IF Bandwidth** - Sets the IF (Receiver) bandwidth.

Power Sweep - Activates a power sweep at a single frequency that specify. Learn more about [power sweep](#)

- **Start Power** - Sets the beginning value of the power sweep.
- **Stop Power** - Sets the end value of the power sweep.
- **CW Freq** - Sets the single frequency where the VNA remains during the measurement sweep.
- **Points** - Sets the number of data points that the VNA measures during a sweep.
- **IF Bandwidth** - Sets the IF (Receiver) bandwidth.

CW Time - Sets the VNA to a single frequency and the data is displayed versus time. [Learn more.](#)

- **CW Freq** - Sets the frequency where the VNA remains during the measurement.F
- **Power** - Sets the power level for selective port.
- **Points** - Sets the number of data points that the VNA measures during a sweep.
- **IF Bandwidth** - Sets the IF (Receiver) bandwidth.

Segment Sweep - Sets the VNA to sweep through user-defined sweep segments. [Learn how to make these settings.](#)

OK - Applies setting changes and closes the dialog box.

Cancel - Closes the dialog. Setting changes that have been made do not apply and save, but it remain setting since the last Apply button is clicked.

Apply - Applies setting changes and leaves the dialog box open to make more setting changes.

Help - Display the **Sweep Type** dialog box help.

Power Sweep

A power sweep either increases or decreases source power in discrete steps. Power sweep is used to characterize power-sensitive circuits, with measurements such as gain compression.

In the **Sweep Type** dialog, specify Start Power, Stop Power, CW Frequency, Points and IF Bandwidth.

The remaining power settings apply in power sweep mode:

- Test Port Power setting is not available.
- Port Power can be coupled or uncoupled.
- Power Slope (dB/GHz) is ignored (output frequency is CW).
- Press **Sweep** > **Main** > **Number of Points** to change the step size of the power sweep.

Notes:

- Power Sweep has been optimized for speed. For highest measurement accuracy during a power sweep, it may be necessary to increase the [Dwell Time](#) to allow the source more time to settle.

Segment Sweep

Segment Sweep activates a sweep which consists of frequency sub-sweeps, called segments. For each segment can define independent power levels, IF bandwidth, IF bandwidth per port, sweep time, delay, sweep mode and Shift LO.

Once a measurement calibration is performed on the entire sweep or across all segments, measurements can be calibrated for one or more segments.

In segment sweep type, the analyzer does the following:

- Sorts all the defined segments in order of increasing frequency.
- Measures each point.
- Displays a single trace that is a composite of all data taken.

Restrictions for segment sweep:

- The frequency range of a segment is not allowed to overlap the frequency range of any other segment.
- The number of segments is limited only by the combined number of data points for all segments in a sweep.

How to make segment sweep settings

Using **Hardkey/SoftTab/Softkey**

1. Press **Sweep** > **Segment Table**.

Using a mouse

1. Right click on the X-axis label or stimulus display area under grid line.
2. Click **Sweep Setup...** > select **Segment Sweep** under sweep type.
3. Click **Segment Table....**

◀ **Programming Commands** ▶

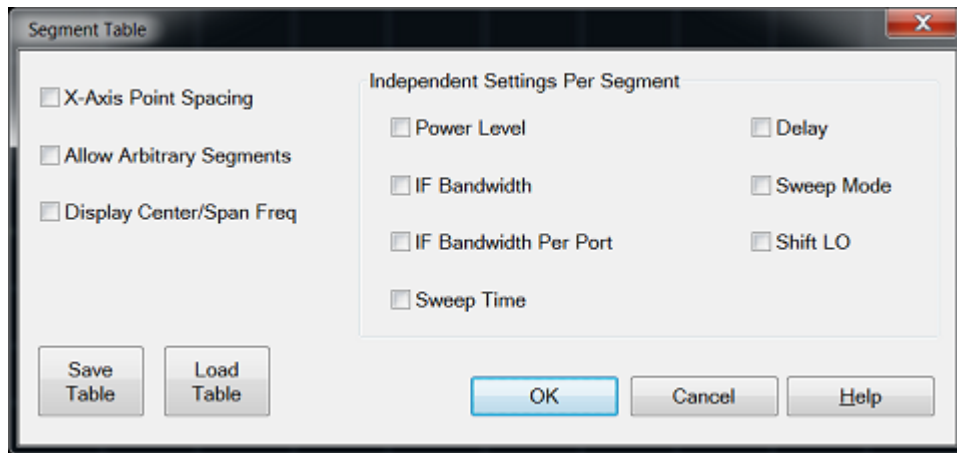

Segment Table Dialog Box Help / **Sweep** > **Segment Table** Softtab Help

Add Segment - adds a sweep segment at last segment.

Insert Segment - adds a sweep segment before the selected segment. You can also click the "down" arrow on your keyboard to quickly add many segments.

Delete Segment - removes the selected segment.

Delete All Segments - removes all segments.

Note: At least ONE segment must be ON or [Sweep Type](#) is automatically set to **Linear**.

Segment Table dialog box

X-Axis Point Spacing - Check to scale the X-axis to include only the segments. [Learn more](#).

Allow Arbitrary Segments - Check to allow arbitrary frequencies (overlapped or reverse sweep). [Learn more](#).

Display Center/Span Freq - Check to display the center/span frequency.

Independent Setting Per Segment

Power Level - Sets the [Power level](#) for the segment. Also, the test port power can UNCOUPLE. See [Power Coupling](#).

IF Bandwidth - Sets the [IF Bandwidth](#) for the segment.

IF Bandwidth Per Port - Sets the different bandwidth with different port for the segment.

Sweep Time - Sets the [Sweep time](#) for the segment.

Delay - Sets the time to wait just before acquisition begins for each segment.

Dwell - Specifies the time the source stays at each measurement point before the analyzer takes the data.

Sweep Mode - Sets the sweep mode to auto or stepped.

Shift LO - Sets the state of Shift LO. [Learn More](#).

Save Table - Saves the setting changes in segment table.

Load Table - Apply the setting changes in segment table.

To Modify an Existing Segment

To make the following menu settings available, the segment table must show first. (Press **Sweep > Segment Table**)

	State	Start	Stop	Points	IFBW	Time	Power	Delay	Sweep Mode	LO Offset
1	On	1.000000 GHz	5.000000 GHz	21	1.0 kHz	0.520 sec	0.00 dBm	1.000 sec	Auto	On
2	Off ▾	5.000000 GHz	6.000000 GHz	1001	1.0 kHz	1.951 sec	-10.00 dBm	0.500 sec	Stepped	Off

The above graphic shows the Segment table with all independent settings selected, including source power uncoupled (two power settings).

State - Click the box on the segment to be modified. Then, use the up/down arrow to turn the segment ON or OFF.

Start - Sets start frequency for the segment. Click the box and type a value and the first letter of a suffix (**KHz**, **Mhz**, **GHz**). Or double-click the box to select a value.

Stop - Sets stop frequency for the segment. Click the box and type a value and the first letter of a suffix (**KHz**, **Mhz**, **GHz**). Or double-click the box to select a value.

Note: The segment table truncates the frequency resolution. To verify the frequency resolution that you input, create a marker at the start or stop frequency settings.

Points - Sets number of data points for this segment. Insert a value or double-click the box to select a value.

To set **Power Level, IF Bandwidth/IF Bandwidth Per Port, Sweep Time, Delay, Sweep Mode** and **Shift LO** independently for each segment:

1. Press **Sweep > Main > Sweep Type > Segment Sweep**.
2. Click on **Segment Table > Segment Table...**
3. Click the box and type a value or double-click the box and select a value.

Note: If the following are NOT set, the entire sweep uses the channel IFBW, Power, and Time settings.

X-Axis Point Spacing - Segment Sweep ONLY

This feature affects how a segment trace is drawn on the screen.

How to enable X-axis Point Spacing

Using **Hardkey/SoftTab/Softkey**

1. Press **Sweep** > **Segment Table** > **Segment Table...**
2. Tick on **X-Axis Point Spacing**.

Using a mouse

1. Right click on the X-axis label or stimulus range area under grid line.
2. Click **Sweep Setup...** > select **Segment Sweep** under sweep type.
3. Click **Segment Table...**
4. Tick on **X-Axis Point Spacing**.

Programming Commands

- **Without X-axis point spacing**, a multi-segment sweep trace can sometimes result in squeezing many measurement points into a narrow portion of the X-axis.
- **With X-axis point spacing**, the X-axis position of each point is chosen so that all measurement points are evenly spaced along the x-axis.

For example, given the following two segments:

	State	Start	Stop	Points
1	On	870.000000 MHz	970.000000 MHz	6
2	On	970.000000 MHz	1.070000 GHz	11

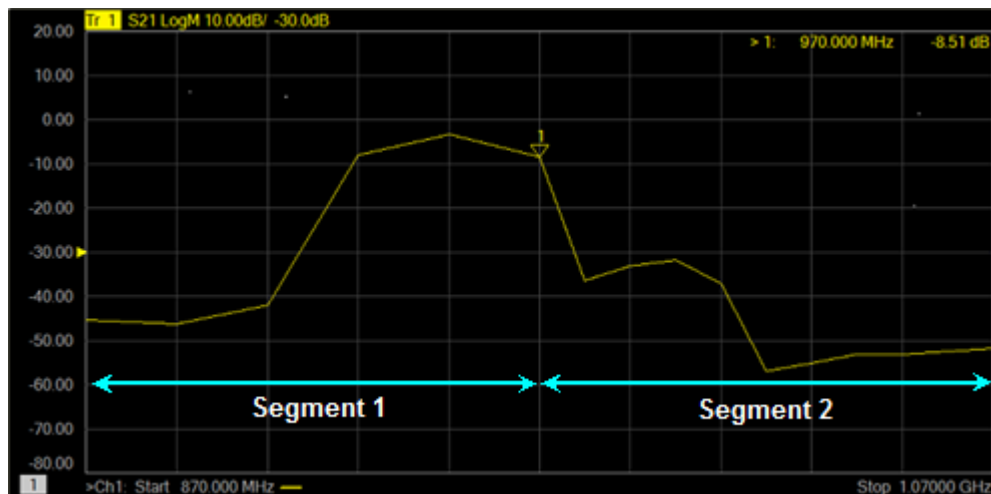

Without X-Axis Point Spacing

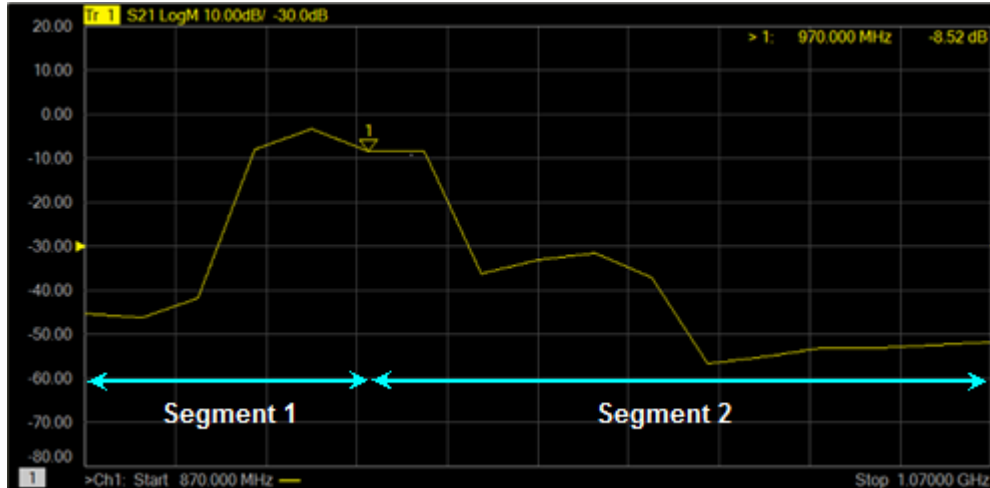

With X-Axis Point Spacing

Arbitrary Segment Sweep

This feature allows arbitrary frequencies to be entered into the segment sweep table. With this capability, segments can have:

- Overlapping frequencies.
- The stop frequency less than the start frequency (reverse sweep).

However, there are several limitation:

- Sweep mode: Stepped only.
- Sweep time: When reverse sweep is performed, the sweep time and the wait time before the measurement point becomes longer.

How to enable Arbitrary Segment Sweep

Using **Hardkey/SoftTab/Softkey**

1. Press **Sweep** > **Segment Table** > **Segment Table...**
2. Tick on **Allow Arbitrary Segment Sweep**.

Using a mouse

1. Right click on the X-axis label or stimulus range area under grid line.
2. Click **Sweep Setup...** > select **Segment Sweep** under sweep type.
3. Click **Segment Table...**
4. Tick on **Allow Arbitrary Segment Sweep**.

Programming Commands

Notes:

- Unusual results may occur when using arbitrary sweep segments with markers, display, limit lines, formatting and some calibration features.
- When the segment table has both forward and reverse frequency sweep, the correction interpolation may not work properly. Use the same segment table setting at both, correction and measurement. (Make a measurement at the condition where "Cor" is displayed.)
- When the number of data of segment table exceeds its limitation, the error occurs. In this case, reduce the measurement data size (i.e. NOP, number of channels).

Sweep Time

The VNA automatically maintains the fastest sweep time possible with the selected measurement settings. However, you can increase the sweep time to perform a slower sweep.

How to set Sweep Time

Using **Hardkey/SoftTab/Softkey**

1. Press **Sweep** > **Sweep Timing** > **Sweep Time** to change Manual.
2. Input the desired sweep time.

Using a mouse

1. Right click on the X-axis label or stimulus range area under grid line.
2. Click on **Sweep Setup...**
3. Select **Timing** tab.
4. Turn off the check box of **Auto Sweep Time**.
5. Input the desired sweep time.

◀ Programming Commands ▶

Sweep > Sweep Timing Softtab Help

Sweep Time - Specifies the time the VNA takes to acquire data for a sweep. The maximum sweep time of the VNA is depends on various settings (ex, IFBW, Dwell Time, Number of points, etc). Learn about [other settings that affect sweep speed](#).

Sweep Setup

How to make Sweep Setup settings

Using **Hardkey/SoftTab/Softkey**

1. Press **Sweep** > **Sweep Timing**.

Using a mouse

1. Right click on the X-axis label or stimulus range area under grid line.
2. Click on **Sweep Setup...**
3. Select **Timing** tab.

◀ Programming Commands ▶

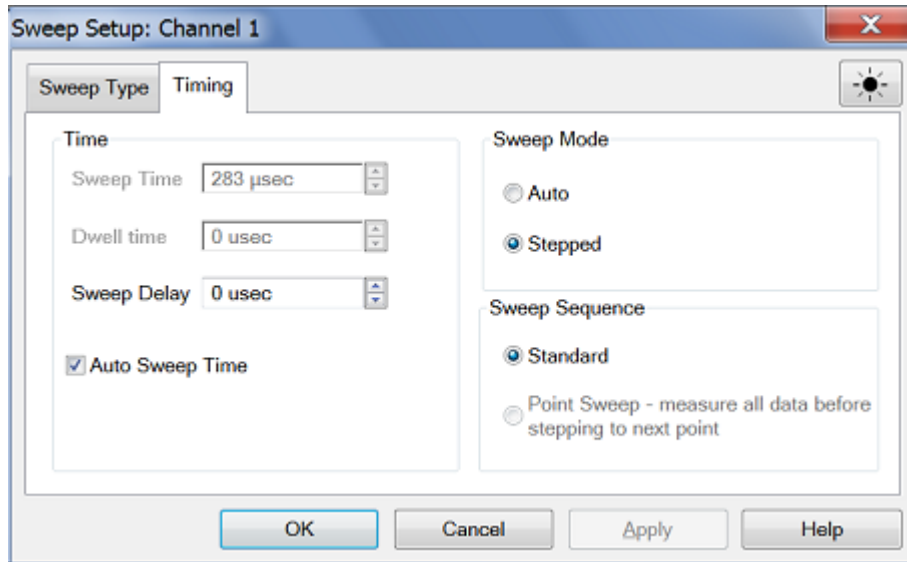

Sweep Setup Dialog Box / **Sweep** > **Sweep Timing** Softtab Help

Time

Sweep Time - same as [Sweep Time Softtab Help](#).

Dwell Time - Specifies the time the source stays at each measurement point before the analyzer takes the data. Only applies to stepped sweep. The maximum dwell time is 20 seconds. See also [Electrically Long Devices](#).

Sweep Delay - Specifies the time to wait just before acquisition begins for each sweep. This delay is in addition to Dwell Time (per point) and [External Trigger delay](#) if enabled.

Auto Sweep Time - Automatic adjust the sweep time and dwell time. When "Auto Sweep Time" is checked, the sweep time and dwell time will disable to edit.

Sweep Mode

Auto Sweep - When clicked on Auto Sweep Mode, the VNA choose automatically the fastest sweep mode either Swept (Analog Sweep) or Stepped. (The sweep time for S Sweep is faster than Stepped Sweep.) The mode can change from sweep to sweep. There is **NO way** to determine whether the VNA is in Analog or Stepped Sweep. If you want to be sure what the current sweep mode is, then switch it to Stepped.

Stepped Sweep - When clicked on Stepped Sweep Mode, the VNA source is tuned, then waits the specified Dwell time, then takes response data, then tunes the source to the next frequency point. This is slower than Analog Sweep, but is more accurate when testing electrically-long devices.

Stepped sweep is automatically selected for a number of reasons. Here are some of the reasons:

- [IF Bandwidth](#) is at, or below, 9 kHz.
- [Source Power Correction](#) is ON unless doing CW measurement.
- When step mode is a faster way to take the data.
- For all FOM measurements.

Sweep Sequence

Standard Sweep - When checked, the VNA sweeps all data points for each source port in turn. For a 2-port VNA, this means that all data points are swept in the forward direction, then all data points are swept in the reverse direction. Even when NO reverse parameters are displayed (S22 or S12), reverse measurements are necessary when a full 2-port calibration is correcting the channel. This is the default behavior. [Learn more.](#)

Last modified:

29-Sep-2015 First Release



Trigger

A trigger is a signal that causes the VNA to make a measurement sweep. The VNA offers great flexibility in configuring the trigger function.

View the interactive [Trigger Model](#) animation to see how triggering works in the VNA.

- [How to Set Trigger](#)
- [Source](#)
- [Scope](#)
- [Channel Settings](#)
- [Restart](#)
- [External and Auxiliary Triggering](#) (separate topic)

See other 'Setup Measurements' topics

Trigger Setting

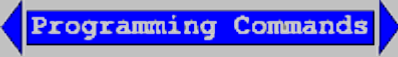
How to set Triggering	
<p>Using Hardkey/SoftTab/Softkey</p> <ol style="list-style-type: none"> 1. Press Trigger > Main > Trigger... 	<p>Using a mouse</p> <ol style="list-style-type: none"> 1. Right click on the Trig or Meas icons on the status bar. 2. Select on Trigger...
	

Note: The **Continuous**, **Single**, and **Hold** settings apply ONLY to the active channel. These settings are available from the Trigger menu, Active Entry keys, and softkeys

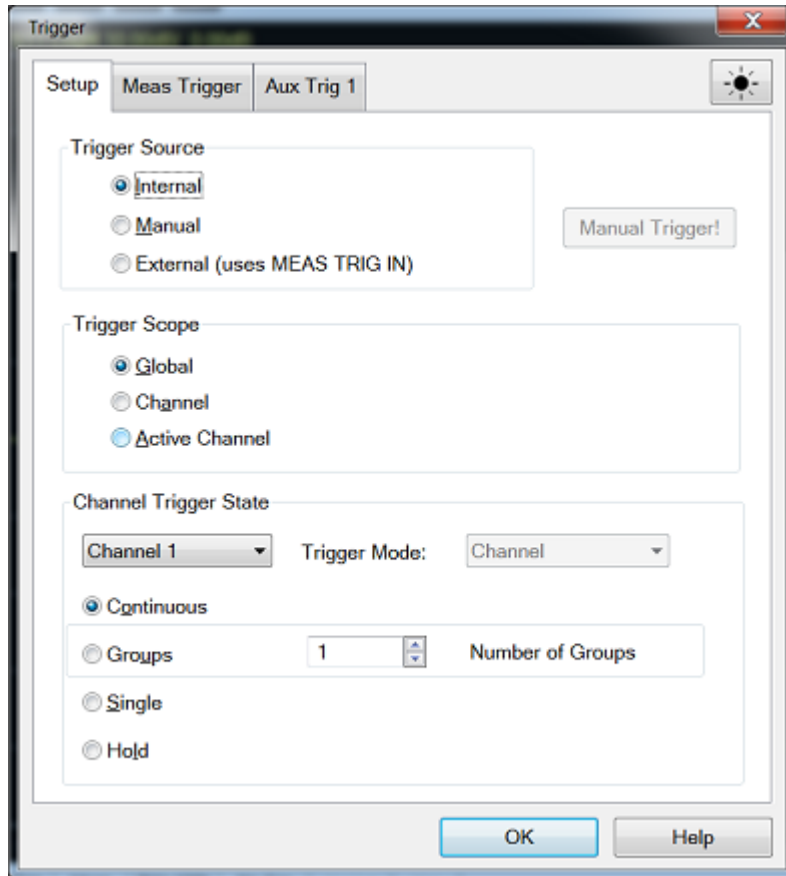

Trigger Setup Dialog Box Help

View the interactive [Trigger Model](#) animation to see how triggering works in the VNA.

Trigger Source

These settings determine **where** the trigger signals originate for all existing channels. A valid trigger signal can be generated only when the VNA is not sweeping.

Internal - Continuous trigger signals are sent by the VNA as soon as the previous measurement is complete.

Manual - One trigger signal is sent when invoked by the Trigger button, the active toolbar or a programming command.

External (uses MEAS TRIG IN) - Trigger signals sent out or received from various connectors on the rear panel. [Learn more about External and AUX Triggering.](#)

Manual Trigger! - Manually sends one trigger signal to the VNA. Available ONLY when Manual trigger is selected.

Trigger Scope

These settings determine **what** is triggered.

Global - Triggers sent to all triggerable channels. One trigger will sweep all channels that are triggerable. [Default setting]

Channel - A trigger is sent to the current channel, but the channel is incremented to the next triggerable channel after the current channel is complete.

Active Channel - Trigger are sent only to the active channel. The active channel does not change.

Channel Trigger State

These settings determine **how many** trigger signals the channel will accept.

Continuous - The channel accepts an infinite number of trigger signals.

Groups - The channel accepts only the number of trigger signals that is specified in the Number of Groups text box, then goes into Hold. Before selecting groups you must first increment the Number of Groups text box to greater than one.

Number of Groups - Specify the number of triggers the channel accepts before going into Hold. If in Point Sweep, an entire sweep is considered one group.

First increment to desired number, then select 'Groups'.

Single - The channel accepts ONE trigger signal, then goes into Hold.

Another way to trigger a single measurement is to set [Trigger Source](#) to Manual, then send a **Manual trigger**. However, ALL channels are single triggered.

Hold - The channel accepts NO trigger signals.

Trigger Mode

These settings determine what EACH signal will trigger.

Sweep and **Point** modes are available ONLY when both [Trigger Source](#) = MANUAL or EXTERNAL AND [Trigger Scope](#) = CHANNEL.

- **Channel** - Each trigger signal causes **ALL traces** in that channel to be swept in the order specified below.
- **Point** - Each Manual or External trigger signal causes one data point to be measured. Subsequent triggers go to the same trace until it is complete, then other traces in the same channel are swept in the order specified below. When in Groups or Single trigger, the count is decremented by one after ALL data points on ALL traces in the channel are measured. See Also, the (point) [Sweep Indicator](#) and [SCPI Triggering example](#) for use with External.
- **Trace** - Available ONLY when [Point Sweep](#) is selected. Each trigger signal causes two identical measurements to be triggered separately - one trigger signal is required for each measurement. Other trigger mode settings cause two identical parameters to be measured simultaneously. Trace triggering is NOT permitted when a channel is using a 2 port (or more) S-Parameter calibration.
- **Sweep** - Each Manual or External trigger signal causes **ALL traces that share a source port** to be swept in the order specified below. When in Groups or Single trigger, the count is decremented by one after ALL traces in ALL directions are swept.

When multipoint correction is ON, which requires sweeps in more than one direction, traces on the screen will not update until all of the relevant directions have been swept. For example, with all four 2-port S-Parameters displayed:

- When Full 2-port correction is ON, trigger 1 causes NO traces to update; trigger 2 causes ALL S-Parameters to update. [Learn more about sweeps with correction ON.](#)
- When correction is OFF, trigger 1 causes S11 and S21 to update; trigger 2 causes S22 and S12 to update.

Trace Sweep Order

For ALL Trigger Modes, trigger signals continue in the same channel until all traces in that channel are complete. Triggering then continues to the next channel that is not in HOLD.

Traces within each channel are always swept in the following order:

- Traces are swept sequentially in source-port order. For example, in a channel with all four 2-port S-parameters, first the source port 1 traces (S11 and S21) are swept simultaneously. Then the source port 2 traces (S22 and S12) are swept simultaneously.

Restart - (Available only from the Trigger menu) Channels in Hold are set to single trigger (the channel accepts a single trigger signal). All other settings are unaffected, including decrementing trigger Groups.

See Also

- [External and AUX Triggering.](#)
- Interactive [Trigger Model](#) animation

Last modified:

29-Sep-2015 First Release



External and Auxiliary Triggering

External and Auxiliary triggering are both used to synchronize the triggering of the VNA with other equipment.

Note: When an External Source is configured as an External Device, the VNA automatically controls all trigger settings. Do NOT make additional trigger settings. [Learn more.](#)

- [Overview](#)
- How to make Trigger Settings:
 - [Meas Trig \(IN\)](#)
 - [Auxiliary Triggering](#)

See Also

- [Synchronizing an External Source](#)
 - [Trigger](#)
-

Overview

Ready Signals versus Trigger Signals

A 'Ready for Trigger' signal is different from a Trigger signal. The ready signal indicates that the instrument sending the signal is ready for measurement. The instrument receiving the ready signal would then send a trigger signal, indicating that the measurement will be, or has been, made. Usually the slower instrument sends the trigger signal.

Learn more about each type of triggering signal:

- [Meas Trig IN](#) - These signals are easy to use and limited in ability to configure.
- [AUX TRIG OUT](#) - The connector and signal are highly configurable. Use them to synchronize with any number of devices and equipment.

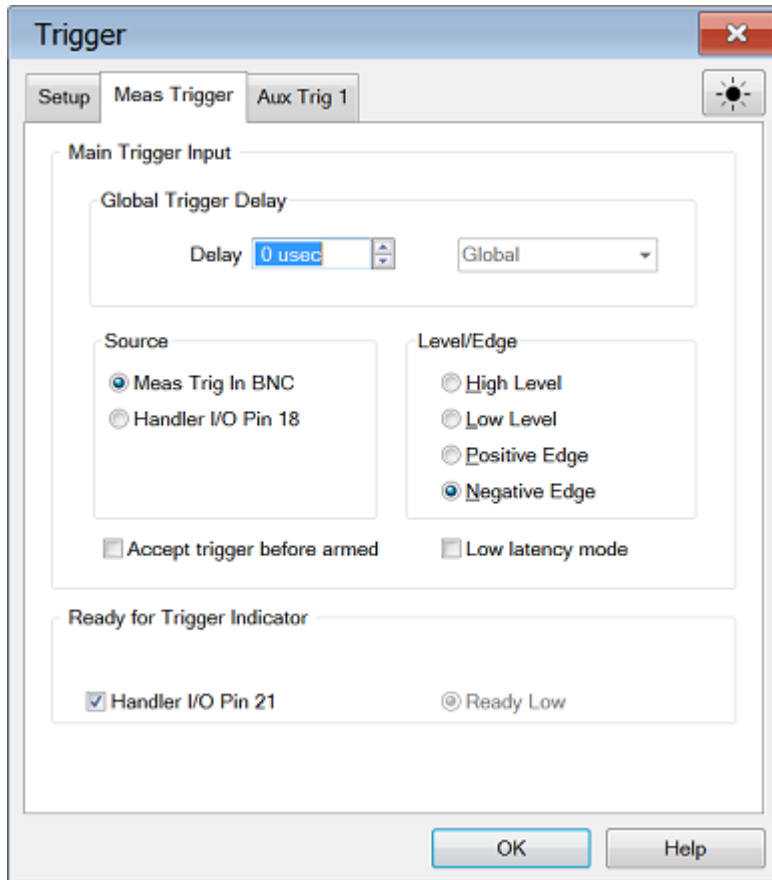

Meas (External) Trigger Dialog Box Help

[See how to access the Trigger Dialog](#)

Meas Trig IN

The trigger input connectors are located on the VNA rear-panel.

These signals can be used when the VNA is communicating with a slow mechanical device. A material handler is very mechanical and takes a relatively long time to load and discharge parts. Here is how these signals work together to communicate:

1. The VNA sends a 'Ready' signal when it is ready to make a measurement.
2. The external device sends a trigger signal to the VNA when it is ready for a measurement.
3. Additional signals are available on the VNA Handler I/O to indicate that the VNA sweep has ended, and that the handler can setup for the next measurement.

Dialog Settings

To cause the VNA to respond to Meas Trig IN or Handler I/O signals, select **External** on the [Trigger Setup tab, Source](#) setting.

Also on the Trigger Setup tab, Scope setting, choose whether one external trigger signal will apply to ALL channels (Global) or one trigger signal per Channel. The following settings apply accordingly.

Main Trigger Input

Global / Channel Trigger Delay - After an external trigger is received, the start of the sweep is held off for this specified amount of time plus any inherent latency.

- When [Trigger Scope](#) = Channel, the delay value is applied to the specified channel.

- When Trigger Scope = Global, the same delay value is applied to ALL channels.

Source The VNA accepts Trigger IN signals through the following connectors:

- Meas Trig IN BNC: Trigger input on the rear panel
- Handler I/O Pin 18

Polarity

High Level - The VNA is triggered when it is armed (ready for trigger) and the TTL signal at the select input is HIGH.

Low Level - The VNA is triggered when it is armed (ready for trigger) and the TTL signal at the select input is LOW.

Positive Edge - After the VNA arms, it will trigger on the next positive edge. If [Accept Trigger Before Armed](#) is set, VNA will trigger as soon as it arms if a positive edge was received since the last data was taken.

Negative Edge - After the VNA arms, it will trigger on the next negative edge. If [Accept Trigger Before Armed](#) is set, VNA will trigger as soon as it arms if a negative edge was received since the last data was taken.

Accept Trigger Before Armed - When checked, as the VNA becomes armed (ready to be triggered), the VNA will immediately trigger if any triggers were received since the last taking of data. The VNA remembers only one trigger signal. All others are ignored.

- When this checkbox is cleared, any trigger signal received before VNA is armed is ignored.
- This feature is only available when positive or negative EDGE triggering is selected.
- Configure this setting remotely using [CONTROL:SIGNAl](#) (SCPI)ExternalTriggerConnectionBehavior.

Low latency mode: - When checked, variations in delay time between the reception of a trigger and the start of a one-point measurement are decreased for point trigger measurement. However, the /READY FOR TRIGGER does not output for each points at this mode.

- Point Trigger: ON, Low Latency: ON

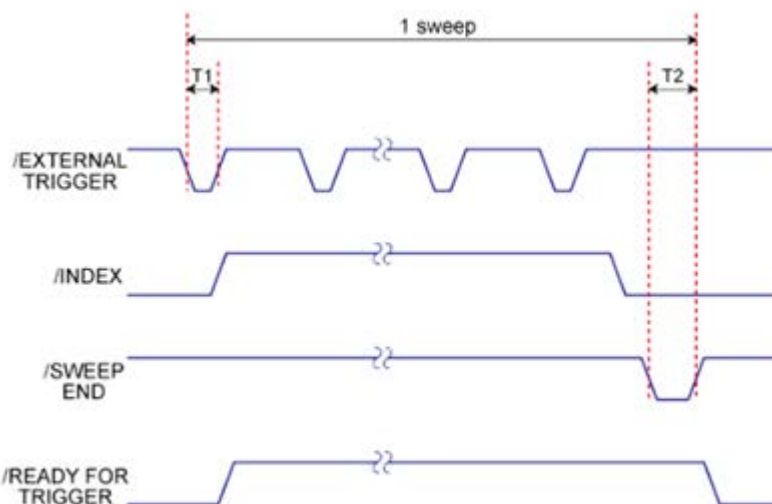

- Point Trigger: ON, Low Latency: OFF

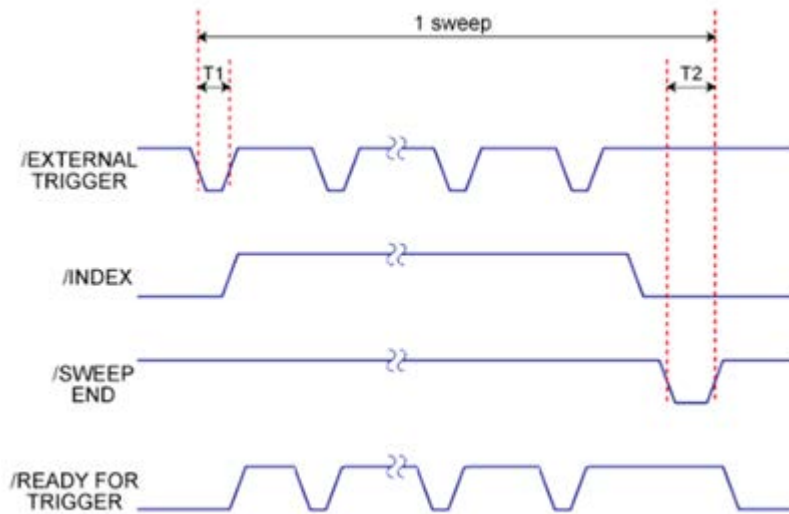

Ready for Trigger Indicator (OUT)

On the VNA, when External is selected on the Trigger Setup tab, then both Meas Trig IN and Meas Trig Ready (OUT) are enabled.

Choose a connector to send the VNA Ready OUT signal:

- Handler I/O p21

Choose Polarity of the 'Ready OUT' signal.

- **Ready Low** - TTL Low indicates the VNA is ready for trigger (Ready High is not available on the E5080A.)

See Also

- [Learn how to External Trigger during Calibration](#)

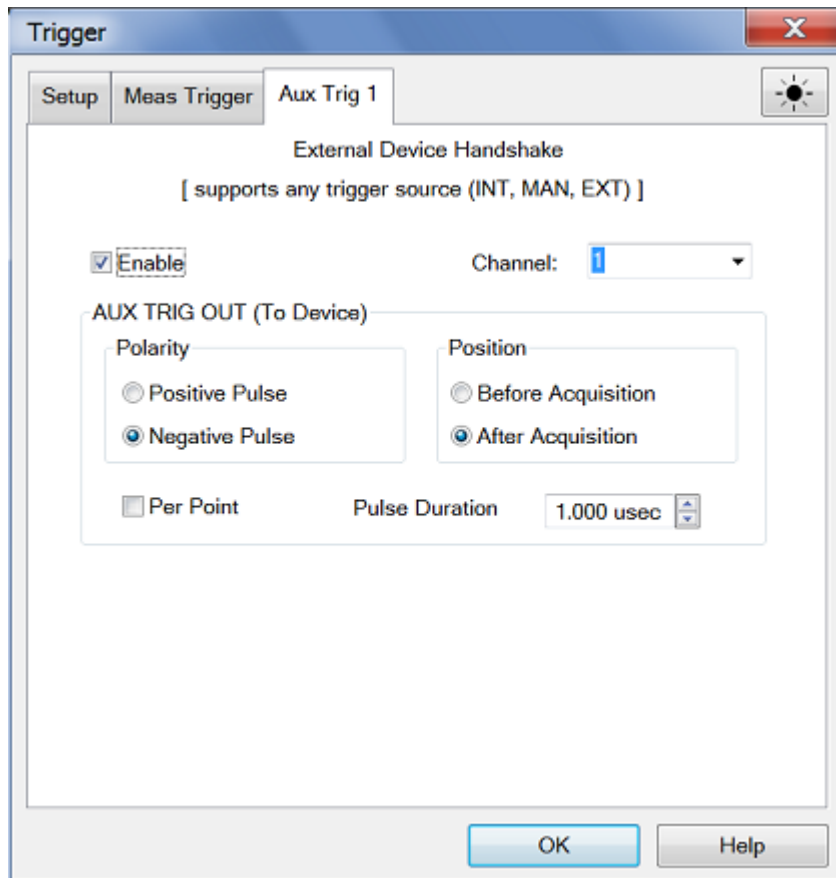

Aux Trig 1 Dialog Box Help

[See how to access the Trigger Dialog](#)

Note: When an External Source is configured as an External Device, the VNA automatically controls all trigger settings. Do NOT make additional trigger settings. [Learn more.](#)

AUX TRIG OUT

The AUX TRIG connector is located on the VNA rear-panel.

1. the VNA begins the measurement when it receives a Trigger signal from the specified [Trigger Source](#):
 - **Internal** - Measurement begins immediately.
 - **Manual** - Measurement begins when the VNA Trigger button is pressed.
 - **External** - Measurement begins when [Meas Trig In](#) signal is received from an external device. This must be configured independently.
3. The Aux Trig OUT signal can be configured to be sent either just BEFORE the measurement is made or AFTER the measurement is complete. When communicating ONLY with an external source, the Aux Trig OUT signal should be sent AFTER the measurement is complete to indicate that the external source can setup for the next measurement.

Dialog Settings

Enable - Check to use the Aux connector to output signals to an external device.

Channel: This setting is controlled by a VNA Preference setting.

- **Global** - ALL Aux Trig settings apply to ALL channels. The Per Point setting (see below) is

made on the [Trigger Setup tab](#) which also applies to ALL channels.

- **Channel** - ALL Aux Trig settings apply to the specified channel. Each channel can be configured independently.

AUX TRIG OUT (To Device)

The following settings control the properties of the signals sent out the rear panel AUX TRIG OUT connector:

Polarity

Positive Pulse - Outgoing pulse is positive.

Negative Pulse - Outgoing pulse is negative.

Position

Before Acquisition - Pulse is sent immediately **before** data acquisition begins.

After Acquisition - Pulse is sent immediately **after** data acquisition is complete.

Per Point - Check to cause a trigger output to be sent for each data point. Clear to send a trigger output for each sweep.

When the Aux Trig - "Global" VNA Preference is selected, then the Point setting is made on the [Trigger Setup tab](#). It then applies to ALL channels. When more than one channel is present, the channel setting that was made last is used.

Pulse Duration - Specifies the duration of the positive or negative output trigger pulse.

See Also

- See how to use these connectors to synchronize with External Sources.

Note: Guided and Unguided Calibration CAN be performed in External Trigger mode. With this optional behavior, while Trigger Source is set to External, trigger signals must be sent for Calibration sweeps. This behavior does not apply to FCA calibrations.

The following dialog box appears on the VNA screen while the VNA is waiting for an External trigger signal.

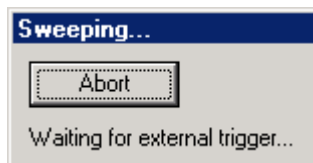

Click **Abort** to cancel the wait for a trigger signal.

Last Modified:

29-Sep-2015 First Release



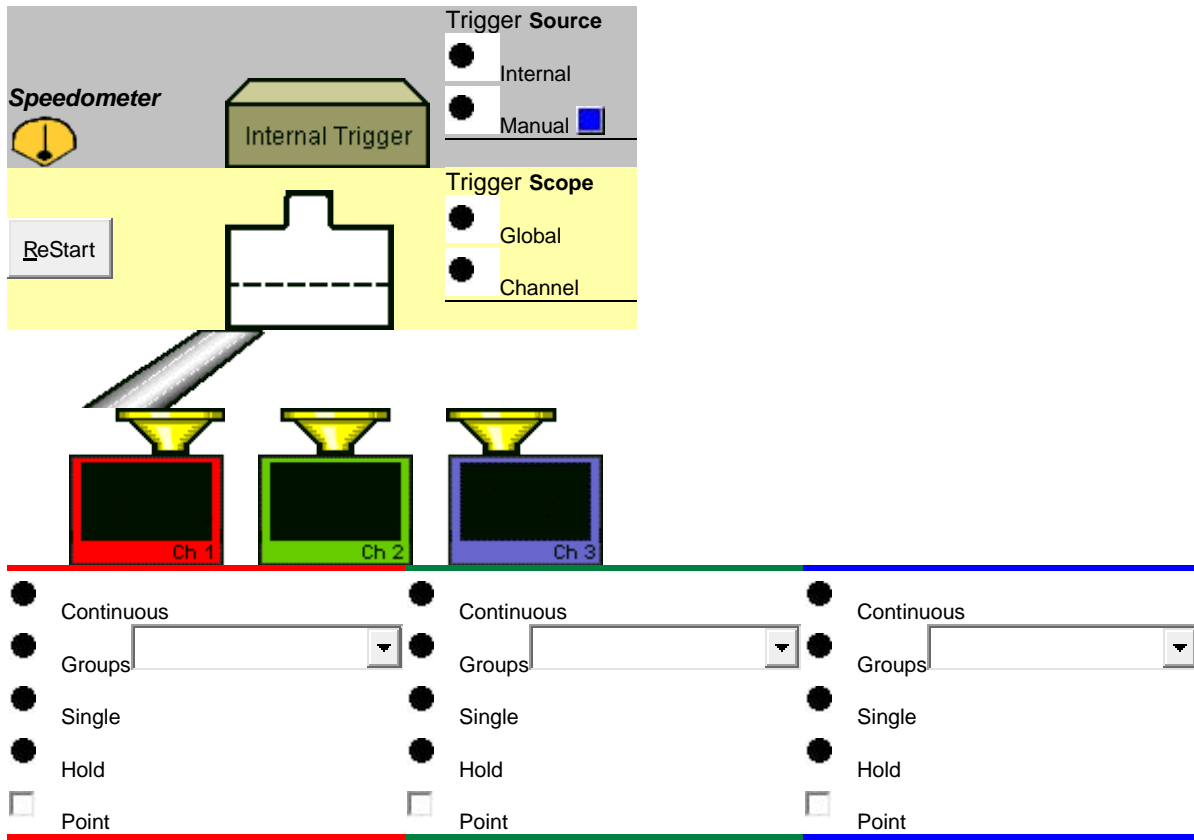

[About the trigger model](#)

Read [Text description](#) of triggering behaviors.

This model does not include the new [Sweep trigger mode](#).

Data Format

A data format is the way the VNA presents measurement data graphically. Pick a data format appropriate to the information you want to learn about the test device.

- [Display Format](#)
- [Rectangular \(Cartesian\) Display Formats](#)
- [Polar](#)
- [Smith Chart](#)

See other 'Setup Measurements' topics

Display Format

How to set the Display Format

Using **Hardkey/SoftTab/Softkey**

1. Press **Format** > **Format 1** or **Format 2**.

Using a mouse

1. Right-click on the trace status area above the grid box.
2. Click **Format**.
3. Select the desired format.

[Programming Commands](#)

Format > **Format 1, Format 2** SoftTab help

- [Log Mag](#)
- [Phase / Unwrapped Phase](#)
- [Group Delay](#)
- [Smith / Inverse Smith Chart](#)
- [Polar](#)
- [Linear Mag](#)
- [SWR](#)
- [Real](#)
- [Imaginary](#)

Rectangular Display Formats

Seven of the nine available data formats use a rectangular display to present measurement data. This display is also known as Cartesian, X/Y, or rectilinear. The rectangular display is especially useful for clearly displaying frequency response information of your test device.

- Stimulus data (frequency, power, or time) appears on the X-axis, scaled linearly
- Measured data appears on the Y-Axis.

Log Mag (Logarithmic Magnitude) Format

- Displays Magnitude (no phase)
- Y-axis: dB
- Typical measurements:
 - Return Loss
 - Insertion Loss or Gain

Phase Format

Measures the phase of a signal relative to the calibration reference plane with a range of +/- 180 degrees.

- Displays Phase (no magnitude)
- Y-axis: Phase (degrees)
- The trace 'wraps' every 180 degrees for easier scaling.
- Typical Measurements:
 - [Deviation from Linear Phase](#)

Unwrapped Phase

- Same as Phase, but without 180 degree wrapping.

Note: Phase is unwrapped by comparing the phase from one data point to the next. If the phase difference between two points is greater than 180 degrees, or if the phase of the first data point is greater than 180 degrees from DC, then the phase measurement is probably NOT accurate.

Group Delay Format

- Displays signal transmission (propagation) time through a device
- Y-axis: Time (seconds)
- Typical Measurements:
 - Group Delay

See Also:

[Group Delay \(Measurement\)](#)

[Comparing the VNA Delay Functions.](#)

[Phase Measurement Accuracy](#)

Linear Magnitude Format

- Displays positive values only
- Y-axis: Unitless (**U**) for ratioed measurements
Watts (**W**) for unratioed measurements.
- Typical Measurements:
 - reflection and transmission coefficients (magnitude)
 - time domain transfer

SWR Format

- Displays reflection measurement data calculated from the formula $(1+\rho)/(1-\rho)$ where ρ is reflection coefficient.
- Valid only for reflection measurements.

- Y axis: Unitless
- Typical Measurements:
 - SWR

Real Format

- Displays only the real (resistive) portion of the measured complex data.
- Can show both positive and negative values.
- Y axis: Unitless
- Typical Measurements:
 - time domain
 - auxiliary input voltage signal for service purposes

Imaginary Format

- Displays only the imaginary (reactive) portion of the measured data.
- Y - axis: Unitless
- Typical Measurements:
 - impedance for designing matching network

Polar Format

Polar format is used to view the magnitude and **phase** of the reflection coefficient (Γ) from your S_{11} or S_{22} measurement.

You can use Markers to display the following:

- Linear magnitude (in units) or log magnitude (in dB)
- Phase (in degrees)

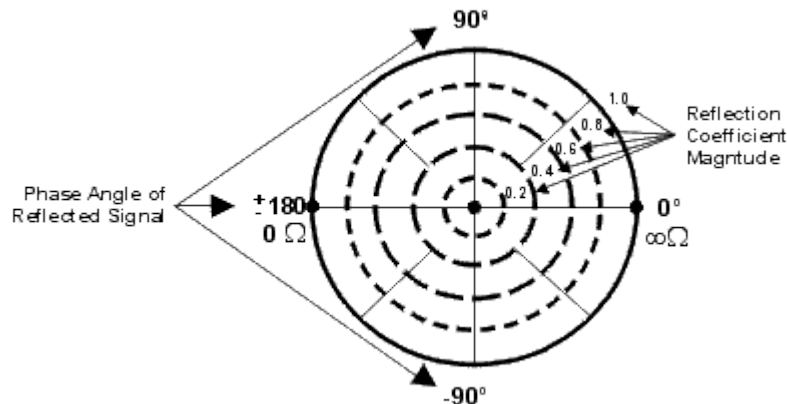

- The dashed circles represent reflection coefficient. The outermost circle represents a reflection coefficient (Γ) of 1, or total reflected signal. The center of the circle represents a reflection coefficient (Γ) of 0, or no reflected signal.
- The radial lines show the phase angle of reflected signal. The right-most position corresponds to zero phase angle, (that is, the reflected signal is at the same phase as the incident signal). Phase differences of 90° , $\pm 180^\circ$, and -90° correspond to the top, left-most, and bottom positions on the polar display, respectively.

Smith Chart Format

The Smith chart is a tool that maps the complex reflection coefficient (Γ) to the test device's impedance. In a Smith chart, the rectilinear impedance plane is reshaped to form a circular grid, from which the series resistance and reactance can be read ($R + jX$).

You can use Markers to display the following:

- Resistance (in units of ohms)
- Reactance as an equivalent capacitance (in units of farads) or inductance (in units of henrys)

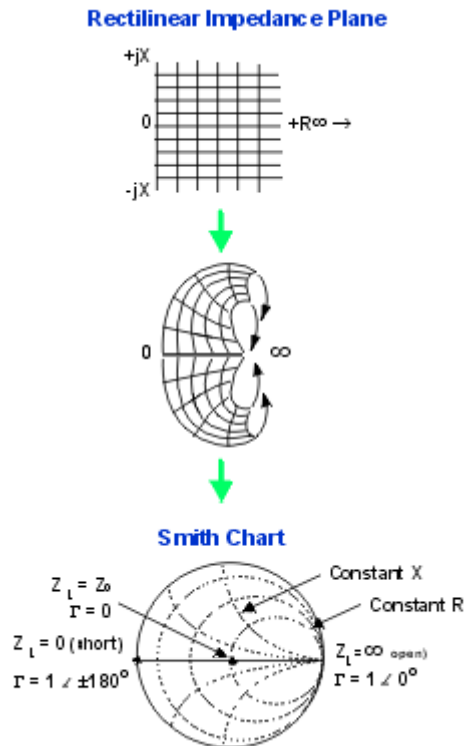

Inverse Smith Chart (also known as Admittance)

Same as standard Smith Chart , except:

- The plot graticule is reversed right-to-left.
- Admittance (in units of siemens) instead of resistance.

Interpreting the Smith Chart

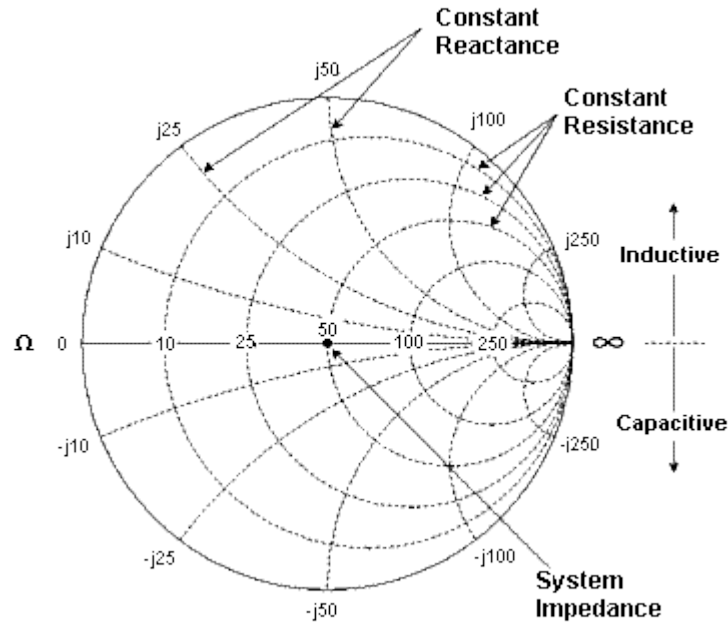

- Every point on the Smith Chart represents a complex impedance made up of a real resistance (r) and an imaginary reactance ($r+jX$)
- The horizontal axis (the solid line) is the real portion of the impedance - the resistance. The center of the horizontal axis always represents the system impedance. To the far right, the value is infinite ohms (open). To the far left, the value is zero ohms (short)
- The dashed circles that intersect the horizontal axis represent constant resistance.
- The dashed arcs that are tangent to the horizontal axis represent constant reactance.
- The upper half of the Smith chart is the area where the reactive component is positive and therefore inductive.
- The lower half is the area where the reactive component is negative and therefore capacitive.

Last modified:

25-Jul-2014 First Release



Scale

The Scale, Reference Level and Reference Position settings (along with [Format](#)) determine how the data trace appears on the VNA screen.

- [Scale, Reference Level and Position](#)
- [Scale Coupling](#)
- [Electrical Delay](#) (Separate topic)
- [Magnitude Offset & Magnitude Slope](#)
- [Phase Offset](#) (Separate topic)

See other 'Setup Measurements' topics

Scale, Reference Level and Position

The Scale, Reference Level and Reference Position settings (along with format) determine how the data trace appears on the VNA screen.

How to set Scale, Reference Level and Position

Using **Hardkey/SoftTab/Softkey**

1. Press **Scale > Main > Scale / Reference Level / Reference Position**.
2. Input the desired value.

Using a mouse

1. Right-click on **Y-axis** annotation or the [trace status](#) label above the grid box.
2. Select **Scale...**

Programming Commands

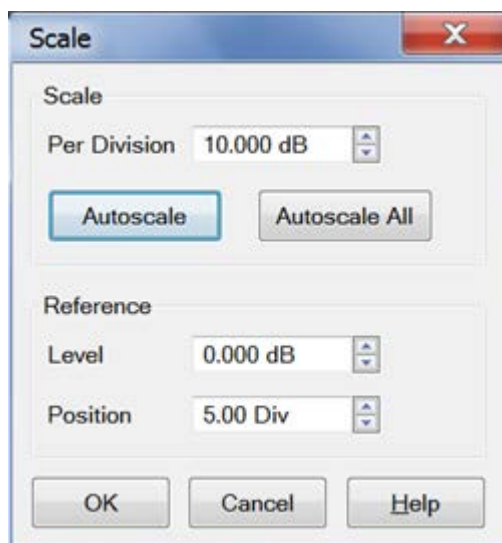

Scale Dialog Box Help / [Scale > Main](#) Softtab Help

Note: The scale settings are set to couple with other traces in each window. The following settings assume that Scale Coupling is set to OFF. [Learn more about Scale Coupling.](#)

Scale

Per Division - Sets the value of the vertical divisions of a rectangular display format. In Polar and Smith Chart formats, scale sets the value of the outer circumference. Range: 0.001 dB/div to 500 dB/div.

Tip: Click on the **Y-axis** labels, then use a mouse scroll wheel to change scale in preset increments

Autoscale - Automatically sets value of the vertical divisions and reference value to fit the ACTIVE data trace within the grid area of the screen. The stimulus values and reference position are not affected.

The analyzer determines the smallest possible scale factor that will allow all the displayed data to fit onto 80 percent of the vertical grid.

The reference value is chosen to center the trace on the screen.

Tip: Double click on the **Y-axis** labels to autoscale the active trace.

Autoscale All - Automatically scales ALL data traces in the ACTIVE WINDOW to fit vertically within the grid area of the screen.

Reference

Level

In rectangular formats, sets the value of the reference line, denoted by  on the VNA screen. Range: -500 dB to 500 dB.

In Polar and Smith chart formats, reference level is not applicable.

Tip: Click on the **Y-axis** labels, then drag up or down to change the reference level in preset increments.

Position

In rectangular formats, sets the position of the reference line. Zero is the bottom line of the screen and ten is the top line. Default position is five (middle).

In Polar and Smith chart formats, reference position is not applicable.

Tip: Click on the triangle , then drag up or down to change the reference position in preset increments.

Scale Coupling

With Scale Coupling enabled, traces that have the same format will have the same Scale, Reference Level, and Reference Position. You can choose to couple the scale of traces that are in the same window, couple the scale of all traces in all windows, or to have NO coupling.

How to set Scale Coupling

Using **Hardkey/SoftTab/Softkey**

1. Press **Scale > Main > Scale Coupling....**

Using a mouse

1. Right-click on the **Y-axis** labels of a window.
2. Select **Scale Coupling....**

◀ Programming Commands ▶

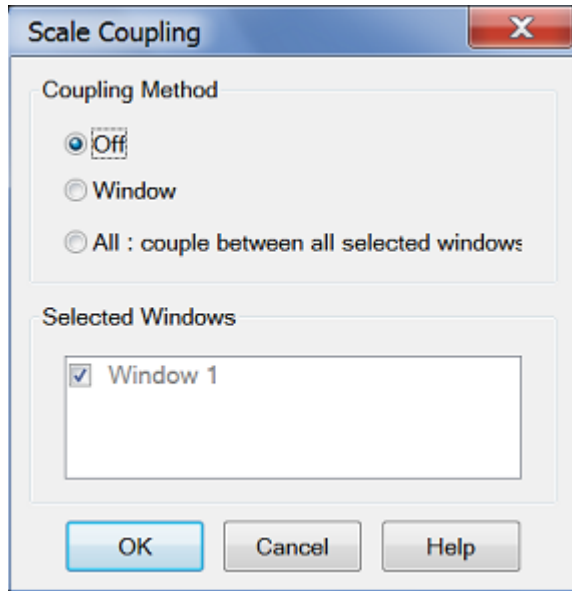

Scale Coupling Dialog Box Help

Allows traces that share the same [format](#) to have the same [Scale](#), [Reference Level](#) and [Reference Position](#).

Coupling Method

Off - No coupling. Traces are scaled individually. Default setting.

Window - All traces with the same format in each selected window share the same scale settings.

All: couple between all selected windows

All traces in ALL selected windows with the same format share the same scale settings.

- When **Window** or **All** coupling is enabled, the scale settings for the active trace are assumed by other coupled traces with the same format.
- When there are traces with a different format present, all traces with that format assume the trace settings of the lowest-numbered trace of that format.
- Once enabled, scale settings for all coupled traces with the same format can be changed with any coupled trace being active.

Selected Windows

Available when either the **Window** or **All** method is selected. Selected windows will participate in scale coupling. All windows are selected by default. Uncheck a checkbox to disable of scale coupling for that window.

About Autoscale and Scale Coupling

Autoscale with Coupling Method

- affects the active trace in the active window. All traces that are coupled to this trace assume the new scale settings of the active trace. This could cause some traces to NOT show on the screen.

Autoscale All with Coupling Method

- **Off** - All traces in the active window are autoscaled independently.

- **Window** - All traces in each selected window are autoscaled to fit within a common set of scaling factors.
- **All** - All traces in all selected windows are autoscaled to fit within a common set of scaling factors.

Magnitude Offset

Magnitude Offset allows to offset the magnitude (not phase) data by a fixed or sloped value in dB. If the display format is Linear Magnitude or Real (unitless), the conversion from dB is performed and the correct amount of offset is implemented.

How to set Magnitude Offset

Using **Hardkey/SoftTab/Softkey**

1. Press **Scale** > **Constants** > **Mag Offset / Mag Slope**.

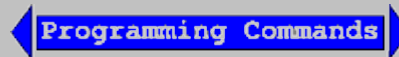

Scale > **Constants** Softtab

The Magnitude offset setting affects only the active trace.

Mag Offset - Offsets the entire data trace by the specified value.

Mag Slope - Offsets the data trace by a value that changes with frequency. The offset slope begins at 0 Hz.

See where this operation is performed in the data processing chain.

Last modified:

23-Jul-2014 First Release

Customize the VNA Screen

You can customize VNA screen by showing or hiding the following display elements.

- [Windows](#) (Separate topic)
- [Display Labels](#)
 - [Trace Status](#)
 - [Y-axis Labels](#)
 - [X-axis Labels](#)
- [Marker Display](#) (Separate topic)
- [Tables](#)
- [Toolbars](#)
 - [Softkey](#)
 - [Hardkey](#)
 - [Port Extension](#)
 - [Transform](#)
 - [Marker](#)
 - [Cal Set Viewer](#)
 - [Title Bars](#)
 - [Active Entry](#)
 - [Status bars](#)
 - [System Date and Time](#)
- [Display Colors](#) (Separate topic)
- [Grid: SOLID | Dotted](#)
 - [Grid Lines](#)
 - [Y-axis Divisions](#)
 - [Show Table](#)
- [Tools](#)
- [Window Title](#)
- [Trace Title](#)
- [Frequency/Stimulus](#)
- [Minimize Application](#)

See Also

Expanded display capabilities of the VNA

[Traces, Channels and Windows on the VNA](#)

See other 'Setup Measurements' topics

Labels

You can display different labels for traces status, Y-axis and X-axis labels.

How to display Labels.

<p>Using Hardkey/SoftTab/Softkey</p> <ol style="list-style-type: none"> 1. Press Display > Display Settings > Customize Display.... 2. Select Labels tab. <p>OR</p> <ol style="list-style-type: none"> 1. Press Marker > Marker Setup > Marker Display.... 2. Select Labels tab. 	<p>Using a mouse</p> <ol style="list-style-type: none"> 1. Right click on any window area. 2. Click Customize Display.... 3. Select Labels tab.
---	---

Programming Commands

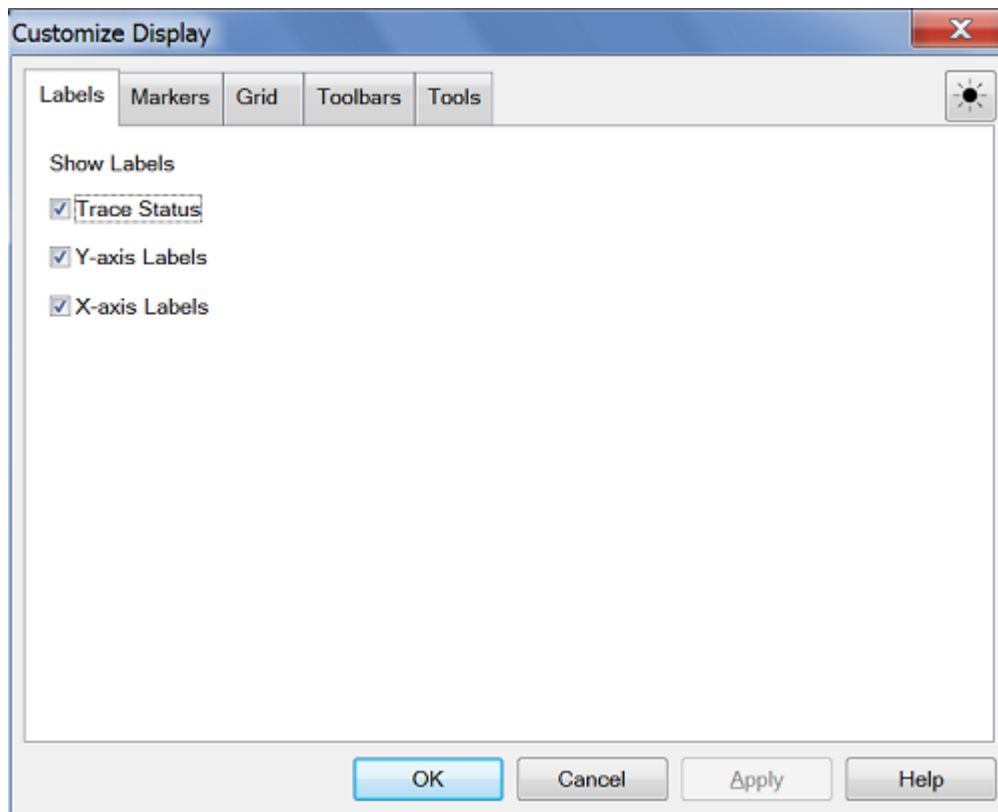

Labels tab Dialog Box Help

Show Labels

Trace Status

Tr 1 S11 LogM 10.00dB/ 0.00dB **Tr 2** S12 LogM 10.00dB/ 0.00dB

Trace status is annotated at the top of each window.

The highlighted trace number indicates **Active Trace**.

Click the title to select a trace.

Trace Status shows the following:

- Trace number (Tr x). This is the trace number of the channel; NOT the window trace number which is used in many programming commands.
- Measurement parameter. This can be replaced with a custom [Trace Title](#).
- Format
- Scaling factor
- Reference level

[How to show/hide Trace Status.](#)

Y-axis Labels

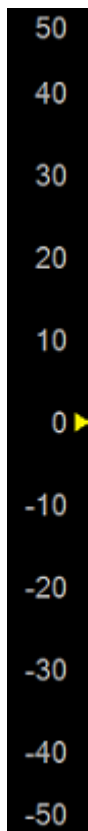

"Y-axis Labels" - allows user to show or hide the y-axis labels.

[How to show/hide Y-axis Labels.](#)

X-axis Labels



"X-axis Freq Resolution" - allows user to choose the resolution of the frequency display. The pull down selects: 6-digit, GHz, MHz, kHz, Hz. It shows 1Hz resolution, but only shows significant digits.

[How to show/hide X-axis Labels.](#)

Grid

How to set VNA Grid and display tables.

Each window can display only one table at a time.

Using [Hardkey/SoftTab/Softkey](#)

1. Press **Display** > **Display Settings** > **Customize Display...**
2. Select **Grid** tab.

OR

1. Press **Marker** > **Marker Setup** > **Marker Display....**
2. Select **Grid** tab.

Using a mouse

1. Right click on any window area.
2. Click **Customize Display....**
3. Select **Grid** tab.

◀ **Programming Commands** ▶

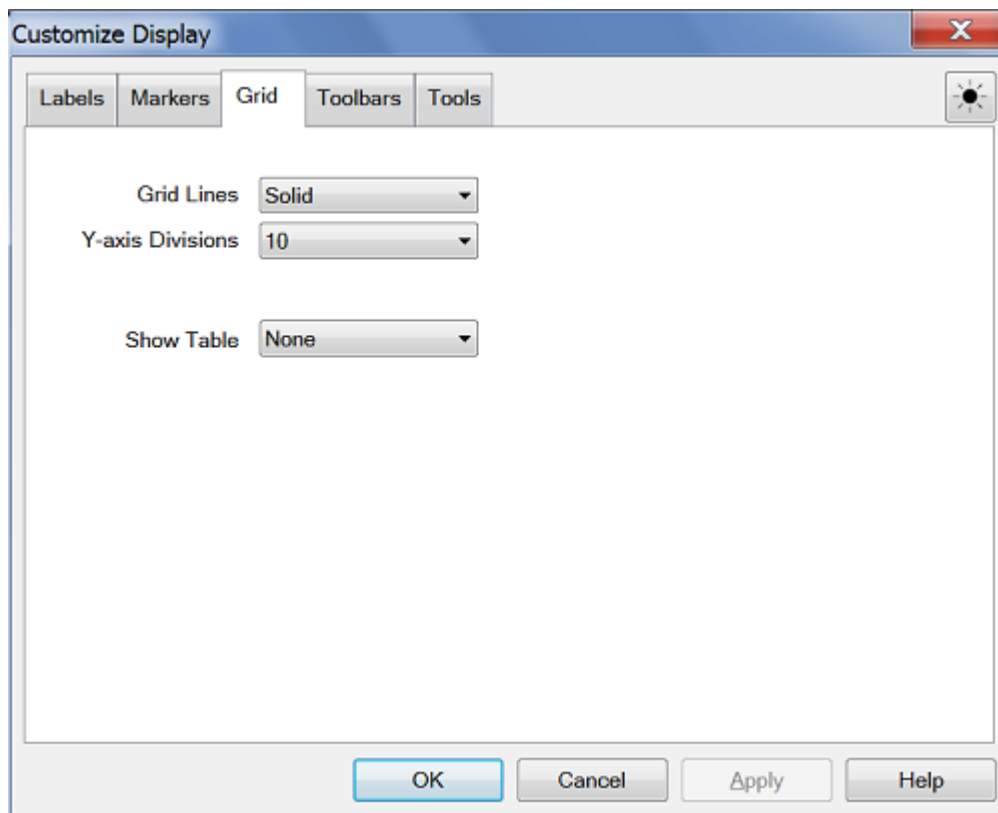
**Grid Dialog Box Help**

Grid Lines: Solid | Dotted - Set whether to display ALL open window grid lines in solid or dotted lines. The selected setting is shown in CAPS. Once set, new windows are created using this setting. Grid lines return to SOLID when the VNA is Preset.

Set the color of the grid using [Display Colors](#).

[How to display grid settings](#)

Y-axis Divisions - Set the desired rows of Y-axis, it can shows 2 to 30.

Show Table

None - Turn OFF the table.

Marker Table

You can display a table of marker settings. These settings include the:

- Marker number
- Marker reference (for delta measurements)
- Frequency
- Time and Distance (for Time Domain measurements)
- Response

[Learn more about Markers](#)

Limit Line Table

You can display, set up, and modify a table of limit test settings. These include:

- Type (MIN, MAX, or OFF)
- Beginning and ending stimulus values
- Beginning and ending response values

[Learn more about Limit Lines.](#)

Segment Sweep Table

You can display, set up, and modify a table of segment sweep settings. These include:

- State (On/Off)
- Start and Stop frequencies
- Number of Points
- IF Bandwidth (if independent levels)
- Power Level (if independent levels)
- Sweep Time (if independent levels)

[Learn more about Segment Sweep.](#)

Toolbars

You can display different toolbars to allow you to easily set up and modify measurements.

How to display Toolbars

Using **Hardkey/SoftTab/Softkey**

1. Press **Display** > **Display Settings** > **Customize Display...**

Using a mouse

1. Right click on any window area.

<p>2. Select Toolbars tab.</p> <p>OR</p> <p>1. Press Marker > Marker Setup > Marker Display...</p> <p>2. Select Toolbars tab.</p>	<p>2. Click Customize Display...</p> <p>3. Select Toolbars tab.</p>
--	---

Programming Commands

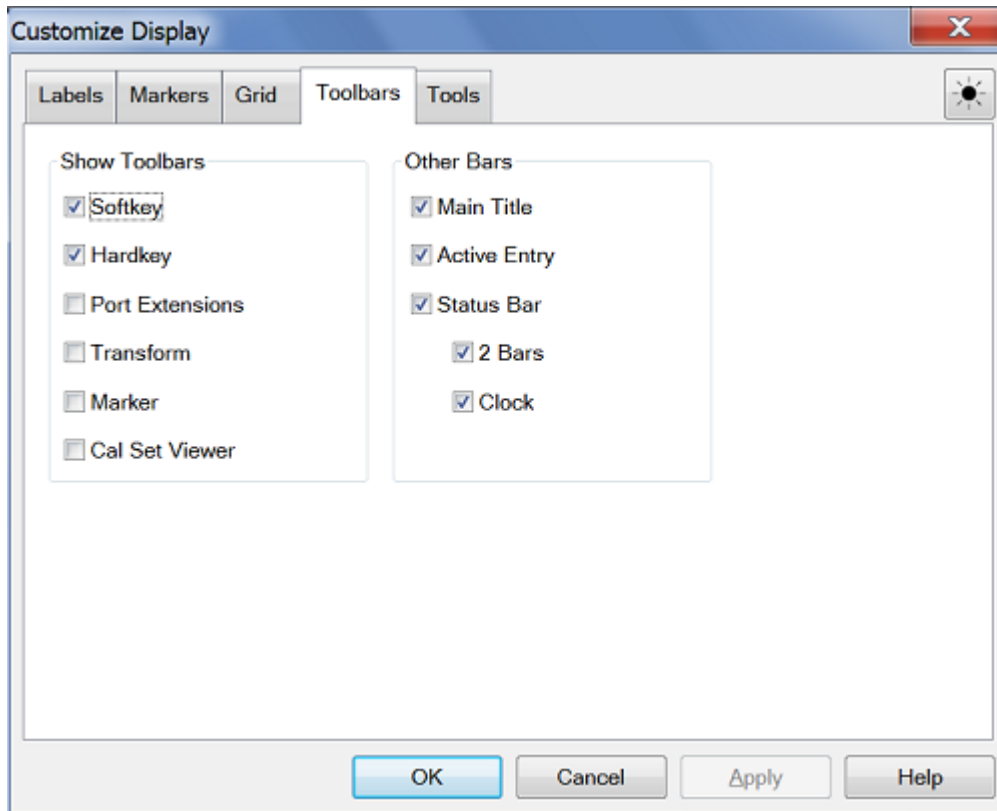

Toolbars Dialog Box Help

Show Toolbar

Note: There is also a Cal Set toolbar available for [Monitoring Error Terms](#)

Softkey

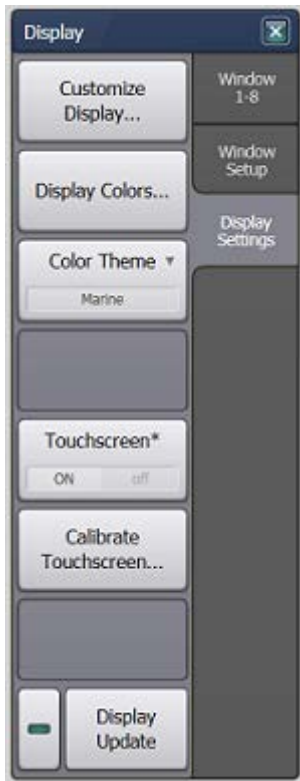

Softkey is combination of softkeys and SoftTab. Softkey are automatically turned ON when one of the 'function' hardkeys is pressed. This setting allows you to turn the softkeys OFF to show more measurement space on the screen. The softkeys will reappear when another function hardkey is pressed.

Hardkey



These keys also known as Front Keys, it performs interface operations that are equivalent to those of keys in the INSTRUMENT keys, RESPONSE keys, STIMULUS keys and UTILITY keys on the front panel of VNA. Learn more.

Port Extensions Toolbar



The Port Extension toolbar allows you to set Port Extensions while viewing the measurement trace. Learn more about [Port Extensions](#).

Transform (Time Domain) Toolbar

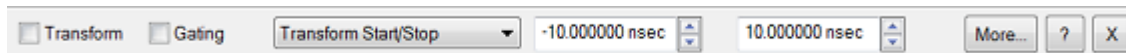

The Time Domain toolbar allows you to do the following:

- Turn **Transform** and **Gating** ON/OFF.
- Change the Start/Stop times for both Transform and Gating.
- **More...** - Launches the Time Domain Transform dialog box.
- **?** - Display the help file.

- **X** - Closes the toolbar.

Markers Toolbar



The markers toolbar allows you to set up and modify markers. It shows:

- Marker number
- Stimulation value
- Marker functions:
 - Delta
 - Max/Min
 - Start/Stop
 - Center/Span

Tip: To use the Front Panel Knob to change marker position, first click the **Stimulus** field of the marker toolbar and then turn the knob.

[Learn more about Markers](#)

Cal Set Viewer Toolbar

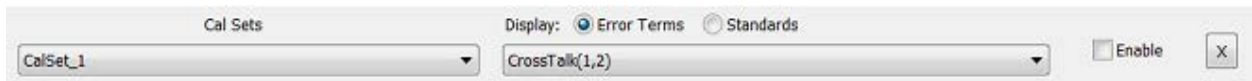

All Off (NOT on softkeys)

This allows you to **hide all toolbars** with a single selection. NOT available on softkeys.

Other Bars

Main Title



The Main Title shows the title of VNA window and Minimize / Maximize icons.

- Checked - Title bars for all VNA window are shown.
- Cleared - Title bars for all VNA window are hidden. This allows more room to display measurement results.

Active Entry Toolbar



When used with softkeys, this area allows numeric values to be entered for settings. From the keyboard, enter G for Giga, M for Mega or milli, K for kilo and so forth.

Status Bar

2 Bars



When enabled, the status bar is displayed along the bottom of the VNA screen. The primary status bar shows the following:

Tip: Right-click on many of these items in the status bar for quick access to settings.

- Active trace
- Active channel
- [Trigger source](#)
- [Channel Trigger State](#) (Hold, Single, Continuous)
- [IF Bandwidth](#)
- [Error correction](#) for the active trace to the [Basic cal](#), [Smart cal](#) and [Calibrate All Channels](#).
 - F: Full Port Calibration, R: Response Calibration, -: Nothing
 -
- [Source Power Calibration](#)
- Simulation
- Service
- [RF power](#)
- Display Update
- [Error messages](#)
- [GPIB status](#): Local (LCL), Remote Talker Listener (RMT), or System Controller (CTL).
- [System Date and Time](#) - Can be set ON or OFF. [How to show/hide the VNA clock](#).
-

Note: A second level status bar appears when using External Test Set Control or [Interface control](#).

The status bar state (ON or OFF) will not change when the VNA is Preset.

Clock (System Date and Time)

The VNA system date and time can be shown in the far right corner of the status bar.

The format is: year-month-day hr:min and can NOT be changed.

To hide the clock, right click the mouse on the clock and then click **Hide Clock**.

Learn how to set the VNA time settings.

Tools

How to set Tools settings

Using **Hardkey/SoftTab/Softkey**

1. Press **Display** > **Display Settings** > **Customize Display...**
2. Select **Tools** tab.

OR

1. Press **Marker** > **Marker Setup** > **Marker Display....**
2. Select **Tools** tab.

Using a mouse

1. Right click on any window area.
2. Click **Customize Display....**
3. Select **Tools** tab.

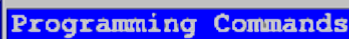
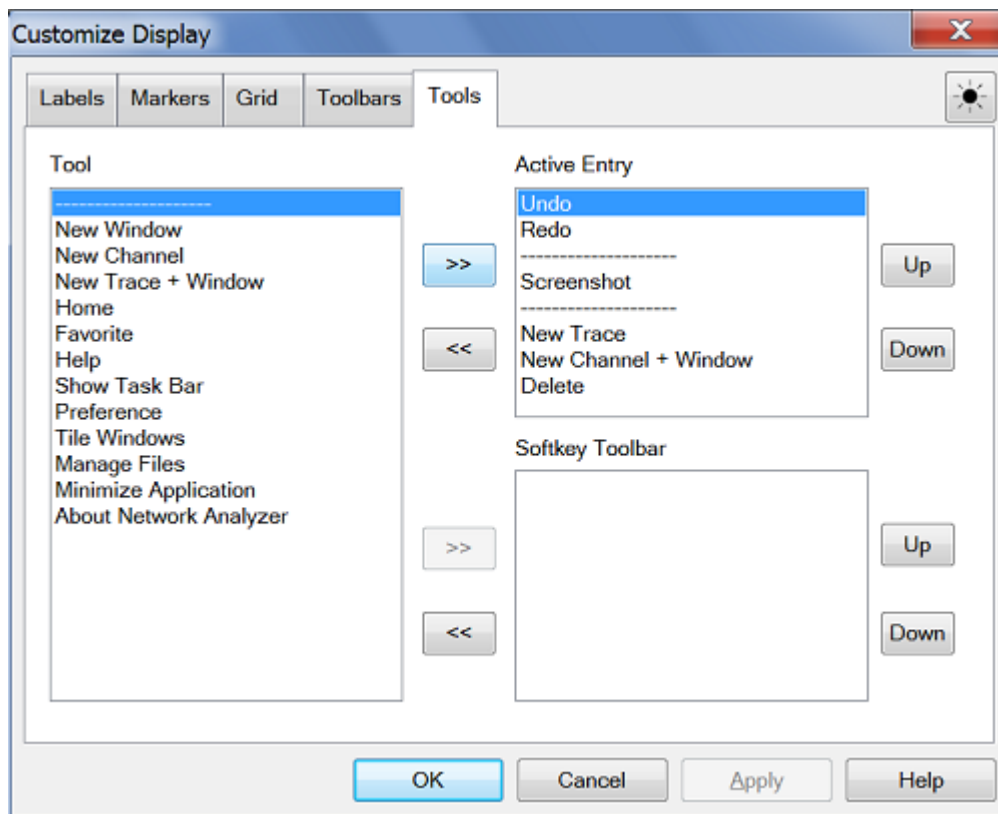
 Programming Commands

Tools Dialog Box Help

Tools function to create a shortcut icon to display on Active Entry or Softkey Toolbar. The maximum icons can display on Active Entry is 9, while Softkey Toolbar is 12.

New Window - Create a new window.



New Channel - Create a new channel on active window.



New Channel + Window - Create a new trace and channel to a new window.



New Trace - Create a new trace on active window.



New Trace + Window - Create a new trace to a new window, but the channel is remain.



Home - Display VNA Home softkeys.



Favorite - Set favorite application.



Help - Shows Help file.



Show Task Bar - Shows Window bar.



Preference - Display preference dialog box.



Tile Windows



Manages Files - Use to manage the saved files in the "D:\\" drive folder. [Learn more.](#)



Minimize Application - Restore VNA screen. [Learn more.](#)



About Network Analyzer - Display [About Network Analyzer](#) dialog box.



Undo - Recover to previous version. [Learn more.](#)



Redo - Set to latest version. [Learn more.](#)



Screenshot - Save screen figure to D drive (D:\).



Delete - Delete the active window.



Window Title

You can create and display a title for each **window**.

- The limit is set by the number of windows that are displayed.
- The title (Window 1) is annotated in the upper-left of the window as follows:



How to enter a Window Title.	
<p>Using Hardkey/SoftTab/Softkey</p> <ol style="list-style-type: none"> 1. Press Display > Window Setup > Window Title... 	<p>Using a mouse</p> <ol style="list-style-type: none"> 1. Move a cursor in the grid and then right click. 2. Select Title...

A Window Title dialog box appears as per below:

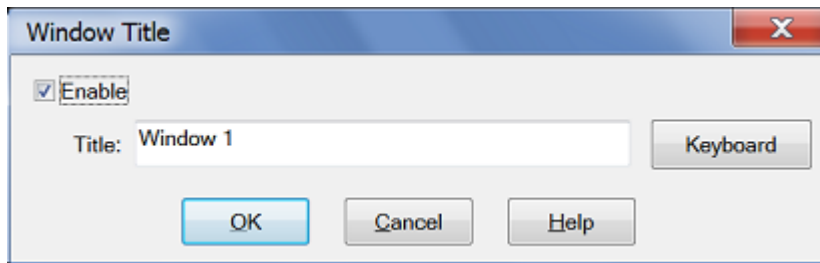

1. Click **Enable**, then type the window title. Click **Keyboard** to type with a mouse.
2. To remove the window title, clear the **Enable** checkbox or delete the text from the dialog entry.

Trace Title

A Trace Title overwrites the Measurement Parameter in the [Trace Status](#) area, the [Status Bar](#) and [hardcopy prints](#).

- This title has priority over [Equation Editor](#) titles.
- The practical limit is about 70 characters if there is only one trace.
- Spaces are accepted but not displayed; use underscores.
- The title is annotated as follows:

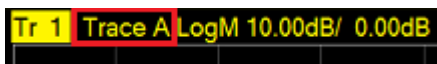

How to enter a Trace Title.	
<p>Using Hardkey/SoftTab/Softkey</p> <ol style="list-style-type: none"> 1. Press Trace > Trace Setup > Trace 	<p>Using a mouse</p> <ol style="list-style-type: none"> 1. Right-click on the trace status area above the

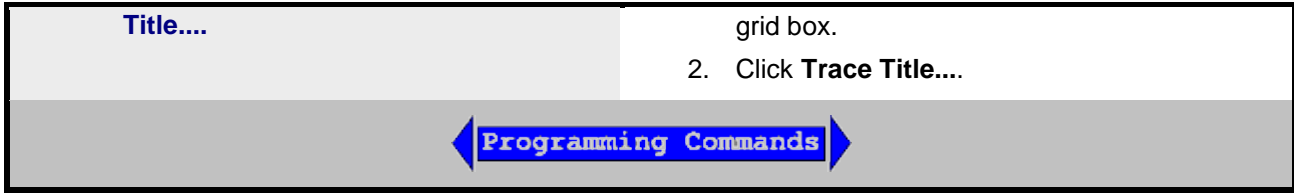

A Trace Title dialog box appears as per below:

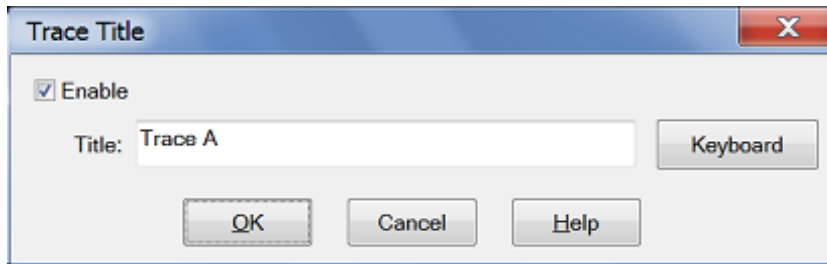

1. Click **Enable**, then type the trace title. Click **Keyboard** to type with a mouse.
2. To remove the trace title, clear the **Enable** checkbox or delete the text from the dialog entry.

Frequency/Stimulus



Frequency/stimulus information is displayed at the bottom of each window on the screen. It shows:

- Channel number
- Start value
- Stop value

[How to show/hide Frequency/Stimulus information](#)

Minimize Application

The Network Analyzer application can be minimized to show the desktop and Windows taskbar.

1. Click **System** > **Main** > **Minimize Application**.

To restore the VNA application, double-click the VNA application on the desktop.

Last modified:

29-Sep-2015 First Release



Copy Channels

Copy channels allows you to make a duplicate channel of the same [Measurement Class](#) and with the same stimulus conditions as an existing channel.

- [Why Copy Channels](#)
- [How to Copy Channels](#)
- [List of Channel Settings](#)

Note: Copy Channels CAN be used with VNA Applications, such as FCA, Gain Compression, or Noise Figure.

Other Setup Measurements Topics

Why Copy Channels

Copy channel settings if you need to create several channels that have slightly different settings.

For example, if you have an amplifier that you want to characterize over a frequency span with several different input power levels.

Follow these steps:

1. Create one measurement with your optimized channel settings.
2. Copy that channel to new channels.
3. Change the power level on the new channels.

How to Copy Channels

The alternative to using Copy Channels is to create new default measurements on new channels. Then, change every channel setting to your new requirement. This is very time consuming and thus shows the benefit of the Copy Channels feature.

How to Copy Channels

Using **Hardkey/SoftTab/Softkey**

1. Press **Channel** > **Channel Setup** > **Copy Channel**.
2. Click **Copy to Active Window/Copy to New Window/Copy Channel...**

Programming Commands

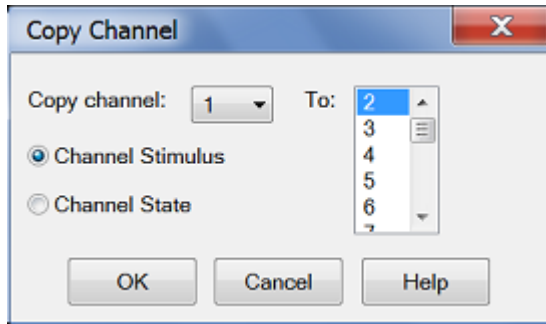

Copy Channel dialog box help

Copies an existing channel's settings to another channel. Measurement traces from the source channel are NOT copied.

Copy channel (also known as '**Source**' channel): Select a channel to copy.

to (also known as '**Destination**' channel): Scroll to select a channel to copy settings to. Compatible channel numbers that are currently being used are highlighted. They can be selected and overwritten.

The following are compatible destination channels:

- A channel that does not yet exist. The new channel is created with the channel's default measurement.
- A channel of the **same** [Measurement Class](#) as the source. The existing measurements remain on the destination channel.
- A channel of any Measurement Class that contains no measurements. Again, the destination channel is created with the channel's default measurement.

Notes:

- You can copy channel settings to **ONLY** one new or existing channel. Repeat this operation to copy to more than one channel.
- The source channel is **ALWAYS** copied to the Active window. If you want the destination channel in a separate window, first create a compatible new measurement in a new window. Then make sure it is the Active window before you copy the channel into it.
- The measurement in the destination channel becomes the active measurement.

For example:

1. **Source** channel 1: Standard S21 measurement
2. **Destination** NEW channel 2
3. **Result:** Source channel 1, S21 Measurement AND channel 2, S11 measurement. Both with same stimulus settings and in the same window. Channel 2, S11 measurement is the active measurement.

For more information see [Traces, Channels and Windows on the VNA](#)

List of Channel Settings

- [Frequency Span](#)
- [Power](#)
- [Cal Set usage](#)
- [Source Power Cal data](#)
- [IF Bandwidth](#)

1. Set Up a Measurement

- Number of Points
 - [Sweep Settings](#)
 - [Average](#)
 - [Trigger \(some settings\)](#)
-

Last modified:

29-Sep-2015 First Release

Undo/Redo Settings

If make an incorrect setting, you can quickly recover by selecting Undo. If Undo incorrectly a setting, you can Redo the undone setting.

- Undo and Redo applies ONLY to selected VNA settings.
- The Undo stack remembers 16 levels of Undo-able settings.

How to Undo or Redo a setting

Using

Hardkey/SoftTab/Softkey

1. Press **Undo** > **Main**.
2. Click **Undo** or **Redo**.

Using a mouse

1. Click **Undo** and **Redo** Icons on Active Entry or Softkey Toolbar.

SCPI programming and Undo/Redo:

- There are NO Programming commands to invoke Undo/Redo.
- Programing commands are NOT Undo-able.
- The Undo stack is cleared when programming commands are sent to the VNA.

Tips:



Undo Redo

- Undo/Redo can be stored to a User Key or Favorite softkey.
- With a keyboard:
 - Undo --> Ctrl+Z
 - Redo --> Ctrl+Y

Clear Undo History

To clear the Undo stack, press **Undo** > **Main** > **Clear Undo History**.

Undo and Security

- Undo/Redo is disabled with **High** and **Extra** security levels. [Learn more](#).
- State files that are saved for Undo/Redo purposes (for example: Preset) are deleted when any of the following occur:
 - The VNA Security level is changed
 - The VNA App is started or closed.

Selected Undo-able settings

You can Undo or Redo the following VNA settings:

Note: There are several VNA settings that are NOT Undo-able. Because of this, when you attempt to Undo a long sequence of operations, it is unlikely that the original state can be recreated exactly.

- [Preset](#)

- [File Recall](#)
- [Frequency Settings](#):
 - For Standard Class: Start, Stop, Center, Span, CW
 - For SMC: Mixer Setup dialog Apply
- [Turn off Marker](#) and [Marker All OFF](#)
- Number of Points
- [Power Level](#) - most applications and S-parameters
- [Add or Change Measurement Class](#)
- [Turn OFF Channel](#)
- [Close Window](#)
- [New Channel, new Window and new Trace](#)
- [Delete Trace](#)
- Window Tile
- Move Trace, Drag Trace
- [Autoscale All, Autoscale](#)
- [Scale, Reference Level, Reference Position](#)
- [Scale Coupling dialog](#)
- [Electrical Delay](#)
- [Phase Offset](#)
- Measurement Setups dialog
- [Format](#)
- [Sweep Type](#)
- [Data -> Memory](#)
- Single Marker Searches ([Max](#), [Min](#), [Target](#), [Peak...](#))
- Multi-marker Searches ([Bandwidth](#), [Power Saturation](#), [Normal Operating Pt](#))
- Change a Marker's stimulus value: softkeys, dialog or drag
- Change cell in [Segment Table](#)
- Mechanical Settings dialog

Last modified:

29-Sep-2015 First Release

2. Optimize a Measurement

Dynamic Range

Dynamic range is the difference between the analyzer receiver's maximum input power and the minimum measurable power (noise floor). For a measurement to be valid, input signals must be within these boundaries.

Increasing dynamic range is important if you need to measure very large variations in signal amplitude, such as filter bandpass and rejection. The dynamic range is shown below for an example measurement.

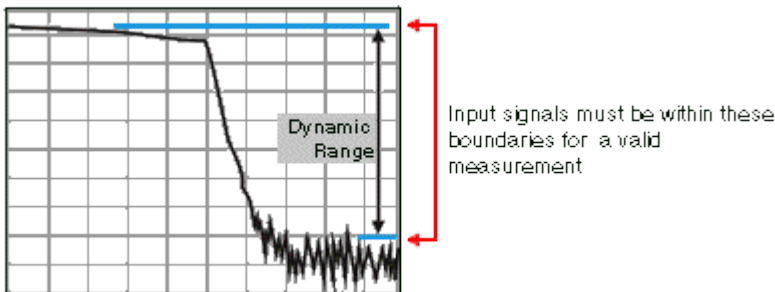

To help reduce measurement uncertainty, the analyzer dynamic range should be greater than the response that the DUT exhibits. For example, measurement accuracy is increased when the DUT response is at least 10 dB above the noise floor. The following methods can help you increase the dynamic range.

- [Increase the Device Input Power](#)
- [Reduce the Receiver Noise Floor](#)

Other topics about Optimizing Measurements

Increase Device Input Power

Increase the DUT input power so that the analyzer can more accurately detect and measure the DUT output power. However, use caution - too much power can damage the analyzer receiver or cause compression distortion.

Caution! Test Port RF Power input damage level: +27 dBm.

[See how to increase input power to the device](#)

Tip: You can further increase dynamic range by using an external booster amplifier to increase the input power to the DUT. See High Power Amplifier Measurements.

Reduce the Receiver Noise Floor

You can use the following techniques to lower the noise floor and increase the analyzer's dynamic range.

- Reduce crosstalk between the VNA receivers when measuring signals close to the noise floor. See [Receiver Crosstalk](#).)
- Use **Sweep Averaging** - learn more about [Sweep Average](#)
- Reduce the **IF Bandwidth** - learn more about [IF Bandwidth](#).
- In [Segment sweep](#) mode each segment can have its own IF bandwidth. For example, when measuring a filter:

2. Optimize a Measurement

- In the passband, the IF bandwidth can be set wider for a fast sweep rate, as long as high-level trace noise is kept sufficiently small.
- In the reject band, where noise floor contributes significantly to measurement error, the IF bandwidth can be set low enough to achieve the desired reduction in average noise level.

Last Modified:

29-Sep-2015 First Release



Phase Measurement Accuracy

You can increase the accuracy of phase measurements by using the following VNA features.

- [Electrical Delay](#)
- [Phase Offset](#)
- [Spacing Between Frequency Points \(Aliasing\)](#)

See Also

[Port Extensions](#)

[Comparing the VNA Delay Functions](#)

Phase Control

Phase Coherent Measurements

[Learn more about Phase measurements](#)

Electrical Delay

Electrical delay is a mathematical function that simulates a variable length of lossless transmission line.

Use the electrical delay feature to compensate for the linear phase shift through a device. This feature allows you to look at only the [deviation from linear phase](#) of the device.

You can set the electrical delay independently for each measurement trace.

How to set Electrical Delay

Using **Hardkey/SoftTab/Softkey**

1. Press **Scale** > **Electrical Delay**

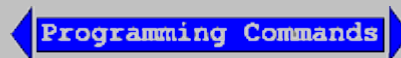

Electrical Delay dialog box help

Electrical Delay - Specifies the value of delay added or removed, in Time or Distance. This compensates for the linear phase shift through a device. You can set the electrical delay independently for each measurement trace.

Velocity Factor - Specifies the velocity factor that applies to the medium of the device that was inserted after the measurement calibration. The value for a polyethylene dielectric cable is 0.66 and 0.7 for PTFE dielectric. 1.0 corresponds to the speed of light in a vacuum.

Velocity factor can also be set from the [Port Extensions](#) dialog and Time Domain Distance Marker Settings.

Softkey Display - Allows to enter delay in either time or distance using the softkeys and [Active Entry toolbar](#).

Distance Units - Select from Meters, Inches, or Feet. The step size will not change automatically when this value is changed. [Learn more about Step Size.](#)

Media

Coax - Select if the added length is coax. Also specify the velocity factor of the coax.

Waveguide - Select if the added length is waveguide. Also specify the low frequency cutoff of the waveguide.

Cutoff Freq - Low frequency cutoff of the waveguide.

Learn about [Electrical Delay](#) (scroll up)

Phase Offset

Phase offset mathematically adjusts the phase measurement by a specified amount, up to 360°. Use this feature in the following ways:

- **Improve the display of a phase measurement.** This is similar to the way you would change the reference level in an amplitude measurement. Change the phase response to center or align the response on the screen.
- **Emulate a projected phase shift in your measurement.** For example, if you know that you need to add a cable and that the length of that cable will add a certain phase shift to your measurement, you can use phase offset to add that amount and simulate the complete device measurement.

How to set Phase Offset

Using **Hardkey/SoftTab/Softkey**

1. Press **Scale** > **Constants** > **Phase Offset**

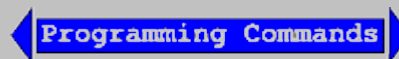
**Phase Offset dialog box help**

Phase Offset Type a value or use the up and down arrows to select any value.

Learn about [Phase Offset](#) (scroll up)

Spacing Between Frequency Points (Aliasing)

The analyzer samples data at discrete frequency points, then connects the points, creating a trace on the screen.

If the phase shift through a device is $>180^\circ$ between adjacent frequency points, the display can look like the phase slope is reversed. This is because the data is undersampled and aliasing is occurring.

If you are measuring group delay and the slope of the phase is reversed, then the group delay will change sign. For example, the following graphic shows a measurement of a SAW bandpass filter.

- The left measurement has 51 points and indicates the group delay is negative, which is a physical impossibility. That is, the response is below 0 seconds reference line.
- The right measurement shows an increase to 201 points which indicates the group delay is positive. That is, the response is above the 0 seconds reference line.

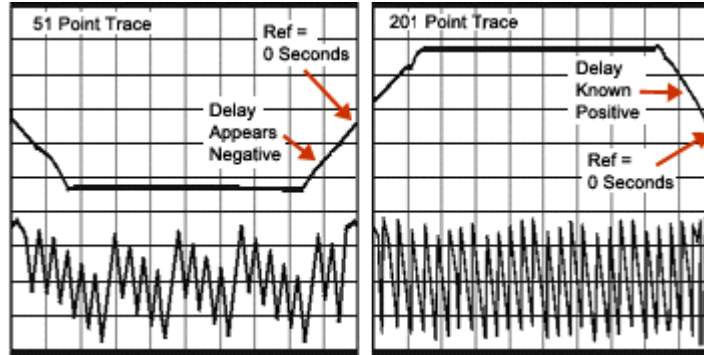

Tip: To check if aliasing might be occurring in a measurement, either increase the number of points or [reduce the frequency span.](#)

Last modified:

25-Jul-2014 First Release



Electrically-Long Device Measurements

A signal coming out of a device under test may not be exactly the same frequency as the signal going in to a device at a given instant in time. This can sometimes lead to inaccurate measurement results. You can choose between two techniques to eliminate this situation and increase measurement accuracy.

- [Why Device Delay May Create Inaccurate Results](#)
- [Solutions to Increase Measurement Accuracy](#)
 - [Slow the Sweep Speed](#)

Other topics about Optimizing Measurements

Why Device Delay May Create Inaccurate Results

The following graphic shows an example of this situation:

- In the network analyzer, the source and receiver are **phase** locked together and sweep simultaneously through a span of frequencies.
- The signal flow through the Device Under Test (DUT) is shown as different colors for different frequencies.
- You can see as a stimulus frequency travels through the **DUT**, the analyzer tunes to a new frequency just before the signal arrives at the receiver. This causes inaccurate measurement results.

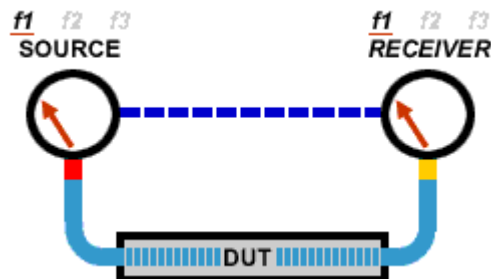

If the analyzer is measuring a long cable, the signal frequency at the end of the cable will lag behind the network analyzer source frequency. If the frequency shift is appreciable compared to the network analyzer's IF **detection** bandwidth (typically a few kHz), then the measured result will be in error by the roll-off of the IF filter.

Note: There is no fixed electrical length of a device where this becomes an issue. This is because there are many variables that lead to measurement speed. When high measurement accuracy is critical, lower the sweep speed until measurement results no longer change.

Solutions to Increase Measurement Accuracy

Choose from the following methods to compensate for the time delay of an electrically long device.

Slow the Sweep Speed

The following methods will slow the sweep speed.

- [Increase the Sweep Time](#)
- Increase the Number of Points

E5080A

- [Use Stepped Sweep](#)
- [Set Dwell Time](#)

Last modified:

12-Aug-2014 First Release



Reflection Accuracy on Low-Loss 2-Port Devices

To make accurate reflection measurements that have a 1-port calibration, you should terminate the unmeasured port.

- [Why Terminate the Unmeasured Port](#)
- [How to Terminate the Unmeasured Port](#)
- [Resulting Measurement Uncertainty](#)

Other topics about Optimizing Measurements

Why Terminate the Unmeasured Port

A 2-port calibration corrects for all 12 twelve error terms. A 1-port calibration corrects for directivity, source match and frequency response, but not load match. Therefore, for highest accuracy, you must make the load match error as small as possible. This especially applies for low-loss, bi-directional devices such as filter passbands and cables. You do not need to be concerned with load match when you are measuring a device with high reverse isolation, such as an amplifier.

How to Terminate the Unmeasured Port

Use one of the following methods:

- Connect a high-quality termination load (from a calibration kit, for example) to the unmeasured port of your device. This technique yields measurement accuracy close to that of a Full SOLT 2-port calibration.
- Connect the unmeasured port of your device directly to the analyzer, inserting a 10 dB precision attenuator between the device output and the analyzer. This improves the effective load match of the analyzer by approximately twice the value of the attenuator, or 20 dB.

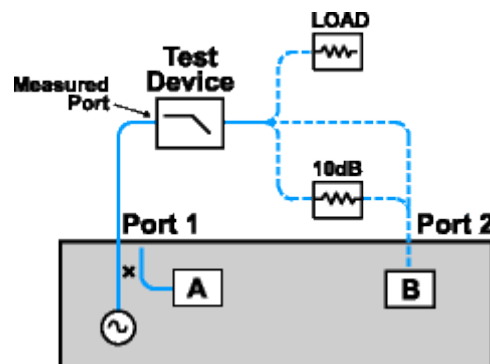

Resulting Measurement Uncertainty

The following graph illustrates the measurement uncertainty that results from terminating with and without a precision 10 dB attenuator on the output of the test device.

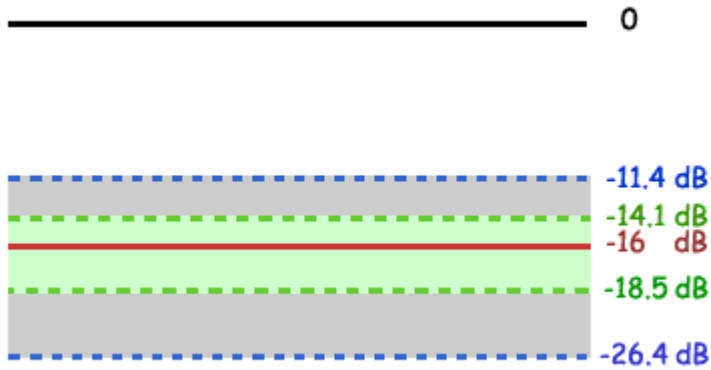

Legend

- Filter Reflection
- Uncertainty **with** attenuator
- Uncertainty **without** attenuator

The calculations below show how adding a high-quality 10 dB attenuator improves the load match of the analyzer.

Note: The corresponding linear value is shown in parentheses.

Network Analyzer:

$$\text{Load match (NA}_{LM}) = 18 \text{ dB } (.126)$$

$$\text{Directivity (NA}_{D}) = 40 \text{ dB } (.010)$$

Filter:

$$\text{Insertion loss (F}_{IL}) = 1 \text{ dB } (.891)$$

$$\text{Return loss (F}_{RL}) = 16 \text{ dB } (.158)$$

Attenuator:

$$\text{Insertion loss (A}_{IL}) = 10 \text{ dB } (.316)$$

$$\text{SWR (A}_{SWR}) = 1.05 (.024)$$

$$32.26 \text{ dB Return Loss}$$

Calculations:

	Without Attenuator	With Attenuator
ρ_{NA}	$= (F_{IL}) * (NA_{LM}) * (F_{IL})$ $= (.891) * (.126) * (.891)$ $= .100$	$= (F_{IL}) * (A_{IL}) * (NA_{LM}) * (A_{IL}) * (F_{IL})$ $= (.891) * (.316) * (.126) * (.316) * (.891)$ $= .010$
$\rho_{Attenuator}$	NA	$= (F_{IL}) * (A_{SWR}) * (F_{IL})$ $= (.891) * (.024) * (.891)$ $= .019$
Worst Case Error (E_{wc})	$= \rho_{NA}$ $= .1$	$= \rho_{NA} + \rho_{Attn.}$ $= .01 + .019$ $= .029$
Uncertainty Adds	$= -20\log(F_{RL}) + (E_{WC}) + (NA_D)$ $= -20\log(.158) + (.100) + (.010)$ $= 11.4 \text{ dB}$	$= -20\log(F_{RL}) + (E_{WC}) + (NA_D)$ $= -20\log(.158) + (.029) + (.010)$ $= 14.1 \text{ dB}$
Uncertainty Subtracts	$= -20\log(F_{RL}) - (E_{WC}) - (NA_D)$ $= -20\log(.158) - (.100) - (.010)$ $= 26.4 \text{ dB}$	$= -20\log(F_{RL}) - (E_{WC}) - (NA_D)$ $= -20\log(.158) - (.029) - (.010)$ $= 18.5 \text{ dB}$



Measurement Stability

There are several situations that can cause unstable measurements. To ensure that you are making repeatable measurements, you can use various methods to create a stable measurement environment.

- [Frequency Drift](#)
- [Temperature Drift](#)
- [Inaccurate Measurement Calibrations](#)
- [Device Connections](#)

Other topics about Optimizing Measurements

Frequency Drift

The analyzer frequency accuracy is based on an internal 10 MHz frequency oscillator. See [Technical Specifications](#) for stability and aging specifications.

If your measurement application requires better frequency accuracy and stability, you can override the internal frequency standard and provide your own high-stability external frequency source through the 10 MHz Reference Input connector on the rear panel.

Temperature Drift

Thermal expansion and contraction changes the electrical characteristics of the following components:

- Devices within the analyzer
- Calibration kit standards
- Test devices
- Cables
- Adapters

To reduce the effects of temperature drift on your measurements, do the following.

- Switch on the analyzer 1/2 hour before performing a measurement calibration or making a device measurement.
- One hour before you perform a measurement calibration, open the case of the calibration kit and take the standards out of the protective foam.
- Use a temperature-controlled environment. All specifications and characteristics apply over a 25 °C \pm 5 °C range (unless otherwise stated).
- Ensure the temperature stability of the calibration kit devices.
- Avoid handling the calibration kit devices unnecessarily during the calibration procedure.
- Ensure the ambient temperature is \pm 1°C of the measurement calibration temperature.

Inaccurate Measurement Calibrations

If a measurement calibration is inaccurate, you will not measure the true response of a device under test. To ensure that your calibration is accurate, you should consider the following practices:

- Perform a measurement calibration at the points where you connect the device under test, that is, the reference plane.

2. Optimize a Measurement

- If you insert any additional accessory (cable, adapter, attenuator) to the test setup after you have performed a measurement calibration, use the port extensions function to compensate for the added electrical length and delay.
- Use calibration standards that match the definitions used in the calibration process.
- Inspect, clean, and gage connectors. See [Connector Care](#).

See [Accurate Measurement Calibrations](#) for more detailed information.

Device Connections

Good connections are necessary for repeatable measurements. To help make good connections, do the following:

- Inspect and clean the connectors for all of the components in the measurement setup.
- Use proper connection techniques.
- Avoid moving the cables during a measurement.

Last Modified:

29-Sep-2015 First Release



Noise Reduction Techniques

Random electrical noise which shows up in the analyzer receiver chain can reduce measurement accuracy. The following VNA functions help reduce trace noise and the noise floor which can lead to better dynamic range and more accurate measurements.

Note: The trace noise in microwave PNAs becomes worse below 748 MHz and is especially obvious between 10 MHz and 45 MHz. See [Reduce IFBW](#).

- [Averaging](#)
- [IF Bandwidth](#)
- [Trace Smoothing](#)

See Also

[Group Delay](#)

[Increase Dynamic Range](#)

VNA data processing map.

Other topics about Optimizing Measurements

Averaging

Averaging is a feature that reduces the effects of random noise on a measurement. The VNA computes **each data point** based on the average of several measurements. You determine the number of measurements by setting the Average factor. The higher the average factor, the greater the amount of noise reduction.

Effects of Sweep Average

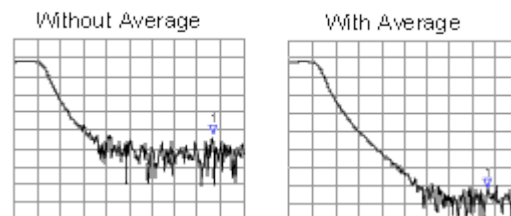

Both **Averaging** and [IF Bandwidth](#) can be used for the same benefit of general noise reduction. For minimizing very low noise, Averaging is more effective than reducing IF bandwidth. Generally, Averaging takes slightly longer than IF bandwidth reduction to lower noise, especially if many averages are required. Also, changing the IF bandwidth after calibration results in [uncertain accuracy](#).

How to Set Averaging

Using **Hardkey/SoftTab/Softkey**

1. Press **Avg** > **Averaging** > Enter the Averaging number

◀ **Programming Commands** ▶

IF Bandwidth

The VNA converts the received signal from its source to a lower intermediate frequency (IF). The bandwidth of the IF bandpass filter is adjustable from 40 kHz (for most VNA models) down to a minimum of 1 Hz.

Reducing the IF receiver bandwidth reduces the effect of random noise on a measurement. Each tenfold reduction in IF bandwidth lowers the noise floor by 10 dB. However, narrower IF bandwidths cause longer sweep times.

- **Channel wide** - IF bandwidth can be set independently for each channel
- **Segment sweep** - IF bandwidth can be set independently for each segment of segment sweep.
- **Calibration** - Changing the IF bandwidth after calibration will cause a '[C-delta](#)' correction level, which means that calibration accuracy is uncertain.

Effect of Reducing IF Bandwidth

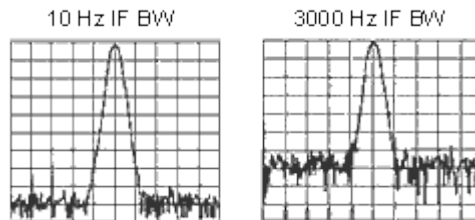

How to set IF Bandwidth

Using **Hardkey/SoftTab/Softkey**

1. Press **Avg** > **IF Bandwidth** > Enter the IF Bandwidth value

Using a mouse

1. Right click on the BW icons on the status bar.
2. Select on **IF Bandwidth....**

◀ Programming Commands ▶

IF Bandwidth dialog box help

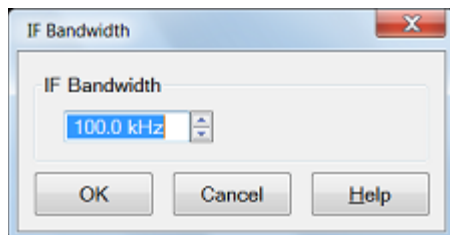

IF Bandwidth Specifies the IF (receiver) bandwidth. The value of IF bandwidth is selected by scrolling through the values available in the IF bandwidth text box. The IF BW is set independently for each channel.

The IF bandwidth is automatically set to equal to or less than 1/5 of each measurement frequency.

When **LF Auto BW** is checked, the actual IF Bandwidths used are:

- From 53+ MHz to **175 MHz**: $30,000\text{Hz} * .025 = 750\text{ Hz}$ (next higher selectable value: **1 kHz**.)
- From 175+ MHz to **250 MHz**: $30,000\text{Hz} * .15 = 4.5\text{ kHz}$ (next higher selectable value: **5 kHz**.)
- From 250+ MHz to 396 MHz: $30,000\text{Hz} * .5 = 15\text{ kHz}$
- From 396+ MHz to stop sweep = 30 kHz

Trace Smoothing

Trace smoothing averages a number of adjacent data points to smooth the displayed trace. The number of adjacent data points that get averaged together is also known as the smoothing aperture. You can specify aperture as either the number of data points or the percentage of the x-axis span.

Trace Smoothing reduces the peak-to-peak noise values on broadband measured data. It smooths trace noise and does not increase measurement time significantly.

Because Trace Smoothing follows Format in the VNA data processing map, the formatted data is smoothed. Smoothing is automatically turned off if the format is Polar or Smith Chart.

[Learn more about Data Format Types.](#)

See the VNA data processing map.

Tips:

- Start with a high number of display points and reduce until you are confident that the trace is not giving misleading results.
- Do not use smoothing for high-resonance devices, or devices with wide trace variations. It may introduce misleading information.
- Smoothing is set independently for each trace.

Effects of Smoothing on a Trace

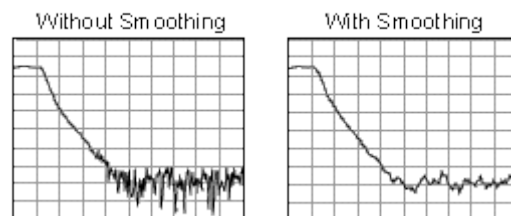

How to set Trace Smoothing

Using **Hardkey/SoftTab/Softkey**

1. Press **Avg** > **Smoothing** > **Smoothing ON|OFF**

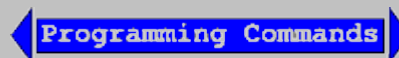

Smoothing When turned ON, smoothing is applied to the displayed trace.

Smooth Percent Specify percent of the swept stimulus span to smooth. For example, for a trace that contains 100 data points, and specify a percent of span = 11%, then the number of data points that are averaged is 11.

Smooth Points Specify the number of adjacent data points to average.

Last modified:

29-Sep-2015 First Release



Crosstalk

Crosstalk is energy leakage between analyzer signal paths. This can be a problem with high-loss transmission measurements. Although the [crosstalk specification](#) of the VNA is exceptional, you can reduce the effects of crosstalk by doing the following:

- [Perform an Isolation Calibration](#)

Other topics about Optimizing Measurements

Perform an Isolation Calibration

For transmission measurements, a response and isolation measurement calibration helps reduce crosstalk because the analyzer measures and then subtracts the leakage signal during the measurement calibration. The calibration improves isolation so that it is limited only by the noise floor.

Note: Isolation is never performed on a Smart (Guided) Calibration. [Learn more.](#)

Generally, the isolation error falls below the noise floor. So when you are performing an isolation calibration you should use a noise reduction technique such as sweep averages or reducing the IF bandwidth.

Effects of Accessories

Accessories in a configuration may affect the results of a device measurement. You can choose between two analyzer features that reduce the effects of accessories.

- [Power Slope to Compensate for Cable Loss](#)
- [Gating to Selectively Remove Responses](#)

Other topics about Optimizing Measurements

Power Slope to Compensate for Cable Loss

If you have a long cable or other accessory in a measurement configuration where a power loss occurs over frequency, apply the power slope function. This function increases the analyzer source power by a rate that you define (dB/GHz).

1. Press **Power** > **Leveling & Offsets**.
2. If the slope function is not already switched on, click the button beside **Slope**.
3. In the **Slope** box, enter the rate that you want the source power to increase over the frequency sweep.

Gating to Selectively Remove Responses

Gating is a feature in the time domain (option 010) that allows the analyzer to mathematically remove responses. You can set the gate for either a reflection or transmission response, but you will see different results.

- **Gating a reflection response** isolates a desired response (such as a filter's return loss), from unwanted responses (such as adapter reflections or connector mismatches).
- **Gating a transmission response** isolates a specific path in a multipath device that has long electrical lengths.

See Time Domain Gating for more information.

Last modified:

29-Sep-2015 First Release

Achieve Fastest Sweep

You can achieve the fastest measurement sweep by adjusting the following:

- [Sweep Settings](#)
- [Noise Reduction Settings](#)
- [Measurement Calibration Choice](#)
- [Unnecessary Functions](#)

Other topics about Optimizing Measurements

Sweep Settings

Consider changing each of the following settings as suggested.

- [Frequency Span](#) - Measure only the frequencies that are necessary for your device.
- [Segment Sweep](#) - Use segments to focus test data only where you need it.
- [Switch Off Stepped Sweep](#) - Use linear swept mode to minimize sweep time when possible.
- [Auto Sweep Time](#) - Use this default to sweep as quickly as possible for the current settings.
- **Number of Points** - Use the minimum number of points required for the measurement.

Note: Sweep time may be longer in the following situations.

- * Sweep Time Entry is displayed.
- * Sweep Timing or Trigger SoftTab is displayed.

For more information on how number of points and other settings affect sweep cycle time, see [Technical Specifications](#).

Noise Reduction Settings

Using a combination of these settings, you can decrease the sweep time while still achieving an acceptable measurement.

- [IF Bandwidth](#). Use the widest IF bandwidth that will produce acceptable trace noise and [dynamic range](#).
- [Average](#). Reduce the average factor, or switch Average off.

Measurement Calibration Choice

Choose the appropriate type of calibration for the required level of accuracy.

When full 2-port error correction is applied, the VNA takes both forward and reverse sweeps to gather all 12 error correction terms. This occurs even with a single S11 measurement displayed. All displayed measurements are updated as the second sweep is performed. Both sweeps are performed using the specified sweep time.

When calibrating greater than 2 ports, the following formula is used to determine the number of sweeps required:

- $N * (N-1)$ where N = the number of ports.

When full 3-port calibration is applied, 6 sweeps are required; forward and reverse for each port pair. With full 4-port correction, 12 sweeps are required, and so forth.

To limit the measurement time, perform ONLY the level of calibration that your measurements require. For example, if making only an S11 measurement, perform a 1-port calibration on that port.

Sweep speed is about the same for uncorrected measurements and measurements done using a response calibration, or one-port calibration. For more information see [Select a Calibration](#).

Unnecessary Functions

The analyzer must update information for all active functions. To achieve an additional increase in sweep speed, switch off all of the analyzer functions that are not necessary for your measurement application.

- [Delete Unwanted Traces](#)
- [Switch Off Unwanted Markers](#)
- [Switch Off Smoothing](#)
- [Switch Off Limit Testing](#)
- [Switch Off Math Functions](#)

Analyzer sweep speed is dependent on various measurement settings. Experiment with the settings to get the fastest sweep and the measurement results that you need.

Last modified:

13-Aug-2014 First Release



Switch Between Multiple Measurements

If you need to make multiple measurements to characterize a device, you can use various methods to increase throughput. Experiment with these methods to find what is best for your measurement application needs.

- [Set Up Measurements for Increased Throughput](#)
 - [Arrange Measurements in Sets](#)
 - [Use Segment Sweep](#)
 - [Trigger Measurements Selectively](#)
- [Automate Changes Between Measurements](#)
- [Recall Measurements Quickly](#)

Other topics about Optimizing Measurements

Set Up Measurements for Increased Throughput

To achieve optimum throughput of devices that require multiple measurements, it is helpful to know the operation of the VNA. This knowledge allows you to set up the measurement scenarios that are best for your applications.

[Learn more about Traces, Channels, and Windows on the VNA](#)

Arrange Measurements in Sets

If you arrange measurements to keep the complete set of device measurements in one instrument state, you can save them so that you can later recall a number of measurements with one recall function.

See Pre-configured Measurement Setups for more information.

Use Segment Sweep

Segment sweep is helpful if you need to change the following settings to characterize a device under test.

- Frequency Range
- Power Level
- IF Bandwidth
- Number of Points
- Delay
- Sweep Mode
- LO Offset

The segment sweep allows you to define a set of frequency ranges that have independent attributes. This allows you to use one measurement sweep to measure a device that has varying characteristics.

See [Segment Sweep](#) for more information.

Trigger Measurements Selectively

You can use the measurement trigger to make measurements as follows:

- Continuously update only the measurements that have rapidly changing data.
- Occasionally update measurements that have infrequently changing data.

For example, if you had four channels set up as follows:

- Two channels measuring the data that is used to tune a filter
- Two channels measuring the data for the out-of-band responses of the filter

You would want to constantly monitor only the measurement data that you use for tuning the filter. If you continuously update all of the channels, this could slow the response of the analyzer so that you would not be able to tune the filter as effectively.

Note: You must either trigger the infrequent measurement manually or with remote interface commands.

To trigger measurements selectively:

This procedure shows you how to set up two different measurements with the following behavior:

- Channel 1 measurement will continuously update the data.
 - Channel 2 measurement will occasionally update the data.
1. Press **Setup > Quick Start**.
 2. At the **Quick Start** dialog box, click **Create in new channel**.
 3. **Frequency Sweep** dialog box shows. Enter the preferred sweep setting.

Set Up a Measurement Trigger for Continuous Updates

1. Press **Trigger > Trigger Source** and select **Internal**.
2. Press **Trigger > Trigger...**
3. At the **Trigger** dialog box under **Channel Trigger State**, select **Channel 1**, and click **Continuous**.

Set Up a Measurement Trigger for Occasional Updates

5. At the **Trigger** dialog box under **Channel Trigger State**, select **Channel 2**, and click **Single, OK**.
6. Press **Trigger > Restart**.

Update the Measurement

7. Click on the lower window to make Channel 2 the **active channel**.
8. On the active entry toolbar, click the type of trigger you set up.
 - Click **Single** if you set up the analyzer for a single sweep per trigger.
 - Click **Groups** if you set up the multiple sweeps per trigger.

Note: A trace must be active for you to initiate a trigger for that measurement.

Automate Changes Between Measurements

If there are slight differences between the various measurements that you need to characterize a device, you may find that it is faster to change the measurement settings using programming.

Recall Measurements Quickly

The most efficient way to recall measurements is to recall them as a set of measurements (instrument state).

- It only takes a short time longer to recall an instrument state that includes multiple measurements, than it does to recall an instrument state with only one measurement.

E5080A

- Each recall function has time associated with it. You can eliminate that time by setting up the measurements as a set so you can recall them as a set.

See [Save and Recall Files](#) for more information.

Last modified:

21-Aug-2014 First Release



Data Transfer Speed

When testing devices remotely using SCPI, the following techniques can be used to transfer data quickly between the VNA and remote computer, helping you achieve the best measurement throughput.

- Use [single sweep \(trigger\) mode](#) to ensure that a measurement is complete before starting a data transfer.
- **Transfer the minimum amount of data** needed. For example, a trace with a few points, using segment sweep rather than a full trace with many linearly spaced points. Also, use markers instead of trace transfers.
- **Choose the REAL data format** to provide the fastest transfer speed when using SCPI programs for automated applications.
- **Use SCPI over LAN** for applications that are automated with SCPI programs.
- **Use Shared Memory Data Transfer.** Learn how.

Other topics about Optimizing Measurements

Using Macros

Macros are executable programs that you write, load into the analyzer, and then run from the analyzer. You can have up to 25 macros set up to run on the analyzer.

- [How to Setup Macros](#)
- [How to Run Macros](#)
- [Macro Example](#)

How to Setup Macros

Using **Hardkey/SoftTab/Softkey**

1. Press **Macro** > **Key Setup** > **Macro Setup...**

In the Macro Setup dialog box:

1. Create an executable program and save it on the VNA hard drive. See SCPI example programs in VBscript.
2. Use a mouse or the front-panel 'down-arrow' to select a blank line below the last entry. (There may be NO entry.)
3. Click **Edit** to start the [Edit Macro Setup](#) dialog.
4. In the **Macro Title** box, type a descriptive title for your macro.
5. Click **Browse...**
6. Change **Files of Type**.
7. Find and select your executable file. Change **Files of Type** if necessary.
8. Click **OK** on the Edit Macro Setup dialog.
9. Click **OK** on the Macro Setup dialog.
10. Press **MACRO** to run. It may be necessary to first Preset the VNA to see your macro in the menu.

Macro Setup dialog box help

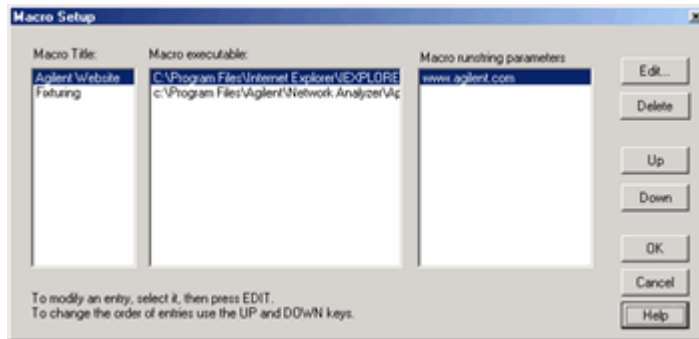

Macro setup allows you to create up to 25 macros that can be launched from the VNA application.

An external keyboard is required to enter the Macro Title and the Run string parameters.

To add a Macro, use a mouse or the front-panel 'down arrow' (NOT the 'Down' key) to select a blank line. Then click **Edit**.

Macro Title Shows the titles that appear in the softkeys and menu when you press the Macro key. These titles are associated with the executable files and should be descriptive so you can easily identify them.

Macro Executable Lists the complete path to the executable file. To follow the example of launching the Keysight VNA Series Home Page, the path to the executable could be "C:/Program Files/Internet Explorer/iexplore.exe".

Macro Runstring Parameters Lists the parameters that get passed to the program that is referenced in the executable file. Again following the example of launching the VNA Series Home Page, you could assign the runstring parameters "http://www.Keysight.com/find/pna".

Edit Invokes the [Macro Edit dialog box](#).

Delete Deletes the selected macro.

Up Allows you to reorder the macros, moving the selected macro up one line. This order determines how they appear in the VNA Menu and in the softkeys and when you press the Macro front-panel key.

Down Moves the selection down one line in the list of macros.

Macro Edit dialog box help

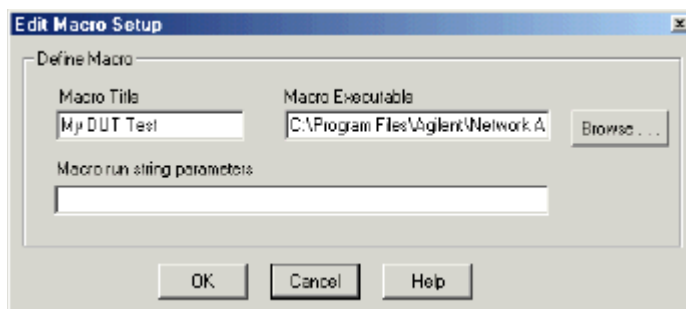

Macro Title Add a title that appears in the softkeys and menu.

Macro Executable Set the complete path to the macro executable file. Click **Browse** to navigate to the macro executable file and establish the complete path to the file.

Macro run string parameters Optionally add parameters that are passed to the program referenced

in the executable file.

[See Macro Setup dialog box](#)

How to Run Macros

Using **Hardkey/SoftTab/Softkey**

1. Press **Macro** > **Macro<#>**
2. then select the macro to run

Macro Example

The following is an example Visual Basic Scripting (vbs) program that you can copy, install, and run on your VNA.

Note: Print these instructions if viewing in the analyzer. This topic will be covered by the Macro Setup dialog box.

1. Copy the following code into a Notepad file.
2. Save the file on the analyzer hard drive in the **C:/Documents** folder. Name the file **FilterTest.vbs**
3. Close Notepad
4. [Setup the macro in the VNA](#)
5. [Run the macro](#)

Notepad is a text editor that is installed on all PCs that use a Microsoft Operating system. To launch Notepad on the analyzer:

1. Click **View**, then click **Title Bars**
2. Click the **Start** button on the windows taskbar
3. Point to **Programs, Accessories**.
4. Click **Notepad**

```
'Start copying here
'This program creates a S21 measurement
'It is written in VBscript using SCPI commands

Dim app
Dim scpi
'Create / Get the VNA application
Set app = CreateObject ("AgilentPNA835x.Application")
Set scpi = app.ScpiStringParser

'Preset the Analyzer.FPReset presets the setting and deletes all traces and
windows
scpi.Execute ("SYST:FPReset")
'Create and turn on window 1
scpi.Execute ("DISPlay:WINDow1:STATE ON")
'Define a measurement name, parameter
scpi.Execute ("CALCulate:PARAMeter:DEFine:EXT 'MyMeas', 's21'")
'Associate ("FEED") the measurement name ('MyMeas') to WINDOW (1), and give
the new TRACE a number (1).
scpi.Execute ("DISPlay:WINDow1:TRACe1:FEED 'MyMeas'")
```

'End copying here

Last Modified:

2-Sep-2014 First Release



3. Calibrate a Measurement

Select a Calibration Type

The following calibration types are available in the VNA.

Cal Type	Accuracy	Thru Methods allowed
TRL Family	Very High	All except Unknown Thru
SOLT	High	All
Enhanced Response	High	Defined Thru or Flush Thru
QSOLT (Quick SOLT)	Medium	Defined Thru or Flush Thru
1-Port Reflection	High	Not Applicable
Open/Short Response	Low	Not Applicable
Thru Response	Low	Known Thru or Flush Thru

Learn how to select a default Cal Type.

Other Cal Types (Separate Topic)

- [Source and Receiver Power Cals](#)

See other Calibration Topics

TRL Family

Application: Used to accurately calibrate any pair of ports when calibration standards are not readily available.

Note: A Delta Match Cal may be required.

- [Learn more about TRL family cal](#)
- For more information on modifying standards, see [Calibration Standards](#).

General Accuracy: Very High

Standards Required: THRU, REFLECT, LINE or similar combination

Systematic Errors Corrected:

- Directivity
- Source match
- Isolation ([see exceptions](#))
- Load match
- Frequency response transmission tracking
- Frequency response reflection tracking

SOLT

Application: Used to accurately calibrate any number of ports.

General Accuracy: High

Standards Required: (SHORT, OPEN, LOAD, THRU) or ECal module

Systematic Errors Corrected (on all ports):

- Directivity
 - Source match
 - Isolation ([see exceptions](#))
 - Load match
 - Frequency response transmission tracking
 - Frequency response reflection tracking
-

Enhanced Response

Application: Used to calibrate two ports when only measurements in one direction (forward OR reverse) are required. Measurements are faster because a second sweep is NOT required.

- Reflection Standards (OPEN, SHORT, LOAD) are connected to the source port to be calibrated.
- [Defined THRU](#) or [Flush THRU](#) standard is connected between port pairs.
- Much quicker than SOLT when using a mechanical cal kit. ECal can also be used.

To select Enhanced Response:

For a standard S-parameter Cal, select **Cal** > **Main** > **Basic Cal...**

Then, In the **Basic Cal** dialog box:

1. Under 'Cal Type', select **Enh Response 1-> 2 Enh** or **Response 2-> 1**.
-

General Accuracy: High

Standards Required: (SHORT, OPEN, LOAD, [Defined THRU](#) or [Flush THRU](#))

Systematic Errors Corrected:

- Directivity (source port)
 - Source match (source port)
 - Isolation ([see exceptions](#))
 - Load match (receiver port) - used only to produce transmission tracking term.
 - Frequency response transmission tracking (receiver port).
 - Frequency response reflection tracking (source port).
-

QSOLT (Quick SOLT)

Application: Used to quickly calibrate any number of ports. Developed specifically for use with external multiport test sets.

Note: A Delta Match Cal is required to cal test ports that do not have a dedicated reference receiver.

- Reflection Standards (OPEN, SHORT, LOAD) are connected to only ONE of the ports to be calibrated. The lower port number of the ports to be calibrated is selected by default. This can be changed through the [Modify Cal / Cal Type](#) setting.
 - [Defined THRU](#) or [Flush THRU](#) standards are connected from the reflection standard port to the remaining ports to be calibrated.
 - Much quicker than SOLT when using a mechanical cal kit.
 - Based on TRL math.
-

General Accuracy: Not as high as SOLT

Standards Required: (SHORT, OPEN, LOAD, [Defined THRU](#) or [Flush THRU](#))

Systematic Errors Corrected:

- Directivity
 - Source match
 - Isolation ([see exceptions](#))
 - Load match
 - Frequency response transmission tracking
 - Frequency response reflection tracking
-

1-Port (Reflection)

Application: Used to accurately calibrate any single test port for reflection measurements only.

General Accuracy: High

Standards Required: (SHORT, OPEN, LOAD) or ECal module

Systematic Errors Corrected:

- Directivity
 - Source match
 - Frequency response reflection tracking
-

Open / Short Response

Application: Used to quickly calibrate any single test port for reflection measurements only.

General Accuracy: Low

Standards Required: OPEN or SHORT

Systematic Errors Corrected:

Frequency response reflection tracking

Thru / Transmission Response (Isolation Optional)

Application: Used to quickly calibrate any pair of test ports for transmission measurements only.

Isolation is not usually recommended. Learn more about [Isolation](#)

General Accuracy: Low

Standards Required: THRU

Isolation: One LOAD for each VNA test port.

Systematic Errors Corrected:

- Frequency response transmission tracking
 - Isolation
-

Last modified:

18-Aug-2014 First Release



Calibration Wizard

The Calibration Wizard allows you to choose a Calibration method and then perform the calibration.

- [How to Start Calibration Wizard](#)
- [SmartCal \(Guided Calibration\)](#)
- [Basic Calibration](#)
- [Saving a Calibration](#)

Other Cal Topics

How to start Calibration Wizard

Using **Hardkey/SoftTab/Softkey**

1. Press **Cal** > **Other Cals** > **Smart Cal...**

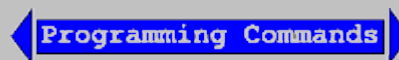

The Calibration Window / Channel

During a Guided Calibration, a 'Cal Window' is created for you to view the connection of calibration standards before standards are measured. This Cal Window uses a new Cal channel that is created and duplicates the settings in the channel being calibrated. [Correction is ALWAYS OFF](#) for the displayed calibration channel. At the completion of the calibration, the calibration channel and window are deleted.

The measurement of calibration standards can be performed while viewing any VNA window configuration you choose. The Cal Window is appended to your Custom Cal Window setting, and all windows are visible and sweeping below the Cal Wizard before the Measure (cal standard) button is pressed. The windows to be viewed and channels to be swept during the cal process are specified using Remote commands.

The Cal Window settings do not work in a FCA channel.

SmartCal (Guided Calibration)

A Guided Calibration automatically determines the calibration type and suggests a calibration kit that matches your DUT connectors. Guided Calibration can perform the following Cal Types:

- ALL Cals **EXCEPT Open, Short, and Thru Response Cals**.
- ECal on one or more ports.
- TRL - [Learn how to do TRL cals](#)

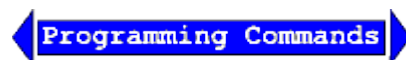

Note: SmartCal DOES allow you to measure calibration standards in any order. However, you must click **Next** and **Back** without measuring standards until you get to the standard you want to measure.

The VNA displays the following dialog boxes when performing a Guided calibration on standard channels. To learn about Calibrations for Application channels, refer to the help topic for the Application.

Select Ports for Guided Calibration dialog box help

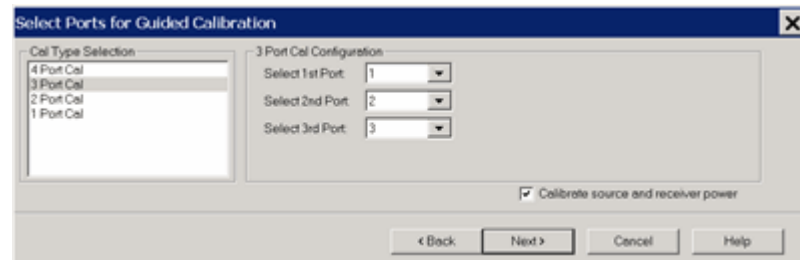

Allows you to select ports to calibrate.

Cal Type Selection Select the number of ports to calibrate.

N Port Cal Configuration If not calibrating all VNA ports, specify which ports to calibrate.

Calibrate source and receiver power Check to perform a Guided Power Calibration. [Learn more.](#)

See Also: [Use Multiple Power Sensors to perform a Guided Power Cal](#)

Back Return to [Cal Wizard Begin](#) dialog. If you did not see the 'Cal Wizard Begin' dialog but want to, click **Back**, then clear the [Save Preferences](#) checkbox.

For greater than 4-port cals, see External Test Set calibration - Select Cal Type.

Select DUT Connectors and Cal Kits dialog box help

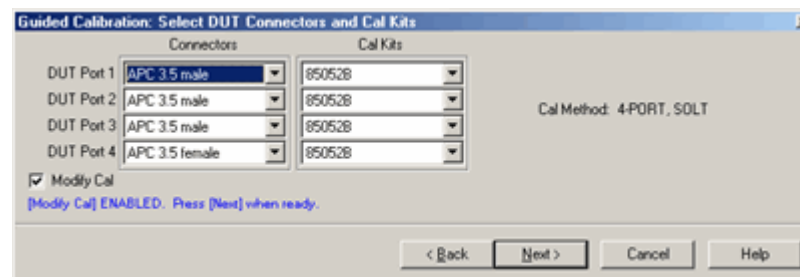

Allows you to select the connector type and Cal Kit for each DUT port to be calibrated.

Connectors To change selection, click the connector field for each DUT port.

If your DUT connectors are **not listed**, you can create your own connector type and calibration kit file. The VNA includes the following example cal kits that can be used as a template. See [Calibration kits](#) for more information.

- If using a gendered (male and female) connector type, select **Type A** as the connector type.
- If using a connectorless device such as on-wafer probes., select **Type B** as the connector type.

Cal Kits Select the Cal Kit to be used to calibrate each test port. The list for each DUT Port displays kits having the same connector type as the DUT.

Identical ECal models connected? ECal modules can be distinguished by serial number. This can have implications on your remote [SCPI](#) programs.

Cal Kit Notes**85056K**

The 85056K definitions in the VNA are for 2.92mm standards (2.4mm plus 2.92 adapters). To calibrate 2.4 mm connectors using the 85056K cal kit, select 85056A as the cal kit when you need the sliding load. Otherwise, select 85056D as the cal kit. Both the 85056A and the 85056D kits contains exactly the same standards as the 85056K cal kit WITHOUT the adapters.

TRL

- To perform a [TRL Cal](#), assign a TRL Cal Kit to the lowest port number of each port pair.
- When selecting a TRL Cal Kit on a PNA-L model that requires a Delta Match Cal, and a Global Delta Match Cal is not available, the Cal type will be set to SOLT and a "Could not find a Global Delta Match Cal." message is displayed on the dialog box. If the selected Cal Kit will not support SOLT, the **Next** button will not be available. Then you must select a different Cal Kit to proceed or **Cancel** and perform a Global Delta Match Cal.

Modify Cal Check, then click Next, to [Modify Cal](#) (Standards AND Thru Method).

For greater than 4-port cals, see External Test Set calibration - Select DUT Connectors.

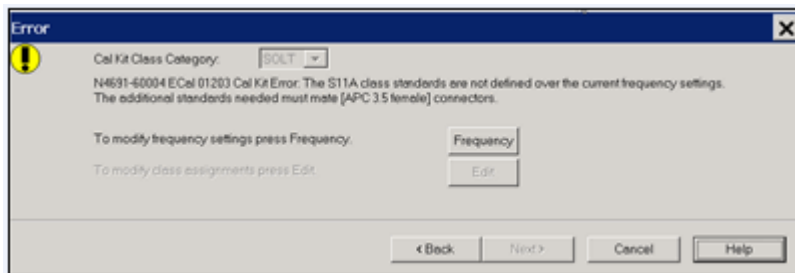
Error dialog box help

The current cal kit does not cover the current frequency range of the measurement. Do one of the following to correct the problem:

Cal Kit Class Category Choose from SOLT and TRL. Not available with ECal modules. Click **Edit** to modify the appropriate class assignments.

Frequency Change the frequency range of the active channel.

Edit Modify the class assignments so that a different standard is selected.

Back Select a different Cal Kit that covers the required frequency range.

Cancel Exit the Cal Wizard

Modify Cal dialog box help

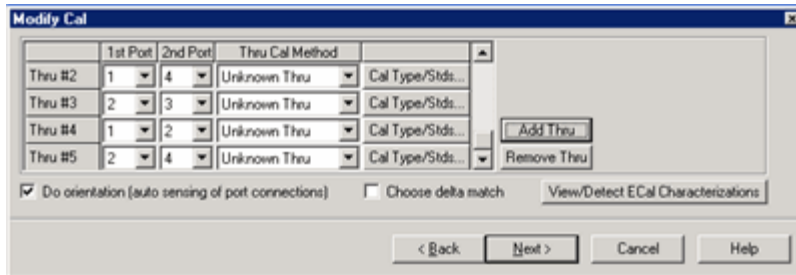

Thru #n

Lists the proposed Thru connections to be made during the calibration process. You can change these Thru connections to better suit your test setup.

- The proposed Thru connections are listed automatically.
- Additional Thru connections can be selected for higher accuracy. [Learn more](#).

Add Thru

Click to add a Thru connection. [Learn more](#)

Remove Thru

Select a Thru by clicking the "Thru #N" field or the "1st Port / 2nd Port" field. Then click "Remove Thru". This selection is NOT available if the selected Thru is required for the calibration.

1st Port / 2nd Port

Click to select the two ports to be included in the Thru connection. The order of the port numbers is not critical.

Thru Cal Method

Lists the available Thru Cal methods for the specified port pairs.

[Learn about the Thru Cal Method choices.](#)

Cal Type/ Stds

Click to invoke the [View / Modify Properties of Cal dialog box](#)

Do orientation - Appears ONLY if an ECal module is selected for use.

When this box is checked (default) the VNA automatically senses the model and direction in which an ECal module port is connected to the VNA ports. If power to the ECal module is too low, it will appear as if there is no ECal module connected. If you use low power and are having this problem, clear this check box to provide the orientation manually.

Orientation occurs first at the middle of the frequency range that you are calibrating. If a signal is not detected, it tries again at the lowest frequency in the range.

Choose delta match - Available when a Delta Match Cal is required.

- Check, then click **Next** to invoke the [Select Cal Set for Delta Match](#) dialog box.
- Clear - The Cal Wizard uses the Global Delta Match Cal if available.

View/Detect ECal Characterizations - Appears ONLY if an ECal module is selected for use.

Click to invoke the [View ECal Modules and Characterizations](#) dialog box. Displays a list of ECal modules that are connected to the VNA.

View/Modify Properties of Cal for Ports... dialog box help

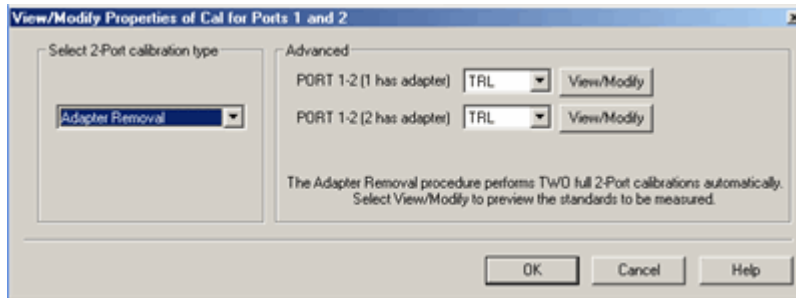

Select calibration type

Another chance to change the Thru method.

[Learn about the Thru Cal Method choices.](#)

Advanced

Select the cal method for each connector of the Thru pair.

- [TRL](#) - Available ONLY when a TRL cal kit was selected for the lowest port number of the port pair.
- [QSOLT](#) Available ONLY when "Defined Thru" or "Flush Thru" is selected. "**QSOLT 2 <= 1**" refers to the receive port 2 and source port 1 (where reflection standards are connected).
- [Enhanced Response](#) Available ONLY when "Defined Thru" or "Flush Thru" is selected. "**EnhResp 2 <= 1**" refers to the receive port 2 and source port 1.
- [Transmission Response](#) Available ONLY when "Defined Thru" or "Flush Thru" is selected, when Mechanical Cal is selected, and when 2 ports are being calibrated. "**TransResp 2 <= 1**" refers to the receive port 2 and source port 1.

View Modify Click to invoke the [Preview and Modify Calibration Selections](#) dialog box.

Note: Changes made to the Cal Kit through this dialog are **temporary** that last only for this calibration. To make permanent changes to the Cal Kit, perform [Advanced Modify Cal Kits](#).

Select Cal Set for Delta Match dialog box help

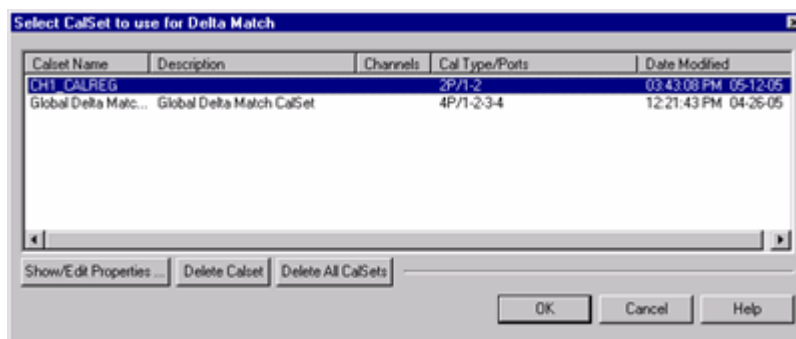

This dialog box appears when a Delta Match Cal is required and [Choose delta match](#) was selected. Learn more.

Displays the Cal Sets that meet the requirements of the Delta Match Cal.

Select either a User Cal Set or Global Delta Match Cal.

If there is no suitable choice for a Delta Match Cal:

1. Click **Cancel**, then **Cancel** again to quit the Cal Wizard.

2. Perform either a Global Delta Match Cal or a SOLT cal and save the result in a User Cal Set.
3. Start the Cal Wizard to re-initiate this calibration.
4. Select the Global Delta Match Cal or User Cal Set.

Calibration Steps dialog box help

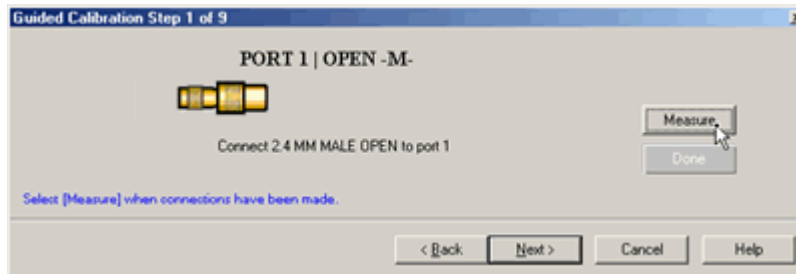

Note: Beginning in VNA Rev. 6.0, calibration can be performed with External triggers. [Learn more.](#)

As each new cal step prompt appears, the traces are setup for the next standard measurement. Also, sweeps are triggered continuously until the Measure button is pressed. This way you can view the integrity of the standard connection.

Prompts for standards to be measured.

Measure Click to measure the standard.

Done Click **after** a standard is re-measured and all measurements for the calibration are complete.

Next Click to continue to the next calibration step. Does **NOT** measure the standard.

If a standard is NOT measured, a warning appears and **Done** will not be available after the last Cal step.

Note: Smart (Guided) Cal allows you to measure calibration standards in any order. However, you must click **Next** and **Back** without measuring standards until you get to the standard you want to measure.

Sliding Load Measurement dialog box help

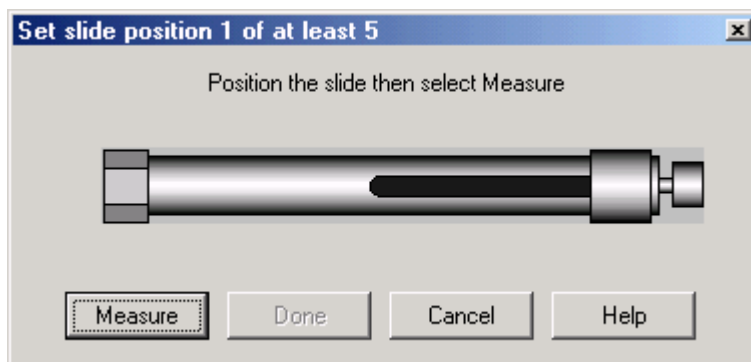

Allows you to measure the sliding load standard.

To ensure an accurate calibration, carefully follow the instructions that were provided with your sliding load.

To Measure a Sliding Load:

1. Connect the sliding load to the measurement port.
2. Position the sliding element, then click **Measure**. Do not move the sliding element until measurement is complete.
3. Measure the sliding load for at least **five** and up to **seven** positions for best accuracy.

Note: The positions of the sliding element should cover the full length of the slide, but be unequally spaced to reduce the possibility of overlapping data points. Most sliding loads have marks for each slide position.

4. Click **Done** after the final measurement.
5. Remove sliding load from the measurement port.
6. Measure the remaining standards.

Specify delay dialog box help

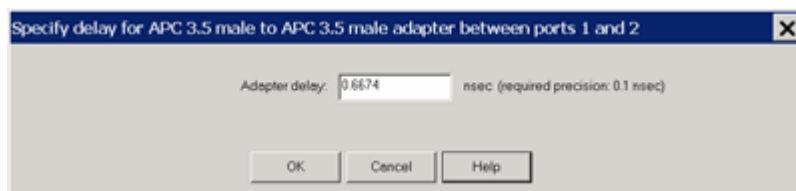

This dialog appears ONLY when [Adapter Removal](#) or [Unknown Thru](#) calibrations are performed.

The following values were estimated from the measurement. Most of the time, they are adequate. However, for CW sweep or frequency sweep with large step sizes, the accuracy of the values may be improved.

Adapter delay To improve this value, measure and record the delay of the adapter with a dense step size. Enter that value here. The required precision value is the accuracy that is required to characterize the delay value.

Nominal phase offset (Waveguide ONLY). To improve this value, measure and record the phase offset of the Waveguide adapter with dense step size. Enter that value here.

When one connector is coax and the other connector is waveguide, the phase offset has an ambiguity of 180 degrees. For consistency, the estimate provided here is always between 0 and 180 degrees. You can change this estimate to any value between -180 degrees and +180 degrees.

The [Calibration Complete](#) dialog box appears after all standards are measured.

Basic Calibration

Using **Hardkey/SoftTab/Softkey**

1. Press **Cal** > **Main** > **Basic Cal...**

◀ **Programming Commands** ▶

It provides basic calibration. The limitations of basic calibration are, it is for:

- one connector type
- one cal kit
- one cal type
- no isolation cal
- no power calibration

Basic Cal dialog box help

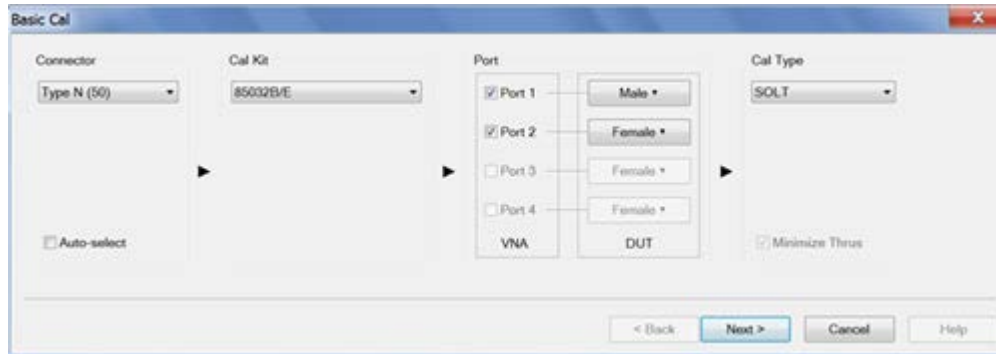

N

Connector Type Allows user to select single connector type.

Cal Kit Allows users to select single Cal Kit. The displayed selection options are according to the selected connector type.

Port Allows users to select the port gender. *No Connect* indicates that no port is connected to the VNA.

Cal Type Allows users to select calibration type. The displayed selection options are according to the selected cal kit, connector type and gender.

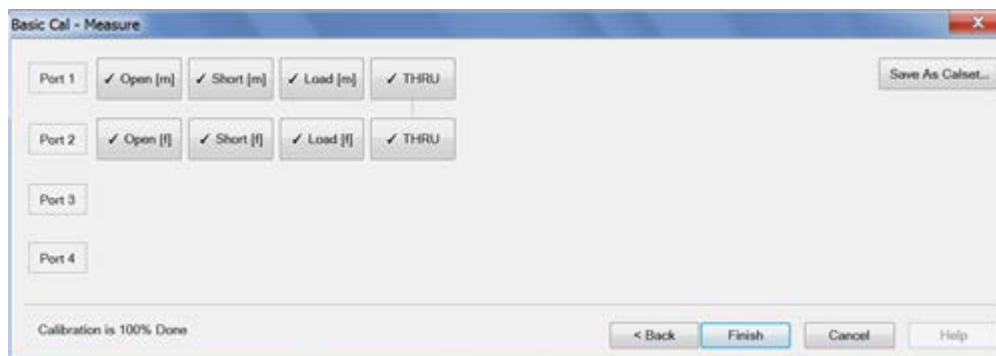

Save As Calset... Its grayed out when calibration is incomplete. Once the calibration is completed, press this button to save the calibration.

Saving a Calibration

SmartCal, ECal, and Unguided Calibrations end with the following dialog box:

Calibration Completed dialog box help

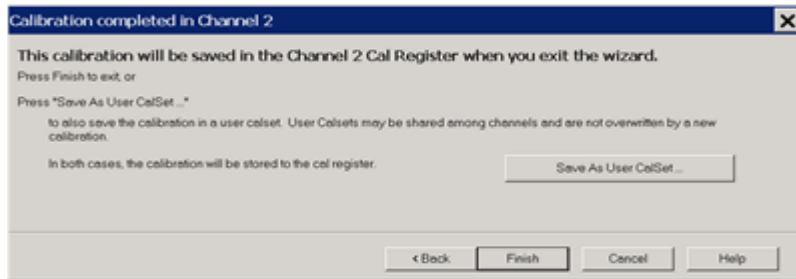

Finish Save to the channel's calibration register.

Save As User Cal Set Invokes the [Save as User Cal Set dialog box](#) AND save to the channel's calibration register.

Cancel Calibration is NOT applied or saved.

Learn about [Calibration Registers](#).

Learn about [User Cal Sets](#)

Save as User Cal Set dialog box help

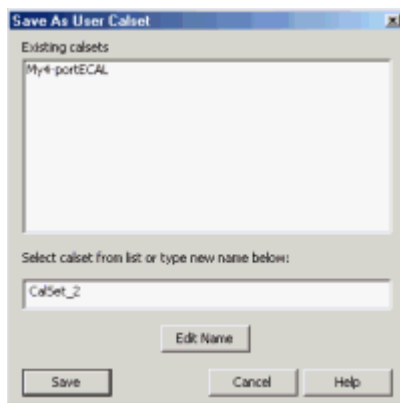

Existing Cal Sets - Lists the Cal Set names saved on the VNA.

Select Cal Set from list or type new name below Specify a name for the new Cal Set. Either accept the suggested new name, type a new name, or select a name from the list to overwrite an existing name.

Edit Name If there is no keyboard, click to start the VNA typing tool that can be used from the VNA front panel.

Save Saves the Cal Set to the new Cal Set name.

Learn about [User Cal Sets](#)

Last modified:

14-Aug-2014 First Release



Guided Power Calibration

Source and Receiver Power Calibration can be performed during a standard S-parameter Guided Calibration. This power cal provides the following enhancements over the standard source and receiver power calibration:

- A source and receiver power cal can be performed for all VNA ports with a single power sensor connection.
- [Multiple power sensors](#) can be used to cover wide frequency ranges.
- The receivers are corrected automatically.
- Optionally compensates for an adapter that may be used to connect the power sensor.
- Provides [optional match-corrected power measurements](#).
- Source and Receiver power correction is stored to the Cal Set along with S-parameter correction.

Note: A Guided Power Calibration is not accurate when Frequency Offset Mode is enabled.

Learn more about the standard [Source](#) and [Receiver](#) Power Cals.

How to perform a Guided Power Cal

1. In a [Standard \(S-parameter\)](#) channel, setup your measurements (sweep type, frequency range, IFBW, and so forth). A special version of this feature is available on mmWave SMC measurements. Learn more.
2. Connect the Power Meter / Sensor the same as a standard Source Power Cal. [Learn more.](#)
 - See [Supported Power Meters](#)
 - See Important first-time USB connection note.
3. Start the **Cal Wizard**, then select **Guided (Smart) Cal**. [Learn how.](#)

◀ Programming Commands ▶

On the following **Select Ports** dialog, check **Calibrate source and receiver power**, then click **Next**.

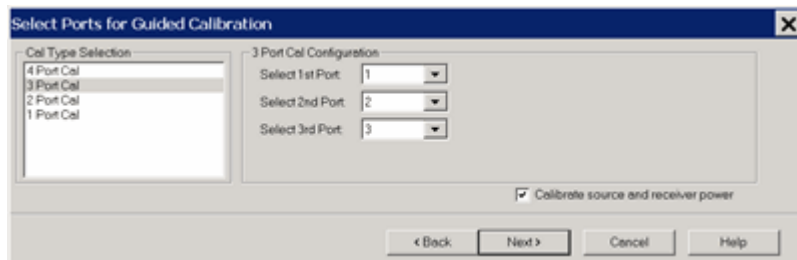

Two Cal Wizard pages later, complete the following dialog.

Power Cal Settings dialog box help



Note: A **Use Power Table** checkbox (not shown) is available when a mmWave SMC measurement is active. Learn more.

Power Cal at: Select the source port for which a Power Calibration will be performed. The source and receiver correction will be transferred to all other sources and receivers involved in the S-parameter measurements.

Use Multiple Sensors NOT available with SMC measurements.

Check this box to use one or more power sensors that are [configured as PMAR devices](#). This dialog is replaced with the [Multiple Sensors](#) dialog. See following image.

When "Use Multiple Sensors" is cleared (default setting), click [Power Meter Settings](#) to configure the power meter.

De-embed (power sensor) adapter When the power sensor connector is NOT the same type and gender as the DUT connector for the specified port, then for optimum accuracy, extra cal steps are required to measure and correct for the adapter that is used to connect the power sensor to the reference plane.

Clear this box to NOT compensate for the added adapter.

Check this box to perform extra calibration steps to measure and correct for the adapter.

Then select the **Power Sensor Connector** type and gender of the power sensor. "Ignored" does NOT compensate for the added adapter, just as if the checkbox were cleared.

When this connector matches the DUT connector for the same port, then the VNA assumes that there is no adapter. Extra cal steps are NOT required and the Cal Kit selection is not available.

Otherwise, select the **Cal Kit** to be used to calibrate at the adapter.

See [Accuracy Settings](#) below.

Power Cal Settings - Use Multiple Sensors dialog box help

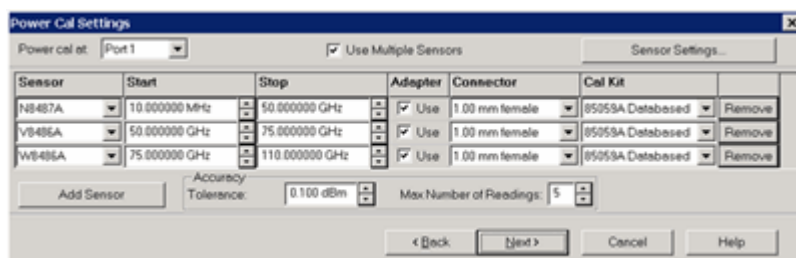

Notes

"Multiple sensors" are allowed ONLY on standard channels and during a [Cal All calibration](#).

The power sensors that are used as "multiple sensors" MUST be configured [PMAR devices](#).

Power Cal at: Select the source port for which a Power Calibration will be performed. The source and

receiver correction will be transferred to all other sources and receivers involved in the S-parameter measurements.

Sensor Settings Click to start the Sensor Settings dialog, used to [ADD / Configure an External Device](#).

Sensor Grid

Sensor Select the power sensor and the associated **Start** and **Stop** frequency range.

Adapter When the power sensor connector is NOT the same type and gender as the DUT connector for the specified port, then for optimum accuracy, extra cal steps are required to measure and correct for the adapter that is used to connect the power sensor to the reference plane.

Clear this box to NOT compensate for the added adapter.

Check this box to perform extra calibration steps to measure and correct for the adapter. Then specify the **Power Sensor Connector** type and gender of the power sensor. When this connector matches the DUT connector for the same port, then extra cal steps are NOT required, and the Cal Kit selection is not available. Otherwise, select the **Cal Kit** to be used to calibrate at the adapter.

Remove Click to remove the power sensor from the list.

Add Sensor Click to add a new line, then click the down-arrow to select a sensor. If a power sensor does NOT appear in the list, click the **Sensor Settings** button to configure a power sensor.

Accuracy

Tolerance When consecutive power sensor readings are within this value of each other, then the reading is considered settled.

Max Number of Readings Sets the maximum number of readings the power sensor will take to achieve settling. Each power reading is "settled" when either:

- Two consecutive readings are within this **Tolerance** value or
- When the **Max Number of Readings** has been met.

The readings that were taken are averaged together to become the "settled" reading.

Programming Commands

Power Sensor Connection step dialog box help

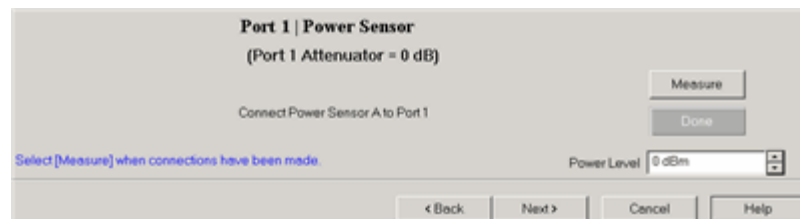

Power Level Set the power level at which the Source Power Cal is to be performed.

It is usually best to perform the Source Power Cal at 0 dBm because the power sensor is calibrated at that level. If 0 dBm is not achievable for your measurement, then set to the power level with the lowest level of measurement noise.

Turn OFF Match Correction

During a Guided Power Cal, the match between the power sensor and the VNA source port is measured. The source power correction array is compensated to account for the measured mismatch. In addition, the reference receiver measurement is also compensated to account for the mismatch of the DUT.

How to turn OFF match correction:

Click **Main**, then **Correction Methods**.

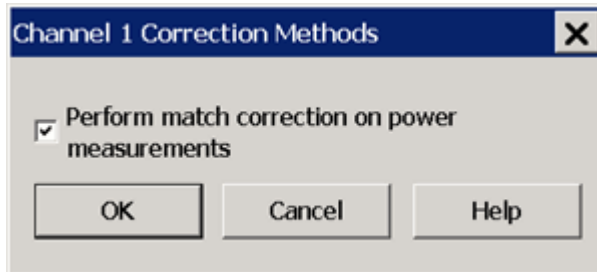
Correction Methods dialog box help

By default, the Guided Power Cal applies match correction to the receiver measurements. However, you may want to turn OFF match correction in the following cases:

- When making non-traditional measurements, such as high-power or multipoint configurations. Because of added components or reconfigurations, the mismatch measurement may not be valid.
- When you have a remote program that already accounts for the match effects of the sensor.

Clear the box to NOT apply match correction on all receivers used on this channel. The receivers are still corrected using standard receiver calibration. [Learn more](#).

Check the box to apply match correction on all receivers used on this channel.

Last Modified:

18-Nov-2014 Initial Release

Calibrate All Channels

"Cal All" allows you to calibrate multiple channels in a single calibration session. This not only reduces the number of connections that need to be made, but also the number of cal standard measurements that must be performed.

In this topic:

- [Features](#)
- [Limitations](#)
- [How to perform a Cal All Channels Calibration](#)
 - [Select Channels dialog](#)
 - [Measurement Class Cal Properties dialog](#)
 - [Calibration Attenuator Settings dialog](#)
 - [Select DUT Connectors and Cal Kits dialog](#)
 - [Power Cal Settings dialog](#)
 - [Cal Steps dialog](#)
 - [Finish](#)

Other Cal Topics

Features

Cal All offers a single, optimized calibration procedure for all channels (with some limitations, see below). The optimizations include:

- Minimizing the number of physical connection of standards.
- Minimizing the number of power meter calibration sweeps.
- User-settable power levels for S-Parameter as well as power calibration steps.
- Accounting for different switch and attenuator settings among different channels. This reduces the number of measurements required to characterize different switch/attenuator settings (channel setup differences).
- Cal All will produce the same number and format of Cal Sets (error terms) that would be realized had the calibrations been performed one at a time.

Limitations

- SMC+ Phase with phase enabled is supported using a known delay mixer or a phase reference cal set. S2P file characterized mixers are NOT supported.
- Starting the VNA in Multiport mode is NOT supported.
- Cal All is performed at one IFBW.
- All channels that are calibrated are forced into [stepped sweep mode](#).

- All channels to be calibrated MUST have the same [cal reference plane](#). In other words, Cal All cannot compensate for any path changes that occur external to the VNA.

How to perform a Cal All Channels Calibration

Using **Hardkey/SoftTab/Softkey**

- Press **Cal** > **Call All...**

◀ **Programming Commands** ▶

Selected Channels dialog box help

- Check the channels to be calibrated.
- Check the ports to be calibrated.
- Click **Next>**

Note: To perform an LO power cal for a mixer channel, set the LO port to a VNA or external source in the Mixer Setup dialog. Then select that port in this dialog.

Measurement Class Cal Properties dialog box help

Confirm or change the following unique cal properties for each channel to be calibrated. Click a link to learn about these properties.

The properties with **(NOT available in Cal All)** are NOT available in a Cal All calibration as they are in a stand-alone calibration.

SMC (VMC is NOT offered)

	Programming
--	--------------------

UI Setting	Property	Value
Enable Phase Correction	"Enable Phase Correction"	"true" or "false"
Phase Correction Method	"Phase Correction Method"	"Use Mixer Delay" "Use Receiver Characterization Calset"
Mixer Delay	"Mixer Delay"	Real number indicating delay value.
Receiver Characterization Cal Set	"Calset"	String of Cal Set Name
Characterized mixer (s2p file) (NOT available in Cal All)		

Standard Channel

Programming		
UI Setting	Property	Value
Include Power Calibration	"Include Power Calibration"	"true" or "false"

The power cal is optional only if none of the selected channels require a power cal.

Calibration Attenuator Settings dialog box help

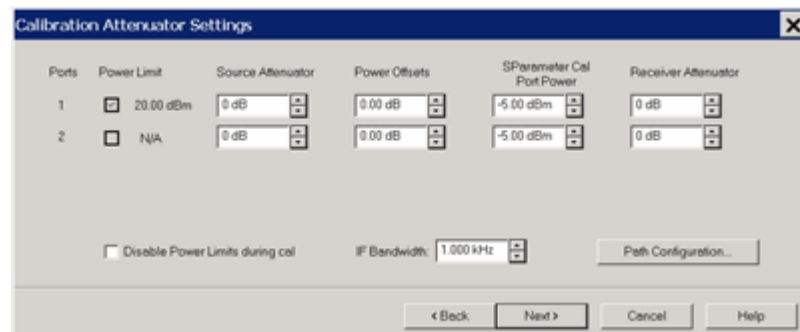

This dialog shows the Power, Attenuator, and IFBW settings for the Cal All calibration. The default values for the Cal All session are the preset values of a standard S-parameter channel. These values are not necessarily the same as those of the channels that are selected for calibration. When there are differences in measurement path (switch) settings between the Cal All channel and the selected channels, these differences are detected by Cal All and additional measurements are made for each path condition. These additional measurements allow Cal All to produce error terms appropriate for each of the selected channels. In general, the Cal All session should be performed at a power level that is high enough to prevent noise in the error terms. However, an increase in power could cause compression or damage to the VNA receivers. The following settings allow you to increase the power level ONLY during the Cal All session.

Power Limit (Disable)

Cal All shows you when power limits are enabled. This setting provides you a convenient way to

TEMPORARILY disable these limits in order to take advantage of the power settings available in Cal All. If power limits are on, your DUT is probably a high-gain device and the attenuator settings in your channels are high resulting in lower power at the cal reference plane. This lower signal can result in noisier measurements during the acquisition of cal. This situation is precisely what Cal All is intended to improve. Cal All allows you to configure the calibration conditions for better signal-to-noise performance during the cal while leaving your DUT conditions alone. You can elect to clear the “Disable Power Limits during cal” checkbox when you prefer to calibrate at a higher power level than is allowed by your limit. The limit is restored after the Cal All session.

Source / Receiver Attenuator

By default, the Cal All calibration is performed with Source and Receiver attenuators set to 0. Change the Source or Receiver attenuator settings when external hardware (such as a booster amplifier) would cause the VNA receivers to be compressed or damaged.

You may also want to change the attenuator or path configuration settings to force the cal channel to match settings of the selected channels. If all of the selected channels are set to identical hardware settings, it may be better to apply these settings to the cal channel. For example, if your channels all use a 5 or 10 dB attenuator step at port 1, you might elect to change the Cal All channel to use the same low attenuator settings. This will result in the cal measurements being made under the same path conditions as the channel and it will eliminate the need to mathematically compensate for the difference. However, if large attenuator values are used, the default Cal All settings will likely improve your results.

S-Parameter Cal Port Power

Set the power level at which the S-Parameter cal is performed.

Power Offsets

Power Offsets are channel-scoped. Consequently, offsets that you already set are NOT automatically copied to the Cal All session. This setting allows you to also apply a Power Offset during the Cal All session. [Learn about Power Offsets.](#)

IF Bandwidth

Set the IFBW used to perform the Cal All calibration. The default IFBW setting of 1 kHz is a good nominal setting for most measurements. Lowering the IFBW removes noise from the calibration measurement, but also causes slower sweeps.

Path Configuration

In addition to application-specific calibration requirements, Cal All performs an S-parameter calibration + power cal on behalf of all the selected channels. By default, this calibration is performed with standard channel default hardware paths:

- Bypass switches are set to “Thru”
- Noise switches are set to Normal.

Path configuration differences between your channel and the Cal All channel are mathematically removed.

The Path Configuration dialog allows you to change the path settings for this portion of Cal All calibration.

Select DUT Connectors and Cal Kits dialog box help

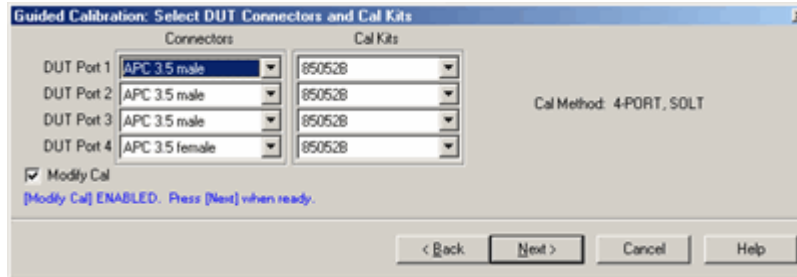

For each DUT port:

- Select the connector at the calibration reference plane (where the cal standards will be connected).
- Select the cal kit to be used.

Check **Modify Cal** to change the Thru method. An Unknown Thru cal is performed by default. [Learn about THRU methods.](#)

[Learn more about this dialog.](#)

Power Cal Settings dialog box help

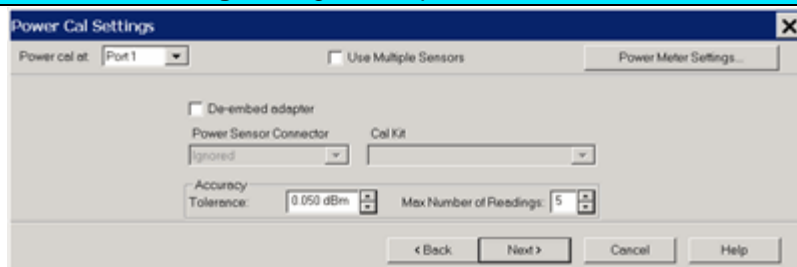

A guided power cal is performed on the source ports for the Cal All calibration.

This dialog is displayed for each source port to receive a power cal.

To perform an LO power cal for a mixer channel, set the LO port to a VNA or external source in the Mixer Setup dialog. Then select that port in the [Selected Channels dialog](#).

- To use the **same** power sensor for all power cals, do **NOT** check Use Multiple Sensors.
- To use **different** power sensors, check **Use Multiple Sensors**. The sensor must be configured as a PMAR device. [Learn how.](#)

[Learn about this dialog box.](#)

Cal All Summary dialog box help

3. Calibrate a Measurement

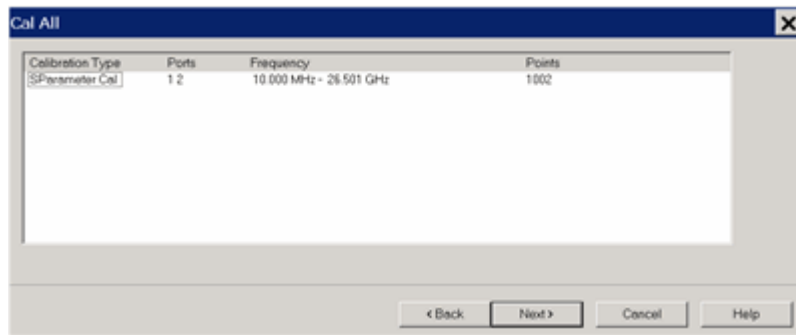

This page is a summary of the Cal All settings. Confirm the settings, then click **Next >** or **< Back** to change settings.

Cal Steps dialog box help

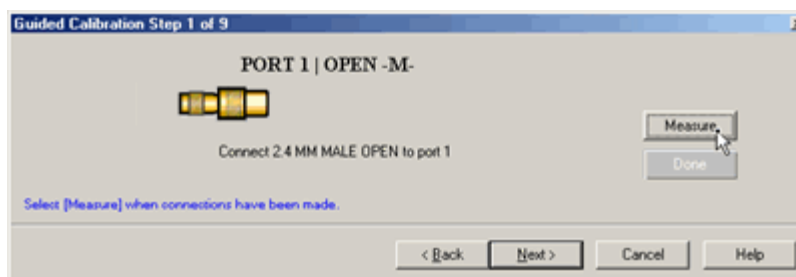

Follow the prompts to connect each standard. Then click **Measure**.
Click **Re-measure** if necessary.
Then click **Next >**

Finish Cal dialog box help

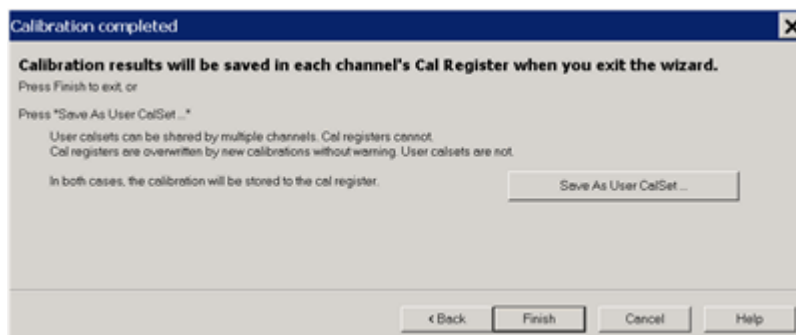

Click **Finish** to save the Cal All session results to Cal Registers.
Or click **Save As User CalSet**, then enter a prefix title. The Meas Class and channel number are appended to this prefix to save to a User Cal Set for each calibrated channel.

[Learn more about this dialog.](#)

E5080A

Last modified:

29-Sep-2015 First Release

Using Calibration Sets

- [What are VNA Cal Sets](#)
- [Cal Registers and User Cal Sets](#)
- [How to Manage and Apply Cal Sets](#)
- [Examples of Cal Set Usage](#)
- [Archiving Cal Sets using .cal files](#)

See Also

Save and Recall: [Instrument States and Cal Set Data](#)

See other Calibration Topics

What are VNA Cal Sets

At the completion of a calibration, all calibration data is stored to a Cal Set. The Cal Set can be applied later to any channel that has the same stimulus settings as the Cal Set, thereby saving the time it takes to perform another calibration. The following data is saved to a Cal Set:

- Name
- Cal Set Description
- Cal Set Attributes - stimulus settings, cal type, port association
- Standards data
- Error term data
- GUID (**G**lobally **U**nique **I**Dentifier)

Cal Registers and User Cal Sets

There are two types of Cal Sets:

- **Cal Registers** (channel specific)
- **User Cal Sets**

Calibration data is automatically saved to a Cal Register at the end of every calibration. You can also choose to save the cal data to a User Cal Set.

Calibration Registers

New with VNA Release 5.0, Calibration Registers are designed to simplify calibrations for most users. When a calibration is complete, the data is automatically saved to the channel's Cal Register, overwriting (or [appended to](#)) the previous cal data stored in that register. This concept is similar to previous Keysight Vector Network Analyzers.

- Every channel has ONE dedicated Cal Register. They are named CHn_CALREG, where **n** is the channel number. The name cannot be changed.
- Cal Registers are more volatile because they are overwritten (or [appended](#)) each time a calibration is performed on that channel. The Cal data is always saved, but only temporarily.

- Cal Registers can be applied to other measurements, but ONLY on the same channel as the Cal Register.

User Cal Sets

At the end of a calibration, you can choose to also save cal data to an existing or new User Cal Set.

- User Cal Sets can be applied to any number of channels simultaneously.
- User Cal Sets are named by you for easy identification.
- You can have an unlimited number of User Cal Sets.
- At any time, you can copy Cal Register data to create a User Cal Set. See [Cal Set Properties](#).

Note: You can set a Preference to revert the pre-5.0 behavior - Cal data was automatically saved to a User Cal Set instead of a Cal Register.

Appending Data in a Cal Set

At the end of a calibration, data is saved to the channel's Cal Register and, if you choose, to a User Cal Set. When you choose to save to an existing User Cal Set, the VNA attempts to append the new error terms to the existing User Cal Set. The existing Cal Set data is completely overwritten UNLESS the new data can coexist with the existing data according to the following two rules:

- The stimulus settings of the new data must exactly match the existing data.
- The new cal must involve different ports from the existing cal.

For example:

Case 1 - An existing Cal Set contains a full 2-port cal between ports 1 and 2. Using the same stimulus settings, you perform a 1-port cal on port 3. At the end of the cal, you click [Save As User Cal Set](#) and select the existing full 2-port User Cal Set.

Result: The 1-port cal is appended to the 2-port User Cal Set. There is NO overlap between them.

Case 2 - Same situation as Case 1, except the 1-port cal is performed on port 1.

Result: The Cal Set will contain a 1 port cal on port1 and a 1 port cal on port 2. The overlapping tracking terms are removed rendering the original full 2 port cal invalid.

How to Manage and Apply Cal Sets and Cal Types

The VNA attempts to apply a Cal Set, and turn error correction ON, for ALL of the measurements on the active channel. This may not always be possible. For example, suppose a channel contains both S11 (reflection) and S21 (transmission) measurements. If a Cal Set that contains only an S11 **Cal Type** is applied to that channel, the Cal Set does not contain the error terms to correct the S21 measurement. Error correction is turned ON for the S11 measurement and NOT turned on for the S21 measurement.

There are two ways to apply an existing Cal Set (Cal Register or User Cal Set) to a measurement:

1. Recalling an Instrument State with Cal data ([.cst file](#)) - A .cst file contains an Instrument State with all measurement attributes AND a 'pointer' to the Cal Set that was used to calibrate the measurement. Before saving a .cst file, be sure that a User Cal Set (NOT a Cal Register) is being used for the measurement. Because Cal Registers are automatically overwritten when a new calibration is performed, it is likely that the Cal Register data will change before the .cst file is recalled.
2. Create a new measurement and select a Cal Set to apply to the active channel.

Note: NEVER copy or modify Cal Sets from Windows Explorer or other applications. Cal Sets should only be accessed through the VNA Application.

How to select and apply a Cal Set to the active channel

Using **Hardkey/SoftTab/Softkey**

1. Press **Cal** > **Cal Sets & Cal Kits** > **Cal Set...**

Programming Commands

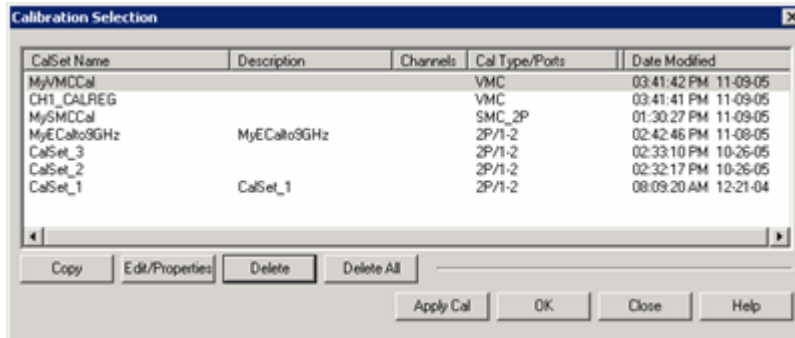

Calibration Selection dialog box help

This dialog box allows you to manage and apply Cal Sets.

Although the number of Cal Sets you can have is limited only by the amount of VNA memory, it is considered unusual to have more than about 10 existing Cal Sets, or one current Cal Set for every unique channel setup. Old Cal Sets (with 'stale' data) should be deleted or overwritten.

The active channel's Cal Register always appears, even if empty. Cal Registers that belong to other channels appear in the list of Cal Sets only if the channel exists, and only if they contain data.

- Learn about [Cal Registers](#).
- Learn how to [View the Error Terms of a Cal Set](#).

To apply a Cal Set to the active channel, click a row to select that Cal Set, then click Apply Cal.

Note: A Cal Set must have been generated from the same [measurement class](#) as the active channel in order for it to be Applied.

Columns click a heading to sort by that column

Cal Set Name Name to identify the Cal Set.

Description User-settable text to further identify the Cal Set.

Channels Channel numbers that are currently using this Cal Set. A blank entry means it is not currently in use.

CalType / Ports Type of Cal contained in the Cal Set. [Learn about applying appropriate Cal Types](#).

Cal Type Abbreviations:

1P, 2P, 3P, 4P... - Full n-Port calibration

+ - Indicates a Power Correction is included in the Cal Set

R - Response (instead of ports, shows the measurement type that it corrects.)

ER/x-y [Enhanced Response](#), where **x** is the receive port; **y** is the source port.

SMC Scalar Mixer Cal

Modified Date and time the Cal Set was last modified.

Buttons

Copy Invokes the [Save as User Cal Set](#) dialog box. Type a name for the copy of the selected Cal

Set data.

Edit / Properties Invokes the Cal Set Properties dialog box. This allows you to view all of the Cal Set properties and create a **duplicate** User Cal Set from an existing User Cal Set or Cal Register.

Delete Permanently deletes the Cal Set after you choose OK to a warning prompt.

Delete All Permanently deletes ALL listed Cal Sets and Cal Registers after you choose OK to a warning prompt.

Apply Cal Applies the selected Cal Set to the active channel. If the stimulus settings of the Cal Set and channel are different, [a choice must be made](#).

Unselect Available ONLY if the selected Cal Set is being used by the active channel. Click to 'Un-apply' the Cal Set, then click **Close** to exit with the Cal Set un-applied.

OK Always APPLIES THE SELECTED CAL SET to the active channel, then closes the dialog box.

Close Exit the dialog box. Performs no further action.

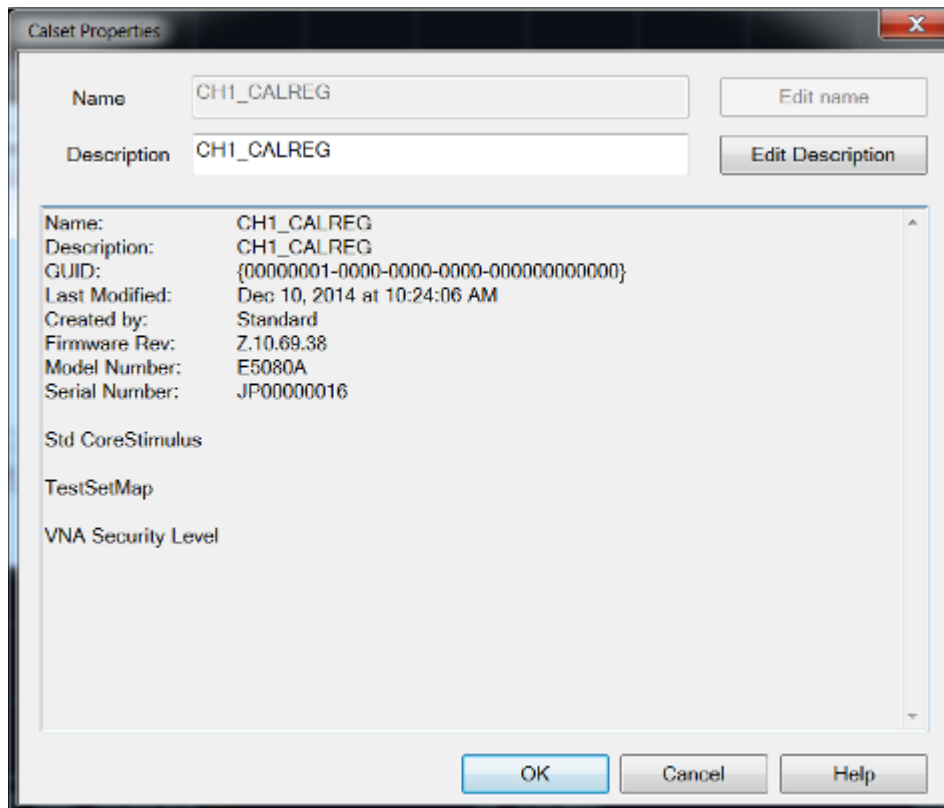

Cal Set Properties dialog box help

Allows you to view all of the Cal Set properties and create a **duplicate** User Cal Set from an existing User Cal Set or Cal Register.

Name Edit name of the User Cal Set. You can NOT change the name of a Cal Register.

Description Descriptive text to further identify the Cal Set.

Cal Set Properties Lists descriptive information and stimulus conditions of the Cal Set.

Learn how to [View the Error Terms of a Cal Set](#).

Stimulus Setting Different between Cal Set and Measurement

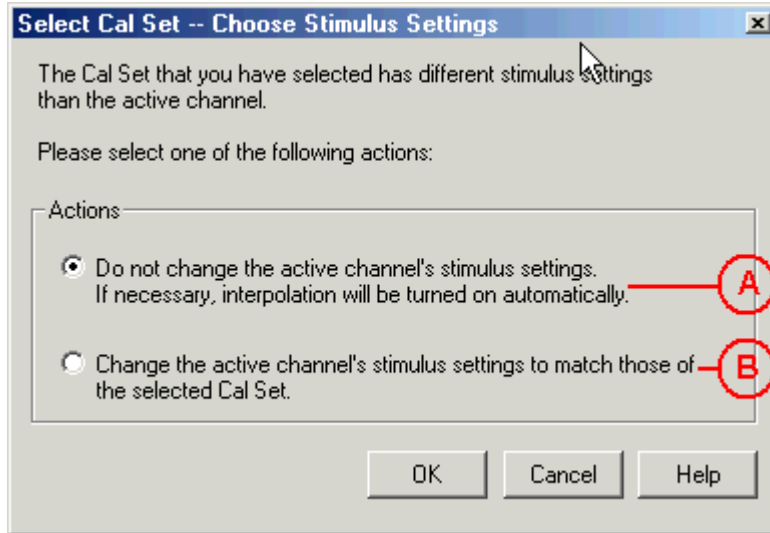

Select Cal Set -- Choose Stimulus Settings dialog box help

The Cal Set contains the channel stimulus settings that were in place when the Cal Set was saved. This dialog appears when the Cal Set channel settings are different than those of the channel to which the Cal Set is being applied. Choose between the following options.. (See above image).

- A. Keep the Active Channel Stimulus settings. Interpolate if possible.
 - If the Cal Set frequency range is greater the active channel, then Interpolation will be turned ON. Learn more about [Interpolation Accuracy](#)
 - If the Cal Set frequency range is less than the active channel, then this option is not available.
- B. Keep the Cal Set Stimulus settings. The Active Channel stimulus setting are changed.

OK Make the change.

Cancel Cal Set will NOT be applied.

Examples of Cal Set Usage

The following examples show how Cal Sets increase flexibility and speed in making analyzer measurements.

- Using one User Cal Set with many Channels
- [Using one Measurement with many Cal Sets](#)

Using one User Cal Set with many Channels

It is possible to do one calibration, then apply it to several channels.

An example:

During a manufacturing process, you may have many calibrated channels. You may wish to continuously cycle through the measurements and examine them individually. Occasionally, you may wish to refresh the calibration without having to recreate all the measurement state files.

Here is how: Examine the stimulus settings for each channel. Then make the User Cal Set stimulus range a super-set of the whole group. Each channel can then use the same User Cal Set. Some calibrations will be interpolated. **Note:** Make sure that [interpolation](#) is turned on.

Notice in the following image, Cal Set 78 is used on more than one channel, in this case Channel 5 and 16.

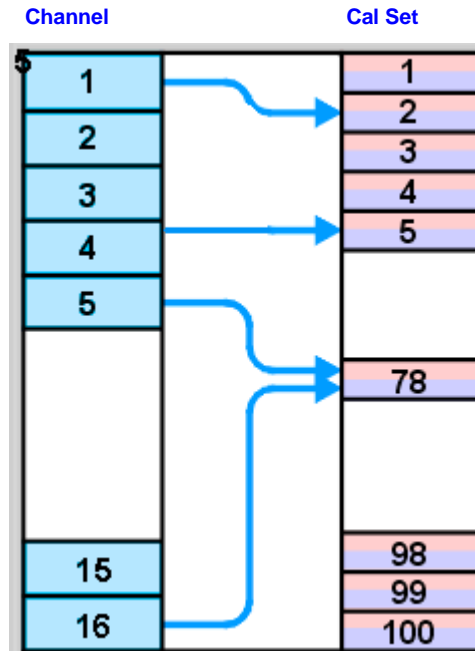

Using one Measurement with many Cal Sets

The drawback with having one very large User Cal Set associated with many instrument states could be a loss of accuracy due to interpolation. In such cases, consider using one User Cal Set for each stimulus setting. The stimulus conditions can then be changed for a channel by applying different User Cal Sets.

Other settings (window setups, measurement definitions, scaling, limits, markers) will not change. This may result in faster state changes than if you saved and recalled *.cst files for each set of stimulus conditions.

Example #1: An amplifier needs to be measured at several input power levels. Calibrate at several power levels and save each calibration in a separate User Cal Set. Then, apply the User Cal Sets to the single measurement consecutively.

Example #2: Making an S21 Measurement, you need to measure both wide span and narrow span characteristics of the device. One Cal Set covers the wide span setup; another the narrow span setup.

Archiving Cal Sets using .cal or .csa files

Because User Cal Sets can easily be deleted, provide extra backup by also saving your calibration as a .cal or .csa file ([see saving a .cal file](#)).

Example:

One person performs a calibration, names and saves it as a User Cal Set. This Cal Set is available for any other person to use. A second user could accidentally delete or modify the User Cal Set requiring the originator to repeat the calibration.

Security can be provided for calibration data by saving the Cal Set to a .cal file or .csa file. At a later time, the file could be recalled and the original calibration restored.

E5080A

Last modified:

29-Sep-2015 First Release





Error Correction and Interpolation

Error Correction and Interpolation settings work together to provide you with the highest level of calibration accuracy possible.

- [How to set Error Correction](#)
- [Error Correction](#)
- [Viewing Correction Levels](#)
- [How to set Interpolation](#)
- [Interpolation Accuracy](#)

See other Calibration Topics

How to set Error Correction

Using **Hardkey/SoftTab/Softkey**

1. Press **Cal** > **Main** > **Correction** > **Channel Correction On|Channel Correction Off**

◀ Programming Commands ▶

Error Correction

The Error Correction ON setting means that the calibration error terms are applied to the measurement. Error Correction is automatically turned ON when a calibration is performed or if a Cal Set is applied to a measurement. The VNA attempts to turn error correction ON for ALL of the measurements on the active channel. This may not always be possible when applying Cal Sets. For more information, see [Applying Cal Sets](#).

When full 2-port error correction is ON, both forward and reverse sweeps are required to gather all 12 error terms, even if only one reflection measurement is displayed. This may result in a higher measurement speed than expected. [Learn more.](#)

You can always turn Error Correction OFF for the active measurement by clicking Correction OFF. The VNA will turn Error Correction OFF automatically when making stimulus changes [under some conditions](#). To turn correction back ON, click **Correction ON**. Then:

- If Interpolation can NOT be performed, a dialog box will ask if you would like to [change the stimulus settings](#) to those of the applied calibration. Click OK or Cancel.
- If Interpolation can be performed, the stimulus setting will change and correction turned ON.

Viewing Correction Level

The correction level provides information about the accuracy of the active measurement. Correction level notation is displayed on the status bar for different calibration types like response, full 2-port, TRL, or power calibration.

To View Correction Levels:

In the **View** menu, click **Status Bar**. The status bar appears and displays the following items:

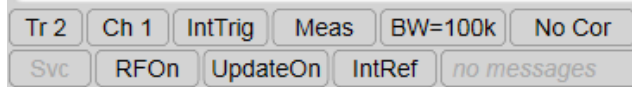

Correction Level		Accuracy
C	Full	Highest
C*	Interpolated	Uncertain
CΔ	Changed	Uncertain
No Cor	No Correction	Lowest

C Full Correction

Full Correction level is displayed immediately after a calibration is performed or when a valid Cal Set is applied. If you require optimum accuracy, avoid adjusting analyzer settings after calibration so your measurement remains at this level.

C* Interpolated Correction

"C star" appears in the status bar when a measurement is being interpolated. See Interpolation (above) and [Interpolation Accuracy](#).

CΔ Changed Settings

"C-delta" appears in the status bar when one or more of the following stimulus settings change. The resulting measurement accuracy depends on which parameter has changed and how much it has changed. For optimum accuracy, recalibrate using the new settings.

- [Sweep time](#)
- [IF Bandwidth](#)
- [Port power](#)
- [Stepped sweep enabled/disabled](#)

No Cor No Correction

The following will cause the VNA to turn Error Correction OFF for the channel:

- Decrease the start frequency
- Increase the stop frequency
- Change start frequency, stop frequency, or number of points with Interpolation OFF.
- [Change sweep type](#)

How to set Interpolation

Using **Hardkey/SoftTab/Softkey**

1. Press **Cal** > **Main** > **Interpolation** > **ON|OF**



Interpolation

Calibration interpolation adjusts calibration error terms to match changes to the following settings that you make AFTER a calibration is performed or a [Cal Set applied](#).

The Interpolation **ON** setting means that interpolation is **enabled** for the active measurement. This does not necessarily mean that the measurement is interpolated. When enabled (ON), if interpolation becomes necessary because you change any of the following stimulus settings, **then** interpolation will be applied. When stimulus settings change while interpolation is OFF, interpolation is NOT applied but instead, error correction is turned OFF.

Interpolation occurs (if enabled) when you change any of the following settings:

- Start frequency increased
- Stop frequency decreased
- Number of points

Note: Decreasing the start frequency, or increasing the stop frequency will always turn correction **OFF**. (Exception: [Power Calibration](#) DOES extrapolate to the start and stop frequencies.)

Interpolation Accuracy

When a measurement is interpolated, the accuracy of the measurements cannot be predicted. It may be affected significantly or not at all. Identifying measurement errors in these cases must be determined on a case-by-case basis. In general, the magnitude and phase stimulus from the VNA and the response from the DUT need to be smooth and continuous for measurement interpolation to give accurate results.

Significant measurement inaccuracy WILL occur when the phase shift response between measurement points increases changes more than 180 degrees. The VNA will incorrectly interpolate the new phase data. For more information, see [phase accuracy](#).

In general, the chances of significant inaccuracy increases when interpolating measurements under the following conditions:

- when frequency span between measurement points becomes much greater.
- when measurement frequencies are above 10 GHz where phase changes happen more rapidly.
- when interpolating across frequency band crossings. [Learn more about band crossings](#).

Note: When the interpolation algorithm encounters an abrupt or large change in the response magnitude or phase, such as can occur at band crossings, large interpolation errors can be included in the displayed data. These errors can be seen as steps or spikes. If this occurs, consider turning off interpolation, changing the measurement parameters, or creating [sweep segments](#) that skip over the band crossings.

Last modified:

29-Sep-2015 First Release

ECal

Using ECal

This topic discusses all aspects of performing an ECal:

- [ECal Overview](#)
- [Connect ECal Module to the VNA](#)
- [How to Perform a Calibration Using ECal](#)

See Also:

[ECal User-Characterization](#)

[Perform a 4-Port Cal with ONE 2-Port ECal Module](#)

[Restore ECal Module Memory](#)

See other Calibration Topics

ECal Overview

ECal is a complete solid-state calibration solution. Every ECal module contains electronic standards that are automatically switched into position during a VNA measurement calibration. These electronic standards have been measured at the factory and the data stored within the memory of the ECal module. The VNA uses this stored data, along with the PNA-measured data, to calculate the error terms for a measurement calibration.

ECal modules are available in 2-port and 4-port models and a variety of connector types, covering many frequency ranges. See [Analyzer Accessories](#) for more about available ECal modules and ordering information.

You can perform the following calibrations with ECal:

- 1-Port Reflection calibration
- Full 2-Port calibration
- Full 3-Port calibration
- Full 4-Port calibration

Verify the validity of a mechanical or ECal calibration with [ECal confidence check](#).

Care and Handling of ECal Modules

You can improve accuracy, repeatability, and avoid costly repair of equipment in the following ways.

- Practice proper connector care. See [Connector Care](#).
- Protect equipment against ESD damage. Read [Electrostatic Discharge Protection](#).

Power Level into an ECal module

- NEVER exceed the following Damage levels to the ECal module.
- For highest accuracy, do not exceed the following ECal Compression levels when calibrating:

Model	Compression level	Damage level
N469x series	-5 dBm	+10 dBm

N4432A series N4433A series	-7 dBm	+20 dBm
N4431x series	+7 dBm	+20 dBm
8509x series	+9 dBm	+20 dBm

Connect ECal Module to the VNA

ECal modules are controlled and powered through a USB connection to the VNA. When you connect the module, the VNA automatically recognizes the type of module, frequency range, and connector type.

ECal modules connect to the USB port on the front or rear panel of the VNA.

1. Wear a grounded wrist strap when making connections.
2. Connect the USB cable **Type B** connector to the ECal module and the USB cable **Type A** connector to the front or rear panel USB connector of the analyzer.

Notes:

- Unused ECal modules that have completed a calibration may remain connected to the USB port.
- You can connect and disconnect the ECal module while the analyzer is operating. However, DO NOT connect or disconnect the module while data transfer is in progress. This can result in damage or at least corrupted data.

How to Perform a Calibration Using ECal

Select an ECal module that has connectors of the same type and gender as the DUT. If such an ECal module is not available, a module with connectors different from the DUT can be used by using [Advanced Settings](#) or [User Characterization](#). See Also: [Perform a 4-Port Cal with ONE 2-Port ECal Module](#)

Connect the ECal module ports to the VNA ports. During the calibration process the VNA can either automatically detect how the ECal module is connected, or the orientation can be performed manually.

1. Connect the ECal module USB cable to the analyzer USB. See [Connect ECal Module USB to VNA USB](#).
2. Allow the module to warm up until it indicates **READY**.
3. Enter the analyzer settings. See Set Up Measurements.
4. Do one of the following to start the [Calibration Wizard](#)

Using **Hardkey/SoftTab/Softkey**

1. Press **Cal** > **Main** > **Ecal...**

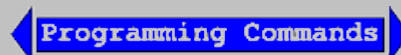

2. In the [Guided Calibration Wizard](#) dialog box (step 2), select ECal option from the Cal Kits combo box..

Select Calibration Ports and ECal Module dialog box help

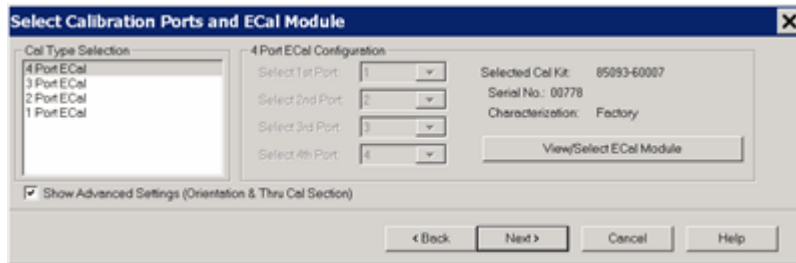

Allows you to select calibration type and settings.

Cal Type Selection / Configuration Select the number of ports to calibrate. Then select the port number configuration.

4 Port ECal Available only if using a 4-port VNA. No additional configuration necessary.

3 Port ECal Available only if using a 4-port VNA.

2 Port ECal

1 Port ECal- (Reflection) Advanced Settings are not available.

View/Select ECal Module Click to [Select the ECal module](#) if more than one ECal module is connected to the VNA. Also, [Select the User Characterization](#) within the module. Learn more about [User Characterization](#).

Show Advanced Settings Check to display the [Advanced Settings](#) when **Next** is clicked.

Back Return to [Cal Wizard Begin](#) dialog. If checked, you can clear the [Save Preferences](#) checkbox to see the Begin page when the Cal Wizard begins.

Note: The VNA no longer allows ECal isolation to be performed. The inherent isolation of the VNA is better than that attained with correction using an ECal module.

Note: Terminate any unused ECal ports with a 50 ohm load.

Note: Do not connect any USB memory during ECal calibration.

ECal module not found dialog box help

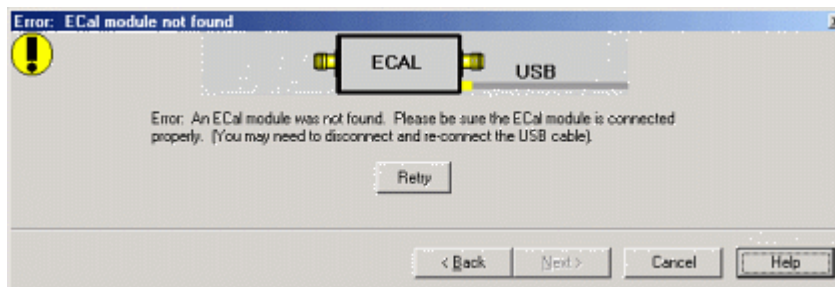

When this dialog appears, the ECal module is not connected or has not been recognized by the network analyzer.

Retry Check the USB connections and click to continue.

Notes:

- If your ECal module is not detected, try to unplug, then reconnect the USB connector to the VNA.
- When the ECal module is connected to the network analyzer for the first time, it may take approximately 30 seconds for the analyzer to recognize the module and make it available for calibration.

- For best accuracy, allow the ECal module to warm-up until it indicates READY.
- Keysight 8509x and N4431 ECal modules, when first connected, draw significantly more current than other modules. This could cause the USB to stop working in certain situations. See USB limitations.
- See [Connect ECal Module USB to VNA USB](#).

Select Module and Characterization dialog box help

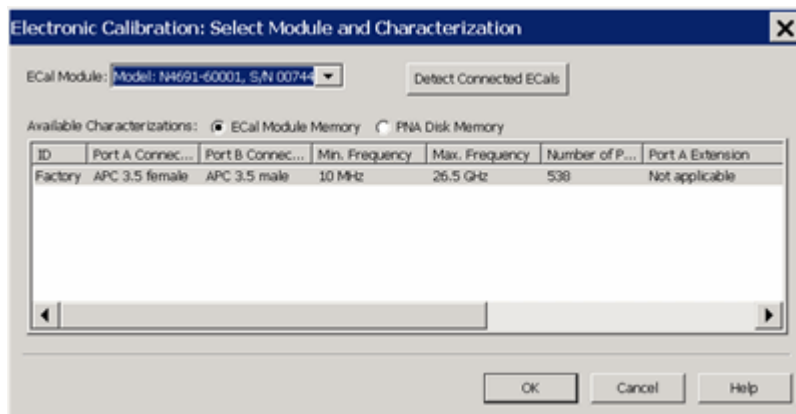

ECal Module Select one of the ECal modules that are connected to the VNA.

Detect Connected ECals Click to rescan the USB for ECal modules.

Available Characterizations

ECal Module Memory - Displays the factory and [user characterizations](#) that are stored in the ECal module.

VNA Disk Memory - Displays the user characterizations that are stored in VNA Disk Memory. [Learn more User Characterizations in VNA Disk Memory](#).

Select either the characterization data to use for the calibration. Once selected, that characterization becomes the default selection until the VNA is turned OFF and restarted. When restarted, **Factory** again becomes the default selection.

Error: Frequency Range dialog box help

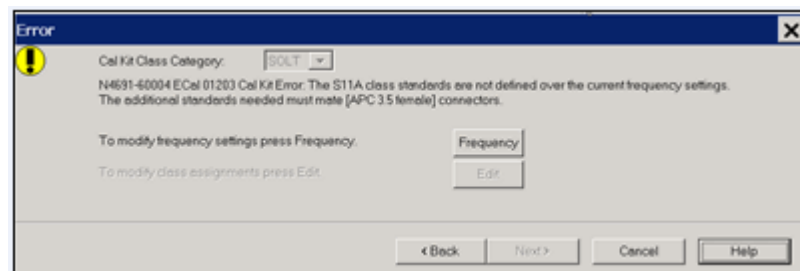

When this dialog appears, the current cal standards (or ECal module) does not cover the current frequency range of the measurement. Do one of the following to correct the problem:

Cal Kit Class Category Not available with ECal modules.

Frequency Change the frequency range of the active channel.

Edit Not available with ECal modules.

Back Select a different characterization that covers the required frequency range.

Cancel Re-characterize the module with an increased frequency range.

Select DUT Connectors and Cal Kits dialog box help

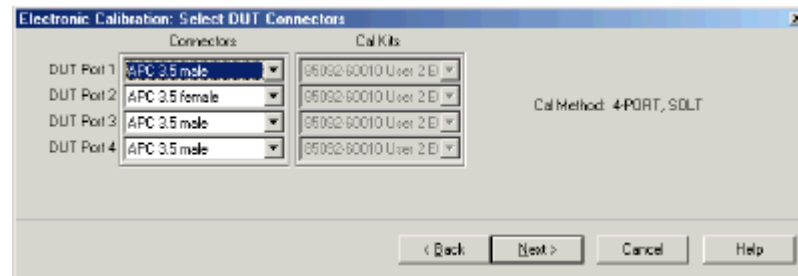

If the ECal module or selected User Characterization has more than one connector type, then the following dialog box is presented which allows you to describe the DUT connector type. Otherwise, click next to proceed to [Advanced Settings](#) (if checked) or [ECal Steps](#).

Connectors

The available connectors are listed for each DUT port.

Advanced Settings dialog box help

Thru #n

Lists the proposed Thru connections to be made during the calibration process. You can change these Thru connections to better suit your test setup.

- The proposed Thru connections are listed automatically.
- Additional Thru connections can be selected for higher accuracy. [Learn more](#).
- For Balanced measurements, [learn which Thru paths to select](#).

Add Thru

Click to add a Thru connection. [Learn more](#)

Remove Thru

Select a Thru by clicking the "Thru #N" field or the "1st Port / 2nd Port" field. Then click "Remove Thru". This selection is NOT available if the selected Thru is required for the calibration.

1st Port / 2nd Port

Click to change the two ports to be included in the Thru connection. The order of the port numbers (1st or 2nd) is not critical.

Thru Cal Method

Lists the available Thru Cal methods for the specified port pairs.

[Learn about ECal Thru Methods](#)

Cal Type/ Stds

Click to invoke the [View / Modify Properties of Cal dialog box](#)

Do orientation

When this box is checked (the default setting) the VNA automatically senses the model and direction in which an ECal module port is connected to the VNA ports. If power to the ECal module is too low, it

will appear as if there is no ECal module connected. If you use low power and are having this problem, clear this check box to provide the orientation manually.

Orientation occurs first at the middle of the frequency range that you are calibrating. If a signal is not detected, it tries again at the lowest frequency in the range.

Choose delta match

Available only when a Delta Match Cal is required.

- Check, then click **Next** to invoke the [Select Cal Set for Delta Match](#) dialog box.
- Clear - The Cal Wizard uses the Global Delta Match Cal if available.

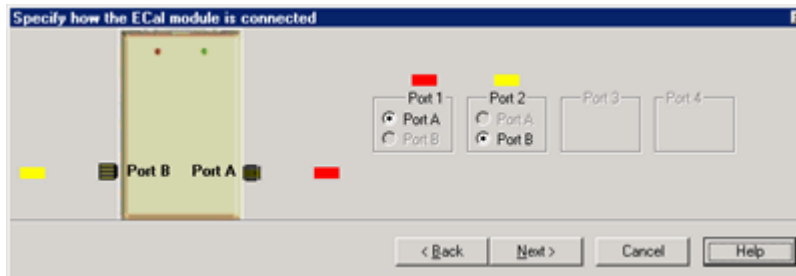

Specify how the ECal module is connected dialog box help

This dialog box appears when the **Do orientation** checkbox in the previous dialog box is cleared. Click the ECal Port that is connected to each VNA port.

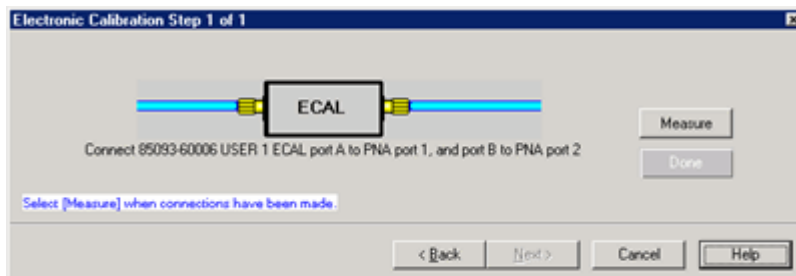

Electronic Calibration Steps dialog box help

Note: ECal can be performed with External triggers. [Learn more.](#)

Displays the instructions for each measurement required for calibration.

Measure Measures the ECal standards.

Done Click when last standard has been measured.

Saving an ECal Calibration

When complete, you can save the new calibration. [Learn how.](#)

Last modified:

E5080A

8-Sep-2014 First Release



ECal User Characterization

- [Overview](#)
- [How to Perform a User Characterization](#)
- [Manage Disk Memory](#)
- [Restore ECal Module Memory](#)

See Also

[Using ECal](#)

[Perform a 4-Port Cal with a 2-Port ECal Module](#)

Other Calibration Topics

Overview

A user-characterized ECal module allows you to add adapters to the ECal module, re-measure the standards in the ECal module, INCLUDING the adapters, then add that data to ECal memory or save it to the VNA hard drive. This extends the reference plane from the module test ports to the adapters.

Why perform a User Characterization?

- If you need to use adapters with your ECal module, you could characterize your ECal module with the adapters attached and perform subsequent ECals in a single step.
- If you have a 4-port ECal module, you could configure the module with adapters of different connector types, then perform a User Characterization of the module. When you need to test a DUT with a pair of the connector types on your module, calibrate the VNA with a 1-step ECal using the same two connectors on the User-characterized module.
- If you test devices in a fixture, you could embed the characterization of the fixture in the characterization of the module. To do this, during the mechanical calibration portion of the User Characterization, calibrate at the reference plane of the device as you would normally calibrate. Then remove the fixturing to be embedded and insert the ECal module to be characterized. When measuring the ECal module, the VNA removes the effects of the fixturing and stores the measurement results in the user characterized ECal module. Subsequent calibrations with that user-characterized module will also remove the fixture effects.

Notes:

- Both 2-port and 4-port ECal modules support User Characterization.
- User Characterization does not delete the factory characterization data. The factory data is saved in the ECal module in addition to the User Characterization data.
- The ECal Data Wipe Utility is the only way that data can be deleted from the module. Learn more at <http://na.tm.keysight.com/pna/apps/applications.htm>.
- A User Characterization can be performed beyond the frequency range of the ECal module. Although this practice is allowed, calibration accuracy with the extended User Characterization is likely to be degraded. To determine the level of degradation, compare measurements of a variety of devices using a VNA with a mechanical cal kit calibration versus an ECal extended User Characterization calibration.

- You can save up to 12 User Characterizations in a single ECal module. Previous releases allowed up to 5. There are memory limitations. The VNA will determine if the contents of a User Characterization will fit inside the module before it is performed.
- Saving a new User Characterization with VNA releases **before** A.08.33 will erase any User Characterizations greater than 5. This is because the VNA completely rewrites ALL ECal User Characterizations when saving a new one in order to free storage space in the ECal module.
- A User Characterization can be performed remotely. See programming commands.

User Characterizations can be saved to the **VNA Disk Memory**. [Learn how](#). Previously, User Characterizations could be saved only to the ECal module memory.

This feature provides the following benefits:

- A User Characterization using connectors that are NOT included in the [supported connector table](#) can NOT be stored to the ECal module. But when stored to disk memory, ANY connector type is allowed by firmware using a description of any length for the User Characterization.
- There is NO limit to the number of data points allowed in a User Characterization stored to disk memory. When stored in the ECal module, the number of data points is limited by the VNA firmware.
- The number of User Characterizations that can be stored to disk memory is limited only by available disk space.
- User Characterizations stored to disk memory can be freely shared between VNAs.

[Learn how to Manage User Characterization in Disk Memory](#).

How to Perform a User Characterization

SUMMARY (A [detailed procedure](#) follows.)

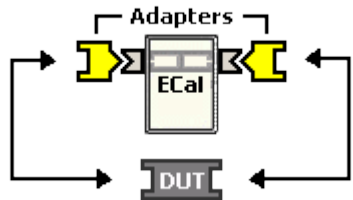
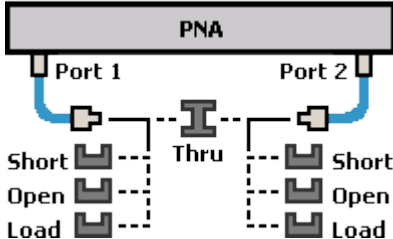
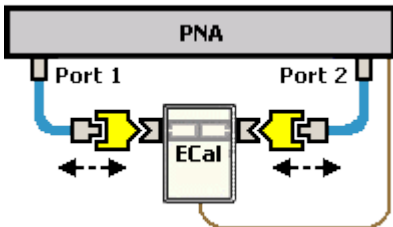
	<p>1. Select adapters for the module to match the connector configuration of the DUT.</p>
	<p>2. Either calibrate the VNA using mechanical standards or recall an existing Cal Set.</p>
	<p>3. Measure the ECal module, including adapters, as though it were a DUT.</p>

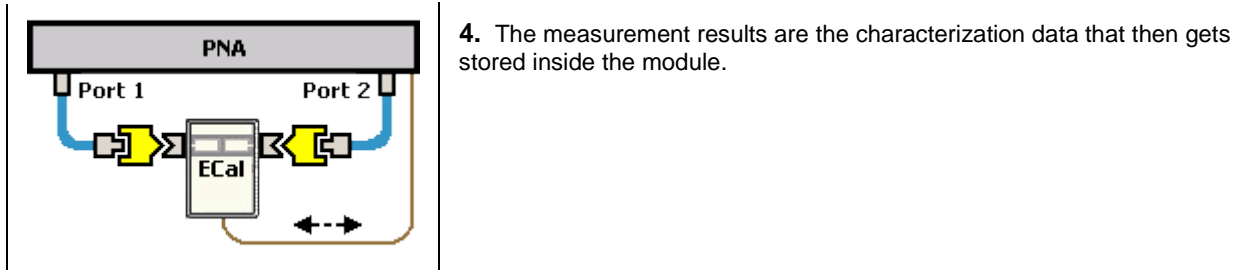
**Note****A 2-port VNA can be used to perform a User Characterization on a 4-port ECal module.**

However, a 4-port ECal module has SIX different port pairs. The VNA must be recalibrated for each port pair that uses unique connector types or gender.

- If all 4 ECal module ports have the same connector type and gender, then only one VNA calibration is required to measure all six port pairs.
- If all 4 ECal module ports have different connector types or gender, then 6 calibrations are required.

When more than one VNA calibration is required during a User Characterization, then ALL calibrations must be performed using the standard Cal Wizard, saved to Cal Sets, and then [recalled from Cal Sets](#) DURING the User Characterization.

Detailed steps to Perform a User Characterization

1. Connect the ECal module to the network analyzer with the USB cable. See [Connect ECal Module USB to VNA USB](#).
2. Allow the module to warm up until it indicates **READY**.
3. **Preset** the analyzer.
4. Set up the measurement. For best accuracy, the **IF bandwidth** should be set to **1 kHz** or less.
5. Start and complete the **Characterize ECal Module** Wizard:

Using Hardkey/SoftTab/Softkey

1. Press **Cal** > **Cal Sets & Cal Kits** > **Characterize ECal...**

◀ **Programming Commands** ▶

Select Module and Location dialog box help

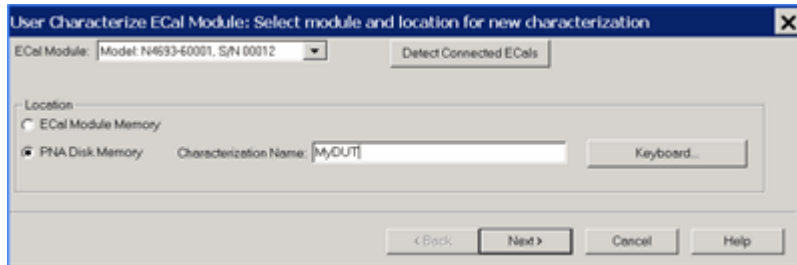

ECal Module Select one of the ECal modules that are connected to the VNA.

Detect Connected ECals Click to rescan the USB for ECal modules.

Location

- **ECal Module Memory** Click Next to see the following dialog.
- **VNA Disk Memory** Enter a Characterization Name. This name appears when selecting a User Characterization to be used with subsequent calibrations.
 - [Learn how to manage characterizations that are stored to VNA disk memory.](#)
 - [See the benefits of storing the User Characterization to VNA Disk Memory.](#)

Keyboard Launches a keypad that can be used to type a characterization name from the VNA front panel.

Next Click to continue to the [Select Connectors for the Characterization](#) dialog box.

[See note regarding extended frequency use.](#)

Select User Number for new characterization dialog box help

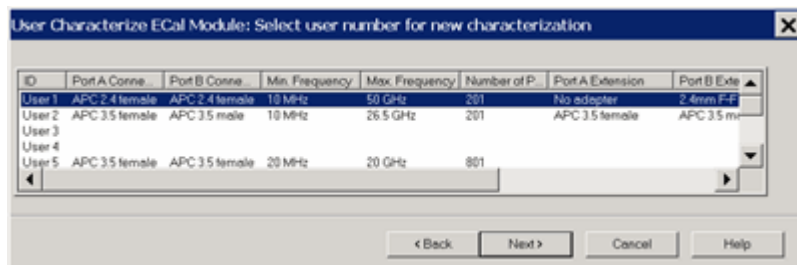

Scroll to view all of the parameters of the stored characterizations. Select an empty location or select to overwrite an existing characterization.

Next Click to continue to the [Select Connectors for the Characterization](#) dialog box.

[See note regarding extended frequency use.](#)

Select Connectors for the Characterization dialog box help

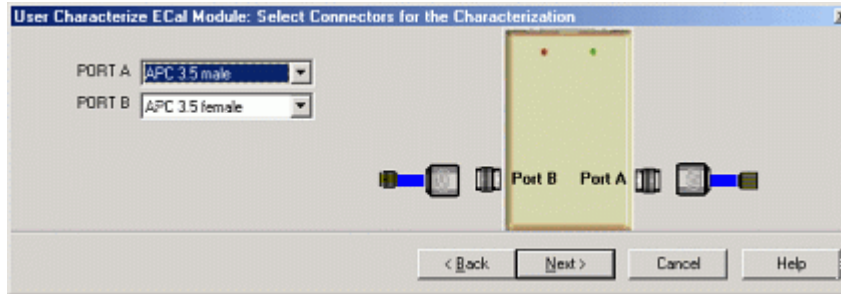

Connector Notes

When performing an ECal User Characterization, do NOT use a [custom connector name](#) that you added to this list. If you need to use a custom-defined connector type, select "Type B", or one of the "Type A" variations from the list of connectors for each port.

A User Characterization using connectors that are NOT included in the [supported connector table](#) can NOT be stored to the ECal module. But when stored to disk memory, ANY connector type is allowed. [Learn more about storing to VNA Disk Memory.](#)

Select the adapters for the ECal module test ports. Select **No adapter** if no adapter is used on a port.

PORT A Lists the connector types available for Port A.

PORT B Lists the connector types available for Port B.

PORT C Lists the connector types available for Port C (available with a 4-port ECal module).

PORT D Lists the connector types available for Port D (available with a 4-port ECal module).

Next Click to continue to the [Calibrations to perform or recall](#) dialog box.

Calibrations to perform or recall dialog box help

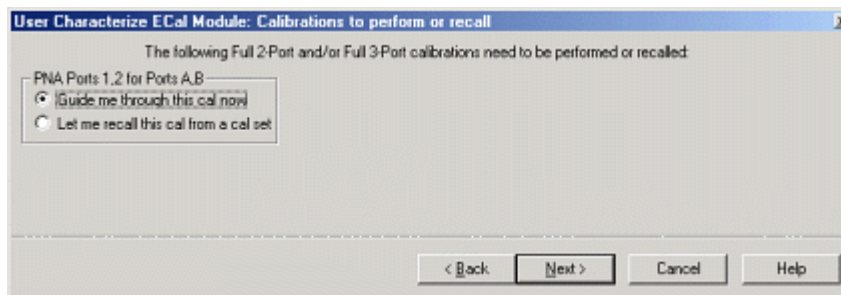

The VNA must be calibrated before measuring the ECal module and necessary adapters. This dialog box displays the number and types of mechanical calibrations required for the characterization.

Guide me through this cal now Click to perform a Guided calibration. A calibration kit is required for each connector type.

If more than one calibration is required, this selection is not available. [See Note.](#)

Let me recall this cal from a cal set Click to select an existing Cal Set. You cannot select a Cal Set that is currently in use. Learn more about [Using Cal Sets.](#)

Next Click to continue to either the [Select Cal Kits](#) or the [Select Cal Set](#) dialog box.

Select Cal Kits dialog box help

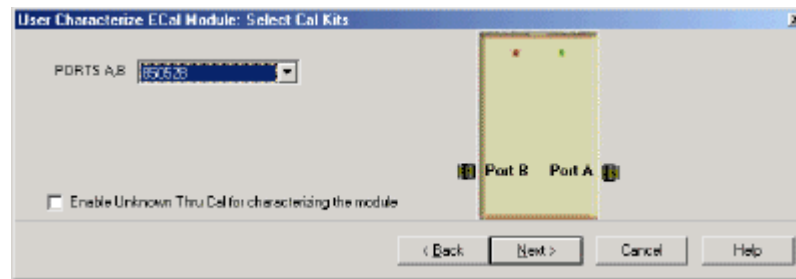

Provides a list of calibration kits to perform the calibration. Select the Cal Kit you will use for each port.

Enable Unknown Thru for characterizing the module Check to enable. This reduces the number of steps required to characterize the THRU standard. This setting is available only on VNA models with one reference receiver per test port.

Next Click to continue to the [Select Cal Set](#) dialog box.

Select Cal Set dialog box help

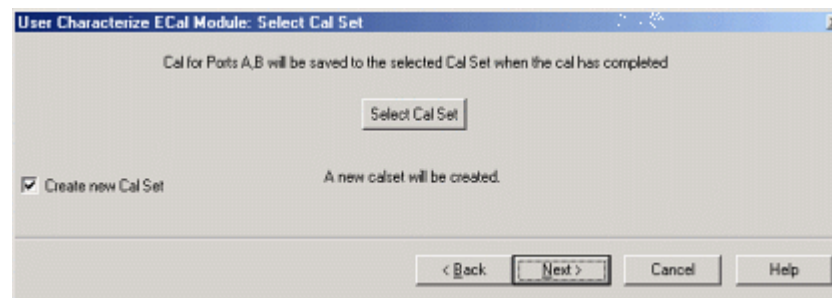

The calibration that you perform will be written to a Cal Set. This dialog box allows you to select a Cal Set to overwrite, or to write to a new Cal Set. The current choice is visible below the **Select Cal Set** button.

Select Cal Set Click to open the **Select A Cal Set** dialog box.

Create new Cal Set Check to create a new Cal Set to store the calibration. Clear to select and overwrite a stored Cal Set.

Next Click to continue to the [Guided Calibration Steps](#) dialog box.

Note: Remember the Cal Set name for future reference.

Guided Calibration Steps dialog box help

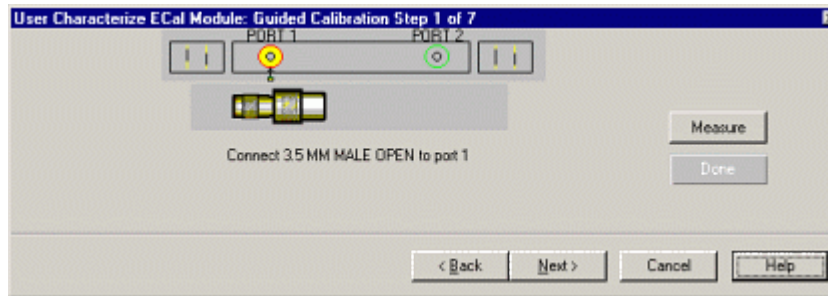

Instructs you to connect each calibration standard to the measurement port.

Measure Click to measure the standard.

Back Click to repeat one or more calibration steps.

Done Click **after** a standard is re-measured and all measurements for the calibration are complete.

Next Click to continue to the next calibration step. (Does **not** measure the standard.)

Cancel Exits Calibration Wizard.

The **Specify nominal delay** or **Guided Calibration completed** dialog box appears when the steps are completed.

Specify nominal delay dialog box help

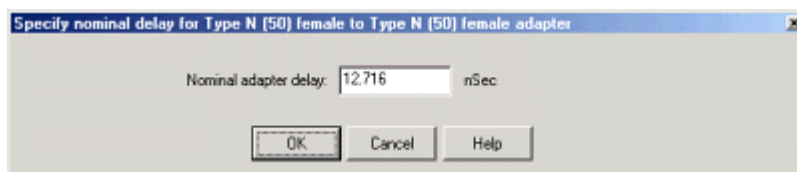

This dialog ONLY appears when [Adapter Removal](#) or [Unknown Thru](#) calibrations are performed.

The following values were estimated from the measurement. Most of the time, they are adequate. However, for CW sweep or frequency sweep with large step sizes, the accuracy of the values may be improved.

Nominal adapter delay To improve this value, measure and record the delay of the adapter with a dense step size. Enter that value here.

Nominal phase offset (Waveguide ONLY). To improve this value, measure and record the phase offset of the Waveguide adapter with dense step size. Enter that value here.

When one connector is coax and the other connector is waveguide, the phase offset has an ambiguity of 180 degrees. For consistency, the estimate provided here is always between 0 and 180 degrees. You can change this estimate to any value between -180 degrees and +180 degrees.

Guided Calibration completed dialog box help

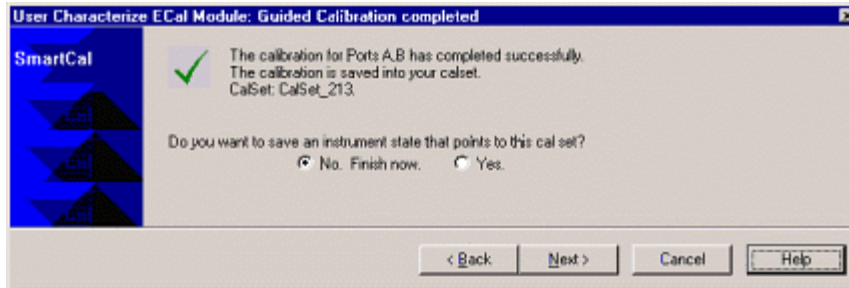

Allows you to finish the calibration and continue to the next characterization steps.

No. Finish now Select to save Cal Set data.

Yes Allows selection of Save options.

Next Click to continue to the [Exit to Inspect Quality of Calibration](#) dialog box.

Exit to Inspect Quality of Calibration dialog box help

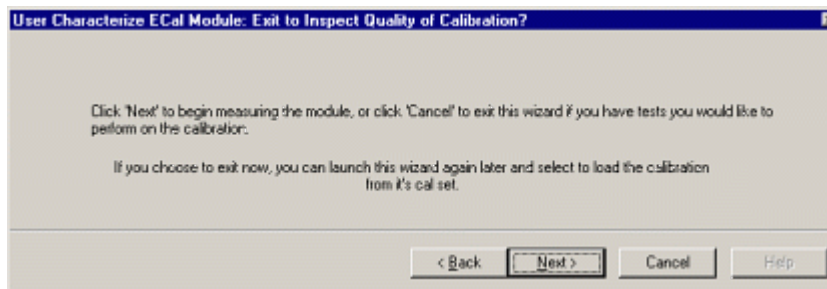

Allows you to exit User Characterization to [validate the calibration](#) before proceeding with the characterization.

Back Allows you to repeat calibration.

Next Click to continue to the [Characterization Steps](#) dialog box.

Cancel Exits the Calibration.

To return to the current step:

1. Start User Characterization.
2. In the **Select user number for new characterization** dialog box, click **Next**.
3. In the **Select Connectors for Characterization** dialog box, click **Next**. (Previous entry is stored in memory.)
4. In the **Calibrations to perform or recall** dialog box, recall the Cal Set that you just performed.

Characterization Steps dialog box help

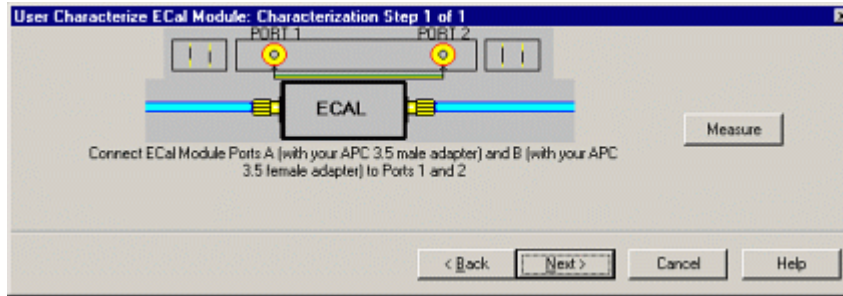

Describes the instructions for each measurement required for characterization.

Measure Measures the ECal module.

Next Click to continue to the [Information for the New Characterization](#) dialog box when measurements are complete.

Information for the New Characterization dialog box help

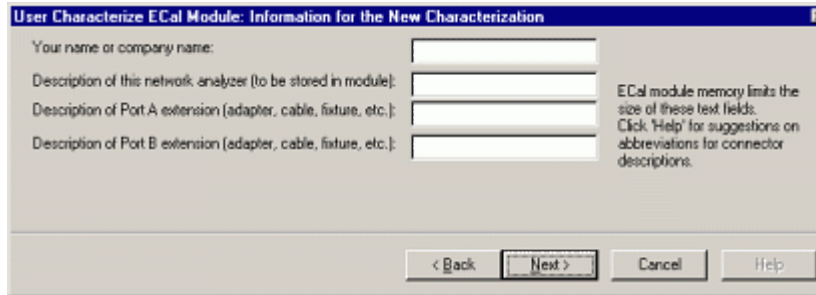

Allows you to describe the properties of the User Characterization.

Suggestions for connector abbreviations

To minimize the number of characters, we suggest using the following 3-character codes to describe the connectors listed.

A User Characterization using connectors that are NOT included on this list can NOT be stored to the ECal module. But when stored to disk memory, ANY connector type is allowed. [Learn more about storing to VNA Disk Memory.](#)

Connector Type	3-Character Code
1.0 mm female	10F
1.0 mm male	10M
1.85 mm female	18F
1.85 mm male	18M
2.4 mm female	24F
2.4 mm male	24M
2.92 mm female	29F

2.92 mm male	29M
3.5 mm female	35F
3.5 mm male	35M
7-16 female	16F
7-16 male	16M
Type F female	F7F
Type F male	F7M
N50 female	N5F
N50 male	N5M
N75 female	N7F
N75 male	N7M
APC 7	7MM
K-band waveguide	KBW
P-band waveguide	PBW
Q-band waveguide	QBW
R-band waveguide	RBW
U-band waveguide	UBW
V-band waveguide	VBW
W-band waveguide	WBW
X-band waveguide	XBW

Next Click to continue to the [Write Characterized Data to the ECal module](#) dialog box.

Write Characterized Data dialog box help

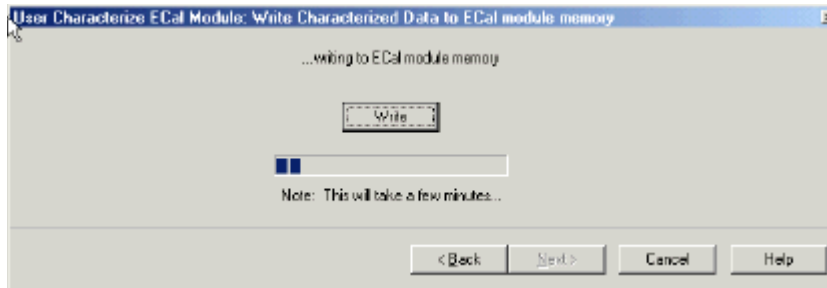

The VNA writes User Characterization and factory characterization data to either the VNA disk memory or the ECal module memory.

Write Click to write data.

The [Summary of new User Characterization](#) dialog box opens after data is saved to module.

- Existing data will be overwritten if you selected a User Characterization number that already has data. [Learn more](#)
- For more information, see [Restore ECal module memory](#).
- The ECal Data Wipe Utility is the only way that data can be deleted from the module. Learn more at <http://na.tm.Keysight.com/pna/apps/applications.htm>.

Summary of new User Characterization dialog box help

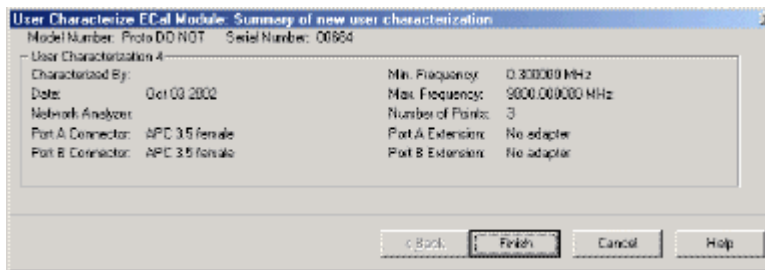

Verify the status of the ECal User Characterization.

- ECal module model number
- summary from User Characterization

Cancel Click to exit (characterization complete).

Finish Click to exit (characterization complete).

Manage ECal User Characterizations in Disk Memory

Normally, User Characterizations that are stored in VNA disk memory can be used indefinitely without needing them to be managed. However, this dialog allows you to backup the characterizations in case they are accidentally erased, or to save them to a file that can be moved to another VNA.

How to Manage ECal User Characterizations in Disk Memory

Using **Hardkey/SoftTab/Softkey**

1. Press **Cal** > **Cal Sets & Cal Kits** > **ECal Memory...**

◀ **Programming Commands** ▶

Manage ECal User Characterizations in Disk Memory dialog box help

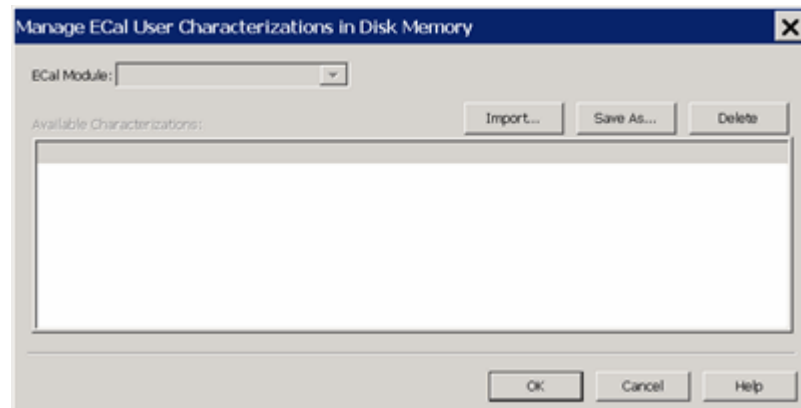

This dialog allows you to do either of the following:

- Save an existing User Characterization in disk memory to an *.euc file.
- Load a previously saved *.euc file for use on the VNA with the specified ECal module.

[Learn more about User Characterizations stored to Disk Memory.](#)

ECal Module Select an ECal Module from the list for which User Characterizations are currently stored in VNA disk memory.

Save As Saves a User Characterization that is currently in VNA disk memory to a *.euc file. This file can be used as a backup in case the archive file is accidentally deleted, or allows you to move the file to another VNA to be used with the selected ECal Module.

Import Loads a previously saved *.euc file for use on the VNA with the specified ECal module.

Delete Removes a User Characterization from VNA disk memory.

Restore ECal Module Memory

When user-characterized data is written to the ECal module, the entire contents of ECal memory is also written to the VNA hard drive, including the factory ECal data. In the unlikely event that your ECal module memory is lost, you can restore all ECal data to ECal memory.

Caution: If a new factory cal was performed **after** the ECal memory was written to the VNA, the new factory cal data will also be overwritten.

Note: An ECal Data Wipe Utility destroys all user data per US DoD 5220.22-M. Learn more at <http://na.tm.Keysight.com/pna/apps/applications.htm>

How to Restore ECal Module Memory

Using **Hardkey/SoftTab/Softkey**

1. Press **System** > **Service** > **Restore Ecal Memory**

No Programming commands are available for this feature.

Module to be restored dialog box help

3. Calibrate a Measurement

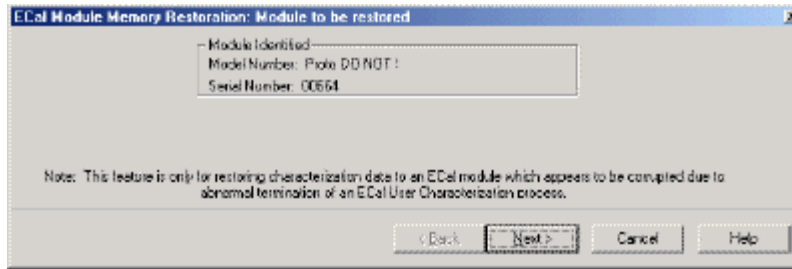

Verify the serial number of the module to be restored. If two modules are connected to the VNA , choose the one to have data restored.

Next Click to write data to the module.

Last modified:

8-Sep-2014 First Release



Perform a 4-Port Cal with One 2-Port ECal Module

You can perform a 4-port calibration with a 2-Port ECal Module. When all four DUT connectors are the same type and gender, the calibration can occur with only four connections, the same number of connections you would make with a 4-port ECal module.

- The ECal module must span the frequency range of the measurement.
- The ECal module must have connectors that match the DUT connectors. Because we are using a 2-port ECal module, this means that the DUT must have only TWO unique connector types and gender. When the DUT has more than two connector types/genders, you can select a different cal kit for each port using SmartCal.

Procedure

1. Connect the 2-port ECal module to a VNA USB port.
2. Press **Cal**, then **Start Cal**, then **Cal Wizard**
3. Select either **SmartCal** or **Use Electronic Calibration** then click **Next**.
4. Select **4 Port Cal**, then click **Next** to see the following dialog:

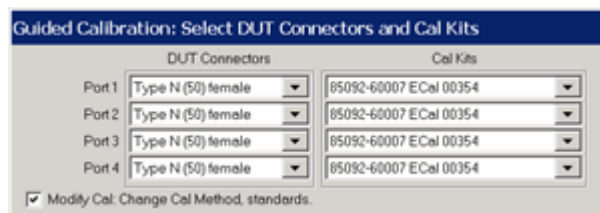

5. Select the DUT Connectors for each port. In this example, all four DUT connectors are Type N, female.
6. Select the attached ECal module. We are using a **85092-60007 ECal** module.
7. Select **Modify Cal (Show Advanced Settings for ECal)** then click **Next** to see the following dialog:

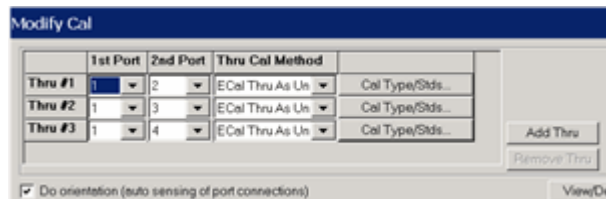

8. For the fewest number of physical connections, select the default port assignments.
 7.
 - The **1st Port** selection for each port pair is 1.
 - For single-ended (standard) measurements, THREE is the minimum number of Thru connections. For Balanced measurements, FOUR Thru connections should be made. [Learn more.](#)
 - For higher accuracy, select **Add Thru**. The Cal Wizard will add another port pair which results in more physical connections.
8. Select **ECal Thru as Unknown**. This is the most accurate and easiest Thru Cal Method. [Learn more.](#)

9. You may need to clear **Do Orientation** when calibrating at low power levels. [Learn more](#). This will add additional connection steps.
 10. Follow the prompts to complete the calibration:
 10.
 1. Connect ECal to ports 1 and 2. Click **Measure**.
 2. Connect ECal to ports 1 and 3. Click **Measure**.
 3. Connect ECal to ports 1 and 4. Click **Measure**.
 11. At the **Specify Delay** dialogs, click **OK**. This is the measured delay for each of the Thru connections in the ECal module. [Learn more](#).
 12. Click either **Save As User Cal Set**, or **Finish**.
-

Last modified:

2-Aug-2011 New topic

TRL Calibration

TRL (Thru, Reflect, Line) represents a **family** of calibration techniques that measure two transmission standards and one reflection standard to determine the 2-port 12-term error coefficients. For example, **TRM** (Thru, Reflect, Match), **LRL** (Line, Reflect, Line), **LRM** (Line, Reflect, Match) are all included in this family.

The traditional SOLT calibration measures one transmission standard (T) and three reflection standards (SOL) to determine the same error coefficients.

- [Why Perform a TRL Cal?](#)
- [The TRL Calibration Process](#)
- [TRL Cal Kits](#)
- [Cal Standards Used in TRL](#)
- [TRL with an External Test Set](#)

See other Calibration Topics

Why Perform a TRL Cal?

TRL calibration is extremely accurate, in most cases more accurate than an SOLT cal. However, very few calibration kits contain TRL standards. TRL Cal is most often performed when you require a high level of accuracy and do not have calibration standards in the same connector type as your DUT. This is usually the case when using test fixtures, or making on-wafer measurements with probes. Therefore, in some cases you must construct and characterize standards in the same media type as your DUT configuration. It is easier to manufacture and characterize three TRL standards than the four SOLT standards.

Another advantage of TRL calibration is that the TRL standards need not be defined as completely and accurately as the SOLT standards. While SOLT standards are completely characterized and stored as the standard definition, TRL standards are modeled, and not completely characterized. However, TRL cal accuracy is directly proportional to the quality and repeatability of the TRL standards. Physical discontinuities, such as bends in the transmission lines and beads in coaxial structures, will degrade the TRL calibration. The connectors must be clean and allow repeatable connections.

To learn more about Cal Standard requirements, see [Cal Standards Used in TRL](#).

Note: Virtual Device describes a non-physical (connect the two test port reference planes together) type of connection description during the calibration. So, in a cal kit definition, you should in general **not** define more than one Thru standard with the same connector/gender pairing to each be a **Virtual Device**. That could cause those Thru standards to all be treated as the same physical connection step during a calibration, which would especially be a problem for TRL calibrations if a Thru standard and Line standard were measured as the same connection step.

The TRL Cal Process

Although TRL can be performed using the Cal Wizard Unguided Cal selection, the following process uses the easier [SmartCal](#) selection. Both selections require that you already have TRL calibration standards defined and included in a VNA cal kit.

1. Preset the VNA
2. Set up a measurement and the desired stimulus settings.
3. Click **Cal** > **Other Cals** > **Smart Cal...**

4. [Select the DUT connectors and Cal Kit](#) for each port. The LOWEST port number of each [port pair](#) MUST include TRL standards. TRL appears as the Cal Method.
5. Check **Modify Cal, Next**, then **View/Modify** to change [default TRL options](#) if necessary.
6. Follow the prompts to complete the calibration.
7. [Check the accuracy](#) of the calibration

TRL Cal Kits

Keysight Technologies offers two cal kits that include the required standards to perform a TRL calibration: 85050C (APC 7mm) and 85052C (3.5mm). Both kits include the traditional Short, Open, and Load standards. (The Thru standard, not actually supplied, assumes a [zero-length Thru](#)). In addition, the kits include an airline which is used as the LINE standard. To use the airline, the kits include an airline body, center conductor, and insertion / extraction tools. The APC 7 kit includes an adapter to connect the airline to the APC connector.

Cal Standards Used in TRL

These standards must be defined in your TRL cal kit:

THRU

Note: All [THRU calibration methods](#) are supported in a TRL Cal **EXCEPT** Unknown Thru.

- The THRU standard can be either a zero-length or non-zero length. However, a zero-length THRU is more accurate because it has zero loss and no reflections, by definition.
- The THRU standard cannot be the same electrical length as the LINE standard.
- If the insertion phase and electrical length are well-defined, the THRU standard may be used to [set the reference plane](#).
- Characteristic impedance of the THRU and LINE standards defines the reference impedance of the calibration.
- If a THRU standard with the correct connectors is NOT available, an adapter removal cal can be performed.

REFLECT

- The REFLECT standard can be anything with a high reflection, as long as it is the same when connected to both VNA ports.
- The actual magnitude of the reflection need not be known.
- The phase of the reflection standard must be known within 1/4 wavelength.
- If the magnitude and phase of the reflection standard are well-defined, the standard may be used to [set the reference plane](#).

LINE

The LINE and THRU standards establish the reference impedance for the measurement after the calibration is completed. TRL calibration is limited by the following restrictions of the LINE standard:

- Must be of the same impedance and propagation constant as the THRU standard.
- The electrical length need only be specified within 1/4 wavelength.
- Cannot be the same length as the THRU standard.
- A TRL cal with broad frequency coverage requires multiple LINE standards. For example, a span from 2 GHz to 26 GHz requires two line standards.
- Must be an appropriate electrical length for the frequency range: at each frequency, the phase difference between the THRU and the LINE should be greater than 20 degrees and less than 160 degrees. This means in practice that a single LINE standard is only usable over an 8:1 frequency

range (Frequency Span / Start Frequency). Therefore, for broad frequency coverage, multiple lines are required.

- At low frequencies, the LINE standard can become too long for practical use. The optimal length of the LINE standard is 1/4 wavelength at the geometric mean of the frequency span (square root of $f_1 \times f_2$).

Note: The TRL LINE standard must have a delay that is greater than 0 (zero) ps. Otherwise, calibration correction calculations will contain unpredictable results.

MATCH

If the LINE standard of appropriate length or loss cannot be fabricated, a MATCH standard may be used instead of the LINE.

- The MATCH standard is a low-reflection termination connected to both Port 1 and Port 2.
- The MATCH standard may be defined as an infinite length transmission line OR as a 1-port low reflect termination, such as a load.
- When defined as an infinite length transmission line, both test ports must be terminated by a MATCH standard at the same time. When defined as a 1-port load standard, the loads are measured separately. The loads are assumed to have the same characteristics.
- The impedance of the MATCH standard becomes the reference impedance for the measurement. For best results, use the same load on both ports. The load may be defined using the data-based definition, the arbitrary impedance definition, or the fixed load definition.

See Also

- See [Modify Calibration Kits](#) for detailed information about creating and modifying Calibration kit definitions.



TRL with an External Test Set

TRL CAN be performed with an External Test Set enabled. Previously, a TRL calibration required a VNA with a reference receiver for each test port. With the new TRL method, a Delta Match Calibration is first performed and applied.

Note: See Delta Match Calibration to learn which models require this.

The accuracy of this TRL cal greatly depends on the accuracy of the Delta Match Calibration. With an accurate Delta Match Calibration, the difference in accuracy between a traditional TRL cal and this TRL cal is negligible.

How to Perform a TRL Cal in these cases

1. Click **Cal** > **Other Cals** > **Smart Cal...** .
2. Select a TRL cal kit for the ports to be calibrated.
3. During the calibration, the Cal Wizard prompts you for a [valid Delta Match Cal.](#)

Last modified:

2-Sep-2014 First Release

Power Calibration

Source and Receiver Power Calibrations work together to provide very accurate power levels from the source, and very accurate power measurements from the VNA receivers.

- [Source Power Calibration Overview](#)
- [Supported Power Meters and Sensors](#)
- [How to perform Source Power Calibration](#)
- [Setup](#)
- [Source Power Cal dialog](#)
- [Saving a Source Power Calibration](#)
- [Reducing Time to Complete a Source Power Calibration](#)
- [Receiver Power Calibration](#)
- [Saving Receiver Cals](#)

Other Source Power Cal choices

- **Guided Power Cal** can be performed during an S-parameter Guided Calibration. [Learn more.](#)
- **Receiver Leveling** can be used to provide 'real-time' source power cal. [Learn more.](#)
- **See Also:** [Configure an Power Meter As a Receiver \(PMAR\)](#)

See other Calibration Topics

Source Power Calibration Overview

Perform Source Power Calibration when you need accurate power levels at some point in the measurement path between the VNA test ports. For example, you need to characterize the gain of an amplifier across a frequency range at a specified input power. You would perform a source power cal at the input of the amplifier to ensure the **exact** power level into the amplifier across the frequency range.

Using a Source Power Cal, you can expect the power at the point of calibration to be within the range of the uncertainty of the power meter and sensor that is used.

Source Power Calibration...

- Is independent of measurement type. It corrects the VNA source regardless of which receivers are being used in a measurement. Therefore, it can be used with both [ratio or non-ratio measurements](#).
- Applies **ONLY** to those measurements on the selected channel that use the test port that was [specified as the Source](#) for the calibration. For example, if you specify Channel 1 and Port 1 as the source to be calibrated, only those measurements on channel 1 that use port 1 as the source will be corrected.
- Can be used in conjunction with other measurement calibrations, such as a full 2-port calibration. For highest accuracy, perform the measurement calibration **AFTER** the source calibration.
- Can be used with [Power Sweep](#) type. Source Power Cal will correct the power at all power levels across the power sweep.

- Can be used with [Port Power Uncoupled](#).
- Forces [sweep mode to Stepped](#) on measurements with source power correction turned ON.
- An external source can be calibrated using Source Power Cal.

Overview of How it works:

See Important First-time USB connection note.

[Click to see the detailed procedure](#)

1. Specify the measurement settings (frequency range, IFBW and so forth).
2. Start Source Power Calibration.

Note: When using an 848X power sensor (sensors that do NOT have built-in calibration factors), enter the Cal Factors using the [Power Sensor Settings](#) dialog, because the VNA instructs the power meter to NOT use the Cal Factor tables internal to the power meter.

3. Connect a power meter sensor to the point at which you want a known power level. This may be at the input or output of your device, or some other point between the test ports.
4. The VNA source is stepped through the specified frequency range, and power is measured with the power meter. At each data point, the source power is adjusted until the measured power is within your specified accuracy level.
5. When complete, the power meter is preset. The source power calibration can be [saved as part of the instrument state](#).
6. The power meter is removed and the measurement path reconnected.
7. The calibration is automatically applied to the channel. All measurements on that channel using that source port benefit from the source power cal.
8. Perform an S-parameter calibration AFTER a Source Power Cal. The S-parameter cal is performed using the corrected stimulus power levels for the relevant ports.

Verify the source power calibration using the following procedure.

1. Connect the power meter as it was during the source power calibration.
2. Set the VNA to [Point Trigger](#) mode.
3. Trigger the VNA across the trace. Read about the behavior of the [sweep indicator](#).
4. At each data point, the power meter should read the corrected power level within the specified tolerance.

Supported Power Meters and Sensors

[See Keysight's Power Meters and Sensors Webpage.](#)

USB Power Sensors

- U848x Series USB Thermocouple Power Sensors
 - These include the following models: U8481A, U8485A, U8487A, U8488A
- U2020 X-Series USB Peak and Average Power Sensors.
 - These include the following models: U2021XA, U2022XA
 - The VNA does NOT support peak mode in these sensors, but measures average power.
- U2000 Series USB power sensors.
 - These include the following models: U2000A, U2000B, U2000H, U2001A, U2001B, U2001H, U2002A, U2002H, U2004A

USB Notes:

- From a standard power cal (this topic), only one USB power sensor can be used to cover the entire frequency span. To use multiple power sensors, perform a Guided Power Cal. [Learn how.](#)
- To select a USB power sensor for a standard power cal:
 1. Connect the sensor directly to one of the VNA USB ports.
 2. From the [Source Power Cal](#) dialog, click **Power Meter Config**.
 3. On the [Power Meter Settings](#) dialog, select **USB**.
- See Important First-time USB connection note.
- See note about [Zeroing USB Power Sensors](#).
- See also: [Power Meters as Receivers](#) (PMAR)

Power Meters

- P Series power meters (N1911A, N1912A, N1921A, N1922A) and all supported sensors.
- EPM Series power meters (N1913A and N1914A) and all supported sensors.
- EPM-P Series power meters (E4416A and E4417A) and all supported sensors.
- EPM-441A and EPM-442A Series power meters and all supporting sensors.
- E Series power meters (E4412A, E4413A, E4418A, E4418B, E4419A, E4419B, E9300A, E9301A, E9304A, E9304A-H18, E9304A-H20, E9300H, E9304A-H19, E9301H, E9300B and E9301B) and all supported sensors.
- HP 437B / 438A power meters.
- ECP-E18A power meters.
- 8482A power meters.

Power Meter Notes:

- N1911A, 12A, 13A, and 14A power meters have a **device-side USB connector**  and are controlled by the VNA exactly like a USB sensor. See [USB Power Sensors](#) (above). Although these meters may also have a front-panel USB port, USB power sensors must be connected directly to one of the VNA USB ports.
- Source Power Calibration operates slowly with the Keysight E930x and E932x power sensors.
- Some Keysight power meters have a mode that emulates the command set of the 437B or 438A power meter. The VNA does NOT support this emulation mode.
- The [82357B USB/GPIB Interface](#) can be used to control power meters.
- Create a Custom Power Meter Driver for use with other power meters.

How to perform Source Power Calibration

Note: n Guided Power Cal can be performed during an S-parameter Guided Calibration. [Learn more.](#)

1. Setup your measurement (sweep type, frequency range, IFBW, and so forth). By default, a Source Power Cal is performed on the source port of the active measurement.
2. Connect coax cable, GPIB cable, and power sensors to the VNA as shown in graphic below.

This image does NOT apply to USB power sensors, which are connected directly to a VNA USB port.

See Important First-time USB connection note.

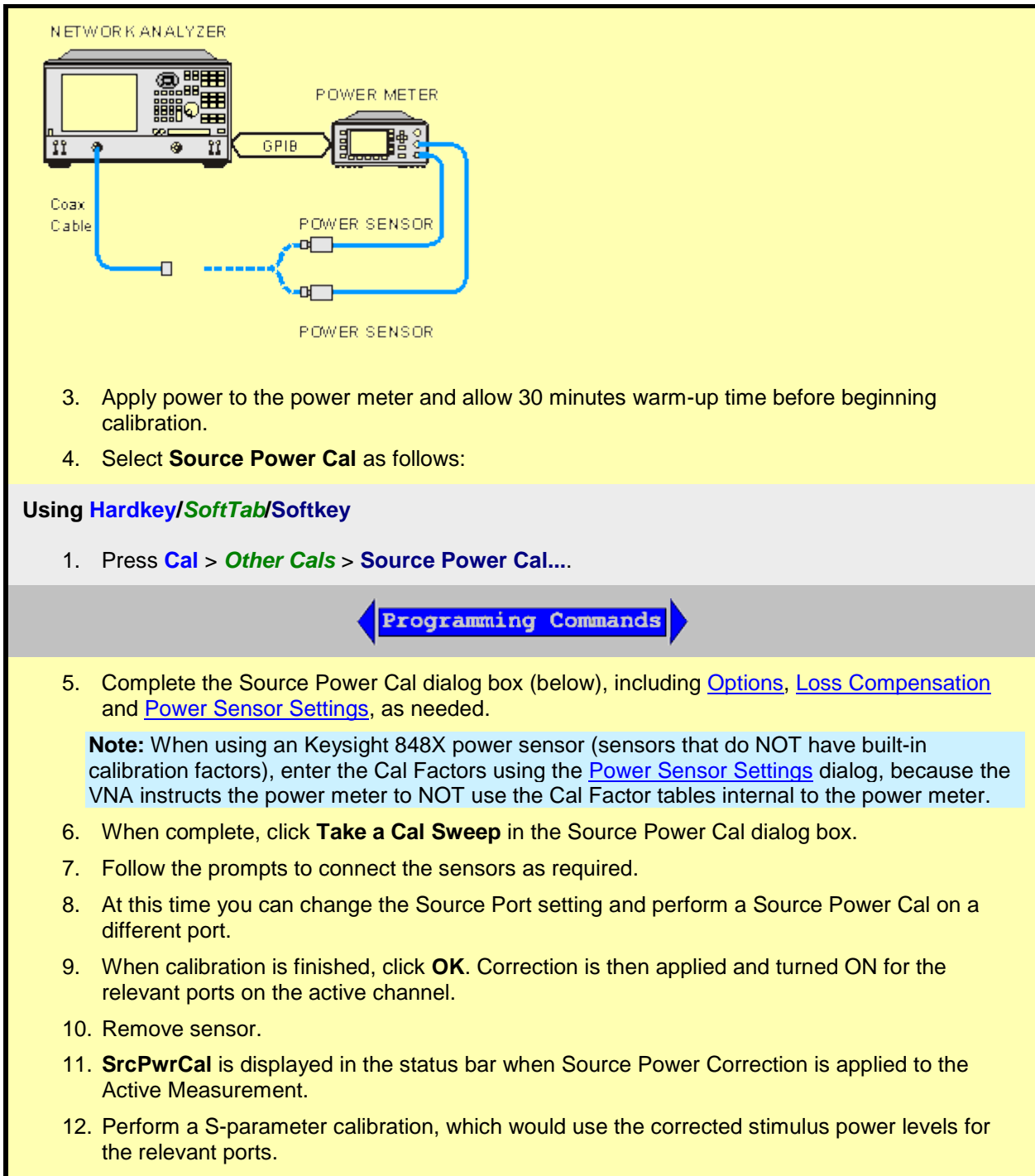

To turn Source Power Correction OFF:

- **Cal** > **Other Cals** > **Source Power Cal...** and turn it OFF.
- ONLY correction for the source port of the ACTIVE MEASUREMENT is turned OFF (regardless of [port power coupling setting](#).)

Interpolation or Extrapolation

If the original stimulus settings are changed, Interpolation or EXTRAPOLATION is applied and **SrcPwrCal*** is displayed in the status bar. This is different from [measurement calibration interpolation](#). For example, if the frequency span is increased, the VNA will extrapolate new correction values rather than turn correction off. This is to protect your test device from being overpowered by the source. If the original settings are restored, then source power calibration returns to full correction.

Source Power Cal dialog box help

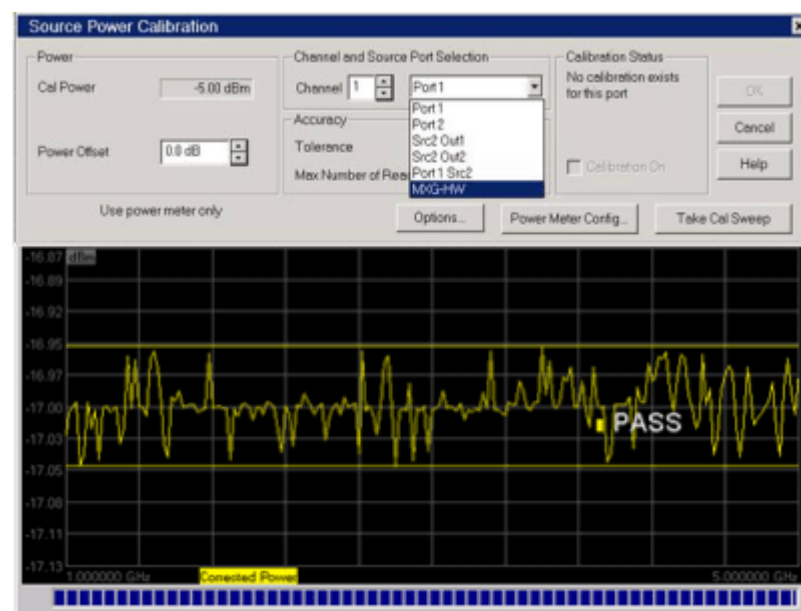

Note: Be sure that the frequency range of your power sensor covers the frequency range of your measurement. This does NOT occur automatically.

Power

Cal Power The calculated power (in dBm) at the calibration point. This value is the specified VNA source power plus the Power Offset value.

Power Offset Allows you to specify a gain or loss (in dB) to account for components you connect between the source and the reference plane of your measurement. These components will remain during a measurement. For example, specify 10 dB to account for a 10 dB amplifier in the path to your DUT. Following the calibration, the VNA power readouts are adjusted to this value.

To account for components that will be removed when the calibration is complete, use the [Loss Compensation table](#).

Channel and Port Selection

Channel Specifies the channel on which to perform the calibration. This setting defaults to the active channel.

Source Port Specifies the source port to be corrected. This setting defaults to the source port for the active measurement.

Accuracy

At each data point, power is measured using the [specified Power Meter Settling Tolerance](#), then adjusted until the reading is within this Accuracy **Tolerance** or the **Max Number of Readings** has been met. The **last** power reading is plotted on the screen against the Tolerance limit lines.

Tolerance Sets the maximum desired deviation from the specified **Cal Power** level in 0.005 dB increments from 0 to 5 dB.

Max Number of Readings Sets the maximum number of readings to take at each data point for

iterating the source power. Enter a value between 1 and 1000.

Calibration Status

Allows you to turn Source Power Cal ON | OFF and view Cal data for each port, regardless of the active measurement. This feature allows the Internal Second Source to be calibrated and turned ON | OFF, even when being used as an incidental source in a measurement, such as an LO.

Calibration ON Check to turn Source Power Calibration ON for the specified source port.

The displayed text indicates when [interpolation](#) is applied for the calibration.

Buttons

Options Invokes the [Source Power Cal Options](#) dialog. Label to the left of the button displays the current 'Options' setting.

Power Meter Config Invokes the [Power Meter Settings](#) dialog box

Take Cal Sweep Begins source power calibration measurement.

OK Applies calibration. This button is disabled until the Take Cal Sweep has been pressed.

Cancel If a sweep is in progress, cancels the sweep. Press again to close the dialog.

Note: the power meter is operating in 200 r/s mode.

During a measurement, some power meters may display this message on the screen: It means that the meter is operating in 200 readings/sec which is the fastest speed setting for this meter. This is normal operation.

Pass / Fail Limits

Limit lines are drawn on the Source Power Cal measurement graticule area. These lines are at the Cal Power +/- the current setting of Accuracy Tolerance. A FAIL during the Source Power Cal sweep means that the VNA was unable to measure power to within the Accuracy Tolerance. Tight tolerances are more difficult to achieve at lower Cal Power levels. When a FAIL indication appears, increase the Max Number of Readings. If this does not cause a PASS condition, then decrease the Accuracy Tolerance value.

See Also

- Learn more about [Source Power Cal](#)
- Learn about External Testsets and Source Power Cal.

Source Power Calibration Options dialog box help

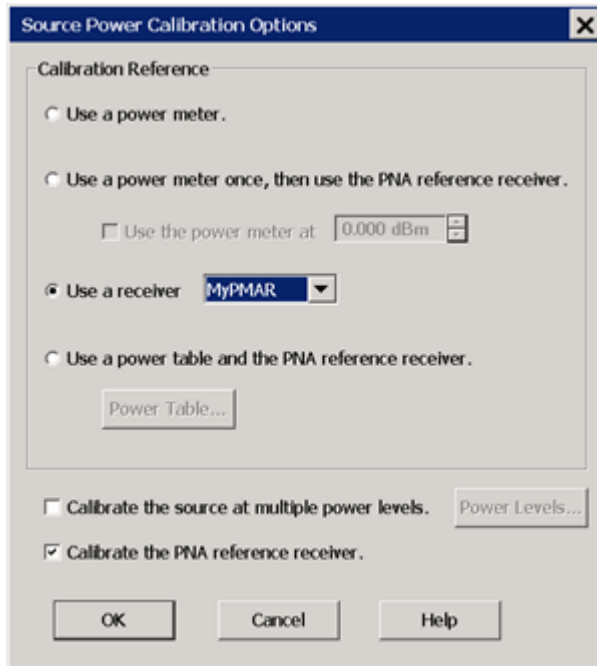

Provides options for measurement of the source power.

Note: At low power levels (less than -30 dBm) most power meters are not as accurate as a VNA receiver.

Calibration Reference Choose power meter/VNA receiver to use to measure power.

- **Use a power meter.** Traditional source power calibration using only a power meter to measure the source power at each data point. Most accurate (at higher power levels) and slowest method.

Note: Because the following two settings use VNA receivers to make power measurements, they do NOT work correctly when a Frequency Offset value is being used.

- **Use a power meter once, then use the VNA reference receiver.** When checked, the first reading at each data point uses a power meter to calibrate the reference receiver. Subsequent readings, if necessary to meet your accuracy requirement, are measured using the reference receiver. This technique is much faster than using the power meter, and more accurate when measuring low power levels.

Note: Do NOT use this setting if there is a component before the power sensor that exhibits non-linear behavior, such as a power amplifier in compression. Use a power meter and [Calibrate the source at multiple power levels.](#)

- **Use a receiver.** Select a VNA Receiver or a PMAR (Power Meter as Receiver).

VNA receiver - For highest accuracy, first calibrate the receiver by performing a source power cal using a power meter, then a [receiver cal](#). That receiver can then be used to quickly calibrate other VNA source ports, or used on another channel with different stimulus settings. This would be useful, for example, if the power level of the measurement was below the sensitivity of the power sensor. Calibrate the VNA receiver using a source power cal that is within the sensitivity of the sensor. Then, use the calibrated receiver to perform a second source power cal at the reduced power level.

- The VNA receiver is specified using either standard receiver notation or [logical receiver notation](#).
- It is best to use the reference receiver for the source port to be calibrated. For

example, if calibrating source port 2, specify "R2" or "a2" which is the same port 2 reference receiver using [logical receiver notation](#).

- To ensure an accurate source power cal, the frequency range over which the receiver was calibrated must be the same or larger than the "receiver only" source power calibration.
- All accuracy and settling tolerance and number of reading settings apply just as they do with a power meter reading.

PMAR Device - The power meter/sensor must first be configured. [Learn how to Configure a PMAR device](#).

- **Use a power table and the VNA reference receiver** Used to provide power leveling with mmWave test set and modules. [Learn more](#).

Calibrate the source at multiple power levels Used primarily with mmWave measurements.

This feature can also be used with standard VNA measurements when a component is used in the source path such as a booster amp which does NOT have linear gain or loss over frequency. If this is not true for your setup but want to improve your source power accuracy, consider using the Receiver Leveling feature.

When checked, source power is measured using the specified 'Cal Reference' device (power meter/sensor or VNA receiver) and iterated on a sweep-to-sweep basis to construct a 2-dimensional power table: Power IN, Power OUT, over all frequencies.

- Click **Power Levels** to launch the [Source Cal Power Levels dialog box](#) to set the power levels at which source power is to be measured.
- The source power cal is saved, but the power table is NOT accessible.

Calibrate the VNA reference receiver Check to calibrate the appropriate reference receiver to the power level that is measured at the calibration plane. Do this to make very accurate measurements using the calibrated reference receiver. This cal is done in addition to the standard source power cal using the any of the methods listed above. At the end of the source power cal measurement sweep, you can optionally save the reference receiver cal to a Cal Set to be recalled at a later time. The Cal is saved when the **OK** button is clicked to close the Source Power Cal dialog.

Source Cal Power Levels dialog box help



This dialog appears when you click **Power Levels** on the [Source Power Cal Options dialog](#).

Specify the power levels at which the Source Power will be calibrated. These values should be set to a few dB more or less than the measurement power levels.

Max Power - The highest power level at which to calibrate. This value should be a few dB **higher** than the highest power level of your measurement.

Min Power - The lowest power level at which to calibrate. This value should be a few dB **lower** than the lowest power level of your measurement.

Power Step - Calibrate at every incremental power level, between the Max and Min Power settings.

Power Meter Settings dialog box help

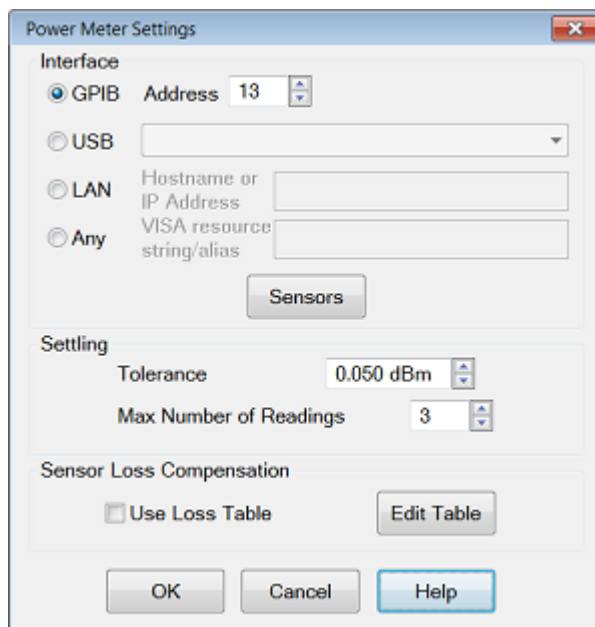

This dialog appears when you click the Power Meter Config button on many dialog boxes.

Interface

- **GPIB / Address** Select GPIB power meter. Then select the address for the power meter. Default is 13. The VNA will search VISA interfaces that are configured in the Keysight IO Libraries on the VNA. Note: Use this selection when using a [82357B USB/GPIB Interface](#),
- **USB** VNA scans for USB power sensors or [N191x device-side USB power meters](#). Select a power sensor from the list. Only ONE USB power sensor can be configured to cover the entire frequency range of the calibration. To use multiple power sensors, perform a [Guided Power Cal.](#)
- **LAN** Specify the Hostname or IP address of the Power Meter.
- **Any** For future use.

Sensors Invokes the [power sensor settings](#) dialog box.

Settling

These Settling settings do not apply when a VNA receiver is the power measurement device. Each power meter reading is "settled" when either:

- two consecutive meter readings are within this Tolerance value or
- when the Max Number of Readings has been met.

The readings that were taken are averaged together to become the "settled" reading. The settled reading is then compared to the [Accuracy Tolerance requirements](#) (tolerance and max readings)

specified on the Source Power Cal dialog box.

Tolerance When consecutive power meter readings are within this value of each other, then the reading is considered settled.

Max Number of Readings Sets the maximum number of readings the power meter will take to achieve settling.

Sensor Loss Compensation

Use Loss Table Select this checkbox to apply loss data to Source Power calibration correction (such as for an adapter on the power sensor).

Edit Table Invokes the [Power Loss Compensation](#) dialog box.

Power Loss Compensation dialog box help

See [Power Loss Compensation Dialog Box Help](#).

Power Sensor Settings dialog box help

See [Power Sensor Setting Dialog box](#)

Saving a Source Power Calibration

Because Source Power Cal calibrates source hardware, the calibration data is saved as part of the **Instrument State**, in either a .csa file or a .cst file. This correction is applied to all measurements on the channel that uses the calibrated source. See [Save Instrument State](#).

Reducing Time to Complete a Source Power Calibration

The time required to perform a Source Power Calibration depends on source power, number of points, and number of readings taken. You can reduce this measurement time with the following methods:

- **Reduce number of points before calibration.** You can reduce the number of points before the measurement, then return the number of points to its original value after calibration is complete and correction is ON. The analyzer will perform a linear interpolation, although with some loss in accuracy.
- **Use an Keysight E-Series sensor.** You can obtain 40+ readings per second over GPIB with this type of sensor on the VNA.
- **Increase power to the sensor.** Lower power may have longer settling time with some sensors.
- **Check [Use Reference Receiver for Iteration](#).**

Receiver Power Calibration

Note: A Guided Power Cal can be performed during an S-parameter Guided Calibration. [Learn more](#).

Receiver power calibration mathematically removes frequency response errors in the specified VNA receiver, and adjusts readings to the same, or a value offset from, the source power calibration level. It is the same as doing a **Response Cal** or **Data / Memory, (Normalization)** but with the data shifted to the [Cal Power](#) value.

Use Receiver Power Calibration to make very accurate absolute power (amplitude) measurements.

Receiver Power Calibration:

- Is ONLY allowed when making absolute power ([unratioed](#)) measurements.
- Is most accurate when a source power calibration was performed first.
- Applies to all unratioed measurements in the active channel using that receiver.
- Can be saved in a Cal Set and later reapplied to a like measurement.

Interpolation

Like other calibration types, if the original stimulus settings are narrowed, interpolation is applied and **C*** is displayed in the status bar. If the original stimulus settings are made wider, the VNA will turn Receiver Power Correction **OFF**.

If the original settings are restored, then receiver power calibration returns to full correction.

How to perform a Receiver Power Calibration

1. Perform a [Source Power Calibration](#).
2. Set the active measurement to unratioed. [Learn How](#).
3. Connect a THRU line from the source port to the receiver port.
 - When performing a receiver power cal on a reference receiver (source 1 and receiver R1), no connection is necessary as the receiver is internally connected to the source.
 - When the source port and receiver port are the same (receiver A, source port 1), then connect an open or short to get maximum power to the receiver. This practice is not recommended. It is best to use different ports for the source and receiver.
4. Ensure correction for Source Power Calibration is ON as indicated by **Src Pwr Cal** or **Src Pwr Cal*** in the status bar.
5. Start the [Calibration Wizard](#)

Using Hardkey/SoftTab/Softkey

1. Set the active measurement to unratioed. [Learn How](#).
2. Press **Cal** > **Other Cals** > **Receiver Power Cal...**

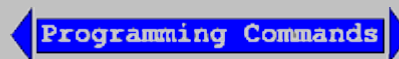

Select Calibration Type for Unratioed Measurement dialog box help

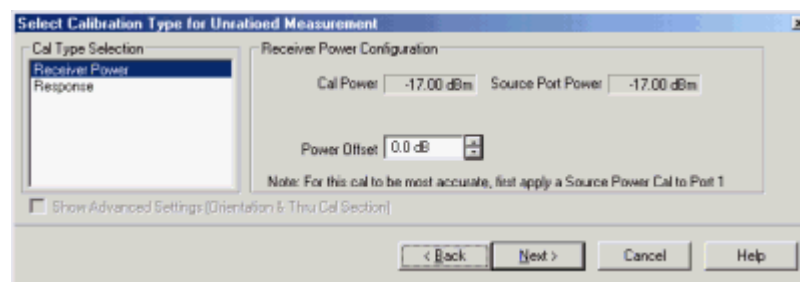

Cal Type Selection Select **Receiver Power**

Receiver Power Configuration

Cal Power Specifies the power level to be displayed on the measurement when complete. (Source Port Power + Power Offset).

Source Port Power Test port Power set for the measurement. [Learn how to change Test Port Power](#)

Power Offset Allows you to specify a gain or loss (in dB) to account for components you connect between the source and the reference plane of your measurement AFTER a source power cal has been performed. Following the calibration, the VNA power readouts are adjusted to the Cal Power value.

Next Click to continue the Calibration Wizard.

Notes:

- When Receiver Power Cal is finished, **'Response'** is displayed in the status bar and correction data is applied to subsequent sweeps. This is done because Receiver Power Cals are essentially Response Cals once they are stored and applied. See Saving a Receiver Power Cal below.
- To turn correction **OFF**, click **Cal > Main > Correction > Channel Correction OFF**.

[Learn more about Receiver Power Cal \(scroll up\).](#)

Saving a Receiver Power Calibration

Receiver Power Cal is saved to a [Cal Register](#) and optionally to a [User Cal Set](#). It can be applied to measurements in the same way as other Cal Types. Previously, Receiver Power Cal data was saved as part of an Instrument State and was only applied to the measurement on which it was performed.

[Learn more about Saving VNA files types.](#)

Last modified:

29-Sep-2015 First Release



Fixture Simulator

The following features allow you to mathematically add (embed) or remove (de-embed) circuits to, or from, your VNA measurements. The mathematical models are applied to specific ports for all measurements on the channel.

Notes

- The following features are available
 - [Port Extensions](#)
 - [2 Port De-embedding](#)
 - [Port Matching](#)
 - [Port Z Conversion](#)
- All other fixturing features are available ONLY in a [standard class](#).
- When fixturing is enabled, all of the enabled fixturing features are applied when [snp files are saved](#).

See Also

- **Procedures: To Embed or De-embed?**
- Characterize Adaptor Macro can be used to create S2P files from Cal Sets.
- ["De-embedding and Embedding S-Parameter Networks Using a Vector Network Analyzer" App note](#). for more conceptual information on Fixture Simulation.
- [See an example](#) of how these functions can be used to de-embed unwanted effects of a test fixture, and then mathematically embed the DUT in the circuit in which it is used.

Order of Fixture Operations

First, the following **Single-ended** measurement functions are processed in this order:

1. [Port Extensions](#)
2. [2-Port De-embedding](#)
3. [Port Matching Circuit Embedding](#)
4. [Port Z \(Impedance\) Conversion](#)
5. [4/6/8-Port Network \(single-ended\) Embed/De-embed](#)

Then, **Balanced** measurement functions are processed in this order:

6. [Balanced Conversion](#)
 7. [Differential / Common Mode](#) Port Z Conversion
 8. [Differential Matching Circuit Embedding](#)
- [Source power compensation](#) is then optionally applied to compensate for the aggregate loss through all enabled fixturing operations.

Notes

- The fixturing operations are applied to the measurement results.

- The order of operations 1 through 4 can be changed using the SCPI command: CALC:FSIM:SEND:OORD. Learn how to send this command from the [GPIB Command Processor Console](#).
- The order of the operations 5 through 8 can NOT be changed.
- In the VNA data processing chain, the Fixture Simulator functions occur at the same time as the **Apply Error Terms** block.

How to select Fixturing Simulator About Fixture Simulator ON/off

BOTH of the following must be required to turn a fixturing selection **ON**.

1. Turn **Apply Fixtures ON**
Port Extensions is NOT affected by fixturing ON/off.
2. Check **Enable** on the individual fixturing selection dialog box.

Using **Hardkey/SoftTab/Softkey**

1. Press **Cal** > **Fixture Match** > **Apply Fixtures**

Or

1. Press **Cal** > **Fixtures** > **Apply Fixtures**

◀ **Programming Commands** ▶

Port Matching dialog box help

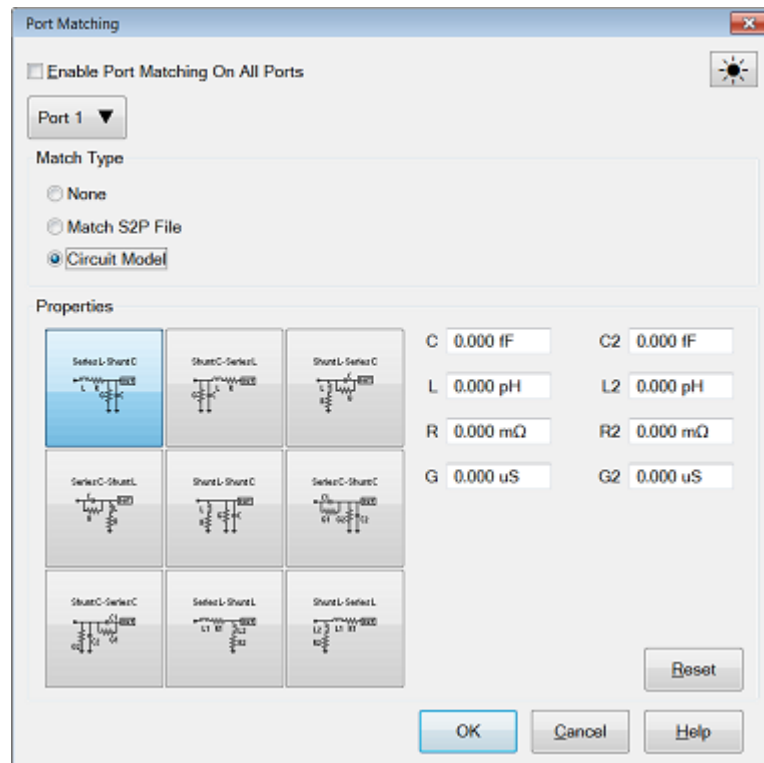

This function specifies a circuit to embed (add) to the measurement results. [See Order of Fixture](#)

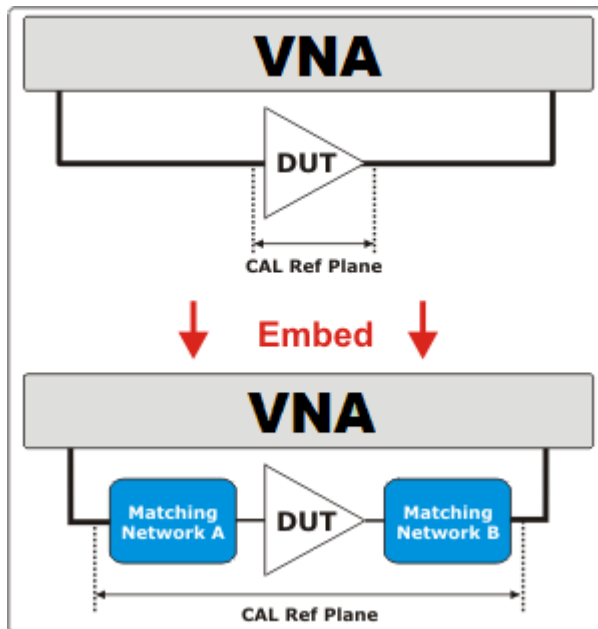
Operations.

Enable Port Matching Check to apply the settings to the measurement results. Must also enable [Fixturing ON/OFF](#).

Port - Select Port in which to apply simulation.

Circuit Model for Matching - Choose one of circuit model to emulates your fixture at the selected VNA port:

User S2P File Click to specify an S2P file of the circuit model to embed at the selected port. If the normalized impedance value in a recalled User .S2P file is different from the port reference impedance setting of the VNA, the VNA setting is used. Characterize Adaptor Macro can be used to create S2P files from Cal Sets.

Circuit Values

Capacitance (C), Inductance(L), Resistance(R), Conductance(G) Values for the specific components of the circuit type that models your fixture.

Reset Restores the default values.

2 Port De-embedding dialog box help

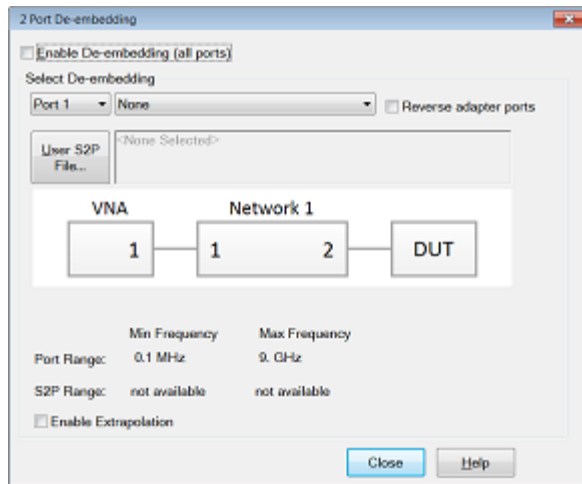

De-Embed when you have performed a calibration and then added a fixture (an adapter, an attenuator, a longer cable, etc.) that connects between the Cal reference plane and your DUT. This function **removes** the effects of a component or test fixture from the measurement results.

Note: De-embedding a component with more than 20 dB of loss becomes impractical because of an inability to accurately measure the match of the DUT through such a device.

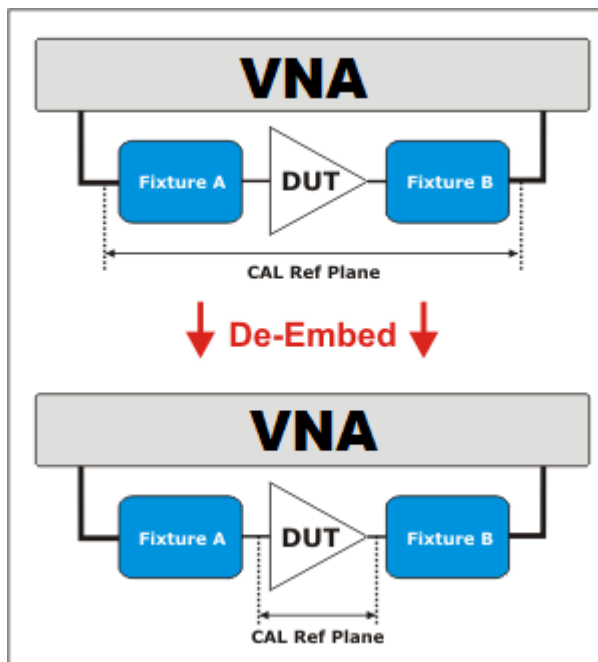

The de-embedding operation recalls an .s2p file (Touchstone format) which includes the electrical characteristics of a 2-port fixture or device. The file can be in any standard format (real-imaginary, magnitude-angle, dB-angle).

Enable De-embedding Check to apply the settings to the measurement results. Must also enable [Fixturing ON/off](#).

Enable Extrapolation Check to apply a simple extrapolation when the S2P file has a narrower frequency range than the channel. The values for the first and last data points are extended in either direction to cover the frequency range of the measurement. The frequency ranges of both the channel and the S2P file are displayed at the bottom of the dialog.

When extrapolation is necessary and enabled, a message is displayed showing the frequency range

to be extrapolated. When extrapolation is necessary and disabled, a message is displayed offering to enable extrapolation.

This setting also causes [4/6/8-port Extrapolation](#) to be enabled and disabled.

Port The VNA port to which the recalled de-embedding file is applied.

From the drop-down menu, select **User Defined (S2P File)**.

Reverse Adaptor Ports Check to cause the Fixture/Adapter to be configured with Port 2 connected to the VNA and Port 1 to be connected to the DUT. The image in the dialog reflects that change.

User S2P File Click to specify an existing .S2P file. If the normalized impedance value in a recalled User .S2P file is different from the port reference impedance setting of the VNA, the VNA setting is used. Characterize Adaptor Macro can be used to create S2P files from Cal Sets.

Port Z (Impedance) Conversion dialog box help

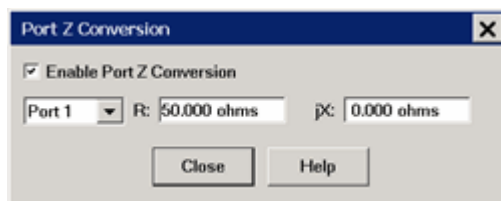

Note: This feature is available to the following SMC and standard (S-Parameter) channels.

This function corrects the measurement and displays the results as if the measurement had been made into the specified impedance value. However, the physical port termination is still approximately 50 ohms.

The specified impedance value is applied to all of the measurements on ONLY the active channel.

[See Order of Fixture Operations.](#)

Enable Port Z Conversion Check to apply the settings to the measurement results. Must also enable [Fixturing ON/off](#).

R Real part of the impedance value.

jX Imaginary part of the impedance value.

Close Applies the entries and closes the dialog box

Note: Port Z (Impedance) conversion uses values in the following prioritized order:

1. Balanced ([Differential](#) or [Common Mode](#)) - if enabled, these values are always used.
2. [Single Port Impedance](#) - if enabled, this value is used if Balanced is not enabled.
3. [System Impedance](#) - if neither balanced or single port is enabled, this value is used.

4/6/8-Port Embed/De-embed dialog box help

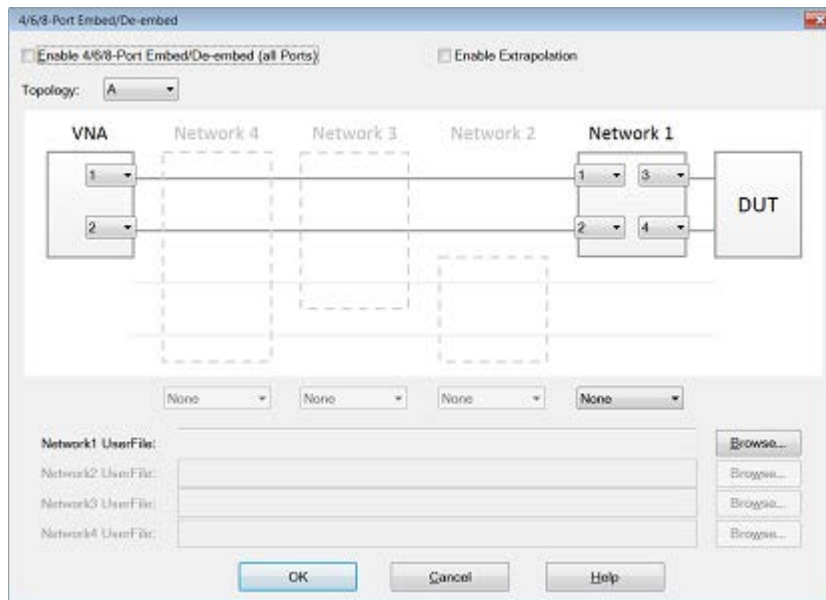

This function specifies a single-ended 4/6/8-port circuit (*.SnP file) to embed (add) or de-embed (remove) from the measurement results. Computation takes place BEFORE Balanced conversion. [See Order of Fixture Operations.](#)

There is a single normalized impedance value for each port in the *.SnP file. This impedance value must match the impedance of the previous Port Z setting, or the VNA port impedance.

The VNA will interpolate if the number of data points that are read is different from the current VNA setting.

Enable 4/6/8-Port Embed/De-embed Check to apply the settings to the measurement results. Must also enable [Fixturing ON/off](#).

Enable Extrapolation Check to apply a simple extrapolation when the SnP file has a narrower frequency range than the channel. The values for the first and last data points are extended in either direction to cover the frequency range of the measurement. The frequency ranges of both the channel and the SnP file are displayed at the bottom of the dialog.

When extrapolation is necessary and enabled, a message is displayed showing the frequency range to be extrapolated. When extrapolation is necessary and disabled, a message is displayed offering to enable extrapolation.

This setting also causes [2-port Extrapolation](#) to be enabled and disabled.

Topology

Select a DUT topology. Refer to the images on the 4/6/8-port embed/De-embed dialog box.

- **A** - Network 1
- **B** - Network 1/3
- **C** - Network 1/2/4

NA Ports - Select the VNA Port that is connected to each circuit port.

Network Ports Select the network ports that represent the configuration of the *.S4P, *.S6P, or *.S8P file.

None, Embed, De-embed For Network1 and Network2, select:

- **None** - The same as disabling.

- **Embed** - Add the specified network circuit to the measurement results. [See 2-port Embed image.](#)
- **De-embed** - Remove the specified network circuit from the measurement results. [See 2-port De-embed image.](#)

Browse For all the network option - Network1, Network2, Network 3 and Network 4, navigate to find the *.S4P file to embed or de-embed.

OK Applies the changes and closes the dialog box.

Cancel Does NOT apply the changes and closes the dialog box.

Differential Impedance Conversion dialog box help

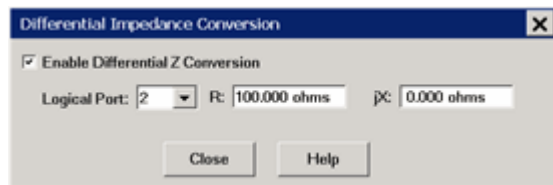

This function sets the Differential impedance value for each balanced port.

The default value for **R**: is the SUM of the impedance values for both ports that make the logical port. If [Port Z Conversion](#) is not enabled, then [System Z0](#) values for both ports are summed.

[See Order of Fixture Operations.](#)

Enable Differential Z Conversion Check to apply the settings to the measurement results. Must also enable [Fixturing ON/off](#).

Logical Port Select the logical (balanced) port to receive impedance value. To see logical port numbers, see the [measurement topology](#).

R Real part of the impedance value.

jX Imaginary part of the impedance value.

Close Closes the dialog box.

[See note about Port Impedance priority.](#)

Common Mode Impedance Conversion dialog box help

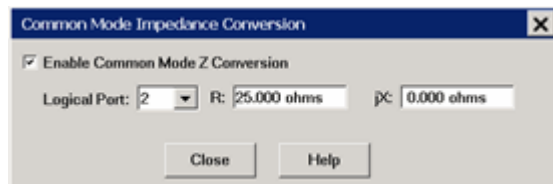

This function sets Common Mode Impedance value for each balanced port.

The default value for **R**: is calculated as follows.

$$(Z1 * Z2) / (Z1 + Z2)$$

Where ports 1 and 2 comprise the logical port:

Z1 = the Port Impedance values for port 1

Z2 = the Port Impedance values for port 2

If [Port Z Conversion](#) is not enabled, then [System Z0](#) values for port 1 and 2 are used in the calculation.

[See Order of Fixture Operations.](#)

Enable Common Mode Z Conversion Check to apply the settings to the measurement results. Must also enable [Fixturing ON/off](#).

Logical Port Select the logical (balanced) port to receive impedance value. To see logical port numbers, see the [measurement topology](#).

R Real part of the impedance value.

jX Imaginary part of the impedance value.

Close Closes the dialog box.

[See note about Port Impedance priority.](#)

Differential Port Matching dialog box help

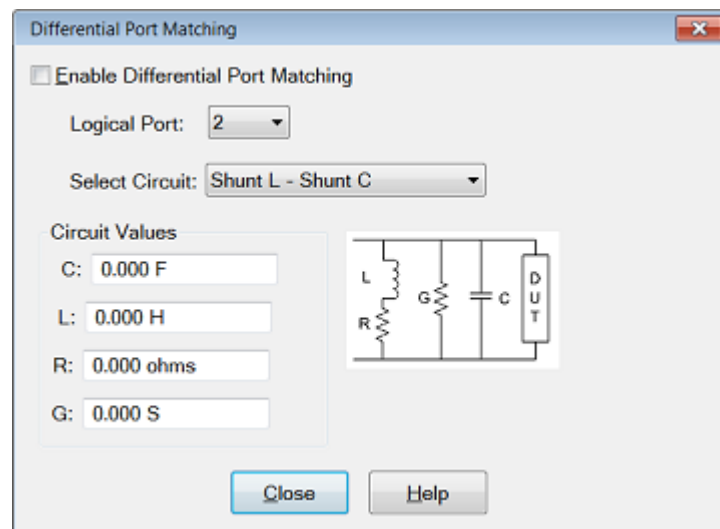

This function allows the embedding of a differential matching circuit at a balanced port.

[See Order of Fixture Operations.](#)

Enable Differential Port Matching Check to embed the selected matching circuit to the measurement results. Must also enable [Fixturing ON/off](#).

Logical Port Choose [Logical DUT port](#) to receive the selected matching circuit. To see logical port numbers, see the [measurement topology](#).

Select Circuit Select a matching circuit. Choose from:

- **Shunt L - Shunt C** Predefined circuit.

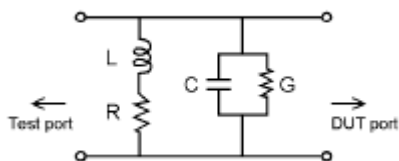

Circuit Values Choose from:

- **C** Capacitance value
- **G** Conductance value
- **L** Inductance value
- **R** Resistance value
- **User defined** Select an *.S2P file that represents the matching circuit. Then click **Browse** to navigate to the *.S2P file.

Note: For the *.S2P file:

Port 1 of the circuit is assumed to be connected to the VNA

Port 2 of the circuit is assumed to be connected to the DUT.

- **None** No embedded circuit on selected port.

Close Closes the dialog box.

Power Compensation dialog help

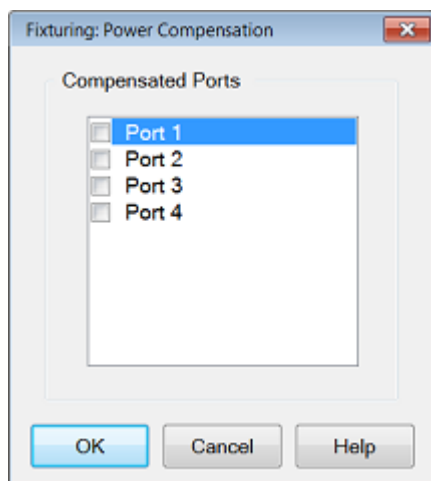

This function adjusts the source power at the specified port to compensate for the combined amount of gain or loss through ALL enabled fixturing operations. Use this function to set the power level at the DUT input.

For example:

- Your DUT requires a fixture on the input port which is connected to VNA port 1.
- The fixture description (such as an S2P file at the [2-port De-embed function](#)) indicates the fixture has approximately 2 dB of loss across the frequency span.
- You set source power to 0 dBm. But you want 0 dBm at the DUT input (the fixture output).
- Check Power Compensation on Port 1 and enable [Fixturing](#).
- Power Compensation causes the source power to be increased by approximately 2 dB so that the power at the fixture output plane will remain at 0 dBm.

Power Compensation affects all measurements in the channel.

Enable [Fixturing](#) to use Power Compensation.

Note: Use caution when applying power compensation. Always test your setup without a DUT in a place. If you are using S2P files, [Recall](#) your S2P file into the VNA so you can verify that the device

your S2P file describes is what you intended it to be. It is too easy to misalign data in S2P files if they are constructed by hand.

Fixture Simulator Example

The following example shows a DUT and the matching circuit with which the DUT will be used in its intended application. When the DUT is tested in a high-volume manufacturing environment, multiple test fixtures are often required. The most accurate way to test the DUT and ensure measurement consistency between the different test fixtures is to use a simple, repeatable, test fixture without the actual matching elements.

To get the desired performance data, the parasitic effects of the fixture must first be removed (de-embedded) from the measured data. Then a perfect "virtual" matching circuit must be simulated and added mathematically (embedded) to the corrected, measured data. The result is an accurate display of the DUT as though it was actually tested with a physical matching circuit, but without the uncertainties of using real components.

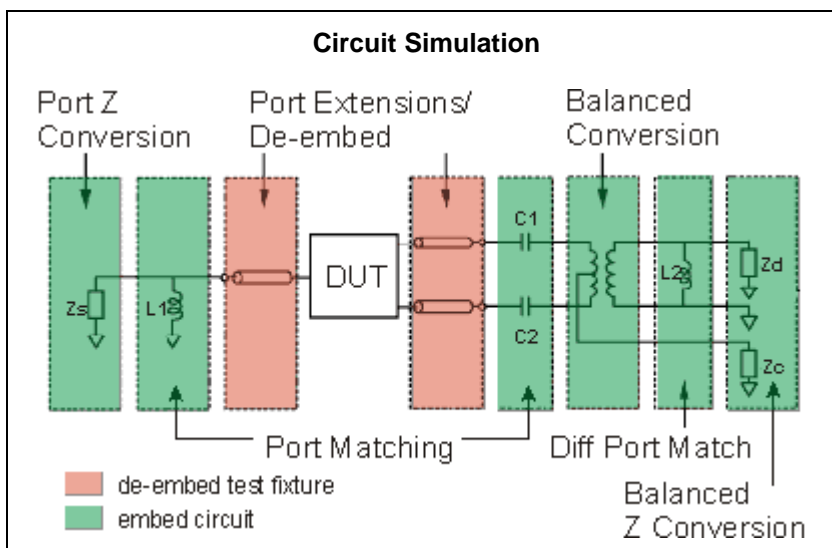
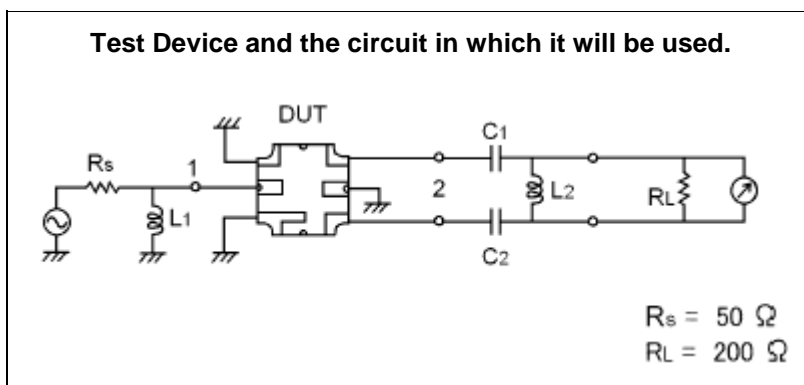

This diagram does NOT refer to the order in which operations are performed.

[See Order of Fixture Operations.](#)

1. [Create a balanced measurement](#) using single-ended to balanced (SE-Bal) [topology](#). Include all relevant measurement settings (IFBW, number of points, and so forth). Once the measurement is created and calibrated, the measurement parameter can be easily changed. For example, Sdd22 to Sds21.

2. Calibrate the measurement at the point where the simple test fixture is connected to the VNA. Use accurate calibration standards and definitions.
3. Remove the effects of the three uncalibrated transmission lines of the simple test fixture. This can be done in several different methods. The easiest is to use manual or automatic [Port Extensions](#) to move the calibration reference plane to the DUT. This removes the electrical length and loss of the fixture's transmission lines, but does not account for fixture mismatch. Another method is to de-embed previously-created *.S2p files of the 3 transmission lines. The files can be created using external ADS modeling software. Another alternative is to create the *.S2P files by independently measuring all 3 ports of the test fixture and [saving the results of each to an S2P file](#).
4. With the test fixture connected to the VNA and a DUT inserted, the measurement results now appear as though calibration was performed at the connections to the DUT, and the device was measured in a 50-ohm single-ended test environment. The following steps will cause the results to reflect the performance of the device as though the device is embedded in the circuit in which it will be used.
5. Port 1 of the device is a single-ended port and sees a source impedance the same as the VNA system impedance, so no change is required. However, if Rs were a value other than 50 ohms, [Port 1 Impedance Conversion](#) would be used to simulate the different impedance.
6. [Port Matching](#) is used to simulate L1 inductance. Select any of the Shunt L circuits to embed (add) to the measurement results. Enter the value of L and R. The C and G values can be entered as 0 (zero).
7. [Port Matching](#) is used to simulate C1 and C2 capacitance. For both port 2 and port 3, select any of the **Series C** circuits to embed (add) to the measurement results. Enter the value of C and G. The L and R values can be entered as 0 (zero).
8. [Balanced Conversion](#) mathematically simulates the measurement in balanced mode.
9. [Differential Port Matching](#) is used to simulate L2 inductance. Select Shunt L- Shunt C and enter the inductance / resistance value. The C and G values can be entered as 0 (zero).
10. Finally, [Differential Z Conversion](#) is used to simulate a circuit termination of 200 ohms. If you are making Common Mode measurements, specify [Common Mode Z Conversion](#).

Last modified:

29-Sep-2015 First Release



Port Extensions

Port extensions allow you to electrically move the measurement reference plane after you have performed a calibration.

Note: This feature is available to GCA, and standard (S-Parameter) channels.

- [Why and How to use Port Extensions](#)
- [Manual Port Extensions Procedure](#)
- [Port Extensions dialog and Toolbar](#)
- [Step Size dialog](#)
- [Automatic Port Extension dialog](#)

See Also

VNA Data Flow Map

[Fixture Compensation features](#)

[Phase Accuracy](#)

[Comparing the VNA Delay Functions](#)

Other Calibration Topics

Why use Port Extensions

1. You are unable to perform a calibration directly at your device because it is in a test fixture. Perform a calibration at a convenient place, then use port extensions to compensate for the time delay (phase shift), and optionally the loss, caused by the fixture.
2. You have already performed a calibration, and then decide that you need to add a length of transmission line in the measurement configuration. Use port extensions to "tell" the analyzer you have added the length to a specific port.

Important Note: Port Extensions and VNA Data Flow

See VNA Data Flow diagram

Normally, Port Extensions are applied to individual S-parameters in the **Phase Correction** process and only applies to displayed S-parameters.

However, when [Fixturing](#) is ON or when making a [Balanced Measurement](#), Port Extension compensation is applied in the **Apply Error Terms** process which affects ALL S-parameters, whether displayed or not. This allows all underlying S-parameters to have proper extensions applied.

Therefore, when using Port Extensions with features that require more than a single S-parameter (such as k-factor in equation editor), do one of the following:

- Enable [Fixturing](#) - Individual Fixturing features are NOT required to be enabled.
- Use [8510 Mode Data Processing](#).

When Port Extension compensation is applied in the **Apply Error Terms** process, after a [Data-to-Memory](#) operation has been performed, further changes to Port Extensions settings will NOT be applied to the Memory trace.

How to use Port Extensions

- If you know the **electrical length** of the fixture or additional transmission line, enter the value directly to the **Time** setting.
- If you know the **physical length** of the fixture or additional transmission line, enter the value directly to the **Distance** setting.
- If you do **NOT** know either the electrical or physical length of the fixture or additional transmission line, you must be able to connect an OPEN or SHORT to the new reference plane - in place of the DUT. In most cases, removing the DUT will leave a suitable OPEN at the new reference plane.
- Port Extensions can then be added manually (as follows), or by using [Automatic Port Extensions](#).

Manual Port Extensions Procedure

1. Select a calibrated S11 measurement.
2. Select Phase format.
3. With an OPEN or SHORT at the calibration reference plane, verify that the phase across the frequency span is at or near zero.
4. Connect the fixture or added transmission line and attach an OPEN or SHORT in place of the DUT. In most cases, removing the DUT will leave a suitable OPEN at the new reference plane. On the Port Extension toolbar or dialog, increase either **Time** or **Distance** until the phase response is flat across the frequency span of interest.
5. If you know the loss of the additional transmission line, enter the [Loss Compensation](#) values using either one or two data points.

Note: Most OPEN and SHORT standards have delay. Therefore, adjusting delay with this method results in a delay equal to two times the delay of the OPEN or SHORT.

How to access Port Extensions settings

Using **Hardkey/SoftTab/Softkey**

1. Press **Cal** > **Port Extension** > **Port Extensions...**

Programming Commands

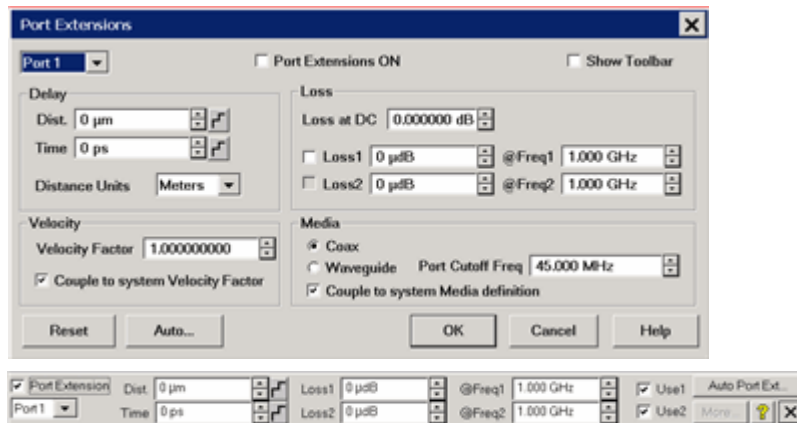

Port Extensions dialog and Toolbar help

Note: This feature is available to the following [measurement classes](#): GCA, Noise Fixture, NFX, and standard (S-Parameter) channels.

Port extensions settings affect all measurements on the active channel that are associated with a particular port.

[Learn Why and How to use Port Extensions](#) (scroll up).

Port Extension Turns ON and OFF port extensions on all ports.

Port Select a VNA port for delay and loss values. Port Extensions settings affect ALL measurements on the active channel that are associated with a particular port.

Show Toolbar Check to show the Port Extensions toolbar. The toolbar allows you to make adjustments to the port extensions while showing more of the VNA screen. Beginning with VNA rev A.08.50, this is the only way to show or hide the toolbar.

Delay settings

Enter delay in either Distance or Time by entering a value or clicking the up/down arrows. Click  to start the [Step Size](#) dialog.

Time The amount of port extension delay in time. Enter a positive value.

Distance The amount of port extension delay in physical length. Enter a positive value.

Distance Units (Dialog ONLY) Select from Meters, Inches, or Feet. The Step Size setting will not change automatically. [Learn more.](#)

Loss Compensation

The following settings allow the entire frequency span to be corrected for loss.

Loss at DC Offsets the entire frequency span by this value. Loss1 or Use1 must also be checked. To compensate for loss at DC, enter a positive value which causes the trace to shift in the positive (up) direction.

Loss @Frequency Check the box, and enter values for Loss and Frequency

When **Loss1** or **Loss1/Loss2** are used, a curved-fit algorithm is used as follows:

Loss1 ONLY:

$$\text{Loss}(f) = \text{Loss1} * (f/\text{Freq1}) ^ 0.5$$

Loss1 and Loss2:

Set the lower frequency to Loss1, and the higher frequency to Loss2.

$$\text{Loss}(f) = \text{Loss1} * (f/\text{Freq1}) ^ n$$

Where:

$$n = \log_{10} [\text{abs}(\text{Loss1}/\text{Loss2})] / \log_{10} (\text{Freq1}/\text{Freq2})$$

Note: abs = absolute value

Velocity

Velocity Factor For each port, sets the velocity factor that applies to the medium of the device that was inserted after the measurement calibration. The value for a polyethylene dielectric cable is 0.66 and 0.7 for PTFE dielectric. 1.0 corresponds to the speed of light in a vacuum.

Couple to system Velocity Factor When unchecked, the Velocity Factor is set for only the specified port and only for Port Extensions. When checked, sets the Velocity Factor for all ports. In addition, changing this value also changes this setting for the [Electrical Delay](#) and Time Domain Distance Marker features.

Media

For each port, select the media of the added transmission line or fixturing.

Coax Select when the fixture or added transmission line is coax. Also specify the velocity factor of the coax.

Waveguide / Cutoff Frequency Select when the fixture or added transmission line is waveguide. Also enter cutoff (minimum) frequency of the waveguide.

Note: when using a Waveguide cal Kit, set [System Z0](#) to 1 ohm before calibrating.

Couple to system Media Definition. When unchecked, the Waveguide Cutoff Frequency is set for only the specified port and only for Port Extensions. When checked, sets the Waveguide Cutoff Frequency for all ports. In addition, changing this value also changes this setting for the [Electrical Delay](#) feature.

Reset All port extensions settings are changed to preset values. The Port Extension ON / OFF state is NOT affected.

Auto Ext. Starts the [Automatic Port Extensions](#) dialog box

Note: Individual receiver port extensions (A,B, and so forth) can no longer be set. (Sept. 2004)



Step Size dialog box help

Changes the step size that occurs when the Time or Dist up/down arrows are pressed on the Port Extension toolbar. The Units for step size are changed on the Port Extension dialog.

Auto Step Size is set to the default value.

User Defined Enter a step size value, then click OK.

This value remains the same when the units are changed. For example if a step size of 12 is entered on this dialog, then you change the units from Inches to Feet, the step size of 12 inches becomes 12 feet, not 1 feet. Therefore, change the units first, then set the step size.

Learn about [Port Extensions](#) (scroll up)

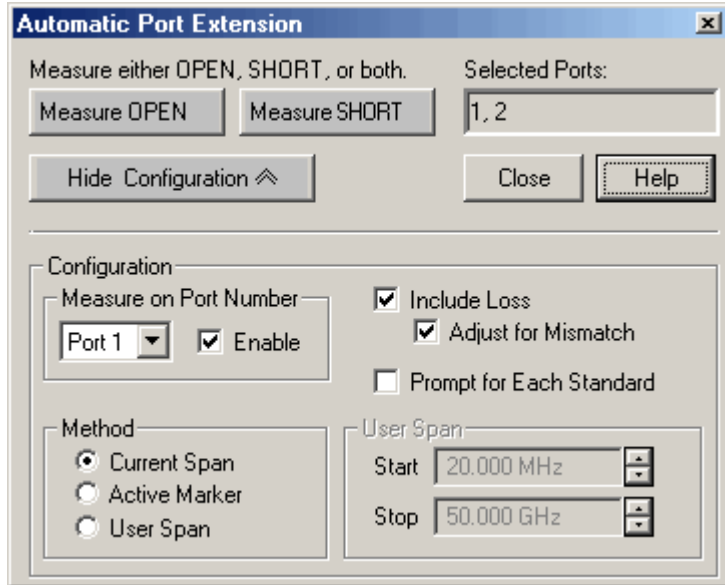

Automatic Port Extension dialog box help

Automatic Port Extension AUTOMATICALLY performs the same operation as [Manual Port Extension](#). By connecting a SHORT or OPEN, the reference plane is automatically moved to the point at which the standard is connected. In addition, Automatic Port Extension will optionally measure and compensate for the loss of the additional transmission line.

Auto Port Extension is NOT available when:

- Sweep type is set to power sweep
- Frequency Offset is ON
- Media is set to Waveguide

Note: Turn OFF [Equations](#) that may exist on the active trace when using Automatic Port Extensions.

Auto Port Extensions Procedure

1. Connect the added transmission line or fixture. Attach an OPEN or SHORT to all affected ports at the new reference plane. In most cases, removing the DUT will leave a suitable OPEN at the new reference plane.
2. On the Port Extension toolbar, click **Auto Port Ext**. Click **Show Configuration** to make additional settings.
3. Click **Measure** to perform the port extension calculations. The resulting delay and loss settings are entered into the port extension toolbar. These settings are saved with Instrument Save or you can manually record the values and enter them again when required.

Settings

Measure either OPEN, SHORT, or both. Press a button to make the measurement of the reflection standard.

Measure either OPEN or SHORT depending on which is most convenient. An ideal OPEN and SHORT, with zero loss and delay, is assumed. Therefore, accuracy is most affected by the quality of the standard. In most cases, removing the DUT will leave a suitable OPEN at the new reference plane. When measuring both OPEN and SHORT standards, the average of the two is used and will slightly improve accuracy.

Selected Ports Indicates the ports that currently have automatic port extension enabled. By default, ALL VNA ports are enabled. To disable a port, see Measure on Port Number below.

Note: Port Extensions settings affect ALL measurements on the active channel that are associated with a particular port.

Show/Hide Configuration Press to either show or hide the following configuration settings in the dialog box.

Measure on Port Number

Select port number to enable or disable automatic port extension.

Enable Check to enable the specified port. All enabled ports will have their reference plane automatically adjusted after performing Automatic Port Extension.

Include Loss Check to automatically measure the loss in the additional transmission line and apply compensation. To calculate loss compensation, frequencies at 1/4 and 3/4 through the frequency range are usually used as Freq1 and Freq2 values. [Learn more about Loss Compensation.](#)

Adjust for Mismatch Only available when **Include Loss** is checked. Mismatch adds ripple to the S11 and S22 traces. If the ripple is large, S11 and S22 can appear greater than 0 dB which leads to numeric instabilities in using the S-parameters. Adjust for mismatch increases the loss of the fixture so that the peak of the ripples is below 0 dB. While this adds more error (all the error is negative) it does allow the S-parameters to be used in simulators without numerical instabilities.

Check - Offsets the trace to cause all of the data points to be at or below zero.

Clear - Most accurate application of the curve-fit calculation, but allows positive responses.

Prompt for Each Standard Check to invoke a prompt when the Measure OPEN or SHORT button is pressed. The prompt will indicate which standard to connect to which port.

Method

Select the span of data points which will be used to determine correction values for phase and loss (optional). If a portion of the current frequency span does not have flat or linear response, you can eliminate this portion from the calculations by using a reduced User Span.

To calculate loss compensation, Current Span and User Span methods usually use frequencies at 1/4 and 3/4 through the frequency range as Freq1 and Freq2 values. See [Loss Compensation](#) to learn more about how loss is calculated.

Current Span Use the entire frequency span to determine phase and loss values.

Active Marker Use only the frequency at the active marker, and one data point higher in frequency, to calculate phase and loss values. If a marker is not present, one will be created in the center of the frequency span.

User Span Use the following User Span settings to determine phase and loss values.

User Span

Start Enter start frequency of the user span.

Stop Enter stop frequency of the user span.

Learn about [Port Extensions](#) (scroll up).

See also [Comparing the VNA Delay Functions](#)

Last modified:

2-Sep-2014 First Release



Swap Adapters Calibration Method

Although Swap Adapters calibration (also known as Swap Equal Adapters and Equal Length Adapters) method is NOT included in the VNA firmware, you can still perform this calibration.

Before we introduced the of the [Unknown Thru](#) method, the Swap Adapters method was often used as a quick alternative to the more tedious [adapter removal](#) method. In that case, you would be trading measurement accuracy for convenience. You might still want to perform Swap Adapters if you do NOT have calibration standards with the same connector type as your DUT. A procedure for this is shown below.

For any other reason, the Swap Adapters method is NOT recommended because the [Unknown Thru](#) method is more convenient AND more accurate.

There are many variations on the Swap Adapters calibration depending on the number of ports to be calibrated and whether the DUT is [insertable or non-insertable](#). However, the concepts are the same: you perform connect and measure the reflection standards (OPEN, SHORT, and LOAD) with one adapter in place, then swap for a different adapter for the Thru measurement. The adapters must have the same delay, loss, and impedance. The better the adapters match, the better measurement results. Measure the adapters with a calibrated VNA to be sure.

Procedure

The following is an example procedure showing how to perform a Swap Adapters 2-port calibration for a non-insertable DUT. The DUT has 2.92 mm connectors. You do NOT have 2.92 mm calibration standards, but you DO have 2.4 mm standards and adapters that have the same electrical properties as the 2.92 mm adapters.

Adapters A1 and A2 = test port to 2.4 mm adapters

Adapters B1 and B2 = test port to 2.92 mm adapters

1. Start the Smart Cal. **Note:** The VNA will NOT prompt you to connect the adapters by name or when to swap the adapters.
2. Specify the connector type and gender and Cal Kit of the adapter that you will be using (2.4 mm) - NOT the connector type of the DUT (2.92 mm). By specifying the connector gender, you are also specifying the Thru method (flush thru for insertable and Unknown Thru for non-insertable.) For example, when both DUT ports have female connectors, we will perform an Unknown Thru cal.
3. When prompted for reflection standards on port 1, connect the Open, Short, and Load standards to Adapter A1.
4. When prompted for reflection standards on port 2, connect the Open, Short, and Load standards to Adapter A2.

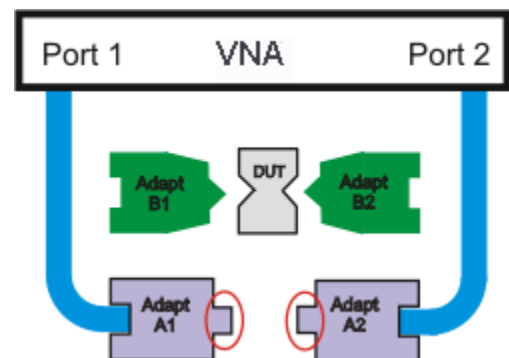

3. Calibrate a Measurement

5. When prompted for a Thru connection, swap Adapter A1 and A2 for B1 and B2. Connect the Thru device. This could be any device that meets the requirements of the [Unknown Thru standard](#). In the case of a non-insertable DUT, connect B1 and B2.

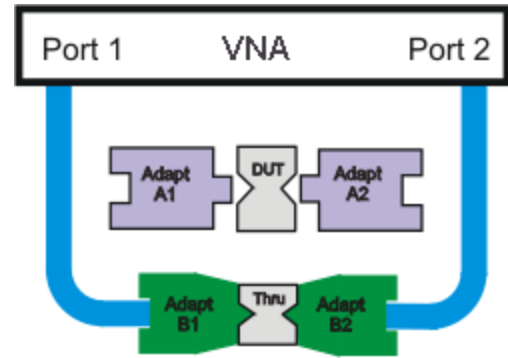

6. Make DUT measurements with Adapters B1 and B2 in place.

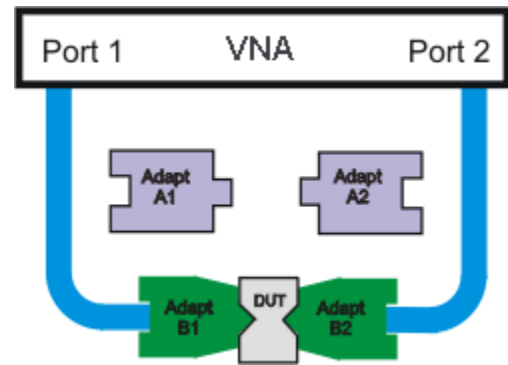

Last Modified:

2-Sep-2014 First Release

Concepts

Calibration Overview

The following is discussed in this topic:

- [What Is Measurement Calibration?](#)
- [Why Is Calibration Necessary?](#)
- [Conditions Where Calibration Is Suggested](#)
- [What Is ECal?](#)



See other Calibration Topics

What Is Measurement Calibration?

Calibration removes one or more of the systematic errors using an equation called an error model. Measurement of high quality standards (for example, a short, open, load, and thru) allows the analyzer to solve for the error terms in the error model. See [Measurement Errors](#).

You can choose from different calibration types, depending on the measurement you are making and the level of accuracy you need for the measurement. See [Select a Calibration Type](#).

The accuracy of the calibrated measurements is dependent on the quality of the standards in the calibration kit and how accurately the standards are modeled (defined) in the calibration kit definition file. The calibration-kit definition file is stored in the analyzer. In order to make accurate measurements, the calibration-kit definition must match the actual calibration kit used. To learn more, see [Accurate Calibrations](#).

Calibration Wizard provides the different calibration methods used in the VNA. See [Calibration Wizard](#).

There are quick checks you can do to ensure your measurement calibration is accurate. To learn more see [Validity of a Measurement Calibration](#)

If you make your own custom-built calibration standards (for example, during in-fixture measurements), then you must characterize the calibration standards and enter the definitions into a user modified calibration-kit file. For more information on modifying calibration kit files, see [Calibration Standards](#).

Note: [Instrument Calibration](#) is ensuring the analyzer hardware is performing as specified. This is not the same as measurement calibration.

Why Is Calibration Necessary?

It is impossible to make perfect hardware that would not need any form of **error correction**. Even making the hardware good enough to eliminate the need for error correction for most devices would be extremely expensive.

The accuracy of network analysis is greatly influenced by factors external to the network analyzer. Components of the measurement setup, such as interconnecting cables and adapters, introduce variations in magnitude and **phase** that can mask the actual response of the device under test.

The best balance is to make the hardware as good as practically possible, balancing performance and cost. Calibration is then a very useful tool to improve measurement accuracy.

Conditions Where Calibration Is Suggested

Generally, you should calibrate for making a measurement under the following circumstances:

- You want the best accuracy possible.
- You are adapting to a different connector type or impedance.
- You are connecting a cable between the test device and an analyzer test port.
- You are measuring across a wide frequency span or an electrically long device.
- You are connecting an attenuator or other such device on the input or output of the test device.

If your test setup meets any of the conditions above, the following system characteristics may be affected:

- Amplitude at device input
- Frequency response accuracy
- Directivity
- Crosstalk (isolation)
- Source match
- Load match

What Is ECal

ECal is a complete solid-state calibration solution. It makes one port (Reflection), full two and three-port calibrations fast and easy. See [Using ECal](#).

- It is less prone to operator error.
- The various standards (located inside the calibration module) never wear out because they are switched with PIN-diode or FET switches.
- The calibration modules are characterized using a TRL-calibrated network analyzer.
- ECal is not as accurate as a good TRL calibration.

For information about ordering ECal modules, see [Analyzer Accessories](#) or contact your [Keysight Support Representative](#)

Last Modified:

21-Aug-2014 First Release

Measurement Errors

You can improve accuracy by knowing how errors occur and how to correct for them. This topic discusses the sources of measurement error and how to monitor error terms.

- [Drift Errors](#)
- [Random Errors](#)
- [Systematic Errors](#)
 - [3-Port Error Terms](#)
 - [4-Port Error Terms](#)
- [Monitoring Error Terms](#)

See other Calibration Topics

Drift Errors

Drift errors are due to the instrument or test-system performance changing after a calibration has been done.

Drift errors are primarily caused by thermal expansion characteristics of interconnecting cables within the test set and conversion stability of the microwave frequency converter and can be removed by re-calibrating.

The time frame over which a calibration remains accurate is dependent on the rate of drift that the test system undergoes in your test environment.

Providing a stable ambient temperature usually minimizes drift. For more information, see [Measurement Stability](#).

Random Errors

Random errors are not predictable and cannot be removed through error correction. However, there are things that can be done to minimize their impact on measurement accuracy. The following explains the three main sources of random errors.

Instrument Noise Errors

Noise is unwanted electrical disturbances generated in the components of the analyzer. These disturbances include:

- Low level noise due to the broadband noise floor of the receiver.
- High level noise or jitter of the trace data due to the noise floor and the phase noise of the LO source inside the test set.

You can reduce noise errors by doing one or more of the following:

- Increase the [source power](#) to the device being measured - ONLY reduces low-level noise.
- [Narrow the IF bandwidth](#).
- Apply several measurement [sweep averages](#).

Switch Repeatability Errors

Mechanical RF switches are used in the analyzer to switch the source attenuator settings.

Sometimes when mechanical RF switches are activated, the contacts close differently from when they were previously activated. When this occurs, it can adversely affect the accuracy of a measurement.

You can reduce the effects of switch repeatability errors by avoiding switching attenuator settings during a critical measurement.

Connector Repeatability Errors

Connector wear causes changes in electrical performance. You can reduce connector repeatability errors by practicing good connector care methods. See [Connector Care](#).

Systematic Errors

Systematic errors are caused by imperfections in the analyzer and test setup.

- They are repeatable (and therefore predictable), and are assumed to be time invariant.
- They can be characterized during the calibration process and mathematically reduced during measurements.
- They are never completely removed. There are always some residual errors due to limitations in the calibration process. The residual (after measurement calibration) systematic errors result from:
 - imperfections in the calibration standards
 - connector interface
 - interconnecting cables
 - instrumentation

Reflection measurements generate the following three systematic errors:

- [Directivity](#)
- [Source Match](#)
- [Frequency Response Reflection Tracking](#)

Transmission measurements generate the following three systematic errors:

- [Isolation](#)
- [Load Match](#)
- [Frequency Response Transmission Tracking](#)

Notes about the following Systematic Error descriptions:

- The figures for the following six systematic errors show the relevant hardware configured for a forward measurement. For reverse measurements, internal switching in the analyzer makes Port 2 the source and Port 1 the receiver. 'A' becomes the transmitted receiver, 'B' becomes the reflected receiver, and 'R2' becomes the reference receiver. These six systematic errors, times two directions, results in 12 systematic errors for a two port device.
- For simplicity, it may be stated that ONE standard is used to determine each systematic error. In reality, ALL standards are used to determine ALL of the systematic errors.
- The following describes an SOLT calibration. This does not apply to TRL, or other types of calibration.

Directivity Error

All network analyzers make reflection measurements using directional couplers or bridges.

With an ideal coupler, only the reflected signal from the DUT appears at the 'A' receiver. In reality, a small amount of incident signal leaks through the forward path of the coupler and into the 'A' receiver. This

leakage path, and any other path that allows energy to arrive at the 'A' receiver without reflecting off the DUT, contributes to directivity error.

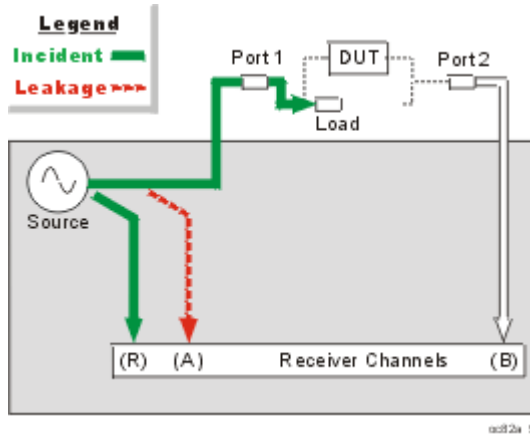

How the Analyzer Measures and Reduces Directivity Error.

1. During calibration, a load standard is connected to Port 1. We assume no reflections from the load.
2. The signal measured at the 'A' receiver results from the incident signal leakage through the coupler and other paths.
3. Directivity error is mathematically removed from subsequent reflection measurements.

Isolation Error

Ideally, only signal transmitted through the DUT is measured at the 'B' receiver.

In reality, a small amount of signal leaks into the 'B' receiver through various paths in the analyzer.

The signal leakage, also known as crosstalk, is isolation error which can be characterized and reduced by the analyzer.

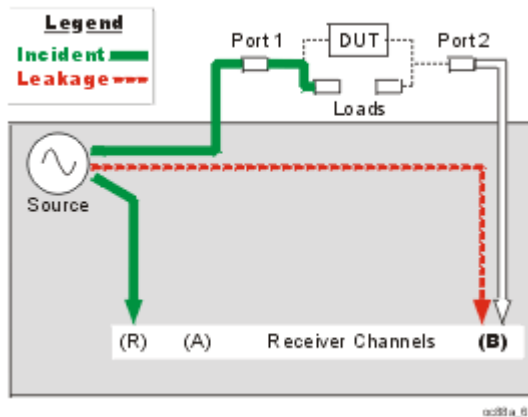

How the Analyzer Measures and Reduces Isolation Error

1. During calibration, load standards are connected to both Port 1 and Port 2.
2. The signal measured at the 'B' receiver is leakage through various paths in the analyzer.
3. This isolation error is mathematically removed from subsequent transmission measurements.

Source Match Error

Ideally in reflection measurements, all of the signal that is reflected off of the DUT is measured at the 'A' receiver.

In reality, some of the signal reflects off the DUT, and multiple internal reflections occur between the analyzer and the DUT. These reflections combine with the incident signal and are measured at the 'A' receiver, but not at the 'R' receiver.

This measurement error is called source match error which can be characterized and reduced by the analyzer.

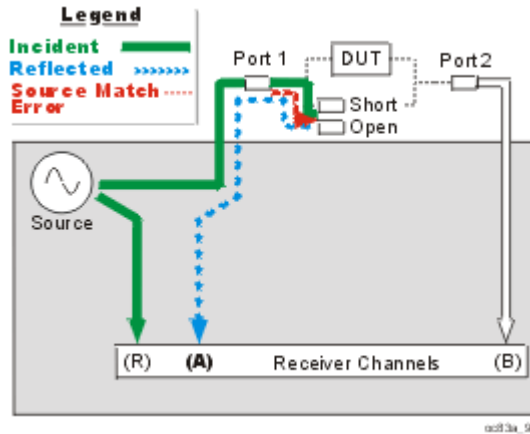

How the Analyzer Measures and Reduces Source Match Error

1. During calibration, all reflection standards are connected to Port 1. Known reflections from the standards are measured at the 'A' receiver.
2. Complex math is used to calculate source match error.
3. Source match error is mathematically removed from subsequent reflection and transmission measurements.

Load Match Error

Ideally in transmission measurements, an incident signal is transmitted through the DUT and is measured at the 'B' receiver.

In reality, some of the signal is reflected off of Port 2 and other components and is not measured at the 'B' receiver.

This measurement error is called load match error which can be characterized and reduced by the analyzer.

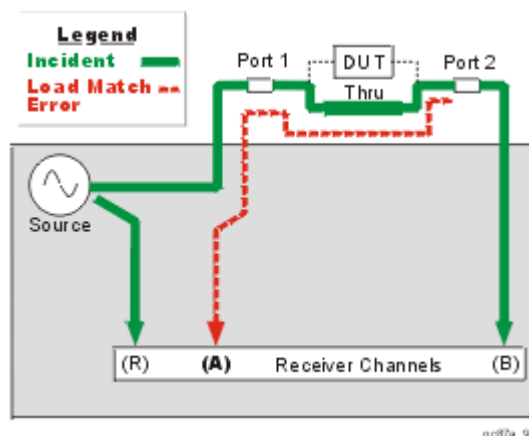

How the Analyzer Measures and Reduces Load Match Error

1. The Port 1 and Port 2 test connectors are mated together for a perfect zero-length thru connection. If this is not possible, a [characterized thru adapter](#) is inserted. This allows a known amount of incident signal at Port 2.

2. The signal measured at the 'A' receiver is reflection signal off of Port 2
3. The resulting load match error is mathematically removed from subsequent transmission and reflection measurements.

Frequency Response Reflection Tracking Error

Reflection measurements are made by comparing signal at the 'A' receiver to signal at the 'R1' receiver. This is called a ratio measurement or "A over R1" (A/R1).

For ideal reflection measurements, the frequency response of the 'A' and 'R1' receivers would be identical.

In reality, they are not, causing a frequency response reflection tracking error. This is the vector sum of all test variations in which magnitude and phase change as a function of frequency. This includes variations contributed by:

- signal-separation devices
- test cables
- adapters
- variations between the reference and test signal paths

Frequency response reflection tracking error can be characterized and reduced by the analyzer.

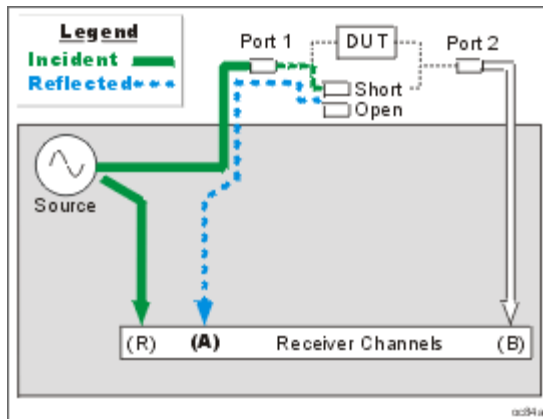

How the Analyzer Measures and Reduces Frequency Response Reflection Tracking Error.

1. During calibration, all reflection standards are used to determine reflection tracking.
2. The average 'A' receiver response is compared with the 'R1' receiver response.
3. Complex math is used to calculate Frequency Response Reflection Tracking Error (see the following diagram). This frequency response reflection tracking error is mathematically removed from subsequent DUT measurements.

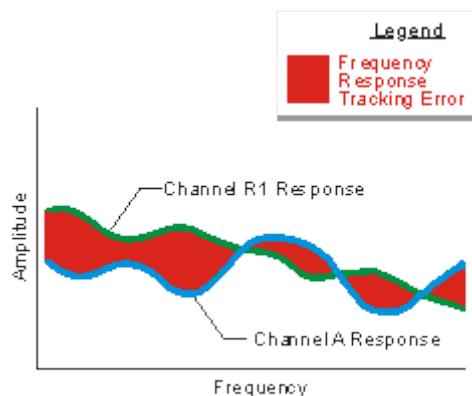

Note: In reflection response calibrations, only a single calibration standard is measured (open or short) and thus only its contribution to the **error_correction** is used.

Frequency Response Transmission Tracking Error

Transmission measurements are made by comparing signal at the 'B' receiver to signal at the 'R1' receiver. This is called a ratio measurement or "B over R1" (B/R1).

For ideal transmission measurements, the frequency response of the 'B' and 'R1' receivers would be identical.

In reality, they are not, causing a frequency response transmission tracking error. This is the vector sum of all test variations in which magnitude and phase change as a function of frequency. This includes variations contributed by:

- signal-separation devices
- test cables
- adapters
- variations between the reference and test signal paths

Frequency response transmission tracking error can be characterized and reduced by the analyzer.

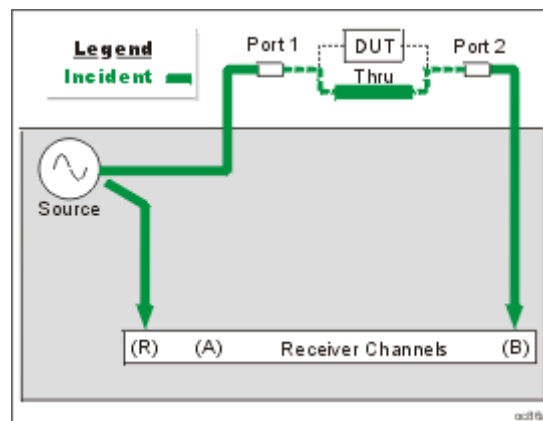

How the Analyzer Measures and Reduces Frequency Response Transmission Tracking Error.

1. During calibration, the Port 1 and Port 2 test connectors are mated together for a perfect zero-length thru connection. If this is not possible, a [characterized thru adapter](#) is inserted. This allows a known amount of incident signal to reach Port 2.
2. Measurements are made at the 'B' and 'R1' receivers.
3. Complex math is used to calculate Frequency Response Transmission Tracking Error (see the following diagram). This frequency response transmission tracking error is mathematically removed from subsequent **DUT** measurements.

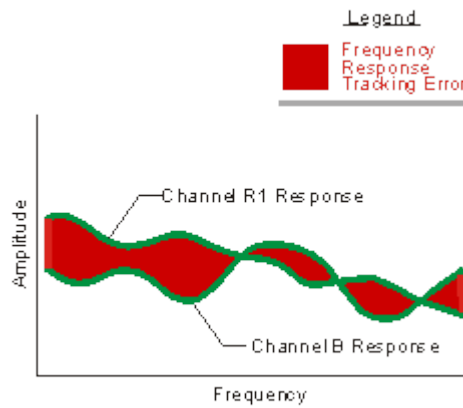

3-Port Error Terms

The following flow diagram displays the 3-port error term model:

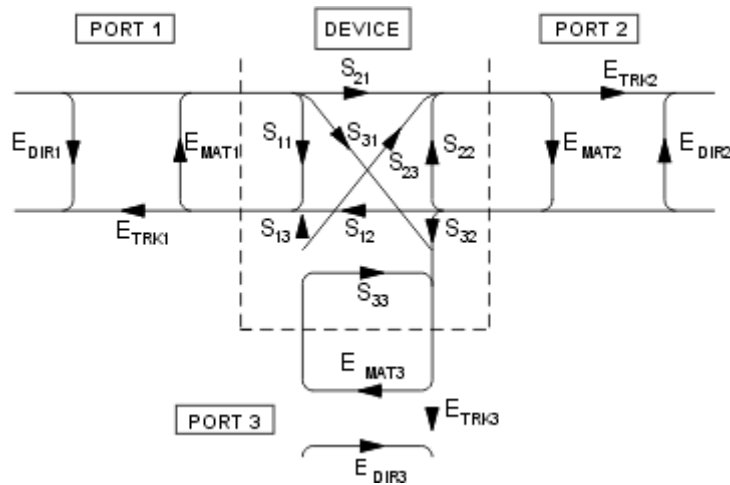

where:

E = error term

DIR = Directivity

MAT = Forward Source Match and Reverse Load Match

TRK = Forward Reflection Tracking and Reverse Transmission Tracking

4-Port error terms

A full 4-port calibration requires the following terms:

[Learn about the port numbering convention](#) for error terms.

		Source Port			
		1	2	3	4
R e	1	DIR 1,1 RTRK	LDM 1,2 TTRK 1,2	LDM 1,3 TTRK 1,3	LDM 1,4 TTRK 1,4

c P o r t		1,1 SRM 1,1	XTLK 1,2	XTLK 1,3	XTLK 1,4
	2	LDM 2,1 TTRK 2,1 XTLK 2,1	DIR 2,2 RTRK 2,2 SRM 2,2	LDM 2,3 TTRK 2,3 XTLK 2,3	LDM 2,4 TTRK 2,4 XTLK 2,4
	3	LDM 3,1 TTRK 3,1 XTLK 3,1	LDM 3,2 TTRK 3,2 XTLK 3,2	DIR 3,3 RTRK 3,3 SRM 3,3	LDM 3,4 TTRK 3,4 XTLK 3,4
	4	LDM 4,1 TTRK 4,1 XTLK 4,1	LDM 4,2 TTRK 4,2 XTLK 4,2	LDM 4,3 TTRK 4,3 XTLK 4,3	DIR 4,4 RTRK 4,4 SRM 4,4

Reflection terms

- DIR: Directivity
- RTRK: Reflection Tracking
- SRM: Source Match

Transmission terms

- LDM: Load Match
- TTRK: Transmission Tracking
- XTLK: Cross Talk

How can we measure only 3 THRU connections?

On a 4-port VNA, a full 4-port cal can be performed while measuring only 3 THRU connections. Measuring more than 3 THRU connections will give higher accuracy.

By measuring all of the reflection terms, and 3 transmission THRU connections, there is adequate information available to calculate the remaining transmission terms. The following is a high level explanation of the concept. The actual calculations are much more complex.

To simplify, let's substitute letters (A,B,C,D) for port numbers from the diagram above so that they can be combined without confusion. Also for simplicity, let's assume that the source match and directivity errors are zero.

	A	B	C	D
A	AA	AB	AC	AD

B	BA	BB	BC	BD
C	CA	CB	CC	CD
D	DA	DB	DC	DD

- The reflection errors are all measured (AA, BB, CC, DD).
- Lets assume we measure a THRU between ports AB, AC, AD. The reverse direction for these THRU's are also measured at the same time (BA, CA, DA).
- The terms left to calculate are BC, CB, BD, DB, CD, DC.

The following shows how the BC term is calculated from BA and AC:

$$\frac{BA * AC}{AA} = \frac{B * \cancel{AA} * C}{\cancel{AA}} = BC$$

Similarly:

- CB is calculated from CA and AB
- BD is calculated from BA and AD
- DB is calculated from AB and DA
- CD is calculated from CA and AD
- DC is calculated from DA and AC

Monitoring Error Terms using Cal Set Viewer

You can use **Cal Set Viewer** to monitor the measured data and the calculated error term. This will help to determine the health of your VNA and the accuracy of your measurements.

By printing or saving the error terms, you can periodically compare current error terms with previously recorded error terms that have been generated by the same VNA, measurement setup, and calibration kit. If previously generated values are not available, refer to Typical Error Term Data in Appendix A, "Error Terms", of the Service Guide.

Note: The service guide for your VNA is available at <http://www.keysight.com/find/pna>

- A stable system should generate repeatable error terms over about six months.
- A sudden shift in error terms over the same frequency range, power, and receiver settings, may indicate the need for troubleshooting system components. For information on troubleshooting error terms, see Appendix A, "Error Terms", of the Service Guide.
- A subtle, long-term shift in error terms often reflects drift or connector and cable wear. The cure is often as simple as cleaning and gauging connectors or inspecting cables.

Viewing Cal Set Data

- Existing measurement traces are unaffected by the Cal Set Viewer.
- The Cal Set data trace is presented in the highest unused channel number (usually 32) in the active window.
- The Cal Set data trace is labeled as S11 in the status bar regardless of the type of error term or standard.
- Only one Cal Set error term or standard data can be viewed at a time. However, a data trace can be stored into memory and then compared to other data traces.

See the error terms equations.

[How to access Cal Set Viewer](#)

Using front-panel HARDKEY [softkey] buttons

1. Press **Cal** > **Cal Sets & Cal Kits** > **Cal Set Viewer ON/OFF**

How to use Cal Set Viewer

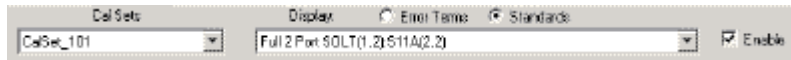

1. Use the down arrow to select a Cal Set. Then click either:
 - **Error Terms** - calculated data.
 - **Standards** - the raw measurement data of the Standard. **ONLY** available with Unguided Cal (not ECal or Guided Cal).
2. Use the down arrow to select an error term or standard to view.
3. Select the **Enable** check box to view the data on the VNA screen.

Port numbering convention for error terms is the same as for S-Parameters:

E Term (Receiver, Source) with the following exceptions:

- Load Match (2,1) - The match of port 2 which is measured by making an S11 measurement.
- Load Match (1,2) - The match of port 1 which is measured by making an S22 measurement.
- Transmission Tracking (2,1) - The port 2 receiver relative to the port 1 reference. (source=port 1).
- Transmission Tracking (1,2) - The port 1 receiver relative to the port 2 reference. (source=port 2).
- And so forth for multiport calibrations.

Last modified:

21-Aug-2014 First Release





Accurate Measurement Calibrations

Calibration accuracy is affected by the type of calibration, quality of the calibration standards, and the care with which the calibration is performed. This section provides additional information about how to make accurate calibrations.

- [Measurement Reference Plane](#)
- [Effects of Using Wrong Calibration Standards](#)
- [Data-based versus Polynomial Calibration Kits](#)
- [Accuracy Level of Interpolated Measurement](#)
- [Effects of Power Level](#)
- [Using Port Extensions](#)
- [Isolation Portion of 2-Port Calibration](#)
- [Choosing a Thru Method](#)

Learn how to [determine the validity of your calibration](#).

See other Calibration Topics

Measurement Reference Plane

Most measurement setups will NOT allow you to connect a device under test (DUT) directly to the VNA front panel test ports. More likely, you would connect your device to test fixtures, adapters, or cables that are connected to the VNA.

A calibration takes place at the points where calibration standards are connected during the calibration process. This is called the measurement reference plane (see graphic). For the highest measurement accuracy, make the calibration reference plane the place where your DUT is connected. When this occurs, the errors associated with the test setup (cables, test fixtures, and adapters used between the analyzer ports and the reference plane) are measured and removed in the calibration process.

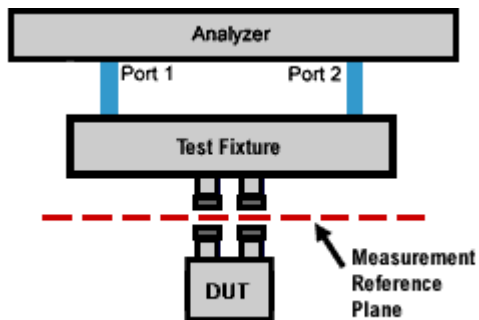

Effects of Using Wrong Calibration Standards

Normally, a calibration is performed using a calibration kit that contains standards with connectors of the same type and sex as your DUT.

However, your calibration kit may not always have the same connector type and gender as your device. For example, suppose your device has 3.5mm connectors, but you have a Type-N calibration kit. If you use an adapter to connect the Type-N standards to the 3.5mm test port, then the adapter becomes part of the calibration and NOT part of the test setup. This will result in significant errors in your reflection measurements.

Data-based versus Polynomial Calibration Kits

The [Select DUT Connectors and Cal Kits](#) dialog box offers a data-based model and a polynomial model for the newest high-frequency cal kits. See VNA Accessories. The data-based models provide higher accuracy for describing calibration standards than the polynomial models. It is RECOMMENDED that the data-based model be used if the most accurate results are desired.

	Data-Based Model	Polynomial Model
How accurate is the model?	Provides highest calibration accuracy. Eliminates the errors that can be the result of polynomial model approximations.	Provides high calibration accuracy.
How does the model define calibration standards?	Uses S-Parameter measurements.	Uses traditional four-term polynomial calibration standard modeling parameters.
How do I manually edit the definitions of the calibration standards when using the model?	Use the Advanced Modify Cal Kit function.	Use the Advanced Modify Cal Kit function.
How do I use the Calibration Wizard with the model?	Use only the SmartCal (Guided) Calibration method.	Use the SmartCal (Guided) or the Unguided Mechanical Calibration methods.

Learn about the [“Expanded Math”](#) feature.

Effects of Power Level

To attain the most accurate error correction, do NOT change the power level after a calibration is performed. However, when changing power within the same attenuator range at which the measurement calibration was performed, S-parameter measurements can be made with only a small degradation of accuracy. If a different attenuator range is selected, the accuracy of error correction is further degraded.

To check the accuracy of a calibration, see [Validity of a Calibration](#).

Using Port Extensions

Use the port extensions feature after calibration to compensate for phase shift of an extended measurement reference plane due to additions such as cables, adapters, or fixtures.

Port extensions is the simplest method to compensate for phase shift, mismatch, and loss of the path between the calibration reference plane and the DUT.

Learn how to apply [port extensions](#).

Learn about [characterizing a test fixture](#).

Isolation Portion of 2-Port Calibration

The isolation portion of a calibration corrects for crosstalk, the signal leakage between test ports when no device is present. When performing an UNGUIDED 2-port calibration, you have the option of omitting the isolation portion of the calibration.

Note: Isolation can be performed on a Smart (Guided) Calibration ONLY

The uncorrected isolation between the test ports of the VNA is exceptional (typically >100dB). Therefore, you should only perform the Isolation portion of a 2-port calibration when you require isolation that is better than 100dB. Perform an isolation calibration when you are testing a device with high insertion loss, such as some filter stopbands or a switch in the open position.

The isolation calibration can add noise to the error model when the measurement is very close to the noise floor of the analyzer. To improve measurement accuracy, set a narrow IF Bandwidth.

[How to perform an isolation calibration](#)

Isolation is measured when the Load standards are connected to the VNA test ports. For best accuracy, connect Load standards to BOTH test ports each time you are prompted to connect a load standard. If two Loads are not available, connect the untested VNA port to any device that will present a good match.

Choosing a Thru Method

When calibrating for a non-insertable device, you must choose a method to calibrate for the THRU error terms. This can have a significant effect on measurement accuracy. Learn more about [choosing a thru method](#).

Last Modified:

29-Sep-2015 First Release.

Calibration Thru Methods

- [What is a Non-Insertable Device](#)
- [Choosing a Thru Method](#)
- [Flush Thru](#)
- [Adapter Removal](#)
- [Swap Adapters](#) (separate topic)
- [Defined Thru](#)
- [Unknown Thru](#)
- [ECal Thru Method Choices](#)

Other Cal Topics

What is a Non-Insertable Device

To understand the Thru method choices, you must first understand what is meant by "Non-Insertable device". These definitions also apply to ECal modules. Substitute "ECal module" for "device". Then see [ECal Thru Method Choices](#).

A **non-insertable device** is one whose connectors could NOT mate together. They either do not have the same type of connector or they have the same gender. This also means that the test port cables would not mate together, as in the following diagram.

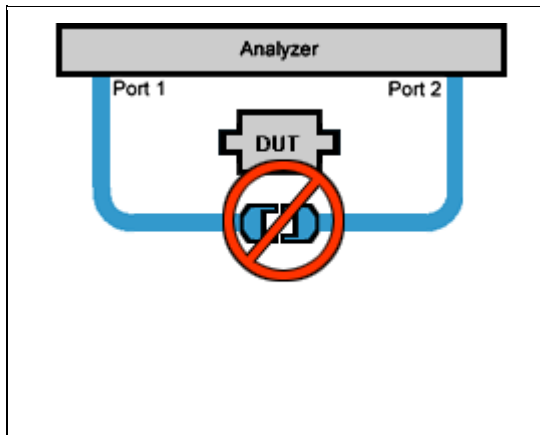

An **insertable** device is one whose connectors could mate together. They have the same type of connector and opposite, or no, gender. This also means that the test port cables would mate together, as in the following diagram.

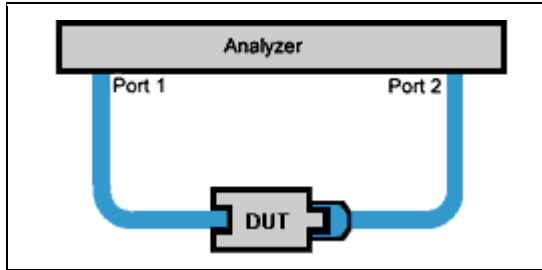

Choosing a Thru Method of Calibration

The Thru method is selected from the Cal Wizard. Select the **Modify** checkbox in the [Select DUT Connectors and Cal Kits](#) dialog box.

Notes:

For ECal, the following choices have different meanings. See [THRU methods for ECal](#).

For 4-port calibration, see [How can we measure only 3 THRU connections?](#)

Choice for Insertable Devices: FLUSH Thru (also known as Zero-length Thru)

When calibrating for an insertable device, the test ports at your measurement reference plane connect directly together. This is called a zero-length THRU, or Flush THRU meaning that the THRU standard has zero-length: no delay, no loss, no capacitance, and no inductance. Your calibration kit may not have a physical THRU standard because it is assumed you have an insertable device and will be using a zero-length THRU.

Choices for Non-Insertable Devices

The following methods calibrate for a non-insertable device:

- [Adapter Removal](#) Accurate, but least convenient.
- [Defined Thru](#)
- [Unknown Thru Cal](#) **Preferred method.**

Adapter Removal Calibration

This method is potentially very accurate. However, it requires many connections which increases the chances of inaccurate data.

Two full 2-port calibrations are performed: one with the adapter connected at port 1, and the other with the adapter connected to port 2. The result of the two calibrations is a single full 2-port calibration that includes accurate characterization and removal of the mismatch caused by the adapter.

Performing an Adapter Removal Cal requires:

- a THRU adapter with connectors that match those on the DUT.
- calibration standards for both DUT connectors.

To select Adapter Removal during a SmartCal, select the **Modify** checkbox in the [Select DUT Connectors and Cal Kits](#) dialog box. The Cal Wizard will guide you through the steps.

Learn how to perform an [Adapter Removal Cal using ECal](#).

Defined Thru (also known as Known Thru, Cal Kit Thru, ECal Thru, Characterized Thru)

Defined Thru uses the THRU definition that is stored in the Cal Kit file or ECal module. The THRU standard may have worn over time, making it not as accurate as when it was new. Defined Thru is usually more accurate than Adapter Removal, but not as accurate as [Unknown Thru](#) method.

Notes

- If performing an ECal, this is the THRU standard in the ECal Module.
- If Defined Thru appears as a potential THRU method in the [SmartCal Wizard](#), this means that there is a defined THRU standard in the selected Cal Kit. This could be a [Zero-length Thru](#). The SmartCal Wizard will prompt you to connect the required standard when appropriate.

To define a THRU standard in a Cal Kit (not ECal module):

1. From the VNA Menu, click Calibration, [Advanced Modify Cal Kits](#).
2. Select the Cal Kit
3. Click Edit Kit
4. Click Add
5. Select THRU
6. Complete the dialog box.

The next time you perform a Guided Cal, this Defined THRU standard will be available if the DUT connector types match the THRU standard.

Unknown Thru Cal

Unknown Thru Cal is the **preferred** THRU method of calibrating the VNA to measure a non-insertable device.

The Unknown Thru calibration is also known as **Short-Open-Load-Reciprocal Thru (SOLR)** calibration.

- Very easy to perform.
- Better accuracy than [Defined Thru](#) and usually better than [Adapter Removal](#).
- Does not rely on existing standard definitions that may no longer be accurate.
- Causes minimal cable movement if the THRU standard has the same footprint as the DUT. In fact, the DUT can often BE the THRU standard.
- NOT recommended when there is 40 dB or more of combined loss in the Unknown Thru and calibration path. This would NOT allow enough signal to accurately measure at the receiver.

About the Unknown Thru Process

SmartCal guides you through the process. Although the following process describes ports 1 and 2, Unknown Thru can be performed on any two ports when using a multiport VNA.

1. Perform 1-port cal on port 1.
2. Perform 1-port cal on port 2.
3. Connect Unknown Thru between ports 1 and 2.
4. Measure Unknown Thru.
5. [Confirm Estimated Delay](#). This estimate may be wrong if there are too few frequency points over the given frequency span. You can measure the delay value independently and enter that value in the dialog box.

The Unknown Thru Standard

- Can have up to 40 dB of combined loss in the Unknown Thru and calibration path.
- Must be reciprocal: $S_{21}=S_{12}$.
- Must know the phase response to within 1/4 wavelength (see step 5 above).
- Can be the DUT if it meets these conditions.

Unknown Thru Limitations

- Unknown Thru is NOT supported during a TRL calibration.

- Beginning with VNA code release 5.25, Unknown Thru CAN be performed using a 4-port PNA-L that does NOT have a reference receiver for each test port. However, a Delta Match Calibration is usually required before the Unknown Thru is measured.
- Unknown Thru is NOT supported on E8801A, E8802A, and E8803A.

ECal Thru Method Choices

When the ECal module connectors exactly match the DUT connectors, choose from the following THRU methods:

ECal Thru as Unknown Thru [Learn more about Unknown Thru.](#)

- Measures the THRU state of the ECal module as an Unknown Thru.
- The default method when the ECal module connectors match the DUT.
- Very accurate and easy.
- May require a Delta Match Cal.

Flush Thru (zero-length Thru) [Learn more about Flush Thru](#)

- Requires an insertable ECal module / DUT.
- Remove the ECal module and connect the two reference planes directly together for a zero-length thru.
- Accurate, but not as easy as 'ECal Thru as Unknown Thru'.

ECal (Defined Thru)

- Measures the THRU state of the ECal module.
- Very easy, but not as accurate as 'ECal Thru as Unknown Thru'

Unknown Thru

- Remove the ECal module.
- Then connect a Thru adapter to be measured as Unknown Thru.
- May require a Delta Match Cal.

When the ECal module connectors do NOT exactly match the DUT connectors, choose from the following two methods:

Adapter Removal

- Can be used with ECal when your DUT is [NON-insertable](#). However, the ECal module MUST be insertable, and the adapter connectors must exactly match the connectors of the DUT as in the following diagram.

ECal User Characterization

In cases when adapter removal cannot be performed, ECal [User Characterization](#) is ALWAYS possible if you have the right adapters. A User Characterization is performed once and stored in the ECal module. However, accuracy is compromised every time you remove, then reconnect, the adapter with the ECal module.

Last Modified:

21-Aug-2014 First Release



Validity of a Calibration

This section helps you determine if your calibration is valid and how the analyzer displays correction level information for your measurement.

- [Frequency Response of Calibration Standards](#)
- [Validating a Calibration](#)
- [Quick Check](#)
- [ECal Confidence Check](#)
- [Verification Kit](#)

See other Calibration Topics

Frequency Response of Calibration Standards

In order for the response of a calibration standard to show as a dot on the [smith chart display format](#), it must have no phase delay with respect to frequency. The only standards that exhibit such "perfect" response are the following:

- 7-mm short (with no offset)
- Type-N male short (with no offset)

There are two reasons why other types of calibration standards show phase delay after calibration:

1. The reference plane of the standard is electrically offset from the mating plane of the test port. Such devices exhibit the properties of a small length of transmission line, including a certain amount of phase shift.
2. The standard is an open termination, which by definition exhibits a certain amount of fringe capacitance and therefore phase shift. Open terminations which are offset from the mating plane will exhibit a phase shift due to the offset in addition to the phase shift caused by the fringe capacitance.

The most important point to remember is that all standards are measured in order to remove [systematic errors](#) from subsequent device measurements. As a result, if calibration standards with delay and fringe capacitance are measured as a device after a calibration, they will NOT appear to be "perfect". This is an indication that your analyzer **is calibrated accurately and working properly**.

Validating a Calibration

At the completion of a calibration or selection of a stored Cal Set, validation can accomplish the following:

Improve Measurement Accuracy – Once a measurement calibration has been performed, its performance should be checked before making device measurements. There are several sources of error that can invalidate a calibration: bad cables, dirty or worn calibration standards that no longer behave like the modeled standards, and operator error.

Verify Accuracy of Interpolation – You should validate the calibration if you are testing a device and the measurements are uncertain because of interpolation. For more information see [Interpolation Accuracy](#).

Verify Accuracy of Cal Standards – To check accuracy, a device with a known magnitude and phase response should be measured.

Quick Check

For this test, all you need are a few calibration standards. The device used should not be one of the calibration standards; a measurement of one of these standards is merely a measure of repeatability.

The following reflection and transmission Quick Check tests can be applied to all test ports.

To verify reflection measurements, perform the following steps:

1. Connect either an OPEN or SHORT standard to port 1. The magnitude of S11 should be close to 0 dB (within a few tenths of a dB).
2. Connect a load calibration standard to port 1. The magnitude of S11 should be less than the specified calibrated directivity of the analyzer (typically less than -30 dB).

To verify transmission measurements:

1. Connect a THRU cable (or known device representative of your measurement) from port 1 to port 2. Verify the loss characteristics are equivalent to the known performance of the cable or device.
2. To verify S21 isolation, connect two loads: one on port 1 and one on port 2. Measure the magnitude of S21 and verify that it is less than the specified isolation (typically less than -80 dB).

Note: To get a more accurate range of expected values for these measurements, consult the analyzer's specifications.

ECal Confidence Check

ECal Confidence Check is a method to check the accuracy of a calibration performed with mechanical standards or an ECal module. The confidence check allows you to measure an impedance state in the ECal module (called the confidence state), and compare it with factory measured data stored in the module.

In order for this test to be valid, the test ports of the ECal module must connect directly to the calibration reference plane (without adapters).

How to Perform ECal Confidence Check:

1. Connect ECal module to the analyzer with the USB cable. See [Connect ECal Module to the VNA](#). **Note:** Terminate any unused ECAL ports with a 50 ohm load.
2. Allow the module to warm up for 15 minutes or until the module indicates **READY**.
3. Do one of the following to start ECal Confidence Check

Using front-panel HARDKEY [softkey] buttons

1. Press **Cal** > **Cal Sets & Cal Kits** > **ECal Confidence Check**

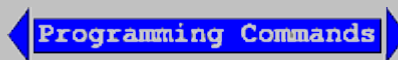

On the following [ECal Confidence Check dialog box](#):

2. Click **Read Module Data**. The following occurs:
 - ECal module is set to "confidence state".
 - VNA reads and displays stored data.
 - VNA measures and displays "confidence state".
3. To view a different parameter, select **Change Measurement** and select the check box for the desired parameter. The default is the active channel parameter.
4. Select the viewing option in the Trace View Options block.

5. Compare the stored and measured data for each measurement parameter.

Notes:

- After exiting ECal Confidence Check, the ECal module remains in the same impedance state and the factory (or user-characterized) data is still stored in the memory trace. Therefore, you can save both the data and memory trace as a *.csv files and import them to a spreadsheet. [Learn how.](#)
- If the two traces show excessive difference, there may be a loose or dirty connection at the test ports or damage to the test cables. Carefully inspect the cables and connections. Then clean and gage each connector, and re-calibrate if needed.
- The User Characterization setting selects the user-characterization data instead of the factory characterization data (available when a User-Characterization is stored in the ECal module).

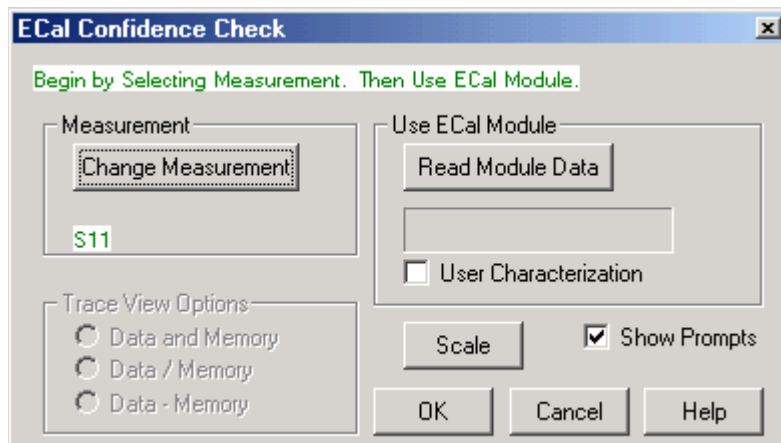

ECal Confidence Check dialog box help

Compares the accuracy of corrected (calibrated) data with stored data in the ECal module. For the check to be valid, the module test ports must connect directly to the calibration reference plane (without an adapter). [Learn more about ECal Confidence Check.](#)

Measurement

Change Measurement Opens the Measure dialog box.

Use ECal Module

Read Module Data

- Copies stored data from the ECal module to Memory.
- Changes state of ECal module to confidence state.
- Measures and displays confidence state and Memory trace.

Scale Opens the Scale dialog box.

Show Prompts Check to show a reminder for the connection (default).

Trace View Options

Data and Memory Trace Displays current measurement data and Memory trace.

Data / Memory Performs an operation where the current measurement data is divided by the data in memory.

Data + Memory Performs an operation where the current measurement data is added to the data in memory.

Verification Kit

E5080A

Measuring known devices, other than calibration standards, is a straightforward way of verifying that the network analyzer system is operating properly. Verification kits use accurately known verification standards with well-defined magnitude and phase response. These kits include precision airlines, mismatch airlines, and precision fixed attenuators. Traceable measurement data is shipped with each kit on disk and verification kits may be re-certified by Keysight.

See [Analyzer Accessories](#) for a list of Keysight verification kits.

Last modified:

21-Aug-2014 First Release



Calibration Standards

This following section explains the general principles and terms regarding calibration kit files. To learn **how** to modify calibration kit files, See [Modify Calibration Kits](#).

- [About Calibration Kits](#)
- [Calibration Standards](#)
- [Standard Type](#)
- [Standard Definitions](#)
- [Class Assignments](#)

See other Calibration Topics

About Calibration Kits

A calibration kit is a set of physical devices called standards. Each standard has a precisely known or predictable magnitude and phase response as a function of frequency.

In order to calibrate the analyzer using the standards in a calibration kit, the response of each standard must be mathematically defined and then organized into standard classes that correspond to the error models used by the analyzer.

To be able to use a particular calibration kit, the known characteristics from each standard in the kit must be stored into analyzer memory. This is done for you with the VNA. All Keysight Cal Kits containing standard definitions are stored in the VNA. For a list of Keysight calibration kits, see [Analyzer Accessories](#).

Calibration Standards

Calibration standards provide the reference for error-corrected measurements in the network analyzer. Each standard has a precisely known definition that includes electrical delay, impedance, and loss. The analyzer stores these definitions and uses them to calculate error correction terms.

During measurement calibration, the analyzer measures standards and mathematically compares the results with "ideal models" of those standards. The differences are separated into error terms that are later removed from device measurements during error correction. [See Systematic Errors](#).

Standard Type

A standard type is one of four basic types that define the form or structure of the model to be used with that standard. The following are the four basic standard types:

Standard	Terminal Impedance
SHORT	zero ohms
OPEN	infinite ohms
LOAD	system impedance, Z0
THRU/LINE	no terminal impedance

[Learn about other Calibration Standards:](#)

- [Data-Based Standard](#)

- [Sliding Load](#)
- [Offset Load](#)
- [Arbitrary Impedance Load](#)

Standard Definitions

Standard definitions describe the electrical characteristics of the standards and the frequencies they will be used. Standard definitions can be viewed from the [Advanced Modify Cal Kit](#) menu selection. Standard definitions include:

- **Minimum Frequency** Specifies the minimum frequency the standard is used for calibration.
- **Maximum Frequency** Specifies the maximum frequency the standard is used for calibration.
- **Z0** Specifies the characteristic impedance of the standard (not the system characteristic impedance or the terminal impedance of the standard).
- **Delay** Specifies a uniform length of transmission line between the standard being defined and the actual calibration plane.
- **Type** Specifies type of standard (SHORT, OPEN, THRU/LINE, LOAD, ARBITRARY).
- **Loss** Specifies energy loss, due to skin effect, along a one-way length of coaxial cable.

Loss model equation:

- The value of loss is entered as ohms/second at 1 GHz.
- To compute the loss of the standard, measure the delay in seconds and the loss in dB at 1 GHz. Then use the following formula:

$$\text{Loss} \left(\frac{\Omega}{\text{s}} \right) = \frac{\text{loss (dB)} \times Z_0(\Omega)}{4.3429(\text{dB}) \times \text{delay(s)}}$$

Capacitance model equation:

C0, C1, C2, C3. Specifies the fringing capacitance for the open standard.

- $C = (C0) + (C1 \times F) + (C2 \times F^2) + (C3 \times F^3)$
- (F is the measurement frequency).
- The terms in the equation are defined when specifying the open as follows:
 - C0 term is the constant term of the third-order polynomial and is expressed in Farads.
 - C1 term is expressed in F/Hz (Farads/Hz).
 - C2 term is expressed in F/Hz².
 - C3 term is expressed in F/Hz³.

Inductance model equation:

L0, L1, L2, L3. Specifies the residual inductance for the short standard.

- $L = (L0) + (L1 \times F) + (L2 \times F^2) + (L3 \times F^3)$
- (F is the measurement frequency).
- The terms in the equation are defined when specifying the short as follows:
 - L0 term is the constant term of the third-order polynomial and is expressed in Henries.
 - L1 term is expressed in H/Hz (Henries/Hz)

- L2 term is expressed in H/Hz^2 .
- L3 term is expressed in H/Hz^3 .

Class Assignments

Once a standard is characterized, it must be assigned to a standard "class". A standard class is a group of standards that are organized according to the calibration of the VNA error model.

The number of classes needed for a particular calibration type is equal to the number of error terms being corrected.

A class often consists of a single standard, but may be composed of multiple standards. These may be required for accuracy or to cover a wide frequency range.

Example: A response calibration requires only one class, and the standards for that class may include an OPEN, or SHORT, or THRU. A 1-port calibration requires three classes. A 2-port calibration requires 10 classes, not including two for isolation.

The number of standards assigned to a given class may vary from one to seven for unguided calibrations. Guided calibrations allow as many standards as needed.

Calibration Classes are assigned in the Advanced Modify Cal Kit menu, [SOLT](#) or [TRL](#) tab.

The different classes used in the VNA:

S11A, S11B, S11C (S22A, S22B, S22C and so forth)

These are the three classes for port 1-reflection calibrations (three classes also for S22 and S33). They are used in the one-port calibrations and the full two-port calibration. They are required in removing the directivity, source match, and reflection tracking errors. Typically, these classes might consist of an open, a short and a load standard for each port.

Transmission and Match (forward and reverse)

These classes are used to perform a full two-port calibration. The transmission class relates primarily to the transmission tracking, while the match class refers to load match. For both of these classes, the typical standard is a thru or delay.

Isolation

The isolation classes are used to perform a full two-port and the TRL two-port calibrations. The isolation classes apply to the forward and reverse crosstalk terms in the VNA error model.

TRL THRU

These are used to perform a TRL two-port calibration. The TRL thru class should contain a thru standard or a short line. If it contains a non-zero length thru standard, then the calibration type is called LRL or LRM.

TRL REFLECT

This class is used to perform a TRL two-port calibration. The TRL reflect class should contain a standard with a high reflection coefficient, typically an open or short. The actual reflection coefficient need not be known, but its phase angle should be specified approximately correctly (± 90 deg). The exact same reflection standard must be used on both ports in the TRL calibration process.

TRL LINE or MATCH

These are used to perform a TRL two-port calibration. The TRL line or match class should contain line standards, load standards, or both. If a line standard is used, its phase shift must differ from that of the TRL THRU standard by 20° to 160°. This limits the useable frequency range to about 8 to 1. Two or more line standards of different lengths may be specified to get broader frequency coverage. It is also common to include a load standard for covering low frequencies, where the line's length would be impractically long. When a load is used, the calibration type is called TRM or LRM.

Note: For more information, read [Specifying Calibration Standards and Kits for Keysight Vector Network Analyzers \(Application Note 1287-11\)](#)



Modify Cal Kits

Modify Calibration Kits

VNA CalKit Editor, a standalone application, has been integrated into the VNA Firmware.

The following topics discuss Modifying Calibration Kits:

Using VNA CalKit Editor

- [Connectors Tab](#)
- [Standards Tab](#)
- [SOLT Tab](#)
- [TRL Tab](#)

Concepts

- [Why Modify a Cal Kit](#)
- [VNA Cal Kit File Types](#)
- [About VNA Cal Kits and Firmware Upgrades](#)

Procedures

- [How to Create a New Cal Kit from an Existing Cal Kit](#)
- [Creating Custom Calibration Kits using a New Connector Family](#)

Note: Although the User Interface is changed, the existing remote commands can still be used to modify Cal Kits.

How to Modify Cal Kits

The series of dialog boxes that follow allow you to modify the standard definitions or class assignments of calibration kit files.

Using **Hardkey/SoftTab/Softkey**

1. Press **Cal** > **Cal Sets & Cal Kits** > **Cal Kit...**

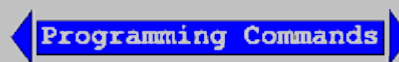

Edit VNA Cal Kits

Manage Cal Kits dialog box help

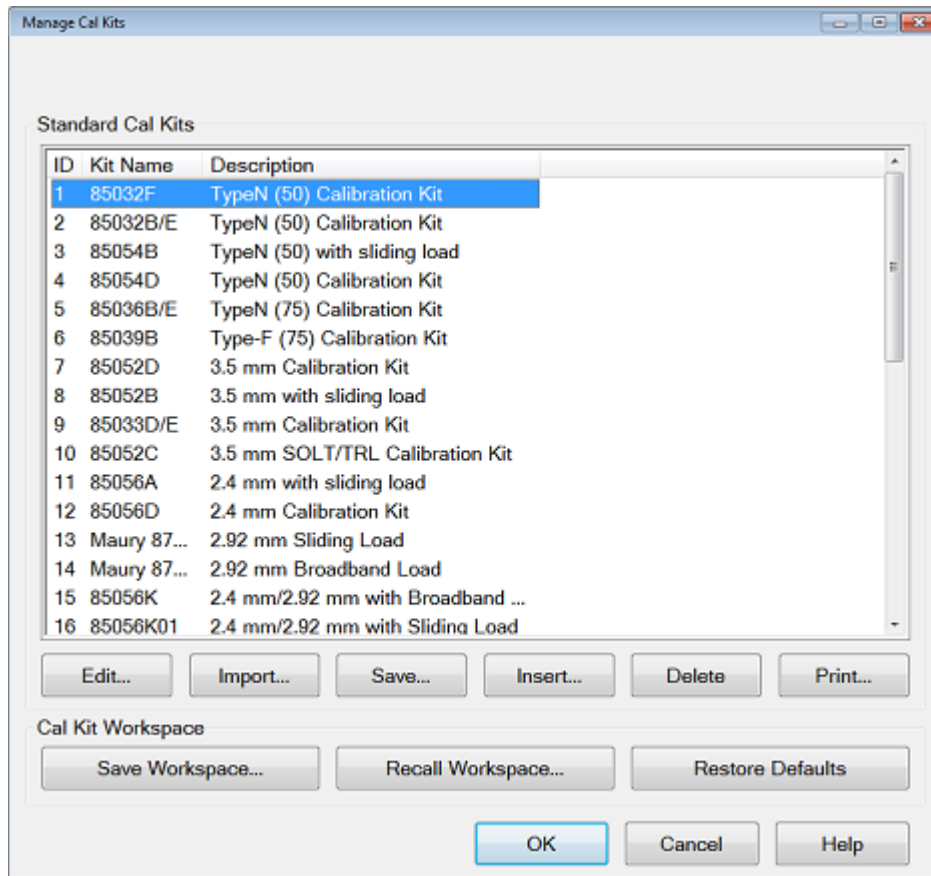

Provides access to all Keysight cal kits and allows modification of their standard definitions.

VNA Cal Kits and Firmware Upgrades

- All VNA cal kits can only be imported by the current firmware revision and later. They can NOT be imported by PAST firmware revisions. Once a Cal Kit has been imported by a later firmware revision, it cannot be imported by the previous version of firmware from which it originated.

Edit... Invokes the [Connectors tab](#) of the Edit Kit dialog box to modify selected calibration kit definitions.

Import... Invokes the [Import Kit](#) dialog box.

Save... Saves the selected calibration kit definitions using **.xkt**, **.ckt** or **.prn** file type). See [VNA Cal Kit File Types](#) topic.

Insert... Invokes a blank [Edit Kit dialog box](#) to create new calibration kit definitions.

Delete Deletes selected calibration kit file.

Print... Prints the contents of the selected cal kit to a **.prn** file.

Save Workspace... Saves ALL cal kits in the VNA to a ***.xkw** or ***.wks** file. The ***.wks** format was the default format used by older revisions of PNA firmware for archiving a group of cal kit definition - it is NOT an Excel spreadsheet file.

Recall Workspace... Opens an archive of cal kits from past firmware upgrades and 'Save As' operations.

Restore Defaults Re-installs the default factory contents of all Keysight cal kits from the VNA hard drive. The factory Keysight cal kits are stored on the VNA hard drive at D:\PnaCalKits\factory.

Installed Kits

For more information see [Creating Custom Calibration Kits using a New Connector Family](#).

Import Kit dialog box help

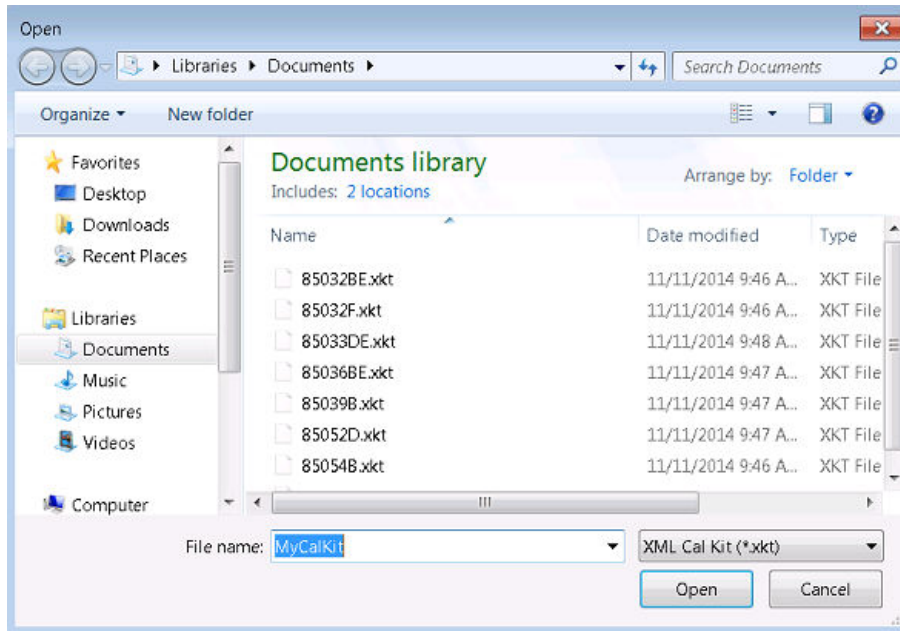

Note: There is no limit to the number of cal kits that can be imported. However, during an [Unguided cal](#), you can access ONLY mechanical cal kits #1 through 95.

Imports calibration kit definitions from hard disk or other drive that are saved in the various formats.

Files of type Select the file type of your Cal Kit. Learn more about [VNA Cal Kit File Types](#)

File name Navigate and select your cal kit file.

Open Imports the selected file. The kit is added at the end of the list of cal kits.

Note: [See VNA Cal Kits and Firmware Upgrades](#)

Importing Kits other than current VNA Series Kits

Cal kit files from Keysight "legacy" network analyzers (listed above) may not contain information that the VNA requires. Therefore, the VNA may modify the cal kit name and description, the cal standards, and the cal class assignments in a best effort manner. You may need to correct these modifications after importing your legacy cal kit to meet your specific requirements.

- "Legacy" cal kit files are based on the analyzer test port gender while VNA cal kits are based on the Device Under Test (DUT) connector gender. Therefore, when the kit is imported, the standard label and description are reversed and are noted as F- (female) and M- (male) .
- When a Coaxial standard is detected in the kit file, a pair of male/female connectors is typically created.
- Waveguide standards that are created as connector have no gender.

Last modified:

E5080A

8-Dec-2014 Initial Release



Why Modify a Cal Kit

For most applications, the default calibration kit models provide sufficient accuracy for your calibration. However, several situations may exist that would require you to create a custom calibration kit:

- Using a connector interface different from those used in the predefined calibration kit models.
 - Using standards (or combinations of standards) that are different from the predefined calibration kits. For example, using three offset SHORTs instead of an OPEN, SHORT, and LOAD to perform a 1-port calibration.
 - Improving the accuracy of the models for predefined kits. When the model describes the actual performance of the standard, the calibration is more accurate. For example: A 7 mm LOAD is determined to be 50.4 Ω instead of 50.0 Ω .
 - Modifying the THRU definition when performing a calibration for a non-insertable device.
 - Performing a TRL calibration.
-

Last modified:

21-Aug-2014 First Release

About VNA Cal Kits and Firmware Upgrades

The default "factory" cal kits are overwritten when new firmware is installed. Your custom cal kits (files with custom filenames) are NOT overwritten. However, the custom cal kits must be imported (click **Import Kit**) into the new firmware.

All VNA cal kits can only be imported by the current firmware revision and later. They can NOT be imported by PAST firmware revisions. Once a Cal Kit has been imported by a later firmware revision, it cannot be imported by the previous version of firmware from which it originated.

When a firmware upgrade takes place, ALL cal kits, both factory and custom, that are present on the VNA are saved to a single *.wks file using a unique filename. These files are NOT Excel spreadsheet files. They are opened using the **Open** button . They can be used as archives of cal kits from previous firmware versions.

Last modified:

21-Aug-2014 First Release

Creating a New Connector Family

To create a custom calibration kit that uses a new connector type, you must first define the connector family. The connector family is the name of the connector-type of the calibration kit, such as:

- APC7
- 2.4 mm
- Type-N (50Ω)

Although more than one connector family is allowed, it is best to limit each calibration kit to only one connector family.

If you are using a connector family that has male and female connectors, include definitions of both genders. If you are using a family with no gender, such as APC7, only one connector definition is required.

Use the following steps to create a custom calibration kit:

1. Press **Cal** > **Cal Sets & Cal Kits** > **Cal Kit...**
2. At the **Manage Cal Kit** dialog box, click **Edit Kit...**
3. In the **Connectors Tab**, click **Add** to name the new connector family.
4. Enter the Kit Description for the custom cal kit.
5. Click **Add** in the Connectors section of the dialog box.
6. Enter a Connector Family name.
7. Enter a Description of the connector.
8. Select the Gender of one of the connectors.
9. Enter the minimum and maximum Frequency Range.
10. Enter the Impedance.
11. Click the down-arrow to select the Media.
12. Enter the cut-off frequency
13. Click **Apply**.
14. Click **OK**.
15. If you need to add another connector gender, in the **Connectors Tab**, click **Add** in the Connectors section again for the next connector gender.
16. If you are adding another connector gender, repeat step 3.

Note: If you have male and female versions of the connector family, you probably do NOT also have a NO GENDER version.

Enter Standards

Now that the connector family is added to the custom cal kit, you are ready to add new calibration standards.

1. In the **Standards Tab**, under the list of standards, click **Add**.
2. Select the type of standard (OPEN, SHORT, LOAD, or THRU), then click **OK**.
3. Complete the information in the dialog box for the standard you selected. Note that for banded standards, the start and stop frequency may be different than the frequency range of the specified connector. Edit the start and stop frequencies as needed. Click **OK** when all the settings are correct.

E5080A

4. Repeat steps 2 - 3, as necessary, to add all standards and definitions to the new custom cal kit.
 5. Assign each of the standards to a calibration class. This is done through the [TRL Tab](#) or [SOLT Tab](#)
 6. Save the Cal Kit.
-

Last modified:

21-Aug-2014 First Release

How to Create a New Cal Kit from an Existing Cal Kit

You can create a new custom Cal Kit using an existing Cal Kit as a starting point.

Here is how:

1. Press **Cal** > **Cal Sets & Cal Kits** > **Cal Kit...**
2. At the **Manage Cal Kit** dialog box, click **Save As** and change the file name. Select either ***.xkt**, ***.ckt** or ***.prn** file type. [Learn more about these file types.](#)
3. Make modifications to your new custom Cal Kit as required.
4. Routinely save your work by clicking **Save**.

See Also

[About VNA Cal Kits and Firmware Upgrades](#)

Last modified:

22-Aug-2014 First Release

VNA Cal Kit File Types

The VNA Cal Kit editor can open the following types of Cal Kit files:

VNA Families	File Type
Current VNA Series Cal Kits	*.xkt (default with VNA, PNA A.10.00 and above) *.ckt *.ckx
Old VNA Series Cal Kit (before PNA A.07.50)	*.ck1
8510 Cal Kit	.CK_*
8753, 8752, 8719, 8720, or 8722 Cal Kit	*.ck
Current FieldFox Cal Kits	*.xkt
Previous FieldFox Cal Kits	*.xml

The current revision of Cal Kit files can be downloaded at <http://na.support.keysight.com/pna/caldefs/stddefs.html>

File Save (As)

The VNA Cal Kit Editor can save Cal Kits in three formats:

- ***.xkt** - An XML-based format, supported by multiple VNA families (the default format).
- ***.ckt** - VNA binary format - can be read by VNA and PNA Rev. A.07.50 and higher. This format is provided for backwards compatibility with older PNA firmware revisions and may not support future new Cal Kit capabilities like the *.xkt format is expected to.
- ***.prn** - Cal Kit print files. This is a text file format which can be read into spreadsheets, but the Cal Kit Editor does not read-in these files, it only produces them as a form of documentation.

File Association

With the exception of *.xml, the above file types are automatically associated with the CalKit Editor if they are not already associated with a different program. That means, after running CalKit Editor, double-clicking any of the above file types (except *.xml) will open the file using CalKit Editor.

If you have already associated one of these file types with a different program and would like to change it to CalKit Editor, do the following:

1. Right-click the file, then click **Open With**
2. Browse to the CalKitEditor install folder.
 - C:\Program Files (x86)\Agilent\VNA Cal Kit Editor
3. Check **Always use the selected program to open this kind of file.**
4. Select **CalKit Editor.**

Last modified:

25-Aug-2014 First Release

Connectors Tab

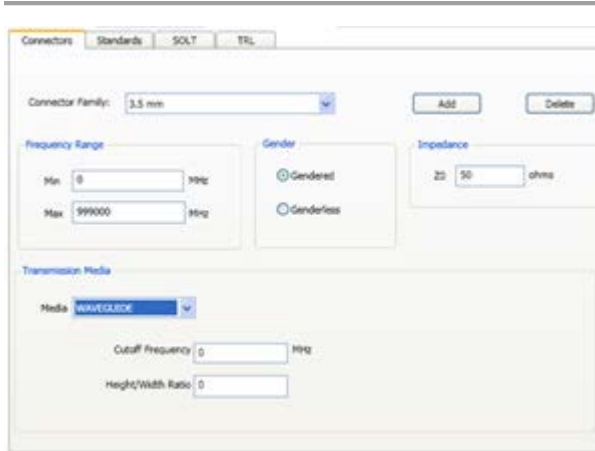

Cal Kit Name Allows you to change the Name of the selected calibration kit.

Cal Kit Description Allows you to change the description of the selected calibration kit.

Connector Family .Click the down arrow to select the connector family associated with the Cal Kit.

Add Starts the [Add Connector](#) dialog box which allows you to add new connector type to the calibration kit.

Delete Deletes - **WITHOUT WARNING** - the selected connector family.

Note: To modify a connector family or name, Add a new connector, then delete the old connector.

The following is the list of Factory-defined connector type strings:

	Type N (50) female	7-16 female	X-band waveguide
	Type N (50) male	7-16 male	P-band waveguide
APC 3.5 female	Type N (75) female	2.92 mm female	K-band waveguide
APC 3.5 male	Type N (75) male	2.92 mm male	Q-band waveguide
APC 2.4 female	Type F (75) female	1.85 mm female	R-band waveguide
APC 2.4 male	Type F (75) male	1.85 mm male	U-band waveguide
APC 7	Type A (50) female	1.0 mm female	V-band waveguide
	Type A (50) male	1.0 mm male	W-band waveguide
	Type B		

Frequency Range

Min Allows you to define the lowest frequency at which the standard is used for calibration.

Max Allows you to define the highest frequency at which the standard is used for calibration.

Gender

Gendered - The connector family contains both Male and Female connectors.

Genderless - The connector family does NOT contain Male and Female connectors. APC7 connectors are an example of this connector type.

Impedance

Specify the impedance of the standard.

Media

The medium (or 'geometry') of the connector (COAX or WAVEGUIDE).

Cutoff Frequency If Media is Waveguide, type the low-end cutoff frequency.

Height/Width Ratio Used to calculate waveguide loss. This value is usually on the data sheet for waveguide devices.

About Waveguide Cal Kits

If modifying or creating a waveguide cal kit, be sure to make the following settings. You can [create a custom waveguide cal kit](#) using an existing factory waveguide Cal kit as a starting point. The factory cal kits already have these settings.

- Frequency Range: **Min. frequency = Cutoff frequency.**
- Gender: **No Gender**
- Impedance Z0: **1 ohm**
- Media: **Waveguide**

For waveguide, choose TRL (Thru-Reflect-Line) calibration type . These calibration types are more accurate and take fewer steps than SOLT.

Add Connector Family



Enter a name for the new connector family. Then click **OK**.

Available at the bottom of every tab

Save As - Allows you to save the cal kit to a new file name and type.

Save - Saves the cal kit to the same file name and type.

Close - Closes the cal kit editing session. The file is NOT saved automatically.

Last modified:

25-Aug-2014 First Release

Standards Tab

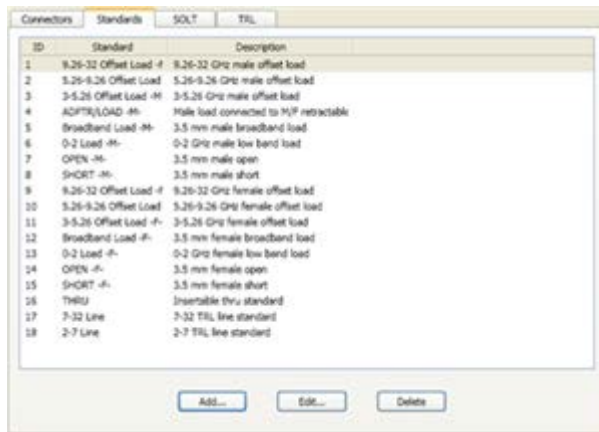

Allows you to Add, Edit or Delete cal standards in a cal kit.

Add Standard (Open, Short, Load, Thru, or Data-based)

Add Standard dialog box help



Allows you to add standards to the calibration kit file.

Choose from:

- [OPEN](#)
- [SHORT](#)
- [LOAD](#)
- [THRU](#)
- [DATA-BASED](#)
- [ISOLATION](#)

Standards dialog box help

The following fields apply to **ALL** standard types:

Standard ID	19	Label	OPEN -M- 2
Description	3.5 mm male open 2		

The other areas of the dialog change depending on the type of standard selected.

Identification

Standard ID Number in list of standards

Label Type of standard. This usually appears in prompts for standards.

Description Description of standard.

The following fields apply to ALL standard types EXCEPT the Isolation type:

The screenshot shows a dialog box with two sections. The first section, titled 'Connector', has a label 'Port 1' followed by a dropdown menu currently showing '3.5 mm male'. The second section, titled 'Frequency Range', has two input fields: 'Min' with the value '0' and 'Max' with the value '999000', both followed by the unit 'MHz'.

Connector

Indicates the type and gender (Male, Female, None) of the standard.

Thru and Isolation standards have two connectors.

Data-Based standards MAY have two connectors.

Frequency Range

Min Defines the lowest frequency at which the standard is used for calibration.

Max Defines the highest frequency at which the standard is used for calibration.

The Delay Characteristics fields apply to MOST standard types:

The screenshot shows a dialog box with three input fields. The first is 'Delay' with the value '0' and the unit 'pSec'. The second is 'Loss' with the value '0' and the unit 'Gohms/s'. The third is 'Z0' with the value '50' and the unit 'ohms'.

Delay Characteristics

Delay Defines the one-way travel time from the calibration plane to the standard in seconds.

Z0 Defines the impedance of the standard.

Loss Defines energy loss in Gohms, due to skin effect, along a one-way length of coaxial cable.

Other fields are unique to standard type

Choose from:

- [OPEN](#)
- [SHORT](#)
- [LOAD](#)

- [THRU](#)
- [DATA-BASED](#)
- [ISOLATION](#)

Open Standard

C0, C1, C2, C3 Specifies the fringing capacitance.

Open Characteristics					
C0	<input type="text" value="0"/>	F(e-15)	C2	<input type="text" value="0"/>	F(e-36)/Hz ²
C1	<input type="text" value="0"/>	F(e-27)/Hz	C3	<input type="text" value="0"/>	F(e-45)/Hz ³

These are the unique fields of the dialog. [See the areas that are common to all standards.](#)

Short Standard

L0, L1, L2, L3 Specifies the residual inductance.

Short Characteristics					
L0	<input type="text" value="0"/>	H(e-12)	L2	<input type="text" value="0"/>	H(e-33)/Hz ²
L1	<input type="text" value="0"/>	H(e-24)/Hz	L3	<input type="text" value="0"/>	H(e-42)/Hz ³

Load Standard

Choose from the following

Load Type
<input checked="" type="radio"/> Fixed Load
<input type="radio"/> Sliding Load
<input type="radio"/> Offset Load
<input type="radio"/> Arbitrary Impedance

Fixed Load Specifies the load type as Fixed. The fixed load is assumed to be a perfect termination without reflection.

Sliding Load

A sliding load is defined by making multiple measurements of the device with the sliding load element positioned at various marked positions of a long transmission line. The transmission line is assumed to have zero reflections and the load element has a finite reflection that can be mathematically removed using a least squares circle fitting method.

A sliding load cal can be very accurate when performed perfectly. It can also be very inaccurate when not using proper technique. **For accurate results, closely follow the users manual instructions for the sliding load.**

Arbitrary Impedance

Specifies the load type that has an impedance value different from system Z0. An arbitrary impedance device is similar to a fixed load except that the load impedance is NOT perfect. Early firmware releases of the VNA series used a fixed resistance value. A complex terminating impedance has been added to allow for more accurate modeling of circuit board or on-wafer devices.

The following Complex Impedance settings are available ONLY when Arbitrary Impedance is selected.

- **Real** The real portion of the impedance value.
- **Imaginary** The imaginary portion of the impedance value.

Offset Load

Using an Offset Load standard results in a more accurate calibration than with a Broadband Load. Therefore, when performing a calibration using one of the modified Cal Kit definitions, you may be prompted to connect more standards than before this change. To revert to using the Broadband Load Standard without offset, do the following:

1. Press **Cal** > **Cal Sets & Cal Kits** > **Cal Kit...**
2. At the **Manage Cal Kit** dialog box, click **Edit Kit...**
3. Select the **SOLT** tab.
4. Under the Calibration Kit Classes, select **SC** (Loads)
5. Under the SC Selected Standards, select **Broadband Load**, then click **Move Up** until the standard is at the top of the list. This will ensure that the Broadband Load is used first.

About Offset Load

An offset load is a compound standard consisting of a load element and two known offset elements (transmission lines) of different length. The shorter offset element can be a zero-length (Flush-thru) offset. The load element is defined as a 1-port reflection standard. An offset load standard is used when the response of the offset elements are more precisely known than the response of the load element. This is the case with waveguide. Measurement of an offset load standard consists of two measurements, one with each of the two offset elements terminated by the load element. The frequency range of the offset load standard should be set so that there will be at least a 20 degree separation between the expected response of each measurement.

To specify more than two offset elements, define multiple offset load standards. In cases where more than two offsets are used, the frequency range may be extended as the internal algorithm at each frequency will search through all of the possible combinations of offsets to find the pair with the widest expected separation to use in determining the actual response of the load element.

The following Offset Load settings are available ONLY when Offset Load is selected.

- First Offset Standard
- Second Offset Standard
- Load Standard

Thru Standard

Connectors

Port 1: 3.5 mm female

Port 2: 3.5 mm male

Frequency Range

Min: 0 MHz Max: 38800 MHz

Delay Characteristics

Delay: 0 pSec Loss: 0 Gohms/s

Z0: 50 ohms

Virtual Device

Connectors - Defines connector type at both ends of the Thru standard.

Virtual Device

Most cal kits have only one Thru standard definition for SOLT calibrations. For these cases, use the default selections (checked for zero-length Thrus and cleared for non-zero-length Thrus).

This checkbox is used to make forward and reverse measurements of your Thru standard for the same pair of ports in two separate steps. This is NOT common for zero-length (Flush) Thru standards.

When **checked**, calibration prompts involving that Thru will **omit** the Description. For example “Connect port 1 to port 2”. This is the common prompt for Flush-Thru standards.

When **cleared**, calibration prompts for that Thru will **include** the Description. For example “Connect <standard description> between ports 1 and 2”.

To make forward and reverse measurements of your Thru standard for the same pair of ports as two separate steps, do the following:

1. Create separate definitions of the Thru standard(s) using the same settings, except for the Label and Description. **Clear** this checkbox for BOTH definitions.
2. For one Thru definition, in the label and description include the word 'FORWARD' to prompt the operator to use this standard for the forward measurement. Assign this standard to the SOLT “FWD TRANS” and “FWD MATCH” classes of the cal kit.
3. For the Thru definition, in the label and description include the word 'REVERSE' to prompt the operator to use this standard for the reverse measurement. Assign this standard to the SOLT “REV TRANS” and “REV MATCH” classes of the cal kit.
4. When you perform SOLT calibrations using this cal kit, the forward measurements of the Thru will be measured in one connection step, and the reverse measurements in another.

Data-Based Standard

Response Data Summary

Number of Response Data Variables = 4
 index = 0: Number of Data Variable Values = 900
 Data Variable Name = S11
 index = 1: Number of Data Variable Values = 900
 Data Variable Name = S21

Load Data File...

Accuracy Data Summary

Standard contains no accuracy data

Load Data File...

Virtual Device

Learn about the relative accuracy of [Databased versus Polynomial Cal Kits](#).

The modified file can then be uploaded into the VNA.

Upload Data From File

Click **Load Data File**, then navigate to the *.dat file which is provided with the data-based Cal Kit. Both Response data and Accuracy (Uncertainty) data is provided in a single *.dat file.

For Advanced Users

Response data can be loaded from a *.s2p or *.cti file.

Accuracy data can be loaded from a *.cti file.

Virtual Device

This checkbox is displayed for a Data-Based cal standard when the standard has been defined to have 2 ports.

- When Cleared (default) calibration prompts for that standard will include it's Description. For example "Connect <standard description> between ports 1 and 2".
- When Checked, calibration prompts for that standard will NOT include its Description, so the prompt will be worded as if the data-based standard is a zero-length Thru connection. For example "Connect port 1 to port 2".

Isolation Standard

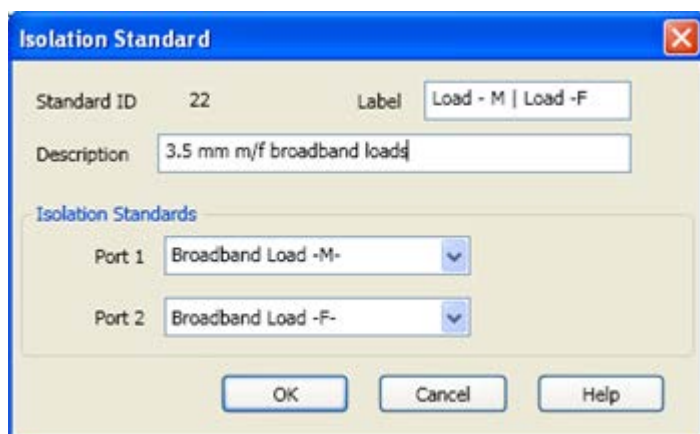

The pair of loads are considered one standard.

Both loads are connected to the VNA and measured with the same prompt.

Available at the bottom of every tab

Save As - Allows you to save the cal kit to a new file name and type.

Save - Saves the cal kit to the same file name and type.

Close - Closes the cal kit editing session. The file is NOT saved automatically.

Last modified:

25-Aug-2014 First Release

SOLT Tab

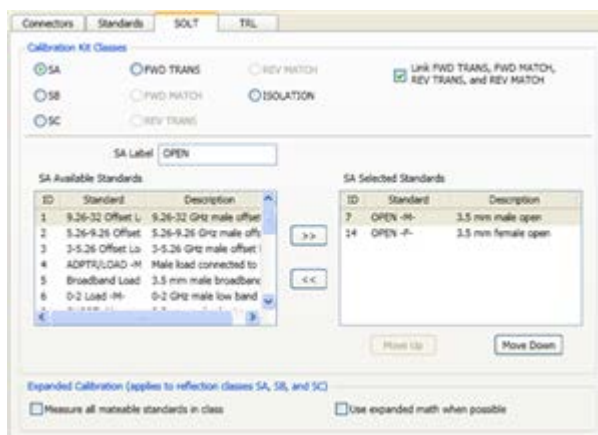

Note: This dialog looks similar to the dialog that appears after the [Cal Wizard View / Modify dialog](#). However, setting changes in that dialog affect ONLY the calibration that is in progress. These settings, accessed through Modify Cal Kit, changes the cal kit for all future calibrations that use this cal kit.

Allows you to assign single or multiple standards to **SOLT** Calibration Classes.

Click the [TRL tab](#) to assign standards to TRL Calibration Classes.

1. For each Cal Kit Class, select **Available Standards** from the left list, then click **>>** to copy the standard to the Cal Kit.
2. Use **Move Up** and **Move Down** to change the order of the standards. The order is used in guided calibrations to determine which standards in that class will be used in calibrations that involve the frequency ranges over which the standards are defined. Guided calcs will include standards in the order in which they appear in this class list, and in the case where standards in the class list have frequency ranges that overlap, the order also determines which standard is used for frequencies in the overlap range. For example, let's assume that you define a broadband Short from Min Freq.= 0 Hz and Max Freq.= 999 GHz, and that standard is listed first in the SB or TRL REFLECT class. If you then list a frequency-banded Short with the same connector below the broadband short in those same classes, then guided calibrations would not use the frequency-banded Shorts because the broadband Shorts would always be given priority.

SOLT <cal class> Label

The cal standard category label that appears in the VNA's user interface during **unguided** SOLT calibrations.

Calibration Kit Classes

For each calibration class, select **Available Standards**, then click **>>** to move to the **Selected Standards** list.

- **SA** - OPEN Standards
- **SB** - SHORT Standards
- **SC** - LOAD Standards
- **FWD / REV Trans and Match** - THRU Standards. Most Cal Kits do NOT include a physical THRU standard, but assume that an Insertable Thru will be used.
- **ISOLATION** - Isolation standard. For VNA analyzers, ISOLATION calibration is not usually recommended. It could be beneficial in some situations where custom user-supplied test set hardware is being used.

Link FWD TRANS, FWD MATCH, REV TRANS, and REV MATCH Check to automatically assign the standard definition for FWD TRANS to FWD MATCH, REV MATCH, and REV TRANS. Clear to separately assign FWD MATCH, REV MATCH and REV TRANS classes (SOLT calibrations only).

Expanded Calibration

The following two check boxes **apply ONLY during Guided Calibrations**. For Unguided Calibration, these check boxes are ignored, including the case where the multiple standards dialog box is presented.

Measure all mateable standards in class Check this box to attain the highest accuracy possible. For example, if a cal kit contains several load standards, during the calibration process you will be prompted to measure each of the standards. This could require a significant amount of calibration time. When checked, the "Use expanded math when possible" box is also checked automatically.

Use expanded math when possible Some kits contain multiple calibration standards of the same type that together cover a very wide frequency range. (For example: multiple shorts, or a lowband load and a sliding load.) If a calibration requires more than one standard to cover the calibration frequency range, there can be regions of overlapping measurements. When this checkbox is selected, the VNA automatically computes the most accurate measurement in the overlap regions using a "weighted least squares fit" algorithm. This function improves accuracy without slowing the calibration speed.

- Manually select this checkbox only when using a cal kit that contains multiple standards of the same type. (For example: multiple shorts, or a lowband load and a sliding load.)
- The checkbox is cleared by default when a polynomial model is selected from the cal kit menu.
- The checkbox is selected by default when the 85058B or 85058E data-based model is selected from the cal kit menu.

Available at the bottom of every tab

Save As - Allows you to save the cal kit to a new file name and type.

Save - Saves the cal kit to the same file name and type.

Close - Closes the cal kit editing session. The file is NOT saved automatically.

Last modified:

25-Aug-2014 First Release

TRL Tab

On the image below, click a setting area to learn more.

Allows you to assign single or multiple standards to Calibration Classes.

1. For each Cal Kit Class, select **Available Standards** from the left list, then click **>>** to copy the standard to the Cal Kit.
2. Use **Move Up** and **Move Down** to change the order of the standards. The order is used in guided calibrations to determine which standards in that class will be used in calibrations that involve the frequency ranges over which the standards are defined. Guided calcs will include standards in the order in which they appear in this class list, and in the case where standards in the class list have frequency ranges that overlap, the order also determines which standard is used for frequencies in the overlap range. For example, let's assume that you define a broadband Short from Min Freq.= 0 Hz and Max Freq.= 999 GHz, and that standard is listed first in the SB or TRL REFLECT class. If you then list a frequency-banded Short with the same connector below the broadband short in those same classes, then guided calibrations would not use the frequency-banded Shorts because the broadband Shorts would always be given priority.

Note: The TRL LINE/MATCH class has a slight exception to these prioritization behaviors. In general, Line standards are given a higher priority than Match standards. So if a Line standard and a Match standard are defined to have the same frequency range and the Match standard is listed above the Line standard in the class order, a guided TRL cal will still prefer to use the Line standard rather than the Match standard.

TRL <cal class> Label

The cal standard category label that appears in the VNA's user interface during **unguided** TRL calibrations.

Cal Kit Classes

- For VNA analyzers, ISOLATION calibration is not usually recommended. It could be beneficial in some situations where custom user-supplied test set hardware is being used.

TRL THRU

Note: All **THRU calibration methods** are supported in a TRL Cal **EXCEPT** Unknown Thru.

- The THRU standard can be either a zero-length or non-zero length. However, a zero-length THRU is more accurate because it has zero loss and no reflections, by definition.
- The THRU standard cannot be the same electrical length as the LINE standard.
- If the insertion phase and electrical length are well-defined, the THRU standard may be used to set the reference plane.
- The THRU standard and LINE standard have the same characteristic impedance and are perfectly matched. They define the reference impedance of the calibration.
- If a THRU standard with the correct connectors is NOT available, an adapter removal cal can be performed.

TRL REFLECT

- The REFLECT standard can be anything with a high reflection, as long as it is the same when connected to one or more VNA ports.
- The REFLECT standard on each port is identical.
- The actual magnitude of the reflection need not be known.
- The phase of the reflection standard must be known within 1/4 wavelength.

- If the magnitude and phase of the reflection standard are well-defined, the standard may be used to set the reference plane.

TRL LINE

The LINE and THRU standards establish the reference impedance for the measurement after the calibration is completed. TRL calibration is limited by the following restrictions of the LINE standard:

- Must be of the same impedance and propagation constant as the THRU standard.
- The electrical length need only be specified within 1/4 wavelength.
- Cannot be the same length as the THRU standard.
- A TRL cal with broad frequency coverage requires multiple LINE standards. For example, a span from 2 GHz to 26 GHz requires two line standards.
- Must be an appropriate electrical length for the frequency range: at each frequency, the phase difference between the THRU and the LINE should be greater than 20 degrees and less than 160 degrees. This means in practice that a single LINE standard is only usable over an 8:1 frequency range (Frequency Span / Start Frequency). Therefore, for broad frequency coverage, multiple lines are required.
- At low frequencies, the LINE standard can become too long for practical use. The optimal length of the LINE standard is 1/4 wavelength at the geometric mean of the frequency span (square root of $f_1 \times f_2$).

Note: The TRL LINE standard must have a delay that is greater than 0 (zero) ps. Otherwise, calibration correction calculations will contain unpredictable results.

TRL MATCH

If the LINE standard of appropriate length or loss cannot be fabricated, a MATCH standard may be used instead of the LINE.

- The MATCH standard is a low-reflection termination connected to both Port 1 and Port 2.
- The MATCH standard may be defined as an infinite length transmission line OR as a 1-port low reflect termination, such as a load.
- When defined as an infinite length transmission line, both test ports must be terminated by a MATCH standard at the same time. When defined as a 1-port load standard, the loads are measured separately. The loads are assumed to have the same characteristics.
- The impedance of the MATCH standard becomes the reference impedance for the measurement. For best results, use the same load on both ports. The load may be defined using the data-based definition, the arbitrary impedance definition, or the fixed load definition.

Calibration Reference Z0 (TRL only)

System Z0 The system impedance is used as the reference impedance. Choose when the desired test port impedance differs from the impedance of the LINE standard. Also, choose when skin effect impedance correction is desired for coax lines.

Line Z0 The impedance of the line standard is used as the reference impedance, or center of the Smith Chart. Any reflection from the line standard is assumed to be part of the directivity error.

Testport Reference Plane (TRL only)

Thru Standard The THRU standard definition is used to establish the measurement reference plane. Select if the THRU standard is zero-length or very short.

Reflect Standard The REFLECT standard definition is used to establish the position of the measurement reference plane. Select if the THRU standard is not appropriate AND the delay of the REFLECT standard is well defined.

Also, select If a flush short is used for the REFLECT standard because a flush short provides a more accurate phase reference than a Thru standard.

LRL line auto characterization

Note: This setting ONLY applies if an LRL Cal Kit is being modified **AND** Testport Reference Plane is set to Thru Standard **AND** the TRL Thru class standard and the TRL Line/Match class standard both have the same values for Offset Z0 and Loss. Otherwise, this setting is ignored.

- Check the box to allow the VNA to automatically correct for line loss and dispersion characteristics.
- Clear the box if anomalies appear during a calibrated measurement which may indicate different loss and impedance values for the Line standards.

Available at the bottom of every tab

Save As - Allows you to save the cal kit to a new file name and type.

Save - Saves the cal kit to the same file name and type.

Close - Closes the cal kit editing session. The file is NOT saved automatically.

Last modified:

25-Aug-2014 First Release

4. Analyze Data

Markers

Markers provide a numerical readout of measured data, a search capability for specific values and can change stimulus settings. There are 15 regular markers and one [Reference marker](#) (used with Delta markers) available per trace. This topic discusses all aspects of markers.

Note: Marker Readout can be turned ON/OFF and customized from the **Customize Display** dialog box. [Learn more.](#)

- [Creating and Moving Markers](#)
- [Marker Setup](#)
 - [Coupling Method](#)
- [Searching with Markers](#)
 - [Maximum and Minimum Search](#)
 - [Peak Search](#)
 - [Multi Peak Search](#)
 - [Target Search](#)
 - [Multi Target Search](#)
 - [Bandwidth and Notch Search](#)
 - [Compression Search](#)
 - [PSAT Search](#)
 - [PNOP Search](#)
- [Search Domain](#)
- [Search Range Indicators](#)
- [Marker Functions](#) (Change Instrument Settings)
- [Marker Display](#)
- [Marker Table](#)

Other Analyze Data topics

Creating and Moving Markers

Creating Markers

How to Create Markers

Using **Hardkey/SoftTab/Softkey**

1. Press **Marker** > **Marker 1-7** / **Marker 8-15** / **Reference**.
2. Click left side **Marker N** or **Reference** small button.

Using a mouse

1. Move the cursor on a trace.
2. Right-click on the trace then select **Add Marker....**

Programming Commands

Moving a Marker

To move a marker, make the marker active by selecting its number in any of the previous 3 methods. The **active marker** appears on the analyzer display as ▽. All of the other markers are inactive and are represented on the analyzer display as Δ. Then change the stimulus value using any of the following methods:

- Type a value.
- Scroll to a stimulus value using the up/down arrows. The resolution can not be changed.
- Click the stimulus box, then use the front-panel knob.
- Click and drag Markers using a finger (touchscreen) or by left-click and holding a marker symbol. Then, drag the marker to any point on the trace. This feature is NOT allowed in Smith Chart or Polar [display formats](#) or with a [Fixed Marker type](#).

Marker Setup

How to set the Marker Setup.

Using **Hardkey/SoftTab/Softkey**

1. Press **Marker > Marker Setup**.
2. Set the value or select desired setting for each softkey.

Using a mouse

1. Move the cursor on a marker.
2. Right-click on the marker then select **Marker....**

Programming Commands

Marker Dialog Box / **Marker > Marker Setup** Softtab Help

Marker - Specifies the current (active) marker number that you are defining.

On - Check to display the marker and corresponding data on the screen.

Stimulus - Specifies the X-axis value of the active marker. To change stimulus value, type a value, use the up and down arrows, click in the text box and use the front-panel knob or drag the marker on the screen.

Delta Marker - Check to make the active marker display data that is relative to the reference (R) marker. There is only one reference marker per trace. All 15 other markers can be regular markers or delta markers. When a delta marker is created, if not already displayed, the reference marker is displayed automatically. A delta marker can be activated from the [Marker dialog box](#) or the [Marker](#)

[Toolbar.](#)

Discrete - Check to display values at only the discrete points where data is measured. Clear to display values that are interpolated from the data points. The interpolated marker will report y-axis data from ANY frequency value between the start and stop frequency.

Checked Fixed - Check to cause the marker to have a fixed X-axis and **Y-axis** position based on its placement on the trace when it was set to fixed. It does NOT move with trace data amplitude. It can be scrolled left and right on the X-axis by changing the marker stimulus value. Use this marker type to quickly monitor "before and after" changes to your test device. For example, you could use fixed markers to record the difference of test results before and after tuning a filter.

Cleared Fixed - Clear the box to create a **Normal** marker, which has a fixed stimulus position (X-axis) and responds to changes in data amplitude (Y-axis). It can be scrolled left and right on the X-axis by changing the marker stimulus value. Use this marker type with one of the marker search types to locate the desired data.

(Marker) Format - Displays the marker data in a format that you choose. The Trace Default setting has the same marker and grid formats. Choose from the following:

Log / Phase	Log Magnitude	Real
Lin / Phase	Linear Magnitude	Imaginary
Re / Im	Phase	
R+jX (Complex impedance)	SWR	
G+jB (Complex admittance)	Delay	

Checked Coupled Markers - Check the box to turn on the trace coupling.

Cleared Coupled Markers - Clear the box to turn off the trace coupling.

Coupling Method - Check to couple markers by marker number, 1 to 1, 2 to 2 and so forth. [Learn more about Coupling Method.](#)

All Off - Switches OFF all markers on the active trace.

Coupling Method

The coupled markers feature causes markers on different traces to line up with the markers on the selected trace. Markers are coupled by marker number, 1 to 1, 2 to 2, 3 to 3, and so forth. If the x-axis domain is the same (such as frequency or time), coupling occurs either of in a channel or across all channels. Trace markers in a different X-axis domain will not be coupled. If a trace marker has no marker to couple with on the selected trace, the marker remains independent.

All - A marker on one trace is coupled to the same-numbered markers on all channels, all windows and all traces.

Channel - A marker on one trace is coupled to the same numbered markers on traces which share the same channel number as the original trace.

Searching with Markers

You can use markers to search and return data for the following trace criteria:

- [Max and Min](#): Find the highest or lowest points on the trace

- [Peak](#): Move to other peaks (left, right, next highest)
- [Multi Peak](#)
- [Target](#): Find a specific Y-axis value
- [Multi Target](#):
- [Bandwidth](#) (Filters)
- [Notch](#) (Filters)
- [Compression Point](#) (Amplifiers)
- [About PSAT and PNOP Markers](#)
 - [Power Saturation](#) (Amplifiers)
 - [Power Normal Operating Point](#) (Amplifiers)
- [Search Domain](#)
- [Search Range Indicators](#)

How to Search with Markers

<p>Using Hardkey/SoftTab/Softkey</p> <ol style="list-style-type: none"> 1. Press Search > <i>Main / Peak / Target / Multi Peak & Target / Bandwidth & Notch / Compression & Saturation / Normal Op Pt.</i> 	<p>Using a mouse</p> <ol style="list-style-type: none"> 1. Move the cursor on a marker. 2. Right-click on the marker then select Search... to show the Marker Search Dialog box for define the search parameters. 3. From Search Type of Marker Search dialog box, select the desired search function. 4. Press Execute or check Tracking. Learn more.
--	---

Programming Commands

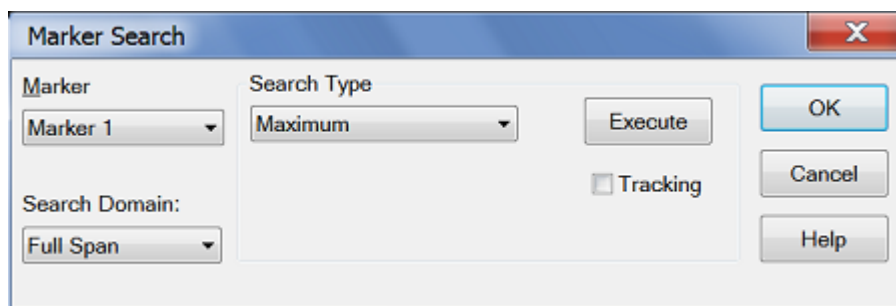

Marker Search Dialog Box / [Search](#) Softtab Help

Marker - Specifies the marker that you are defining. Not available for search types that deploy specific markers.

Search Domain - Defines the area where the marker can move or search. For full span, the marker searches for specified values within the full measurement span. For user span, the marker searches for specified values within a measurement span that you define. [Learn more about Search Domain.](#)

Search Type

Note: You must either press **Execute** or check **Tracking** to initiate all search types. If there is no valid data match for the search type, the marker will not move from its current position.

- **Execute** - Click to cause the marker to search for the specified criteria.
- **Tracking** - Check to cause the marker to search for the specified criteria with each new sweep. The searches begin with the first sweep after Tracking has been checked, based on the current search type and domain information. Therefore, make sure that the search criteria are in the desired state before using the data. You cannot manually change the stimulus setting for a marker if Tracking is selected for that marker.

Tracking operation is different depending on "Marker: Use Single Marker for marker Search" setting in the preferences. When the preference is enabled or disabled, all existing marker searches are turned off and tracking is turned off by default.

On (Checked)	This is the E5071C-compatible mode. The advanced marker search functions (Bandwidth, Notch, Compression, Saturation and Normal Operating Points) are performed by using dedicated small sub-markers which always track the active marker. In this mode, the marker search tracking function cannot be applied to these advanced marker search functions except Compression Search.
Off (unchecked)	This is the PNA (N52xx)-compatible mode. These advanced marker search functions are performed by markers. In the preset condition, the marker search tracking is applied to the advanced marker search function you selected. If you assign the marker search tracking to other marker search function (for example Max tracking), the tracking operation for these advanced marker searches will be disabled.

Maximum - The marker locates the maximum (highest) data value. [Learn more about Maximum Search.](#)

Minimum - The marker locates the minimum (lowest) data value. [Learn more about Minimum Search.](#)

Peak - The marker locates the highest peak or lowest valley. Whether peak or valley is determined by the search polarity: Press **Search > Peak > Peak Polarity**. [Learn more about Peak Search.](#)

- When Peak Polarity is Positive, the marker moves to the maximum peak.
- When Peak Polarity is Negative, the marker moves to the minimum peak.

Peak Right - The marker locates the **next valid peak to the right** of its starting position on the X-axis.

Peak Left - The marker locates the **next valid peak to the left** of its starting position on the X-axis.

Next Peak - The marker locates the peak with the next lower amplitude value relative to its starting position for positive peak search. The next higher valley is searched for negative peak search.

Multi Peak - A function that searches for peaks that match the multi-peak search excursion value and multi-peak polarity value. [Learn more about Multi Peak Search.](#)

- Threshold - Value in dB.
- Excursion - Value in dB.

Target - A function that searches for a target that matches the pre-defined target value and transition types (positive, negative or both (positive and negative)) and then moves the marker to that target. [Learn more about Target Search.](#)

Target Left - A function executes the search from the current marker position to the smaller stimulus values and moves the marker to first target encountered.

Target Right - A function executes the search from the current marker position to the larger stimulus values and moves the marker to first target encountered.

Multi Target - A function that search for targets that are of the multi-target value and multi target transition value. [Learn more about Multi Target Search.](#)

- Target - Value in dB.

Compression - A function used the active marker to find the specified gain Compression Level. [Learn more about Compression Search.](#)

- Compression - Value in dB.

Bandwidth - A function for determining the bandwidth of the trace, center frequency, cut-off points (on the higher frequency and the lower frequency sides), Q and insertion loss based on the position of the active marker. [Learn more about Bandwidth Search.](#)

Notch - A function is used to obtain the bandwidth, center frequency, cutoff points (high-frequency side and low-frequency side), Q and insertion loss of a trace based on the active marker position. [Learn more about Notch Search.](#)

- Level - Bandwidth and notch level in dB.

Power Saturation - [Learn more about PSAT Search.](#)

- PMax Back-off -Value in dB.

Normal Operating Pt - The output power where the input is offset from the back-off input power by the Pin Offset. [Learn more about PNOP Search.](#)

- Back-off - Value in dB.
- Pin Offset - X-axis value in dB.

Maximum and Minimum Search

How to create Maximum and Minimum Search

Using **Hardkey/SoftTab/Softkey**

1. Press **Search** > **Main**.
2. Click **Max Search** or **Min Search**.
3. Optionally click **Tracking** to search for the specified maximum or minimum level with each sweep. [Learn more.](#)

Using a mouse

1. Move a cursor on a marker.
2. Right-click on the marker and then select **Search....**
3. From **Search Type** of Marker Search dialog box, select **Maximum / Minimum**.
4. Press **Execute** or check **Tracking**. [Learn more.](#)

You can search for the maximum or minimum measured value on the trace and move a marker to that point.

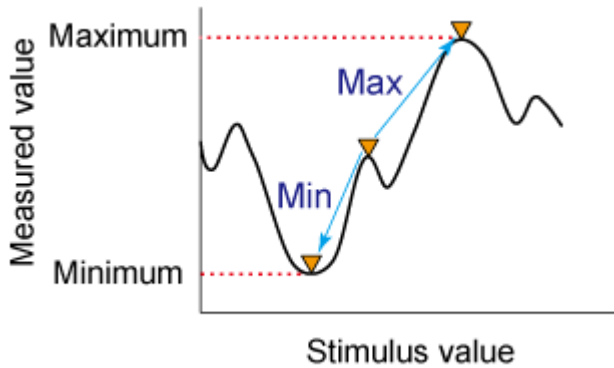

Search for maximum (Max Search)	Move active marker to point on trace where measured value is greatest.
Search for minimum (Min Search)	Move active marker to point on trace where measured value is lowest.

Note: When the data format is in Smith chart or polar format, execute the search only for the main response value.

Peak Search

How to create Peak Search

Using **Hardkey/SoftTab/Softkey**

1. Press **Search > Peak**.
2. Click **Peak Search** to show the markers on the peak.
3. Click **Peak Right >> Search**, **<< Peak Left Search** or **Next Peak Search** to move the marker to the peak.
4. Click **Threshold** to enter the value of peak threshold.
5. Click **Excursion** to enter the lower limit value of peak excursion.
6. Click **Peak Polarity** to select a [peak polarity](#).
7. Optionally click **Tracking** to search for the specified peak level with each sweep. [Learn more](#).

Using a mouse

1. Move a cursor on a marker.
2. Right-click on the marker and then select **Search....**
3. From **Search Type** of Marker Search dialog box, select **Peak / Peak Left / Peak Right / Next Peak**.
4. Enter the value of **Threshold** and **Excursion**.
5. Press **Execute** or check **Tracking**. [Learn more](#).

Programming Commands

A peak is a measurement point whose value is greater or smaller than the adjoining measurement points on its right and left sides. Peaks are classified into the following two types depending on the difference in magnitude from the measurement points on either side of it.

What is "Peak"?

You define what the analyzer considers a "peak" by selecting the following two peak criteria settings:

- **Threshold** - To be considered valid for the positive peak search, the peak must be **above** the threshold level. The valley on either side can be below the threshold level. For negative peak search, valleys below the threshold level are considered valid in the opposite manner.
- **Excursion** - The vertical distance (dB) between the peak and the valleys on both sides. To be considered valid, data values must descend from the peak or ascend from the valley on the both sides by the excursion value.

Peak Polarity:	Definition:
Positive	A peak whose measured value is greater than those of the measurement points on either side of it. Detect positive peaks which are larger than Threshold.
Negative	A peak whose measured value is smaller than those of the measurement points on either side of it. Detect negative peaks which are smaller than Threshold.
Both	A peak whose measured value is smaller and greater than those of the measurement points on either side of it. No detection due to it does not use Threshold.

About Peak Excursion Value

The peak excursion value is the smaller of the differences in measured values from the adjoining peaks of the opposite polarity.

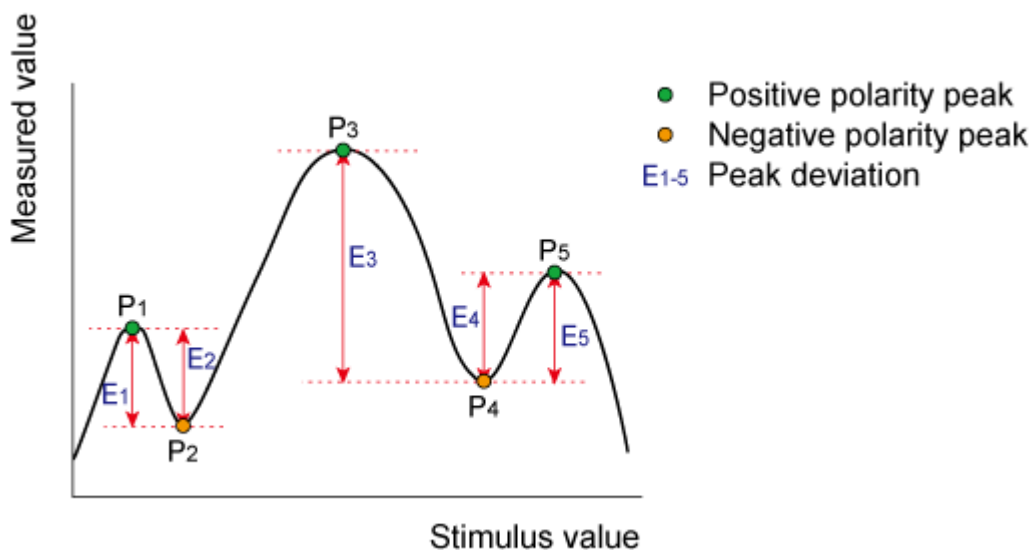

Executing a Peak Search

The following 3 methods are available for executing the peak search:

Next Peak	Moves the marker to the maximum peak when peak polarity is Positive or Both . Moves the marker to the minimum peak when peak polarity is Negative .
Peak Left	Executes the search from current marker position to the smaller stimulus values and moves the marker to first peak encountered.
Peak Right	Executes the search from current marker position to the larger stimulus values and moves the marker to first peak encountered.

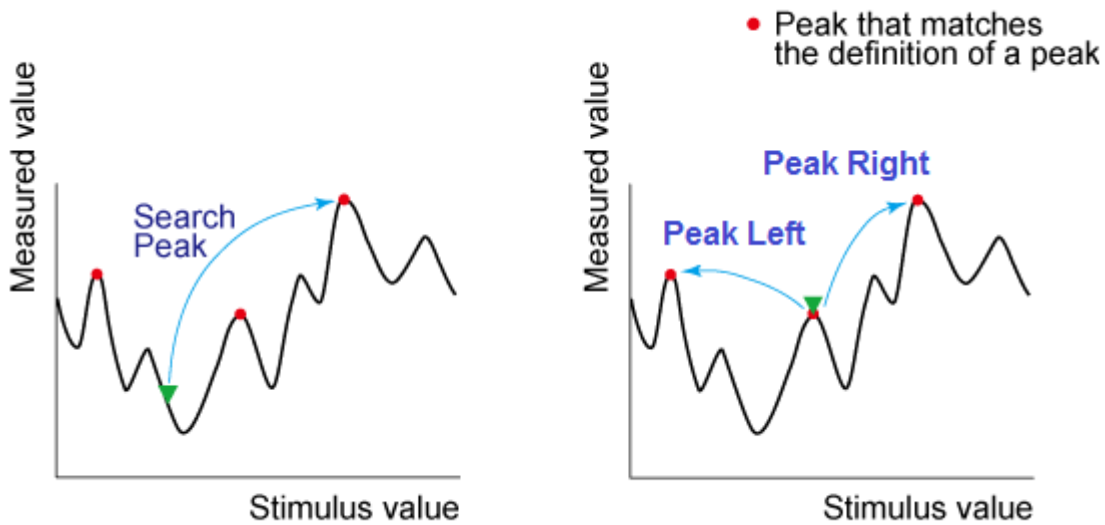

Note: Peak right, peak left and next peak may not be tracked. If these searches are selected and then tracking is turned on, the peak tracking is enabled.

When the data format is in Smith chart or polar format, execute the search for the main response value of the two marker response values.

Changing the settings of [peak excursion value](#) or [peak polarity](#) executes new search for multiple peak.

Example:

Threshold Setting: -10dB

Excursion Setting: 1dB

Scale = 1 dB / Division

Mouse over the graphic to find a valid peak.

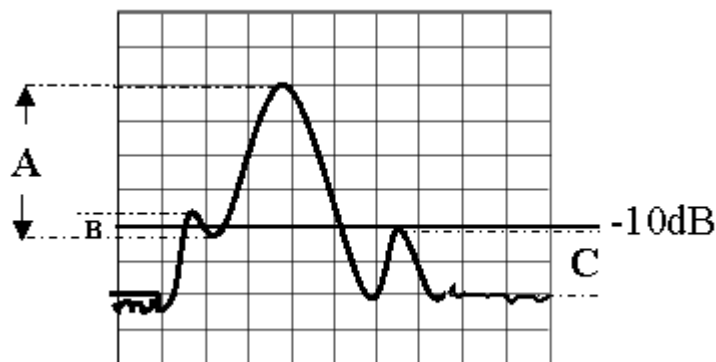

- **Peak A** = Valid Peak (Above Threshold and Excursion Settings)
- **Peak B** = Invalid Peak (Below Excursion Setting)
- **Peak C** = Invalid Peak (Below Threshold Setting)

Multi Peak Search

How to create Multi Peak Search

Using **Hardkey/SoftTab/Softkey**

1. Press **Search** > **Multi Peak & Target**.
2. Click **Multi Peak Search** to show the markers on the multi peaks.
3. Click **Peak Threshold** to enter the value of peak threshold.
4. Click **Peak Excursion** to enter the lower limit value of peak excursion.
5. Click **Peak Polarity** to select a [peak polarity](#).
6. Optionally click **Tracking** to search for the specified multi peak level with each sweep. [Learn more](#).

Using a mouse

1. Move a cursor on a marker.
2. Right-click on the marker and then select **Search...**
3. From **Search Type** of Marker Search dialog box, select **Multi Peak**.
4. Enter the value of **Threshold** and **Excursion**.
5. Press **Execute** or check **Tracking**. [Learn more](#).

Programming Commands

The multi peak search function enables you to display markers on multiple peaks on traces. Depending on the number of detected peaks, markers 1 through 15 are displayed from the start frequency. The reference marker is not affected.

Multiple peak search has [threshold](#), [excursion](#) and [polarity](#) as user defined values. This search may have tracking enabled.

When the multiple peak search is executed, previous markers search and tracking are disabled and the settings for the multiple peak search are used.

Note: Do not use individual marker settings or marker domain.

Put markers on each valid peak, using up to 15 markers.

Target Search

How to create Target Search

Using **Hardkey/SoftTab/Softkey**

1. Press **Search > Target**.
2. Click **Target Search** to enable the target search.
3. Click **Target Right >> Search** or **<< Target Left Search** to move the marker to the target.
4. Click **Target Value** to input the value of target search.
5. Click **Transition** to select a transition type.
6. Optionally click **Tracking** to search for the specified target level with each sweep. [Learn more](#).

Using a mouse

1. Move a cursor on a marker.
2. Right-click on the marker and then select **Search...**
3. From **Search Type** of Marker Search dialog box, select **Target/Target Left/Target Right**.
4. Enter the value of the **Target**.
5. Press **Execute** or check **Tracking**. [Learn more](#).

Programming Commands

The target search is a function that searches for a target that matches the pre-defined target value and transition types (positive, negative or both positive and negative) and then moves the marker to that target.

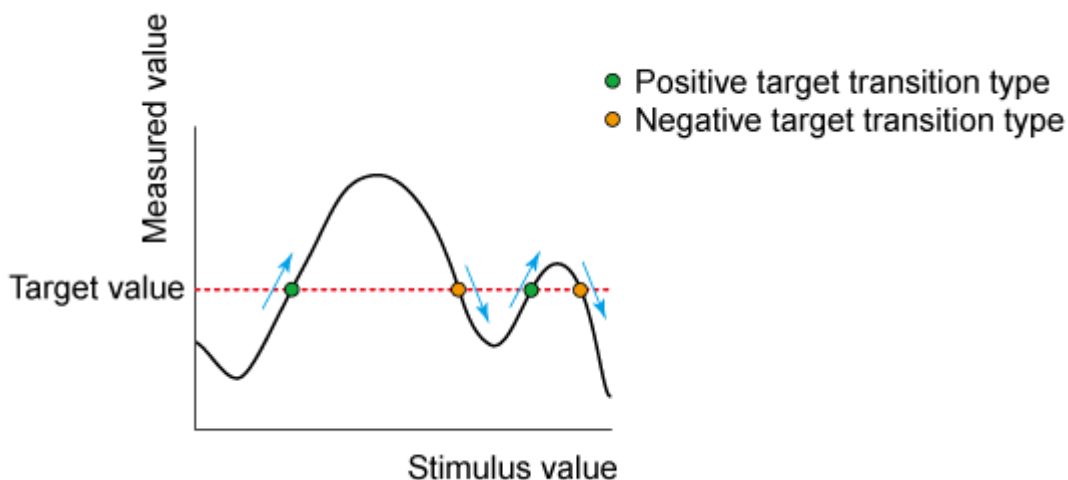

Target Transition Types

A target is a point that has a specific measured value on the trace. Targets can be divided into the 3 groups shown below depending on their transition type.

Transition Type:	Function:
Positive	When the value of the target is larger than the measured value that precedes immediately it (on the right side).
Negative	When the value of the target is smaller than the measured value that precedes immediately it (on the left side).
Both	When the value of the target is smaller or greater than the measured value that precedes immediately it (on the left and

	right side).
--	--------------

Executing a Target Search

The following 2 methods are available for executing the target search:

Target Left	Executes the search from the current marker position to the smaller stimulus values and moves the marker to first target encountered.
Target Right	Executes the search from the current marker position to the larger stimulus values and moves the marker to first target encountered.

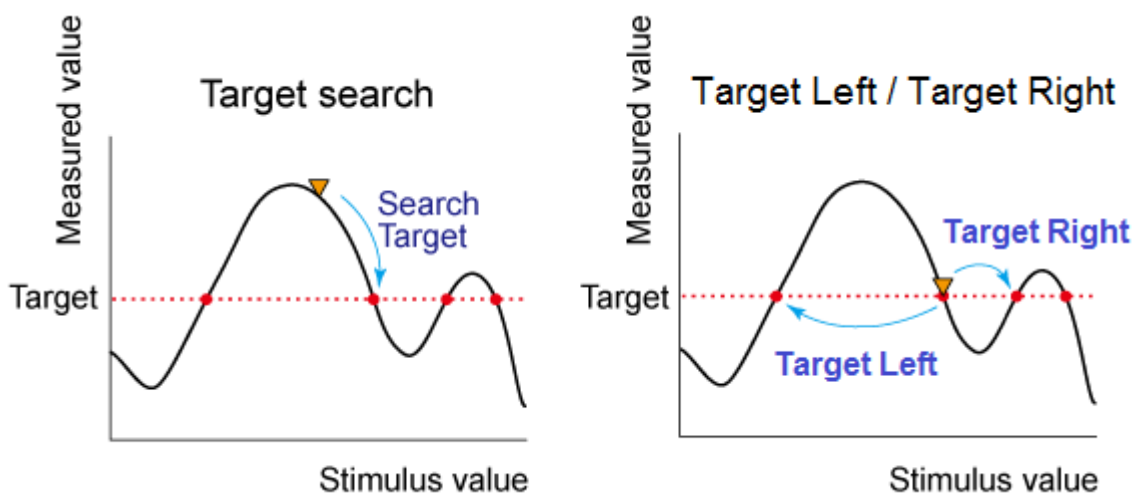

Note: Target right and target left cannot have tracking enabled. If target left or target right is the selected search and then tracking is enabled, target tracking is enabled.

When the data format is in Smith chart or polar format, execute the search for the main response value of the 2 marker response values.

Changing the settings of target value or transition type executes new search for multiple target.

The marker moves to the first occurrence of the Target value to the right of its current position. Subsequent presses of the Execute button cause the marker to move to the next value to the right that meets the Target value. When the marker reaches the upper end of the stimulus range, it will "wrap around" and continue the search from the lower end of the stimulus range (left side of the window).

- If **Discrete Marker** is OFF, the marker locates the interpolated data point that equals the target value.
- If **Discrete Marker** is ON and there are two data points on either side of the target value, the marker locates the data point closest to the Target value

Multi Target Search

How to create Peak Search

Using **Hardkey/SoftTab/Softkey**

1. Press **Search** > **Multi Peak & Target**.

Using a mouse

1. Move a cursor on a marker.

2. Click **Multi Target Search** to show the markers on the multi target.
3. Click **Target Value** to enter the value of target.
4. Click **Transition** to select a transition type.
5. Optionally click **Tracking** to search for the specified multi target level with each sweep. [Learn more](#).

2. Right-click on the marker and then select **Search....**
3. From **Search Type** of Marker Search dialog box, select **Multi Target**.
4. Enter the value of the **Target**.
5. Press **Execute** or check **Tracking**. [Learn more](#).

Programming Commands

The multi target search is a function that searches for targets that match to pre-defined target value and transition types (positive, negative or both of positive and negative) and displays markers on the targets being searched.

Depending on the number of detected targets, markers 1 through 15 are displayed from the start frequency. The reference marker is not affected.

When the multi target search is executed, search and tracking settings for markers 1 through 15 are ignored and the settings for the multi target search are used.

Note: Put markers on each found target value, using up to fifteen markers. Reference marker is not affected. Do not use individual marker settings or marker domain. Search range is applied.

Multiple target search has [target](#) and [transition types](#) as user defined values. This search may have tracking enabled. When this search is executing, previous marker searches are disabled.

Bandwidth and Notch Search

4 markers are automatically deployed to find the first negative or positive bandpass in the selected search domain.

How to create Bandwidth and Notch Search

Using **Hardkey/SoftTab/Softkey**

1. Press **Search** > **Bandwidth & Notch**.
2. Click left side **Bandwidth Search** or **Notch Search** small button to turn it ON/OFF.
3. For Bandwidth search, click **BW Ref To** > **Marker** or **Peak**.
4. For Notch search, click **Notch Ref To** > **Marker** or **Peak**.
5. Specify the **BW Level** or **Notch Level** in dB from the peak or valley where bandwidth / notch is measured.
6. Optionally click **Tracking** to search for the specified bandwidth or notch level with each sweep. [Learn more](#).

Using a mouse

1. Move a cursor on a marker.
2. Right-click on the marker and then select **Search....**
3. From **Search Type** of Marker Search dialog, select **Bandwidth** or **Notch**.
4. Specify the **Level** in dB from the peak or valley where bandwidth / notch is measured.
5. Press **Execute** or check **Tracking**. [Learn more](#).

Programming Commands

Bandwidth Search

The bandwidth search is a function for determining the bandwidth of the trace, center frequency, cut-off points (on the higher frequency and the lower frequency sides), Q and insertion loss based on the position of the active marker. The definitions of the parameters determined through the bandwidth search are shown in below.

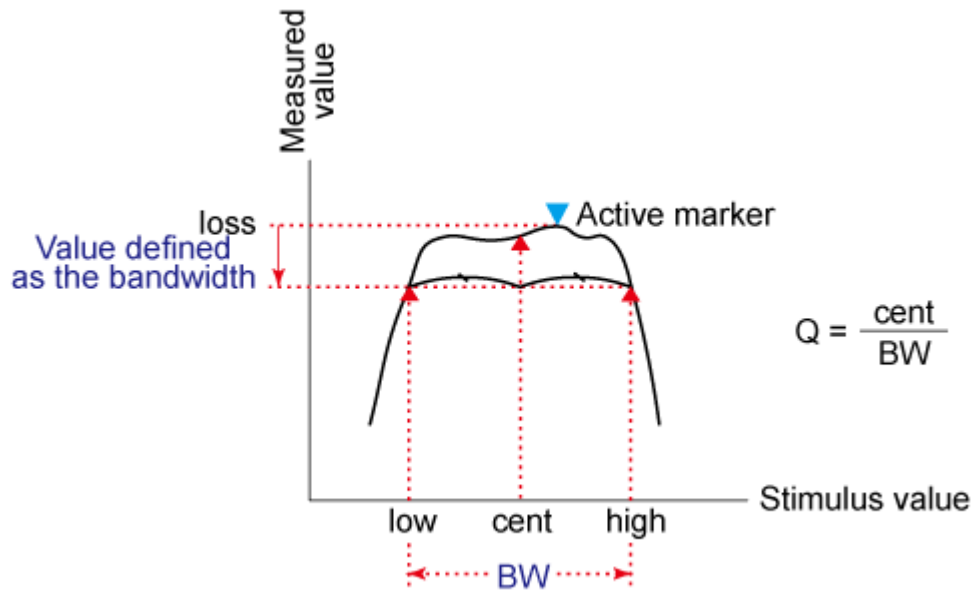

Notch Search

The notch search function is used to obtain the bandwidth, center frequency, cutoff points (high-frequency side and low-frequency side), Q and insertion loss of a trace based on the active marker position. The notch search function starts from the left side of the active marker position and ends when points that meet the conditions are found.

The figure and the table below shows the definition of parameters obtained by notch search function. The notch value in figure below must be specified by the user.

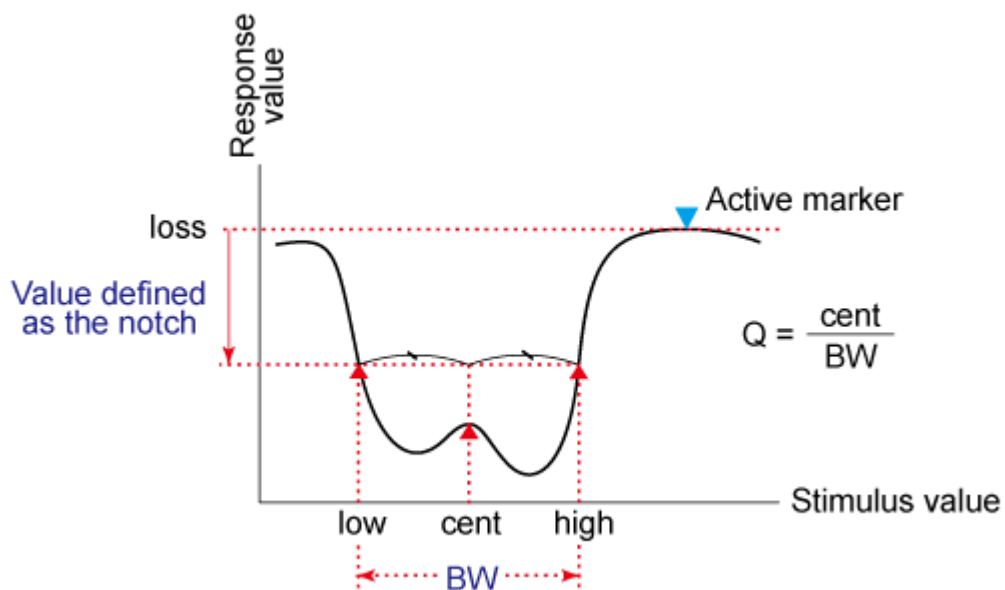

The following values are displayed for Bandwidth and Notch Search:

Bandwidth/Notch Parameter:	Definition:
Bandwidth (BW)	The difference in frequency between the higher frequency cut-off and lower frequency cut-off points (High - Low).
Center frequency (cent)	Frequency at the middle point between the lower frequency cut-off and higher frequency cut-off points. (High + Low)/2.
Lower frequency cut-off point (Low)	Lower frequency of 2 measurement points, both separated by the defined bandwidth / notch value from the active marker position.
Higher frequency cut-off point (High)	Higher frequency of 2 measurement points, both separated by the defined bandwidth / notch value from the active marker position.
Q	Ratio of Center Frequency to Bandwidth (Center Frequency / Bandwidth).
Insertion loss (loss)	The measured value of the position of the center frequency at the time the bandwidth/notch search is executed.

- Bandwidth / Notch Search can be used ONLY with [Log Mag display format](#).
- To use Bandwidth Search on a peak or valley other than the maximum or minimum values, change the [Search Domain](#).

Compression Search

Uses the active marker to find the specified gain **Compression Level**.

Note: Valid ONLY for S21 (Gain) measurements with a [Power Sweep](#).

How to create Compression Search

Using **Hardkey/SoftTab/Softkey**

1. Press **Search** > **Comp & Sat**.
2. Click **Compression Search** to turn ON/OFF.
3. Specify the **Comp Level** in dB.
4. Optionally click **Tracking** to search for the specified compression level with each sweep. [Learn more](#).

Using a mouse

1. Move a cursor on a marker.
2. Right-click on the marker and then select **Search....**
3. From **Search Type** of Marker Search dialog box, select **Compression**.
4. Enter the Y-axis (Power OUT) difference between the first point and the compression marker.
5. Press **Execute** or check **Tracking**. [Learn more](#).

◀ **Programming Commands** ▶

Linear gain is defined as the Y-axis value (gain) of the first data point of the [Search Domain](#) (Full Span by default).



Marker > N - X-axis value and Y-axis value.

Comp Pin - Input power (marker X-axis value).

Comp Pout - Output power (Pin + gain).

Comp Level - Compression level found.

- When [Discrete](#) is **OFF** (default setting), the marker finds the exact specified compression, interpolated between the two closest data points and calculates the Comp Pin and Comp Pout value for that point.
- The marker can move from one actual measurement point to another. Because it is interpolated, it can also move in the space between measurement points.
- When [Discrete](#) is **ON** (not interpolated), the marker resides on the closest data point to the requested compression level.
- A marker moves only between actual measurement points. When a specific marker stimulus value is specified as a numerical value, the marker is placed at the measurement point closest to the specified value. A marker that is placed between interpolated points with the discrete mode off automatically moves to the nearest measurement point when the discrete mode is turned on.

Comp. Not Found - Displayed when the requested compression level is not found.

About PSAT and PNOP Search

Compression measurements based on the Pout vs Pin curves are common in the satellite test industry. In the case of Travelling Wave Tube (TWT) amplifiers, PSAT markers identify the normal operating point near saturation, and the amplifiers are operated with the power slightly backed-off approximately 0.03 to 0.1 dB. For TWT amplifiers, the saturation curve always "folds over" and produces a maximum power out.

For Solid State Power Amplifiers (SSPA), the saturation is not as well defined. A common reference is the Normal Operating Point, which is a power backed-off by 8 to 10 dB from the maximum power. In this case, the normal operating point marker replaces the Psat with the PNOP values. Also, because the backoff is important, the backoff output and input powers are displayed (PBO Out), (PBO in) as well as gain at back off (PBO Gain).

Power Saturation (PSAT) Search

Uses Markers 1, 2, and 3 to quickly identify output power saturation parameters of an amplifier.

Back-off is a point at which the output power is sufficiently lower than the saturated output power so that the device under test behaves in a more linear fashion.

Note: Valid ONLY for Power IN vs Power OUT measurements.

How to make Power IN (X-axis) vs Power OUT (Y-axis) measurement

Using **Hardkey/SoftTab/Softkey**

1. Press **Preset**.
2. Press **Sweep** > **Main** > **Sweep Type**.
3. Select **Power Sweep**.
4. Press **Trace** > **Trace Setup** > **Measure...** and set **Trace Meas** to "B" Receiver
5. Connect DUT input to port 1.
6. Connect DUT output to port 2.

Programming Commands

How to create PSAT Search

Using **Hardkey/SoftTab/Softkey**

1. Press **Search** > **Comp & Sat**.
2. Click left side **Saturation Search** small button to turn ON/OFF.
3. For **PMax Back-Off**, enter the Y-axis (Power OUT) difference between the Max Power marker (3) and the Back-off marker (2).
4. Optionally click **Tracking** to search for the specified power saturation level with each sweep. [Learn more](#).

Using a mouse

1. Move a cursor on a marker.
2. Right-click on the marker and then select **Search** > **Search....**
3. From **Search Type** of Marker Search dialog box, select **Power Saturation**.
4. For **PMax Back-Off**, enter the Y-axis (Power OUT) difference between the Max Power marker (3) and the Back-off marker (2).
5. Press **Execute** or check **Tracking**. [Learn more](#).

Programming Commands

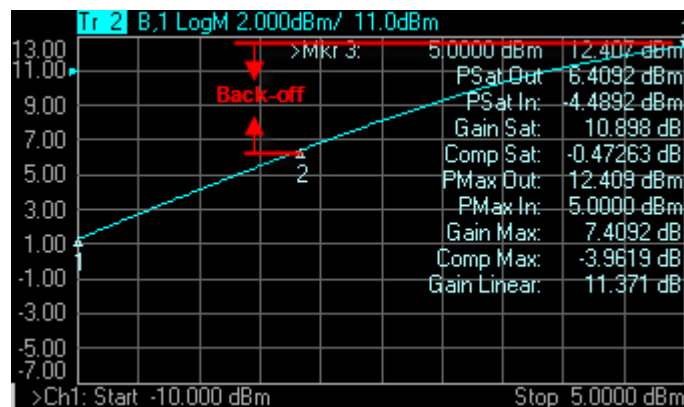

This setting uses **three** markers to calculate and display 10 values.

The three markers:

- Marker 1: Linear gain; the first data point in the sweep.
- Marker 2: Specified output power **Back-off** from max power.
- Marker 3: Max Power output; usually the last data point.

The 9 displayed values:

Param	Description	Calculated from...
PSat Out	Output power at the saturation point.	Marker 2 Y-axis value
PSat In	Input power at the saturation point.	Marker 2 X-axis value
Gain Sat	Gain at the saturation point.	Psat Out - Psat In
Comp Sat	Compression at the saturation point.	Gain Sat - Gain Linear
PMax Out	Maximum output power.	Marker 3 Y-axis value
PMax In	Input power at the maximum output power.	Marker 3 X-axis value
Gain Max	Gain at the maximum output power.	PMax Out - PMax In
Comp Max	Compression at the maximum output power.	Gain Max - Gain Linear
Gain Linear	Linear gain at the first data point.	Marker 1 - Y-axis value MINUS X-axis value

- **Comp. Not Found** is displayed when the requested Back-off point is not found.
- When [Discrete](#) marker is NOT selected (the default setting), the three markers find an interpolated value between the two closest data points.
- When [Discrete](#) marker is selected (NOT interpolated), the three markers reside on the closest data points.

Power Normal Operating Point (PNOP) Search

Uses Markers 1, 2, 3, and 4 to quickly identify Normal Operating Point parameters of an amplifier.

Back-off is a point at which the output power is sufficiently lower than the saturated output power so that the device under test behaves in a more linear fashion.

The power normal operating point is the output power where the input is offset from the back-off input power by the Pin Offset.

Note: Valid ONLY for Power IN vs Power OUT measurements.

See [Power Saturation](#) to learn how to make a Power IN (X-axis) vs Power OUT (Y-axis) measurement.

How to create PNOP Search

Using **Hardkey/SoftTab/Softkey**

1. Press **Search** > **Normal Op Pt.**
2. Click left side **Normal OP Search** small button to turn ON/OFF .
3. For **Back-Off**, enter the Y-axis (Power OUT) difference between the Max Power marker (3)

Using a mouse

1. Move a cursor on a marker.
2. Right-click on the marker and then select **Search** > **Search....**
3. From **Search Type** of Marker Search dialog box, select **Normal Operating**

and the Back-off marker (2).

- For **Pin Offset**, enter the X-axis (Power IN) difference between Back-off marker (2) and PNOP marker (4).
- Optionally click **Tracking** to search for the specified power normal operating point level with each sweep. [Learn more.](#)

Pt.

- For **Back-Off**, enter the Y-axis (Power OUT) difference between the Max Power marker (3) and the Back-off marker (2).
- For **Pin Offset**, enter the X-axis (Power IN) difference between Back-off marker (2) and PNOP marker (4).
- Press **Execute** or check **Tracking**. [Learn more.](#)

Programming Commands

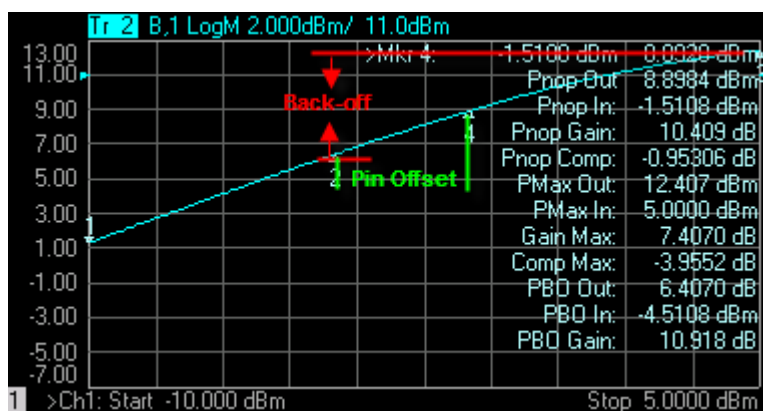

This setting uses **four** markers to calculate and display 12 values.

The **four** markers:

- Marker 1: Linear gain; the first data point in the sweep.
- Marker 2: Max Output Power MINUS the specified Output (Y-axis) **Back-off** value in dB.
- Marker 3: Max Output Power; usually the last data point in the sweep.
- Marker 4: X-axis value of Back-off (Marker 2) plus the **Pin Offset** (X-axis) value in dB.

The 11 displayed values:

Param	Description	Calculated from...
Pnop Out	Output power at the power normal operating point.	Marker 4 Y-axis value
Pnop In	Input power at the power normal operating point.	Marker 4 X-axis value
Pnop Gain	Gain at the power normal operating point.	Pnop Out - Pnop In
Pnop Comp	Compression at the power normal operating point.	Pnop Gain - Linear Gain*
PMax Out	Maximum output power.	Marker 3 Y-axis value
PMax In	Input power at the maximum output power.	Marker 3 X-axis value
Gain Max	Gain at the maximum output power.	PMax Out - PMax In
Comp Max	Compression at the maximum output power.	Gain Max - Linear Gain*
PBO Out	Output power at the back-off point.	Marker 2 Y-axis
PBO In	Input power at the back-off point.	Marker 2 X-axis

PBO Gain	Gain at the back-off point.	PBO Out - PBO In
-----------------	-----------------------------	------------------

***Linear Gain (not shown):** Marker 1 - Y-axis value MINUS X-axis value

- **PNOP Not Found** is displayed when the requested back-off level is not found.
- When [Discrete](#) marker is NOT selected (the default setting), the four markers each find an interpolated value between the two closest data points.
- When [Discrete](#) marker is selected (NOT interpolated), the four markers each reside on the closest data point.

Search Domain

Search domain settings restrict the stimulus values (X-axis for rectangular format) to a specified span. Set the Start and Stop stimulus settings of these **User** spans. If Start is greater than Stop, the marker will not move. [Learn how to set Search Domain](#).

- The default domain of each new marker is "full span".
- There are 16 user-defined domains for every channel.
- The user-defined domains can overlap.
- More than one marker can use a defined domain.
- Search Domain settings are shared with [Trace Statistics User Ranges](#)

The graphic below shows examples of search domains.

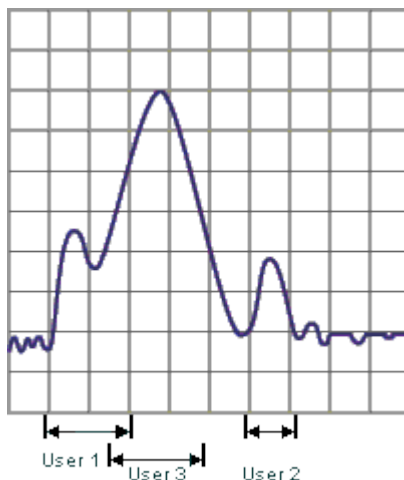

Search Range Indicators

A search range will be indicated with a pair of small, outlined triangles sitting on the X-axis. Although there can be multiple search ranges in use on various markers, only the current-selected search range for the active marker is displayed. This rule prevents the possibility of the X-axis being cluttered with many search range triangles. This rule applies even when there are multiple traces in a window.

Only one search range will be displayed on a grid at any time. The displayed search range will correspond to the active trace and active marker. The color of the range indicators will match that of the active trace.

Range indicators will appear automatically when appropriate and cannot be disabled. The mouse or touchscreen can't be used to "click-and-drag" the position of the range indicators which will alter the search range definition.

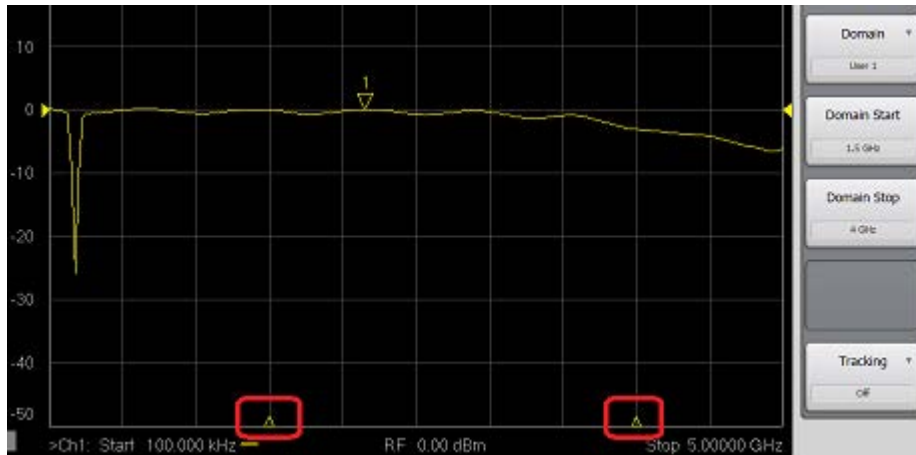

Marker Functions - Change Instrument Settings

The following settings change the relevant VNA settings to the position of the active marker.

How to change Instrument settings using markers

Using **Hardkey/SoftTab/Softkey**

1. Press **Marker** > **Marker->Functions**.

Using a mouse

1. Move a cursor on a marker.
2. Right-click on the marker and then select **Functions**.
3. Select the desired search function.
4. Click **Function...** to show the Marker Function Dialog box.

Programming Commands

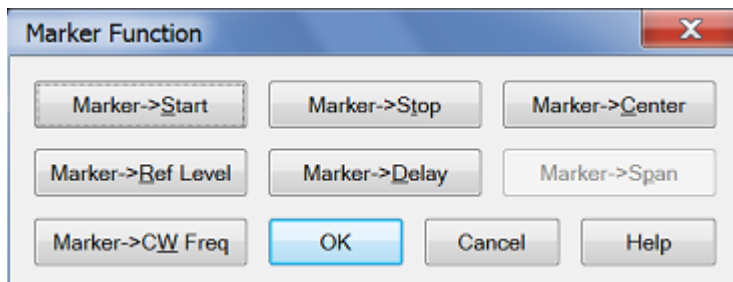

Marker Function Dialog Box Help / **Marker** > **Marker Function** Softtab Help

Marker => Start - Sets the start sweep setting to the value of the active marker.

Marker => Stop - Sets the stop sweep setting to the value of the active marker.

Marker => Center - Sets the center of the sweep to the value of the active marker.

Marker => Ref Level - Sets the screen [reference level](#) to the value of the active marker.

Marker => Delay - The phase slope at the **active marker** stimulus position is used to adjust the line length to the receiver input. This effectively flattens the phase trace around the active marker. Additional Electrical Delay adjustments are required on devices without constant group delay over the measured frequency span. You can use this to measure the electrical length or deviation from linear phase.

This feature adds phase delay to a variation in phase versus frequency. Therefore, it is only applicable for ratioed measurements. See [Measurement Parameters](#).

Marker => Span - Sets the sweep span to the span that is defined by the [delta marker](#) and the marker that it references. Unavailable if there is no delta marker.

Marker => CW Freq - Sets the CW frequency to the frequency of the active marker. NOT available when the channel is in CW or Power Sweep. Use this function to first set the CW Frequency to a value that is known to be within the current calibrated range, then set [Sweep Type](#) to Power or CW.

Note: Some Marker Functions do not work with channels that are in some [Sweep Type](#).

Marker Function	Sweep Type			
	Lin/Log Freq.	Segment	Power	CW Time
Start, Stop, Center	F		S	
Span	S		S	
Ref Level	F	S	S	S
Delay	F	S	S	S
CW Freq.	S	S		

F: Available in both Standard and SMC classes

S: Available in only Standard Class

Marker Display

The marker display dialog allows you to change how markers and the associated readout is displayed on the VNA screen. Several marker display features also apply to [Statistics](#) display.

How to change Marker Display settings

Using **Hardkey/SoftTab/Softkey**

1. Press **Marker** > **Marker Setup** > **Marker Display**....

OR

1. Press **Display** > **Display Settings** > **Customize Display**....

Using a mouse

1. Move a cursor to the marker data area on top right corner of grid box.
2. Right click on the marker data display area.
3. Select **Marker Display**....

2. Select **Markers** tab.

OR

1. Right click on any window area.
2. Click **Customize Display....**
3. Select **Markers** tab.

Programming Commands

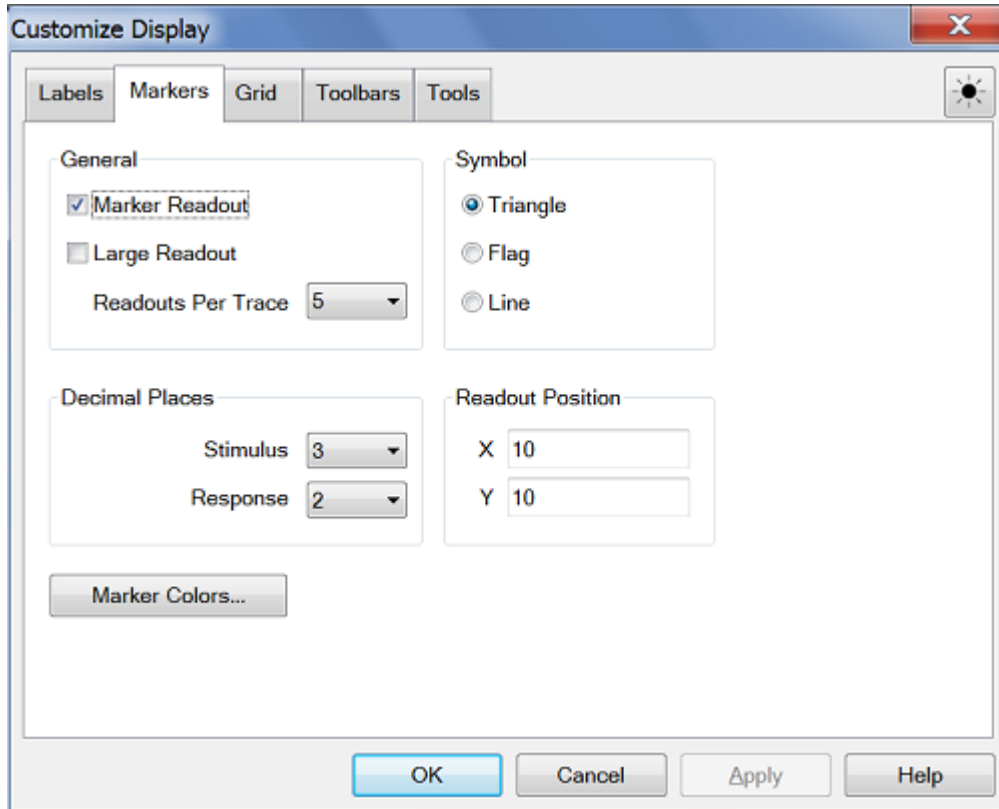

Customize Display Dialog Box Help

The following settings apply to readouts of ALL currently-displayed marker, bandwidth and [trace statistics](#).

These settings revert to their defaults on Preset but ARE stored with [Instrument State](#) and [User Preset](#).

General

Checked **Marker Readout** - Shows readout information.

Cleared **Marker Readout**- Shows NO readout information.

Checked **Large Readout** - Shows the marker readout in large font size for easy reading. However, all readout lines may not be visible.

Cleared **Large Readout** - Shows the marker readout in normal font size.

Readouts Per Trace - Choose the quantity of marker readouts to show in the window for each trace. Choose to display up to 10 readouts per trace, up to 20 readouts per window. When more markers are present than the specified quantity of readouts, the marker numbers for which readouts are displayed can change depending on the marker number that is active. Readouts Per Trace can be set independently for each window.

Symbol - Choose from the following marker symbols.

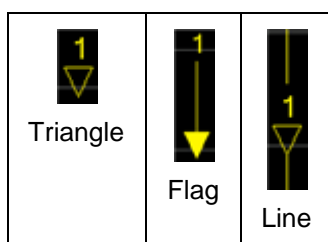

Line symbols are NOT used on Smith or Polar [display formats](#).

Symbols can be set independently for each window.

Decimal Places - Choose the marker readout resolution to display. These values also apply to the readouts that are displayed in the [marker table](#). Decimal Places can be set independently for each window.

Stimulus (X-axis) - Choose from **2** to **6** places after the decimal point. Default is 3.

Response (Y-axis) - choose from **1** to **4** places after the decimal point. Default is 2.

Readout Position - Choose where to place the marker readouts. Marker readouts are right-justified on the specified X-axis and Y-axis position. The default position (10.0, 10.0) is the upper-right corner of the grid. Position (1.0,1.0) is the lower-left corner. Readout position can be set independently for each window.

Note: Readout Position can also be changed using a mouse by left-clicking on the top readout and dragging to the new position.

Marker Colors - Starts the Display Colors dialog with only the marker colors available. [Learn more](#).

Marker Table

You can display a table that provides a summary of marker data for the active trace. The marker data is displayed in the specified format for each marker.

How to view the Marker Table

Using **Hardkey**/**SoftTab**/**Softkey**

1. Press **Marker** > **Marker Setup** > **Marker Table**.

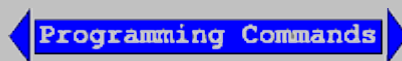

Last Modified:

29-Sep-2015 First Release



Using Math / Memory Operations

You can perform four types of math on the active trace versus a memory trace. In addition three statistics (Mean, Standard Deviation and Peak to Peak) can be calculated and displayed for the active data trace.

- [Trace Math](#)
- [Trace Statistics](#)

Note: Trace Math (described here) allows you to quickly apply one of four math operations using memory traces. [Equation Editor](#) allows you to build custom equations using several types of traces from the same, or different channels.

Other Analyze Data topics

Trace Math

To perform any of the math operations, you must first store a trace to memory. You can display the memory trace using the [View](#) options.

Trace math is performed on the complex data before it is formatted for display. See the VNA data processing map.

Markers can be used while viewing a memory trace.

How to select Trace Math

Using **Hardkey/SoftTab/Softkey**

1. Press **Math > Memory**.

Using a mouse

1. Right click on any trace status area above the grid box.
2. Select on **Memory...**

Normalize, available only from the Memory menu, (not on the Math / Memory dialog), performs the same function as **Data->Memory**, then **Data / Memory**.

◀ **Programming Commands** ▶

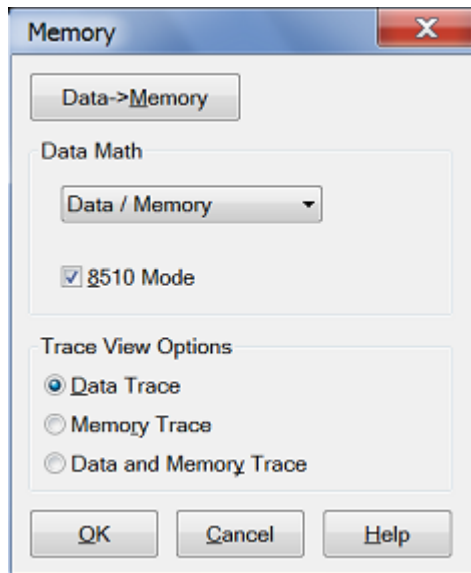

Math > Memory Softtab / Memory Dialog Box Help

Normalize, available only from the Memory menu, (not on the Math / Memory dialog), performs the same function as **Data->Memory**, then **Data / Memory**.

Data->Memory - Puts the active data trace into memory. You can store one memory trace for every displayed trace.

Note: Many VNA features are NOT allowed on Memory traces. For example, Memory traces can NOT be saved to any [file type](#) (PRN, SNP, CTI, CSV, MDF).

Data Math

All math operations are performed on linear (real and imaginary) data before being formatted. See the VNA Data flow (below).

Off - No mathematical operation.

Data / Memory - Current measurement data is divided by the data in memory. Use for ratio comparison of two traces, such as measurements of gain or attenuation. [Learn more](#).

Data - Memory - Data in memory is subtracted from the current measurement data. For example, you can use this feature for storing a measured vector error, then subtracting this error from the DUT measurement. [Learn more](#).

Data + Memory - Current measurement data is added to the data in memory. [Learn more](#).

Data * Memory - Current measurement data is multiplied by the data in memory. [Learn more](#).

8510 Mode - [Learn more](#).

Trace View Options

Data Trace - Displays ONLY the Data trace (with selected math operation applied).

Memory Trace - Displays ONLY the trace that was put in memory.

Data and Memory Trace - Displays BOTH the Data trace (with selected math operation applied), and the trace that was put in memory.

[Learn more about Trace Math](#)

(Data / Memory) and (Data - Memory)

(Data / Memory) and (Data - Memory) math operations are performed on linear data before it is formatted. Because data is often viewed in log format, it is not always clear which of the two math operations should be used. Remember: dividing linear data is the same as subtracting logarithmic data. The following illustrates, in general, when to use each operation.

Use **Data / Memory** for normalization purposes, such as when comparing S21 traces "before" and "after" a change is made or measurement of trace noise. In the following table, the Data/Mem values intuitively show the differences between traces. It is not obvious what Data-Mem is displaying.

S21 values to compare	Data/Mem	Data-Mem
0.5 dB and 0.6 dB	0.1 dB	-39 dB
0.5 dB and 0.7 dB	0.2 dB	-33 dB

Use **Data - Memory** to show the relative differences between two signals. Use for comparison of very small signals, such as the S11 match of two connectors.

In the following table, Data/Mem shows both pairs of connectors to have the same 2 dB difference. However, the second pair of connectors have much better S11 performance (-50 and -52) and the relative significance is shown in the Data-Mem values.

S11 values to compare	Data/Mem	Data-Mem
-10 dB and -12 dB	2 dB	-24 dB
-50 dB and -52 dB	2 dB	-64 dB

Data * Memory and Data + Memory

Use **Data * Memory** and **Data + Memory** to perform math on an active data trace using data from your own formulas or algorithms rather than data from a measurement. For example, if you want to simulate the gain of a theoretical amplifier placed in series before the DUT, you could do the following:

1. Create an algorithm that would characterize the frequency response of the theoretical amplifier.
2. Enter complex data pairs that correspond to the number of data points for your data trace.
3. Load the data pairs into memory with SCPI commands. The analyzer maps the complex pairs to correspond to the stimulus values at the actual measurement points.
4. Use the **data + memory** or **data * memory** function to add or multiply the frequency response data to the measured data from the active data trace.

Note: The data trace must be configured before you attempt to load the memory.

Trace Statistics

You can calculate and display statistics for the active data trace. These statistics are:

- Mean
- Standard deviation
- Peak-to-peak values

You can calculate statistics for the full stimulus span or for part of it by using User Ranges.

You can define up to 16 user ranges per channel. These user ranges are the same as the [Search Domain](#) specified for a marker search in that same channel. They use the same memory registers and thus share the same stimulus spans.

The user ranges for a channel can overlap each other.

A convenient use for trace statistics is to find the peak-to-peak value of passband ripple without searching separately for the minimum and maximum values.

The trace statistics are calculated based on the format used to display the data.

- [Rectangular data formats](#) are calculated from the scalar data represented in the display.
- [Polar](#) or [Smith Chart](#) formats are calculated from the data as it would be displayed in [Log Mag](#) format.

[See how to make Trace Statistics display settings.](#)

How to activate Trace Statistics

Using **Hardkey/SoftTab/Softkey**

1. Press **Math > Analysis > Statistics...**

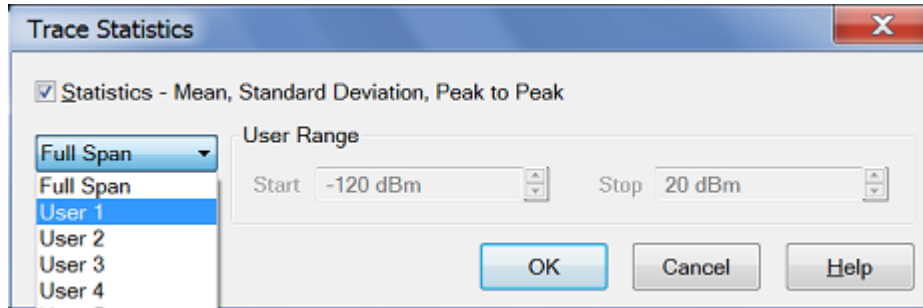
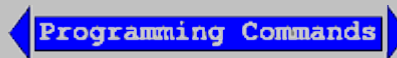

Trace Statistics Dialog Box Help

[See how to make Trace Statistics display settings.](#)

Statistics - Check to display mean, standard deviation, and peak to peak values for the active trace.

Span - Specifies the span of the active trace where data is collected for a math operation. You can select Full Span, or define up to 16 user spans per channel with Start and Stop. You can also define the user spans from the Search Domain selector on the [Marker Search dialog box](#).

User Range

Start - Defines the start of a user span.

Stop - Defines the stop of a user span.

[Learn more about Trace Statistics](#)

Last Modified:

29-Sep-2015 First Release



8510 Mode

On the [Trace Math](#) dialog, check 8510 Mode to simulate the Keysight 8510 data processing chain as it pertains to Trace Math and Memory. This setting applies to all channels. When the box is checked or cleared, the VNA performs an [Instrument Preset](#) and retains its setting through subsequent Instrument Presets.

This setting can be saved as part of an [instrument state](#). However, when recalled, this setting is assumed only temporarily. When a subsequent VNA Preset is performed, the VNA reverts to the setting that was in effect before the state was recalled.

You can set a preference to always use 8510 mode.

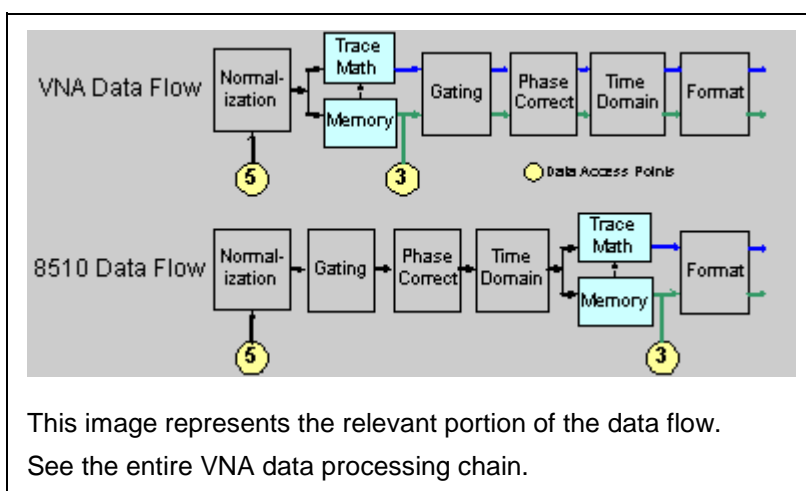

This image represents the relevant portion of the data flow.

See the entire VNA data processing chain.

A settings change in any of the operations that occur after the Memory operation on the above **VNA Data Flow** diagram changes both the Data trace and the Memory trace. For example, after storing a data trace to memory, when you change the format for the Data Trace, the format for the Memory Trace is also changed to the same setting.

How to turn ON/OFF 8510 mode

Using **Hardkey/SoftTab/Softkey**

1. Press **Math** > **Memory** > **8510 Mode**.

No programming are available for this feature

Last modified:

29-Sep-2015 First Release

Equation Editor

Equation Editor allows you to enter an algebraic equation that can mathematically manipulate measured data. The results are displayed as a data trace. Data that is used in the equation can be from the same or different channels.

- [Overview](#)
- [How to start Equation Editor](#)
- [Using Equation Editor](#)
- [Data that is used in Equation Editor](#)
- [Trace Settings, Error Correction and an Example](#)
- [Functions and Constants used in Equation Editor](#)
- [Operators used in Equation Editor](#)
- [Example Equations](#)
- [Saving Equation Editor Data](#)

See Also

Equation Editor and MATLAB

Equation Editor Import Functions

- BestFit.dll
- EqnErrorTerms.dll
- Expansion.dll

Other 'Analyze Data' topics

Overview

Equation Editor allows you to enter an algebraic equation of standard mathematical operators and functions, referencing data that is available in the VNA. Once a valid equation is entered and enabled, the display of the active trace is replaced with the results of the equation, and updated in real-time as new data is acquired. For equations that can be expressed with Equation Editor's supported functions, operators, and data, there is no need for off-line processing in a separate program.

For example, enter the equation $S_{21} / (1 - S_{11})$. The resulting trace is computed as each S_{21} data point divided by one minus the corresponding S_{11} data point. For a 201 point sweep setup, the computation is repeated 201 times, once for each point.

As another example, suppose you want the VNA to make a directivity measurement of your 3-port DUT. This is not a native VNA measurement, but can be achieved using the Equation Editor. The desired result is the sum and difference of LogMag formatted traces, expressed as: $S_{12} + S_{23} - S_{13}$.

Because Equation Editor operates on **unformatted complex data**, the required equation is:

```
DIR = S12 * S23 / S13
```

DIR becomes a display label to help you identify the computed data trace.

On the equation trace, set the format to LogMag.

How to start Equation Editor

How to start Equation Editor

Using **Hardkey/SoftTab/Softkey**

1. Press **Math > Analysis > Equation Editor**.

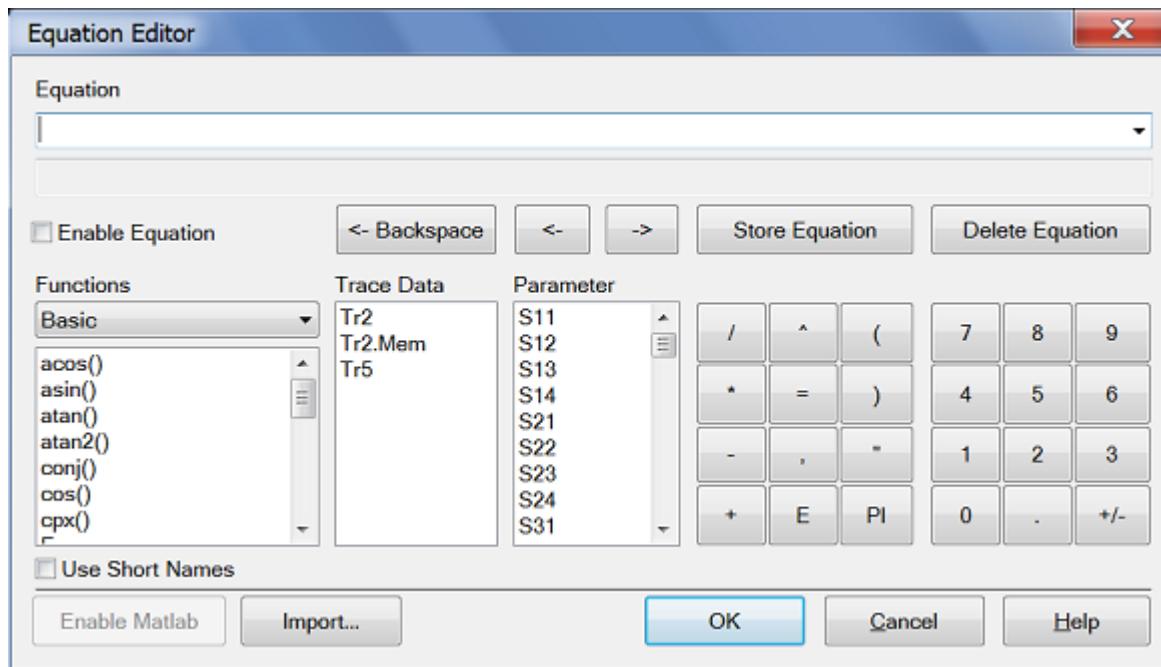
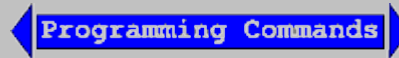

Equation Editor Dialog Box Help

Notes:

- Double-click or type the Functions, Operators and Data to build an Equation.
- Scroll down to learn more about [Using Equation Editor](#).

Equation - The field in which equations are built. Click the down arrow to the right to use or modify equations that have been previously saved. This is where equations are saved when you press 'Store Equation'.

Enabled Equation - Check this box to enable the equation that is currently in the Equation field. If a data trace is used that is from a different channel than the Equation trace, the channels **MUST** have the same number of data points to be valid.

Enabled Equation - Clear this box to disable the equation that is currently in the Equation field. The equation is not valid when the Enabled box is unchecked/not available.

<- Backspace - Moves the cursor to the left while erasing characters.

<- - Moves the cursor to the left without erasing characters.

-> - Moves the cursor to the right without erasing characters.

Store Equation - Press to save the current equation. To later recall the equation, click the down arrow to the right of the equation.

Delete Equation - Removes the current equation from the drop-down list.

Functions - See [descriptions of Functions](#).

Select the "library" of functions to view. The "built-in" library appears by default which includes the standard functions of equation editor. Other functions that can appear here are functions that you have written and imported. [Learn more](#).

Trace Data - Select from ALL of the currently **displayed** traces on ALL channels.

Parameter - Select from **undisplayed** data that is available ONLY from the active channel (same channel as the equation trace). See [Data that is used in Equations](#).

Note: With an external test set enabled, only parameters involving ports 1 through 4 are listed. However, all available parameters can be typed directly into the **Equation** field.

Operators - See [descriptions of Operators](#).

Keypad - Provided to allow navigation of the entire dialog with a mouse.

Use Short Names - Some functions have shortened names that are entered automatically when checked. Both long and short names can be used interchangeably.

Use Short Names - Some functions which have shortened names is manually entered when cleared.

Enable Matlab Available when a full MATLAB version is installed on the VNA. [Learn more](#).

Import... - Click to launch the Import Functions Dialog box.

Using Equation Editor

1. Pick a trace in which to enter the equation.

- Equation Editor works on the active trace.
- Either create a new trace, or click the [Trace Status](#) button on an existing trace to make the trace active.

2. Enter an equation.

Start Equation Editor [See how](#).

- The equation text can be in the form of an expression $(S21)/(1-S11)$ or an equation $(DIR = S12 * S23 / S13)$. This topic refers to both types as equations.
- Either type or double-click the Functions, Operators and Data to build an equation.
- Functions and Constants are case-sensitive; Data names are NOT case sensitive.
- [Learn more about referring to data traces](#).

3. Check for a valid equation.

When a valid equation is entered, the Enabled checkbox becomes available for checking. When the Enabled box is checked:

- The Equation Trace becomes computed data.
- The equation is visible on the [Trace Status](#) (up to about 10 characters).
- If an equation is NOT valid and a trace from a different channel is used, make sure the number of data points is the same for both channels.

[Learn more about the Functions](#), [Operators](#) and [Data](#) that are used in Equation Editor.

Data that is used in Equation Editor

Definitions:

- **Equation trace** - A trace in which an equation resides.
- **Referred trace** - A trace that is used as data in an equation.

Example: $eq=Tr2+S11$ is entered into **Tr1**.

Tr1 becomes an equation trace.

Tr2 and **S11** are both referred traces because they are used in the equation trace.

Notes:

- Referred traces are processed one data point at a time. For example, the expression $S11/S21$ means that for each data point in $S11$ and $S21$, divide point N of $S11$ by point N of $S21$.
- Once an equation is enabled, the trace is no longer identified by its original measurement parameter. It becomes an equation trace.
- An equation trace can NOT refer to itself. For example, an equation in $Tr1$ cannot refer to trace $Tr1$.
- Referred traces can be selected from S-Parameters, Receiver data and [Memory traces](#).
- [See note regarding External Test Sets.](#)

There are three ways to refer to traces:

The following distinction is important when discussing the three ways to refer to traces/data.

- **Trace** - a sequential collection of data points that are displayed on the VNA screen.
- **Data** - VNA measurements that are acquired but not displayed. When an equation trace refers to data that is not displayed, the VNA will automatically acquire the data.

1. Using **TrX** Trace notation (For example, $Tr2$).

When a trace is created, check ["Show Tr Annotation"](#) to see the **Tr** number of that trace.

- **Simple** - ALWAYS refers to displayed traces.
- Must be used for referring to traces in a different channel as the equation trace.
- All [trace settings](#) are preserved in the equation trace. If you do NOT want a trace setting to be used in the equation trace, you must disable it in the referred trace.
- If the referred trace is error corrected, then the data is corrected in the equation trace.
- Used to refer to a memory trace (It must already be stored in memory). Append **.MEM** to the **TrX** trace identifier. For example, **Tr2.mem** refers to the memory trace that is stored for $Tr2$.

2. Using **S-parameter** notation (for example, $S11/S21$).

- **Convenient** - ALWAYS refers to data that is NOT displayed.
- Refers to data that resides in the same channel as the equation.
- NOT the same as referring to a displayed $S11$ trace using **TrX** notation. [See Example](#).
 - The referred data includes NO [trace settings](#).
 - If the channel has error correction available, then it can be applied by turning error correction ON for the Equation trace.

3. Using **Receiver** notation (for example AB_2); NOT case sensitive.

At least one receiver is required, followed by an underscore and a number.

- The **letters** before the underscore refer to the receivers.
 - Letters alone refer to physical receivers.

- Letters immediately followed by numbers refer to logical receivers. [Learn more.](#)
- If two receivers are referenced, they are ratioed.
- The **number** after the underscore refers to the source port for the measurement.

Examples:

- AR1_2 = physical receiver A / physical receiver R1 with 2 as the source port.
- a3b4_1 = reference receiver for port 3 / test port receiver for port 4 with 1 as the source port.

[Learn more about ratioed and unratioed receiver measurements.](#)

Receiver notation is like S-parameter notation in that:

- Refers to data that is NOT displayed and resides in the same channel as the equation.
- The referred data includes NO trace settings.
- If the channel has error correction available for that receiver, then it can be applied by turning error correction ON for the Equation trace.

Referring to Traces in a different channel

When the equation trace refers to a trace on a different channel:

- The trace must already be displayed.
- Must refer to the trace using **TrX** notation.
- The Equation trace and the referred trace MUST have the same number of data points or the Enable checkbox will not be available.
- The Equation trace is updated when the last referred data in the same channel is acquired. Therefore, to prevent 'stale' data from being used, the Equation trace must be on a higher numbered channel than the referred trace. This is because the VNA acquires data in ascending channel number order - first channel 1, then channel 2, and so forth. If the Equation trace is on channel 1, and it refers to a trace on channel 2, the Equation trace will update after channel 1 is finished sweeping, using 'old' data for the channel 2 trace.

Port Extensions and Equation Editor

When using port extension with an equation, turn Fixturing ON to ensure that the underlying parameters have port extension properly applied.

Trace Settings, Error Correction and an Example

This discussion highlights the differences between using **S-parameter/Receiver** notation and **TrX** notation when referring to traces. The key to understanding the differences is realizing that **S-parameter/Receiver** notation ALWAYS refers to data that is NOT displayed.

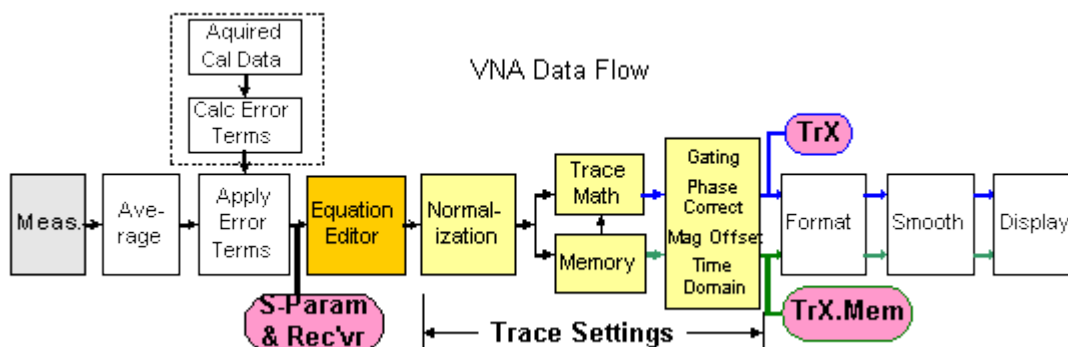

- **Trace Settings** - Normalization, Trace Math, Gating, Phase and Mag Offset, Electrical Delay, Time Domain.
- **Equation Editor** - processing occurs on the **equation trace** immediately after error correction.
- **Referred Data/Trace** (used in the equation) is taken from the following locations:
 - When using **TrX** notation, data is taken immediately before formatting. These traces are always displayed and include [Trace settings](#).
 - When using **S-parameter/Receiver** notation, data is taken immediately after error correction. This data is NOT displayed and includes **NO** trace settings ([see example](#)).

Error-correction and Equation Editor

Using **TrX** notation:

- The Trace Settings and Error-correction on the referred trace are used in the Equation trace.
- If error correction is NOT ON, then the raw, uncorrected data is used in the equation trace.
- To see if error correction is ON, make the trace active, then see the [Correction level in the status bar](#).
- Turning error correction ON/OFF on the equation trace has no meaning. The referred data that is used in the equation is ALWAYS what determines its level of correction.

Using **S-parameter** and **Receiver** notation:

- Because the data is not displayed, NO trace settings are used in the Equation trace.
- Correction can be turned ON/OFF if corrected data is available for the referred data. Exception: When using S-parameter and Receiver notation to refer to a trace on a channel that has been calibrated with a [Response Cal](#) or Receiver Cal, correction can NOT be turned ON, even though the Status Bar indicates otherwise. For example: Tr1 is an S11 measurement with a Response Cal. Tr2 is an equation trace that refers to S11. The Tr2 equation trace is NOT corrected, even though the Status Bar may indicate that it is corrected. However, if Tr2 refers to Tr1 (not S11), the Tr2 equation trace is corrected.

Example

This example illustrates the differences when referring to a trace using **S-parameter** notation and **TrX** notation:

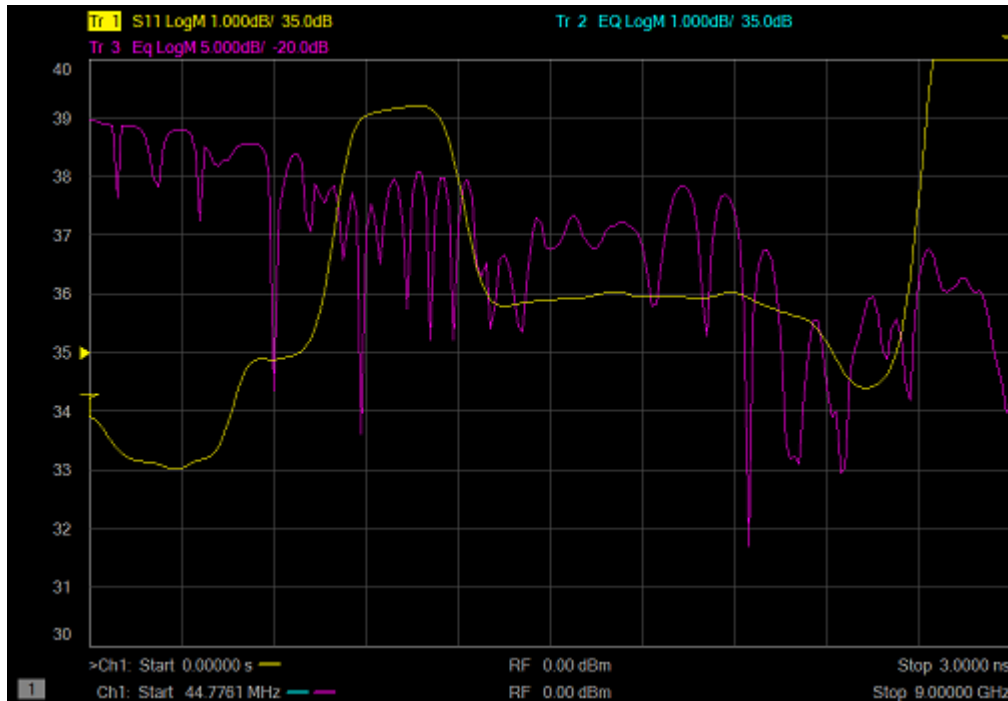

- **Tr1** is an S11 measurement with no equation, conversion ON and Time Domain transform ON.
- **Tr2** is an equation trace that refers to **Tr1**. Tr2 is corrected because Tr1 is corrected. Tr2 is transformed because Tr1 is transformed. If transform is turned ON for Tr2, the data will be transformed AGAIN, which results in "unusual" data.
- **Tr3** is an equation trace that refers to **S11**. This is NOT the same as referring to Tr1. The S11 trace that is referred to is a different instance of S11 that is NOT displayed, and has NO trace settings. Notice that Tr3 data is NOT transformed, although Tr1 is transformed. Correction for **Tr3** can be turned ON and OFF because a calibration was performed on the channel in which the S11 trace resides.
- **Note:** X-axis annotation of the Equation trace is completely independent of the data that is presented. ONLY the **data values** from a referred trace are used. For example, notice that the Equation trace **Tr2** has Frequency on the X-axis although the referred trace **Tr1** is presented in Time.

Functions and Constants used in Equation Editor

ALL trace data that is used in Equation Editor is unformatted, complex data.

When using a mouse with the VNA, hover over a function in the dialog to learn how it is used.

In the following table,

- Function(scalar x) means that an automatic conversion from a complex number to its scalar magnitude is performed before passing the value to the function.
- Function(complex x) means that the entire complex value is used.
- **a, b, c, d** are arguments that are used in the function.

Function	Description
----------	-------------

<code>acos</code> (scalar <i>a</i>)	returns the arc cosine of a in radians
<code>asin</code> (scalar <i>a</i>)	returns the arc sine of a in radians
<code>atan</code> (scalar <i>a</i>)	returns the arc tangent of a in radians
<code>atan2</code>	returns the phase of complex a = (re,im) in radians has the following two argument sets: <ul style="list-style-type: none"> • <code>atan2</code>(complex <i>a</i>) - returns the phase in radians • <code>atan2</code>(scalar <i>y</i>, scalar <i>x</i>)
<code>conj</code> (complex <i>a</i>)	takes a and returns the complex conjugate
<code>cos</code> (complex <i>a</i>)	takes a in radians and returns the cosine
<code>cpx</code> (scalar <i>a</i> , scalar <i>b</i>)	returns a complex value (a+ib) from two scalar values
<code>e</code>	returns the constant $\approx 2.71828\dots$
<code>exp</code> (complex <i>a</i>)	returns the exponential of a
<code>getNumPoints</code> ()	returns the number of points for the current sweep
<code>im</code> (complex <i>a</i>)	returns the imag part of a as the scalar part of the result (zeroes the imag part)
<code>kfac</code> (complex <i>a</i> , complex <i>b</i> , complex <i>c</i> , complex <i>d</i>) when entered in EE: <code>kfac</code> (S11,S21,S12,S22)	k-factor: $k = (1 - a ^2 - d ^2 + a*d - b*c ^2) / (2 * b*c)$ returns a scalar result - the imaginary part of the complex result is always 0
<code>ln</code> (complex <i>a</i>)	returns the natural logarithm of a
<code>log10</code> (complex <i>a</i>)	returns the base 10 logarithm of a
<code>mag</code> (complex <i>a</i>)	returns $\sqrt{a.re*a.re + a.im*a.im}$
<code>max</code> (complex <i>a</i> , complex <i>b</i> , ...)	returns the complex value that has the largest magnitude of a list of values.
<code>max_hold</code> (complex <i>a</i>)	holds the current maximums of the sweep. Disable the equation to reset. See example
<code>median</code> (complex <i>a</i> , complex <i>b</i> ,...)	returns the median of a list of complex values <ul style="list-style-type: none"> • The median is determined by sorting the values by magnitude, and returning the middle one. • If an even number of values is passed, then the smaller of the two middle values is returned.
<code>min</code> (complex <i>a</i> , complex <i>b</i> , ...)	returns the complex value that has the smallest magnitude of a list of values.

min_hold(complex a)	holds the current minimums of the sweep. Disable the equation to reset. See example
mrkx(a)	returns the x-axis value of the active marker on trace a.
mrky(a)	returns the y-axis value of the active marker on trace a.
mu1(complex a, complex b, complex c, complex d) when entered in EE: mu1(S11,S21,S12,S22)	$\mu_1 = (1 - a ^2) / (d - \text{conj}(a) * (a*d-b*c) + b*c)$
mu2(complex a, complex b, complex c, complex d) when entered in EE: mu1(S11,S21,S12,S22)	$\mu_2 = (1 - d ^2) / (a - \text{conj}(d) * (a*d-b*c) + b*c)$
for both mu1 and mu2 (Usually written with the Greek character μ)	<ul style="list-style-type: none"> • conj is the complex conjugate. For scalars a and b, conj(a+ib) = (a-ib) • returns a scalar result - the imaginary part of the complex result is always 0
phase(complex a)	returns atan2(a) in degrees
PI	returns the numeric constant pi (3.141592), which is the ratio of the circumference of a circle to its diameter
pow(complex a,complex b)	returns a to the power b
re(complex a)	returns the scalar part of a (zeroes the imag part)
sin(complex a)	takes a in radians and returns the sine
sqrt(complex a)	returns the square root of a , with phase angle in the half-open interval (-pi/2, pi/2]
tan(complex a)	takes a in radians and returns the tangent
traceDataArray(complex a)	returns the entire set of points from a sweep. Function is intended to be used as an argument in an custom function to allow access for data array processing.
xAxisArray()	returns the x-axis values for the entire sweep.
xAxisIndex()	returns the current index in the sweep.
xAxisValue()	returns the current value of the x-axis index.

Operators used in Equation Editor

Operator	Description
+	Addition

-	Subtraction
*	Multiplication
/	Division
(Open parenthesis
)	Close parenthesis
,	Comma - separator for arguments (as in S11, S22)
=	Equal (optional)
E	Exponent (as in 23.45E6)

Example Equations

The following examples may help you get started with Equation Editor.

Offset each data point in Tr2 from Tr1 by 2dB

Use the function: `pow(complex a, complex b)` -- returns **a** to the power **b**.

$$20\log(a) + 2 = 20\log(x)$$

$$\log(a) + 2/20 = \log(x) \text{ // divide all by 20.}$$

$$x = 10^{(\log(a) + 2/20)} \text{ // swap sides and take 10 to the power of both sides}$$

$$x = 10^{\log(a)} * 10^{(2/20)}$$

$$x = a * 10^{(2/20)}$$

The equation is entered into Tr2 as:

$$\text{Offset} = \text{Tr1} * \text{pow}(10, 2/20)$$

To offset by 5 dB

$$\text{Offset} = \text{Tr1} * \text{pow}(10, 5/20).$$

Balanced Match using a 2-port VNA

$$\text{SDD11} = (\text{S11} - \text{S21} - \text{S12} + \text{S22}) / 2$$

Conversion loss

$$\text{B}_1 / \text{pow}(10, -15/20)$$

- B_1 is a receiver measurement;
- -15 is the input power in dBm

Third-order intercept point (IP3 or TOI)

$$\text{TR1} * \text{sqrt}(\text{Tr1} / \text{Tr3})$$

- Tr1 = input signal power
- Tr3 = intermodulation power (both traces measured with single receivers)

Harmonics in dBc

$$\text{B}_1 / \text{Tr2}$$

- B_1 is tuned to a harmonic frequency
- Tr2 = power at fundamental frequency, measured with B_1 receiver

PAE (Power Added Efficiency)

$$\text{Pout} - \text{Pin} / \text{Pdc}$$

Type the following equation into a new trace with an unratioed measurement, such as A11. The data format is REAL:

```
PAE = 100 * (.001*pow(mag(Tr1),2) -
(.001*pow(mag(Tr1),2)/pow(mag(Tr2),2)))/(Tr3*Tr4)
```

Where:

- Tr1 - a trace that measures unratioed B receiver.
- Tr2 - a corrected S21 trace (amplifier gain)
- Tr3 - a trace that measures ADC voltage (A11) across a sensing resistor.
- Tr4 - an equation trace containing $I_{supp} = (Tr3 / \text{value of sensing resistor})$.

Data is displayed in Real format with units actually being watts.

1-port Insertion Loss

When it is not possible to connect both ends of a cable to the VNA, a 1-port insertion loss measurement can be made. However, the measured loss must be divided by 2 because the result includes the loss going down **and** coming back through the cable. This assumes that the device is terminated with a short or open to reflect all of the power. The 'divide by 2' operation (for dB) is performed as follows using Equation Editor:

Tr1 - an S11 trace in log mag format.

Tr2 - an equation trace containing `sqrt(Tr1)`.

Max and Min Hold

These two functions allow you to capture and display either the Maximum or Minimum values for each data point over multiple sweeps.

Maxhold(S21) - displays the maximum value for each data point until reset. Reset by disabling, then enabling the equation. This example refers to an S21 trace that is not displayed.

Saving Equation Editor Data

Equation data can be saved to the VNA hard drive in the following formats:

- [Citifile \(.cti\)](#) - Equation data is saved and recalled. The file header indicates the "underlying" s-parameter trace type.
- [PRN](#) - read by Spreadsheet software. Can NOT be recalled by the VNA.
- [CSV](#) - read by Spreadsheet software. Can NOT be recalled by the VNA.
- [MDIF](#) - compatible with Keysight ADS (Advanced Design System). Can NOT be recalled by the VNA.
- [Print to File](#) (bmp, jpg, png) - saves image of VNA screen.

Equation data can NOT be saved in [.SnP file format](#). When attempting to save an Equation trace in .SnP format, the "underlying" S-parameter data is saved; not Equation data.

Last Modified:

29-Sep-2015 First Release



Using Limit Lines

Limit lines allow you to compare measurement data to performance constraints that you define.

- [Overview](#)
- [Create and Edit Limit Lines](#)
- [Display and Test with Limit Lines](#)
- [Limit Test Setup](#)
- [Point Limit Test](#)
- [Saving/Recalling Limit Table](#)
- [Displaying Judgement Result of Limit Test](#)
- [Test with Sufficient Data Points](#)

Other Analyze Data topics

Overview

Limit lines are visual representations on the VNA screen of the specified limits for a measurement. You can use limit lines to do the following:

- Give the operator **visual guides** when tuning devices.
- Provide **standard criteria** for meeting device specification.
- Show the **comparison** of data versus specifications.

Limit testing compares the measured data with defined limits, and provides optional **Pass or Fail** information for each measured data point.

You can have up to **100** discrete lines for each measurement trace allowing you to test all aspects of DUT response.

Limit lines and limit testing are NOT available with **Smith Chart** or **Polar** display format. If limit lines are ON and you change to Smith Chart or Polar format, the analyzer will automatically disable the limit lines and limit testing.

Create and Edit Limit Lines

You can create limit lines for all measurement traces. The limit lines are the same color as the measurement trace.

Limit lines are made up of discrete lines with four coordinates:

- BEGIN and END stimulus - X-axis values.
- BEGIN and END response - Y-axis values.

Limit Table

How to turn ON/OFF Limit Table

Using **Hardkey/SoftTab/Softkey**

1. Press **Math > Analysis**.

- Click **Limit Table** to turn ON/OFF the Limit Table.

Programming Commands

	TYPE	BEGIN STIMULUS	END STIMULUS	BEGIN RESPONSE	END RESPONSE
1	MIN	5.600000 GHz	7.500000 GHz	-30.000000 dB	-30.000000 dB
2	MAX	4.700000 GHz	5.800000 GHz	-10.000000 dB	-10.000000 dB
3	MAX	6.200000 GHz	8.000000 GHz	-10.000000 dB	-10.000000 dB
4	OFF	0.000000 Hz	0.000000 Hz	0.000000 dB	0.000000 dB

Note: To ADD a limit line to the table, change the last limit line to either MAX or MIN.

- In the **Type** area of the Limit Table, select **MIN** or **MAX** for Limit Line 1.
 - The MIN value will fail measurements BELOW this limit.
 - The MAX value will fail measurements ABOVE this limit.
- Click **BEGIN STIMULUS** for Limit Segment 1. Enter the desired value.
- Click **END STIMULUS** for Limit Segment 1. Enter the desired value.
- Click **BEGIN RESPONSE** for Limit Segment 1. Enter the desired value.
- Click **END RESPONSE** for Limit Segment 1. Enter the desired value.
- Repeat Steps 1-5 for each desired limit line.

Display and Test with Limit Lines

After creating limit lines, you can choose to **display** or **hide** them for each trace. The specified limits remain valid even if limit lines are not displayed.

Limit testing cannot be performed on memory traces.

You can choose to provide a visual and/or audible PASS/FAIL indication.

With limit testing turned ON:

- Any portion of the measurement trace that **fails** is **displayed in red**.
- Any portion of the measurement trace that does **NOT fail** remains unchanged and silent.

Display failed trace points or trace segments

You can display the data points that fail limit line testing as red dots or as a red trace segment. The default behavior can be changed with a Preference setting. Learn how.



Red Dots

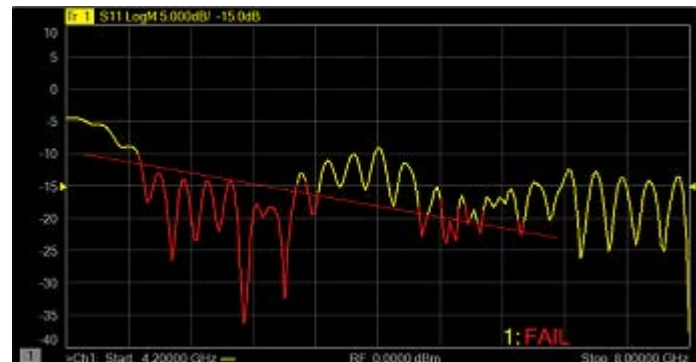

Red Trace Segment

PASS is the default mode of PASS/FAIL testing.

A data point will FAIL only if a measured point falls outside of the limits.

- If the limit line is set to OFF, the entire trace will PASS.
- If there is no measured data point at a limit line stimulus setting, that point will PASS.

Limit Test Setup

How to set Limit Test Setup

Using **Hardkey/SoftTab/Softkey**

1. Press **Math > Analysis**.
2. Click **Limit...** and then select **Limit** tab on the dialog box.

← **Programming Commands** →

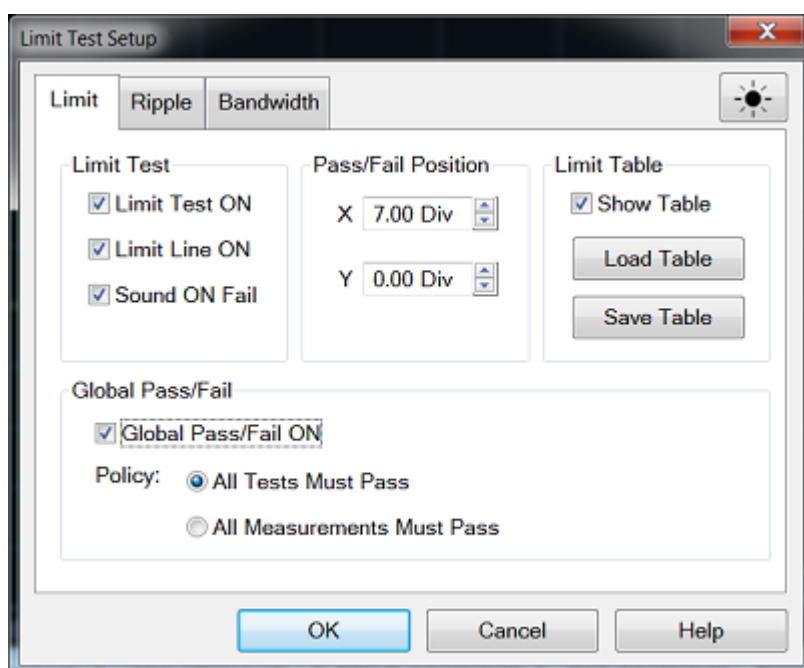

Limit Test Setup Dialog Box Help

Limit Test

Limit Test ON - Check the box to compare the data trace to the limits and display PASS or FAIL.

Limit Line ON - Check the box to make the limits visible on the screen (Testing still occurs if the limits are not visible).

Sound ON Fail - Check the box to make the VNA beep when a point on the data trace fails the limit test.

Pass/Fail Position

X - Set the X-axis position for the PASS or FAIL.

Y - Set the Y-axis position for the PASS or FAIL.

Limit Table

Show Table - Check the box to show the table that allows you to create and edit limits.

Load Table - Recall the saved limit table. [Learn more.](#)

Save Table - Save the limit table. [Learn more.](#)

Note: To ADD a limit line to the table, change the last limit line to either MAX or MIN.

Global Pass/Fail

The Pass/Fail indicator provides an easy way to monitor the status of ALL measurements.

Global Pass/Fail ON - Check to display the Global Pass/Fail status.

Policy: Choose which of the following must occur for the Global Pass/Fail status to display PASS:

- **All Tests (with Limit Test ON) Must Pass** - This setting reads the results from the Limit Tests. If all tests (with **Limit Test ON**) PASS, then the Global Pass/Fail status will PASS.
- **All Measurements Must Pass** - This more critical setting shows FAIL unless all measured data points fall within established test limits **and** Limit Test is ON.

Note: In this mode, if one measurement does NOT have **Limit Test ON**, Global Pass/Fail will show FAIL.

[Learn more about displaying and testing with Limits](#)

Saving/Recalling Limit Test Table

The limit test table can be saved in a file and recalled later for use on the screen. The file is saved in the csv format (with the extension *.csv), and values are saved as a character string with the unit. The csv formatted file can also be reused in spreadsheet software made for PCs.

How to turn Save or Load Limit Test Table

Using **Hardkey/SoftTab/Softkey**

1. Press **Math > Analysis**.
2. Click **Limit...** and then select **Limit** tab on the dialog box.
3. Click **Load Table** to recall the saved Limit Table.
4. Click **Save Table** to save the Limit Table.

No Programming are available for this feature

Load Table

1. To recall the saved limit table, click **Load Table** from the Limit Test Setup dialog and a Recall dialog box is open. At this time, CSV Files (with the extension *.csv) is selected as the file type.
2. Specify the folder that contains the file and then select the file. Click **Recall** to recall the saved limit table on the screen.

Note: You can recall a limit table from a trace on any channel independently of the channel and trace that were active when the limit table was saved to the file.

Save Table

1. To save the limit table, click **Save Table** from the Limit Test Setup dialog and a Save As dialog box is open. At this time, CSV Files (with the extension *.csv) is selected as the file type.
2. Specify any folder in which you want to save the file and enter the file name. Click **Save** to save the limit table displayed on the screen to a file.

The limit table is saved in the following format:

- First line indicates the type of limit test of the instrument.
- Second line indicates the revision of the limit test.
- Third line indicates a header for the segment items that are output from the fourth line onward.
- From the fourth line onward, the segment data are output.

Sample Limit table saved format:

"# E5080 Limit Test"

"# Revision: 1.00"

TYPE, BEGIN STIMULUS, END STIMULUS, BEGIN RESPONSE, END RESPONSE

MIN, 5.600000 GHz, 7.500000 GHz, -30.000000dB, -30.000000dB

MAX, 4.700000 GHz, 5.800000 GHz, -10.000000dB, -10.000000dB

MAX, 6.200000 GHz, 8.000000 GHz, -10.000000dB, -10.000000dB

OFF, 0.000000 Hz, 0.000000 Hz, 0.00dB

Displaying Judgement Result of Limit Test

Judgment result of measurement points and trace

Measurement points that fail are displayed in red on the screen. The judgment result of the trace is indicated by Pass or Fail displayed at the right bottom of screen by default and its position can be edited.

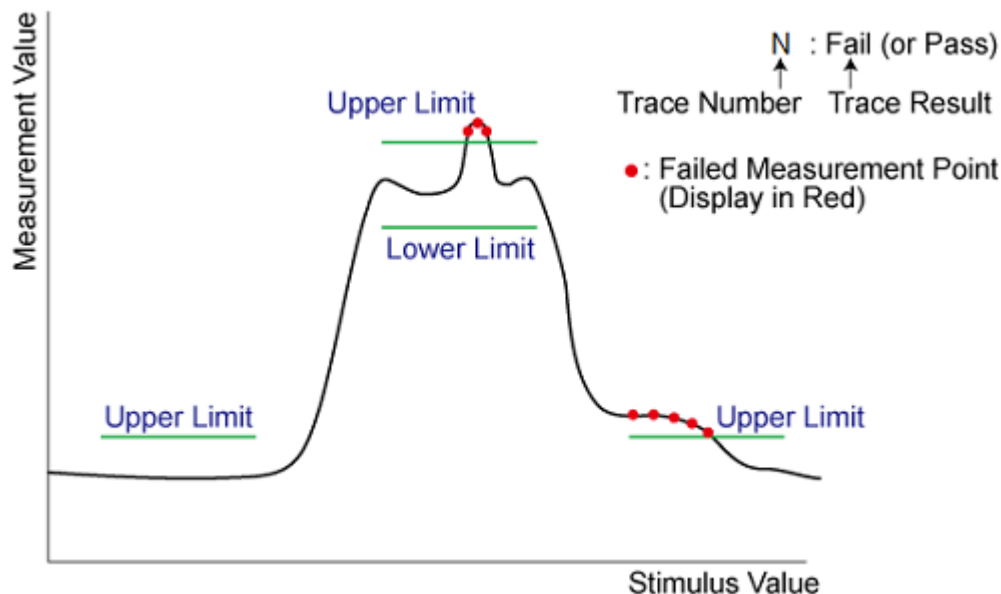

Judgment Result of Channels

If a channel has a judgment result of fail, the result is displayed at Global Pass/Fail dialog box when the [Global Pass/Fail ON](#) is checked (ON). It will be judged as failed if one or more unsatisfactory trace exists in any of the limit test within the channel.



How to turn ON/OFF Global Pass/Fail

Using **Hardkey/SoftTab/Softkey**

1. Press **Math** > **Analysis**.
2. Click **Limit...** and then select **Limit** tab on the dialog box.
3. Checked the box to turn ON the Global Pass/Fail.
4. Clear the box to turn OFF the Global Pass/Fail.

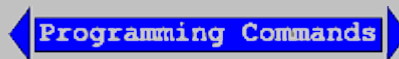

Test with Sufficient Data Points

When **System** > **System Setting** > **Preference, Limit: Test nearest measurement point** is NOT checked, Limits are checked only at the actual measured data points. Therefore, it is possible for a device to be out of specification without a limit test failure indication if the data point density is insufficient.

The following image is a data trace of an actual filter using 11 data points (approximately one every vertical graticule). The filter is being tested with a minimum limit line (any data point under the limit line fails).

Although the data trace is clearly below the limit line on both sides of the filter skirts, there is a PASS indication because there is no data point being measured at these frequencies.

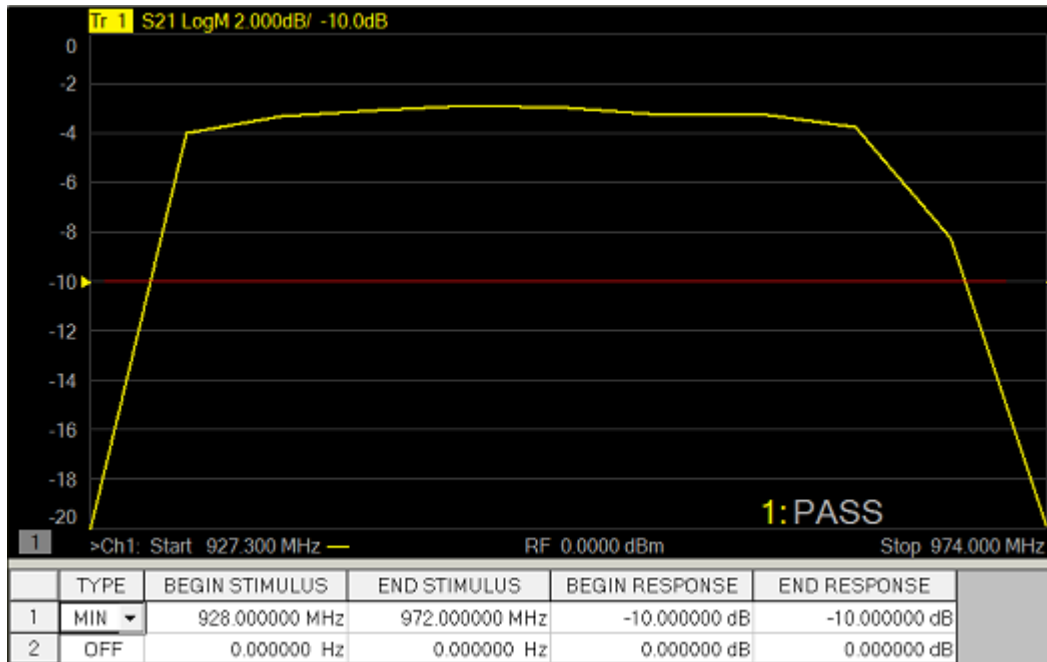

The following image shows the exact same conditions, except the number of data points is increased to 1601. The filter now fails the minimum limit test indicated by the red data trace.

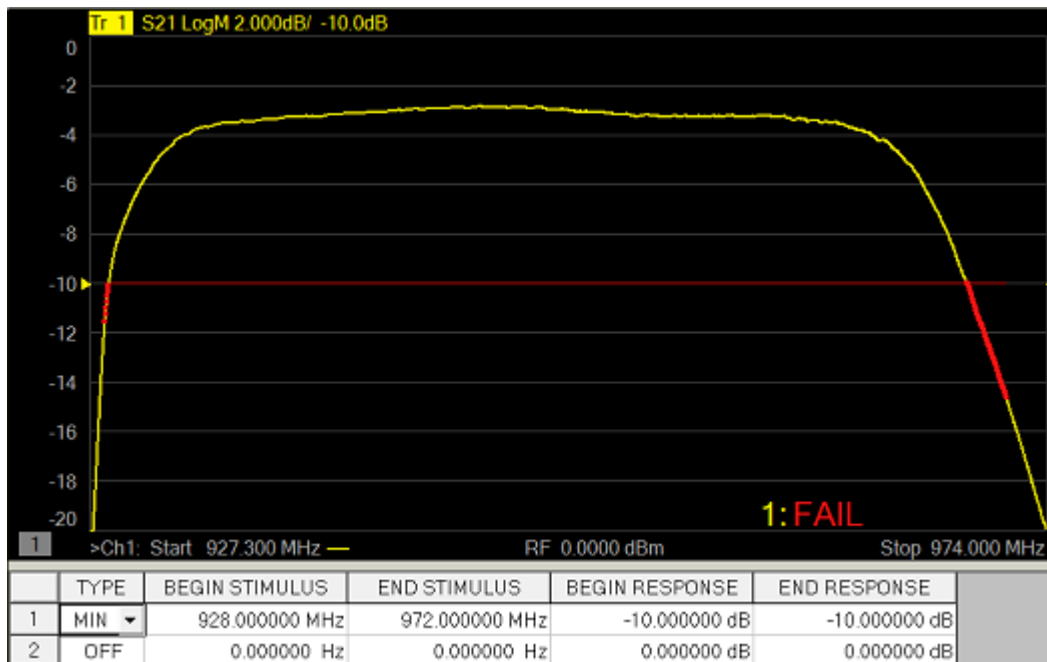

When **System > System Setting > Preference, Limit: Test nearest measurement point** is checked, the limit is compared with the nearest measurement point.

Limit Test at certain point

The limit test at a certain frequency point is available. This function is the similar with one in the E5071C. When (Begin Stimulus = End Stimulus) and (Begin Response = End Response) in the limit test table, the point is defined as point limit test and v (for max) or ^ (for min) symbol is displayed.

E5080A

When you use the point limit test, confirm if **System** > **System Setting** > **Preference, Limit: Test nearest measurement point** is checked. In this setting, even if the test point (= Begin Stimulus = End Stimulus) is not located at measurement point, the result is determined using the nearest measurement point.

Last Modified:

29-Sep-2015 First Release



5. Output Data

Save and Recall a File

The VNA allows you to save and recall files to and from an internal or external storage device in a variety of file formats.

- [Save VNA Instrument State and Calibration Files](#)
- [Save VNA Measurement Data](#)
- [Recall a File](#)
- [Instrument State and Calibration Files](#) (.csa, .cst, .sta, .cal)
- [Measurement Data Files](#) (.prn, .snp, .cti, .csv, .mdf)
- [Define Data Saves](#)
- [Managing Files without a Mouse](#)

Other Data Outputting topics

Save VNA Instrument State and Calibration Files

How to Save Instrument State and Calibration Files

Using **Hardkey/SoftTab/Softkey**

1. Press **Save Recall** > **Save State** or **Save Other**.

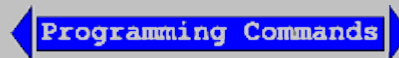

Save Recall > **Save State** Softtab Help

[Learn all about VNA Instrument State files.](#)

Save State - Immediately saves the VNA state, possibly calibration data and link to the selected filename by depends on the [Save Type](#). The selected filename is automatically generate in the storage when you performed a save.

Auto Save - Saves state, calibration data and link to the storage. Saves state and calibration data to the internal storage in the D: folder. A filename is generated automatically using the syntax "**atxxx**"; where xxx is a number that is increment by one when a new file is Auto Saved. The filename is depends on the [Save Type](#) to save it in ".sta", ".csa" or ".cst".

Save State As... - Starts the [Save As](#) dialog box.

Save Register - Immediately saves the specified register (Register 1 to 8) to the selected filename by depends on the [Save Type](#). The selected filename is automatically generate in the storage when you performed a save on selected register.

Save Type

State - Save VNA state in .sta filename.

State + Cal Data - Save VNA state and calibration data in .csa filename.

State + Cal Link - Save VNA state and calibration link in .cst filename.

Save Recall > Save Other Softtab Help

Save Calset... & Save Screen... - Starts the [Save As](#) dialog box.

Save Data... - Starts the [Save Data As](#) dialog box.

Save User Preset... - Start the [User Preset](#) dialog box.

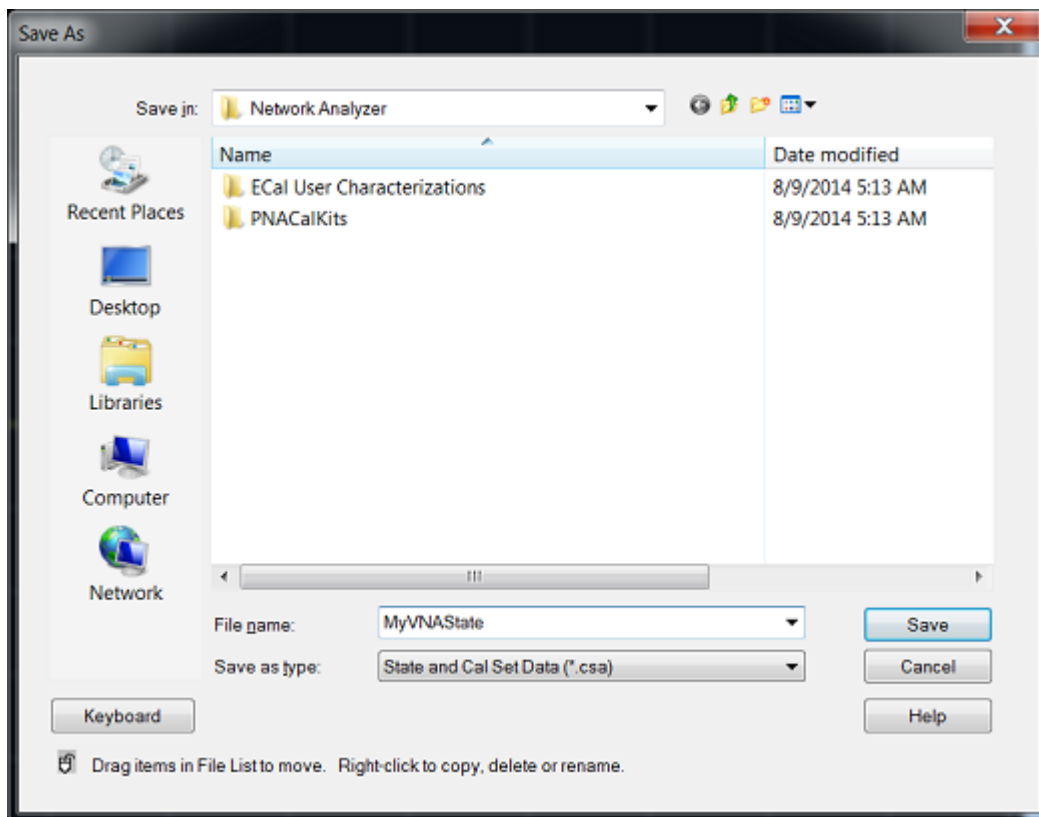

Save (State and Calibration) As Dialog Box Help

Save in - Allows you to navigate to the directory where you want to save the file.

File name - Displays the filename that you either typed in or clicked on in the directory contents box.

Note: Filenames (not including the path name) can be unlimited characters.

Save as type

The following file types save **Instrument states and Calibration data**. You can save and later recall, instrument settings and calibration data for **all channels** currently in use on the VNA. These file types are only recognized by Keysight VNA Series analyzers.

[Learn more about these file types.](#)

- ***.csa** - save Instrument state and actual Cal Set data (cal/state archive) **Default selection**
- ***.cst** - save Instrument state and a link to the Cal Set data
- ***.sta** - save Instrument state ONLY (**no** calibration data)
- ***.cal** - save actual Calibration data ONLY (**no** Instrument state)

Note: To save the VNA screen as .bmp, .jpg, or .png graphics file types, click **File/Print to File**. [Learn more.](#)

Save - Saves the file to the specified file name and directory.

Save VNA Measurement Data

How to Save VNA Measurement Data

Using **Hardkey/SoftTab/Softkey**

1. Press **Save Recall** > **Save Other**.
2. Click **Save Data...** and then **Save Data As** dialog box appears.

Save Data As - Saves the current trace(s) to the specified type of file.

Note: This dialog now contains the settings previously selected from the old [Define Data Save](#) dialog.

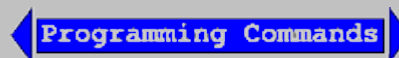

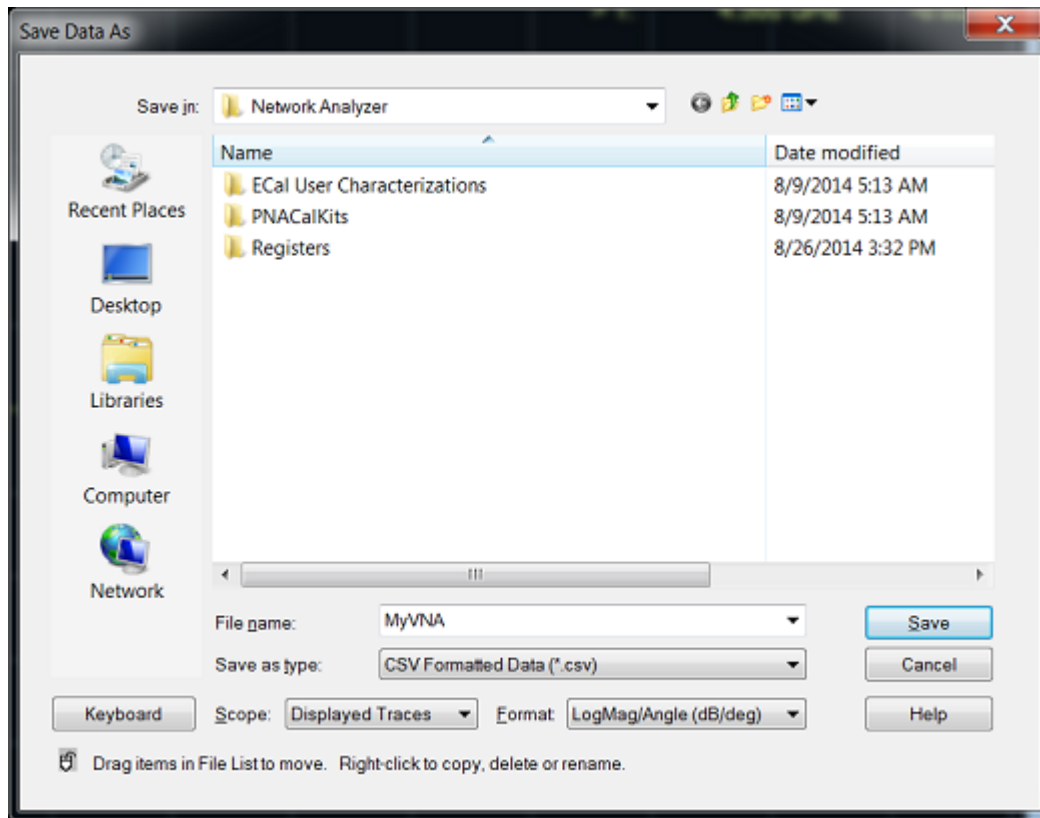

Save Data As Dialog Box Help

Note: Before saving measurement data, always [trigger a single](#) measurement, and then allow the VNA channel to go into Hold. This ensures that the entire measurement trace is saved.

Note: [Memory traces](#) can NOT be saved to any file type (PRN, SNP, CTI, CSV, MDF).

Save in - Allows you to navigate to the directory where you want to save the file.

File name - Displays the filename that you either typed in or clicked on in the directory contents box.

Note: Filenames (not including the path name) can be unlimited characters.

Save as type - Choose from: (click each to learn more about each file type) [*.prn](#), [*.SNP](#), [*.cti \(citifile\)](#), [*.csv](#), [*.mdf](#).

- **Trace and Noise Parameters (*.snp)** - Save the noise figure parameters and S-parameters. [Learn more.](#)

Scope

Determines what traces are saved to a file. Available ONLY with *.cti, *.csv, and *.mdf.

- **Auto**
 - When correction is OFF, saves the specified trace.
 - When correction is ON, saves all corrected parameters associated with the calibrated ports in the Cal Set.
- **Single Trace** - Saves the active trace.
- **Displayed Traces** - Saves all displayed traces for all channels.
- **Channel Traces** - Saves all displayed traces for active channels.

Format

Determines the format of the data. Available with (Citifile Formatted Data (*.cti), CSV Formatted Data (*.csv), SNP, MDIF Data (*.mdf))

- **Auto** - Data is saved in **LogMag/Angle** or **LinMag/Angle** if one of these is the currently selected display format. If format is other than these, then data is saved in **Real/Imaginary**.
- **LogMag/Angle (dB/deg), LinMag/Angle (unit/deg), Real/Imaginary** - Select output format.
- The imaginary portion for all **LogMag** and **LinMag** data is saved in degrees (dB/deg).
- **Real/Imaginary** data is never smoothed.
- **Displayed Format** (CSV and MDIF only) - Data is saved in the format of the displayed trace.

Note: .prn files can only save the active trace in the displayed format.

Save - Saves the file to the specified file name and directory.

Cancel - Closes the dialog.

Help - Displays **Save Data As** dialog box help.

Recall a file**How to Recall (open) a file**

Using **Hardkey/SoftTab/Softkey**

1. Press **Recall** > **Recall**.

Programming Commands

Save Recall > **Recall** Softtab Help

Recall State - Recall the specified filename.

Recall State - Select from a list of files shown on softkeys. The list can be sorted by 'most recently used' or alphabetically depending on a preference. The preference setting appears at the bottom of the second page of softkeys listing files to be recalled or on the Preference dialog.

Recall State... - Starts the [Recall](#) dialog box.

Recall Register - Recall the register (Register 1 to 8) which is saved in the D:\ drive (Only the saved register will enable to recall).

Recall Calset... - Starts the [Recall](#) dialog box.

Recall Data... - Starts the [Recall](#) dialog box.

Recall Order - A list of files for recall can arrange according to NAME or RECENT files.

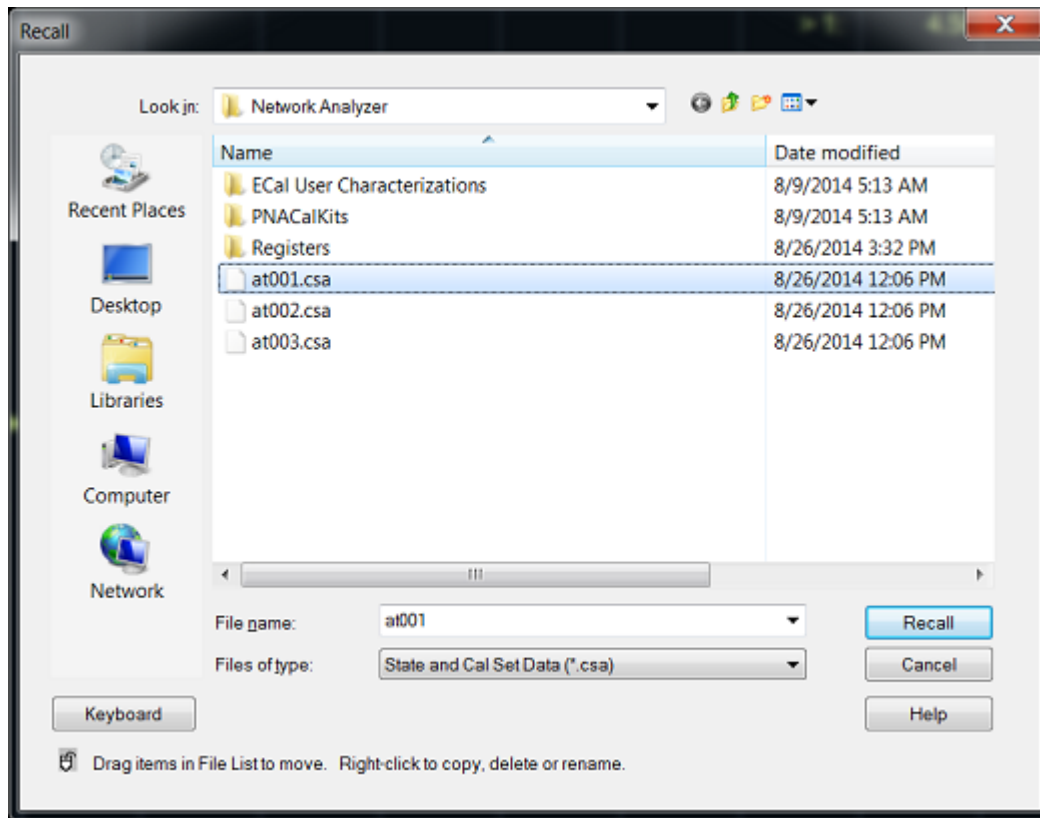

Recall Dialog Box Help

Look in - Allows you to select the directory that contains the file that you want to recall.

Filename - Displays the filename that you either typed in or clicked on in the directory contents box.

Files of type - Allows you view and select files that are listed in categories of a file type. The following types of files can be recalled into the VNA: All [State files](#), Citi files, SNP files.

Recalling VNA State files

When an Instrument State file is recalled into the VNA, the current state of the instrument is overwritten with the recalled state. A *.cal file does not contain an instrument state, but only calibration data. [Learn more about Instrument States](#).

See also [Power ON and OFF during Save/Recall, User Preset, and Preset](#).

Recalling Data files into the VNA

Citi files and SNP files can be recalled and viewed in the VNA.

1. Click **File** then **Recall**.
2. Select **Citifile Data** or **Snp**.
3. Select the file to recall.
4. Click **Recall**.

Note: Citi files that were saved in [CW Time sweep](#) can NOT be recalled into the VNA

Note: Filenames (not including the path name) that are longer than 64 characters will NOT be recalled.

Recalled data is ALWAYS displayed on the VNA using [LogMag format](#), regardless of how the file was stored.

The channel is placed in Trigger Hold. If triggering is resumed, the data will be overwritten.

SNP files are recalled as traces into a single window and channel, beginning at the [highest available channel number allowed on the VNA](#). For multi-port SNP files (greater than 4 ports), if the number of S parameters in the file is beyond the [maximum number of traces in a window](#), then new windows will be created.

Citi files are recalled into the same window and channel configuration as when they were saved. However, the new recalled channel numbers begin with the [highest channel number allowed on the VNA](#) and decrement for each additional channel.

For example, when a citi file is saved, two traces are in window 1, channel 1 and two additional traces are in window 2, channel 2. When recalled into a factory preset condition (1 trace in window 1, channel 1), the first two recalled traces appear in window 2, highest channel number, and the second two traces appear in window 3, (highest channel number -1). See also [Traces, Channels, and Windows on the VNA](#)

Recall - Recalls the file displayed in the file name box.

Instrument State / Calibration Files

You can save, and later recall, instrument settings and calibration data **for all channels** currently in use on the VNA.

An **Instrument State** contains almost every VNA setting. The following VNA settings are NOT saved and recalled with Instrument State:

- [GPIB address](#)
- [RF power ON/OFF](#) (depends on current setting)
- Test set I/O settings

The following file types are used to save and recall instrument states and Cal Set information:

File Types		Information that is stored for each channel			
.csa	.cst		.sta	Instrument State Information	
				Channels/Traces	Averaging
				Windows	Markers
				Triggering	Math/memory
				Format	Limits
				Scale	More...
				Stimulus Information:	
				Frequency range	Alternate sweep
				Number of points	Port powers
				IF bandwidth	Source attenuators
				Sweep type	Receiver attenuators
				Sweep mode	Test Set port map
			.cal	Cal Set Information	
				GUID (Globally Unique Identifier) provides link to Cal Set	
				Name, Description, Modify date	
				Stimulus Information:	
				Frequency range	Alternate sweep

		Number of points Port powers IF bandwidth Source attenuators Sweep type Receiver attenuators Sweep mode Test Set port map Error Terms: Directivity, Crosstalk, Source match, Load match, Reflection tracking, Transmission tracking
--	--	--

File Type Descriptions and Recall

The following describes each file type and what occurs when the file type is recalled.

*.sta files

- Contain ONLY instrument state information - NOT Cal data.
- When recalled, they always replace the current instrument state immediately.

*.cst files

- Contain BOTH instrument state and a LINK to the Cal Sets. [Learn more about Cal Sets.](#)
- The **quickest and most flexible** method of saving and recalling a calibrated instrument state.
- Channels need not have cal data to save as .cst file.
- When recalled, the state information is loaded first. Then the VNA tries to [apply a Cal Set](#) as you would do manually. If the stimulus settings are different between the instrument state and the linked Cal Set, the usual choice is presented ([see Cal Sets](#)). If the linked Cal Set has been deleted, a message is displayed, but the state information remains in place.
- Because only a link to the Cal Set is saved, the Cal Set can be shared with other measurements.

Note: Before saving a .cst file, be sure that a User Cal Set (NOT a Cal Register) is being used for the calibration. Cal Registers are overwritten with new data whenever a calibration is performed, and may not be accurate cal data when the .cst file is recalled. [Learn more about Cal Sets.](#)

*.cal files

- Contain ONLY Cal Set information.
- When recalled, the Cal Set is NOT automatically applied. Apply the calibration data to a channel as you would [apply any Cal Set](#).
- [Learn about Recalling](#)

*.csa files

- Contain ALL instrument state and the actual Cal Set; not a link to the Cal Set.
- The **safest** method of saving and recalling a calibrated instrument state. However, the file size is larger than a *.cst file, and the save and recall times are longer. In addition, because the actual Cal Set is saved, it is very difficult to share the cal data with other measurements.
- Channels need not be calibrated to save as .cst file.
- The Cal Set that is saved could be a [Cal Register or a User Cal Set](#).
- [Learn about Recalling](#)

Note: *.pcs files are the internal file format the VNA uses for storing cal sets. These files should never be accessed or copied by the user.

Measurement Data Files

Measurement data is saved as ASCII file types for use in a spreadsheet or CAE programs.

Note: Before saving measurement data, always [trigger a single](#) measurement, and then allow the VNA channel to go into Hold. This ensures that the entire measurement trace is saved.

Note: [Memory traces](#) can NOT be saved to any file type (PRN, SNP, CTI, CSV, MDF).

The following file types can be saved by the VNA.

- [*.prn files](#)
- [*.snp \(Touchstone\)](#)
- [*.cti \(Citifile\)](#)
- [*.csv](#)
- [*.mdf \(MDIF\)](#)

*.prn Files

.Prn files have the following attributes:

- Comma-separated data which can be read into rows and columns by spreadsheet software, such as Microsoft Excel. To avoid the "delimiting" dialog boxes, change the filename extension from .prn to .csv. Then, open directly into Microsoft Excel.
- Contain formatted and corrected stimulus and response data for the current active trace ONLY.
- Are Output only - they cannot be read by the VNA.
- [Cal Set Viewer](#) data can be saved to *.prn files

How to Save PRN Trace Data (*.prn)

Using **Hardkey/SoftTab/Softkey**

1. Press **Save Recall** > **Save Other**.
2. Click **Save Data...** and then **Save Data As** dialog box appears.
3. Under **Save as type**, select **PRN Trace Data (*.prn)**.

Programming Commands

Example:

```
"S11 Log Mag"
"Freq (Hz)","dB",
100000, 9.906526e-002,
45099500, -2.173586e-002,
90099000, -3.312639e-002,
135098500, -2.832297e-003,
180098000, 1.833988e-002,
225097500, -1.936939e-002,
270097000, -1.058220e-002,
315096500, -7.141036e-003,
360096000, -8.091703e-003,
```

.SNP Format (*.s1p, *.s2p, *.s3p, *.s4p)

- *.SNP file format, also known as Touchstone format, is specified by IBIS. [See the Touchstone specification](#).
- *.SNP file format is used by CAE programs such as Keysight's Microwave Design System (MDS) and Advanced Design System (ADS).
- *.SNP data is saved using the **File**, [Save Data As](#) dialog.

Before saving measurement data, always [trigger a single](#) measurement, and then allow the VNA channel to go into Hold. This ensures that the entire measurement trace is saved.

*.SNP files and other VNA settings

- .SNP data can be [recalled](#) and viewed on the VNA, or read by the VNA [embed/de-embed](#) functions.
- To save SNP data with an external test set enabled, at the File, [Save As](#) dialog, select **SNP File(*.s*p)**, then complete the ["Choose Ports " dialog](#).
- When [Fixturing](#) is enabled, all of the enabled data transforms (De-embedding, Port Z Conversion, and so forth) are applied to saved SNP files.
- When [Smoothing](#) is applied to a trace, the smoothing is NOT saved when the format is Real, Imaginary (RI). Select a different format to save the smoothed data.
- Noise Figure parameters and S-parameters can be saved to an *.s2p file. [Learn more](#).
- Balanced parameters can be saved to *.SNP files. See the ["Choose Ports " dialog](#).
- **IMPORTANT** - ALL valid data is saved using the same format and settings (trace math, offset, delay, and so forth) as the active measurement. This can cause the data that is saved for the non-active measurements to be dramatically different from the data that is displayed. For example, when saving an S2P file, if the active S11 measurement is set to Data/Mem (data divided by memory), then ALL 4 S-parameters are saved using Data/Mem. The memory trace that is used in the Data/Mem operation is the same as that used in the active (S11) measurement.

What is Saved

*.SNP data is generally used to gather all S-parameters for a fully corrected measurement. The VNA saves the data that is available on the channel of the active measurement.

File Type	# of Ports	# of S-parameters saved
*.s1p	1	1 S-parameter
*.s2p	2	4 S-parameters
*.s3p	3	9 S-parameters
*.s4p	4	16 S-parameters
...
*.SNP	N	N² S-parameters

- If correction for a **Full N-port cal** is applied, then valid data is returned for all corrected S-parameters. Response calcs will save uncorrected data.
- If requesting **less** data then is available, the [Choose ports for SNP data](#) dialog appears.

- If correction is NOT applied, the VNA returns as much applicable raw data as possible using S-parameter measurements on the selected channel. Data that is not available is zero-filled. For example, if correction is NOT applied and the active measurement is S11, and an S21 measurement also exists on the channel, then data is returned for the S11 and S21 measurements. Data for S12 and S22 is not available and therefore returned as zeros in Real/Imaginary format. In Log Mag/Phase format, this appears as -200 dB and 45 degrees.

How to Save .SNP Format (*.s1p, *.s2p, *.s3p, *.s4p)

Using **Hardkey/SoftTab/Softkey**

1. Press **Save Recall** > **Save Other**.
2. Click **Save Data...** and then **Save Data As** dialog box appears.
3. Under **Save as type**, select **Trace (*.s1p, *.s2p, *.s3p or *.s4p)**.

Programming Commands

.SNP Data Output

*.SNP files contain: header information and the following **Comma-Separated Values**. The only difference between .s1p, s2p, and so forth, is the number of S-parameters that are saved.

- Stimulus data
- Data pairs for EACH S-parameter measurement

Note: Although the following shows Real/Imaginary pairs, the format could also be LogMag/Phase or LinMag/Phase

*.s1p File

Each record contains 1 stimulus value and 1 S-parameter (total of 3 values)

Stim Real (Sxx) Imag(Sxx)

Example:

```
!Keysight Technologies,E5080A,MY55100056,A.10.99.02
!Date: Tuesday, November 25, 2014 13:15:03
!Correction: S11(Off)
!S1P File: Measurement: S11:
# Hz S dB R 50
100000 0.10494874 -0.30662519
45099500 -0.039064661 -0.64403939
90099000 -0.038124748 -1.0683264
135098500 -0.0094892867 -1.5759366
180098000 0.014229189 -2.3191988
225097500 -0.020684797 -2.8619499
270097000 -0.014656636 -3.4809942
```

***.s2p File**

Each record contains 1 stimulus value and 4 S-parameters (total of 9 values)

Stim Real (S11) Imag(S11) Real(S21) Imag(S21) Real(S12)
Imag(S12) Real(S22) Imag(S22)

Example:

```
!Keysight Technologies,E5080A,MY55100056,A.10.99.02
!Date: Tuesday, November 25, 2014 13:23:10
!Correction: S11(Off)
!S21(Off)
!S12(Off)
!S22(Off)
!S2P File: Measurements: S11, S21, S12, S22:
# Hz S dB R 50
100000 -200 45 -53.193119 44.821617 -200 45 -200 45
45099500 -200 45 -85.316757 83.057785 -200 45 -200 45
90099000 -200 45 -86.266129 117.26331 -200 45 -200 45
135098500 -200 45 -97.65741 -75.884865 -200 45 -200 45
180098000 -200 45 -83.678986 -38.655216 -200 45 -200 45
225097500 -200 45 -100.30289 110.7329 -200 45 -200 45
270097000 -200 45 -90.416489 -95.377228 -200 45 -200 45
```

***.s3p File**

Each record contains 1 stimulus value and 9 S-parameters (total of 19 values)

Stim Real (S11) Imag(S11) Real(S12) Imag(S12) Real(S13)
Imag(S13)
Real (S21) Imag(S21) Real(S22) Imag(S22) Real(S23)
Imag(S23)
Real (S31) Imag(S31) Real(S32) Imag(S32) Real(S33)
Imag(S33)

Example:

```
!Keysight Technologies,E5080A,MY55100056,A.10.99.02
!Date: Tuesday, November 25, 2014 13:46:11
!Correction: S11(Off)
!S12(Off)
!S13(Off)
!S21(Off)
!S22(Off)
!S23(Off)
!S31(Off)
!S32(Off)
!S33(Off)
!S3P File: Measurements: <S11,S12,S13>,
!<S21,S22,S23>,
!<S31,S32,S33>:
# Hz S dB R 50
100000 -200 45 -200 45 -200 45
-53.0299 39.06152 -200 45 -200 45
-200 45 -200 45 -200 45
45099500 -200 45 -200 45 -200 45
-86.416527 -148.5036 -200 45 -200 45
-200 45 -200 45 -200 45
```

***.s4p File**

Each record contains 1 stimulus value and 16 S-parameters (total of 33 values)

```
Stim Real(S11) Imag(S11) Real(S12) Imag(S12) Real(S13)
Imag(S13) Real(S14) Imag(S14)
Real(S21) Imag(S21) Real(S22) Imag(S22) Real(S23)
Imag(S23) Real(S24) Imag(S24)
Real(S31) Imag(S31) Real(S32) Imag(S32) Real(S33)
Imag(S33) Real(S34) Imag(S34)
Real(S41) Imag(S41) Real(S42) Imag(S42) Real(S43)
Imag(S43) Real(S44) Imag(S44)
```

Example:

```
!Keysight Technologies,E5080A,MY55100056,A.10.99.02
!Date: Tuesday, November 25, 2014 13:49:39
!Correction: S11(off)
!S12(off)
!S13(off)
!S14(off)
!S21(off)
!S22(off)
!S23(off)
!S24(off)
!S31(off)
!S32(off)
!S33(off)
!S34(off)
!S41(off)
!S42(off)
!S43(off)
!S44(off)
!S4P File: Measurements: <S11,S12,S13,S14>,
!<S21,S22,S23,S24>,
!<S31,S32,S33,S34>,
!<S41,S42,S43,S44>:
# Hz S dB R 50
100000 -200 45 -200 45 -200 45 -200 45
-53.203884 42.648342 -200 45 -200 45 -200 45
-200 45 -200 45 -200 45 -200 45
-200 45 -200 45 -200 45 -200 45
```

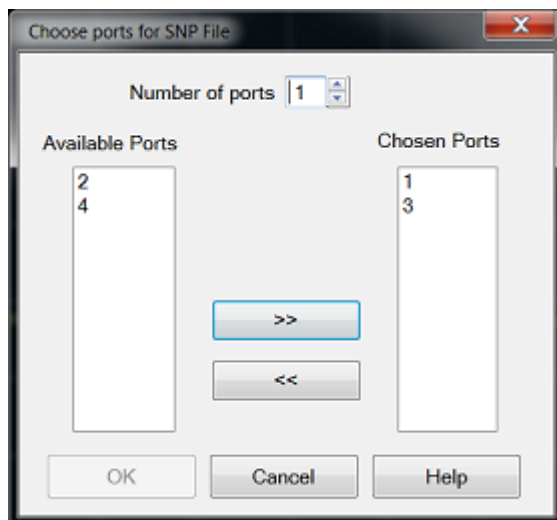
**Choose ports for SNP File Dialog Box Help**

This dialog allows you to choose which S-parameter data to save when selecting File, [Save As](#), Trace SNP and any of the following conditions exist:

- you request less data than is available.

- you want data for more than 4 ports.
- a balanced measurement is active.

Number of ports - Select the number of ports for which data will be saved.

Arrow buttons - Click (>>) to Add and click (<<) to Remove ports for the following columns:

Available Ports - The VNA/External test set ports. There may NOT be valid data available for all of these ports. [Learn more.](#)

Chosen Ports - When **OK** is clicked, SNP data is saved for these ports.

OK - Becomes available when the number of **Chosen ports** = the **Number of ports** to save. Click to save to SNP file.

With **Number of ports** = 2, .s2p data is saved; with **Number of ports** = 3, .s3p data is saved, and so forth. [Learn more about SNP files](#)

.cti (Citi) Files

Citiformat is compatible with the Keysight 8510 Network Analyzer and Keysight's Microwave Design System (MDS).

You can do the following using citiformats :

- Save the active trace or all traces.
- Save formatted or unformatted citiformat data.

How to Save Citiformatted Data (*.cti)

Using Hardkey/SoftTab/Softkey

1. Press **Save Recall** > **Save Other**.
2. Click **Save Data...** and then **Save Data As** dialog box appears.
3. Under **Save as type**, select **Citiformatted Data (*.cti)**.

Programming Commands

*.csv files contain:

- Header information
- Stimulus data
- Data pairs for EACH S-parameter measurement

```
CITIFILE A.01.01
!Keysight Technologies ,E5080A,MY55100056,A.10.99.02
!Format: LogMag/Angle
!Date: Tuesday, November 25, 2014 13:55:21
NAME CH1_DATA
VAR Freq MAG 201
DATA S[1,1] DBANGLE
VAR_LIST_BEGIN
100000
45099500
90099000
135098500
180098000
225097500
270097000
```

Format is identified by **DBANGLE** (log mag), **MAGANGLE** (Lin Mag), or RI (real, imaginary - NOT shown)

On the data access map, Formatted data is taken from location 2 or 4.

How to Save Citifile Unformatted Data (*.cti)

Using **Hardkey/SoftTab/Softkey**

1. Press **Save Recall** > **Save Other**.
2. Click **Save Data...** and then **Save Data As** dialog box appears.
3. Under **Save as type**, select **Citifile Data Data (Real,imag) (*.cti)**.

Programming Commands

On the data access map, Unformatted data is taken from the block just before Format.

Citifiles can be recalled and viewed in the VNA. [Learn more.](#)

***.csv Files**

Note: 2D Gain Compression data is saved as *.csv files using a different format than shown here. [Learn more.](#)

CSV files are read by spreadsheet programs such as Microsoft Excel.

How to Save CSV Formatted Data (*.csv)

Using **Hardkey/SoftTab/Softkey**

1. Press **Save Recall** > **Save Other**.
2. Click **Save Data...** and then **Save Data As** dialog box appears.
3. Under **Save as type**, select **CSV Formatted Data (.csv)**.

Programming Commands

*.csv files contain:

- Header information and the following Comma-Separated Values.
- Stimulus data
- Data pairs for EACH S-parameter measurement

```
!CSV A.01.01
!Keysight Technologies,E5080A,MY55100056,A.10.99.02
!Date: Tuesday, November 25, 2014 13:59:46
!Source: Standard
```

```
BEGIN CHI_DATA
Freq(Hz),S12(DB),S12(DEG)
100000,-52.485683,48.510338
45099500,-88.645714,8.0142174
90099000,-91.439514,151.57732
135098500,-97.596909,161.57434
180098000,-89.367058,-8.4136505
225097500,-90.176117,-28.1868
270097000,-92.614517,39.603615
```

*.mdf Files

MDIF files are compatible with Keysight ADS (Advanced Design System).

How to Save MDIF Data (*.mdif)

Using **Hardkey/SoftTab/Softkey**

1. Press **Save Recall** > **Save Other**.
2. Click **Save Data...** and then **Save Data As** dialog box appears.
3. Under **Save as type**, select **MDIF Data (*.mdif)**.

Programming Commands

*.mdf files contain:

- Header information and Space-Separated Data.
- Stimulus data
- Real and Imaginary data pair for EACH S-parameter measurement

```
!MDF A.01.01
!Keysight Technologies,E5080A,MY55100056,A.10.99.02
!Date: Tuesday, November 25, 2014 14:03:06
```

```
BEGIN CHI_DATA
% Freq(real) S1_2(complex)
100000 0.0019314616 0.0013986562
45099500 3.1364398e-005 -4.5943485e-005j
90099000 -1.8545568e-005 4.4789402e-005
135098500 1.3526749e-005 -1.0504767e-005
180098000 -3.9172905e-005 -4.4675748e-005
225097500 -2.7127206e-005 -1.5924486e-005
```

Define Data Saves

Note: Although these settings are still supported, they are no longer necessary to save data files. The [Save Data As](#) dialog box contains these settings.

How to select Define Data Saves

Using **Hardkey/SoftTab/Softkey**

1. Press **System** > **System Settings** > **Preferences....**
2. Select **Data Saves...** on the Preferences dialog box.

Programming Commands

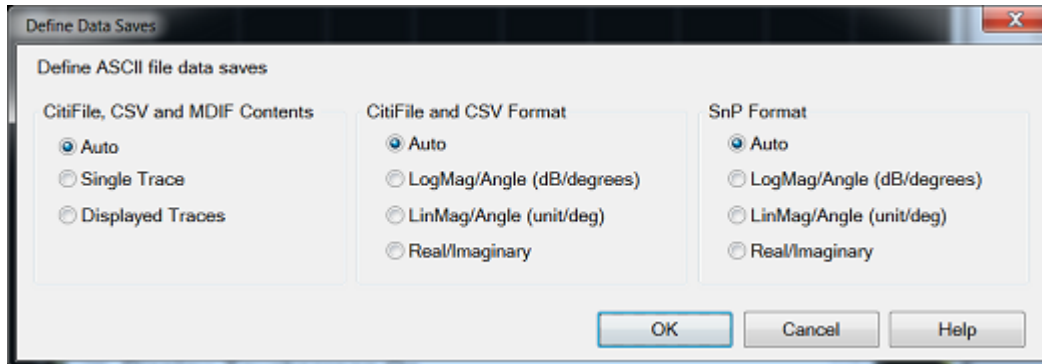

Define Data Saves Dialog Box Help

Note: Although these settings are still supported, they are no longer necessary to save data files. The [Save Data As](#) dialog box contains these settings.

The following settings survive an Instrument Preset and VNA Shutdown.

CitiFile, CSV, and MDIF Contents

Determines what is saved to a .cti file.

Auto - Saves the active trace. Additional traces are saved if correction is ON. For Full 2-port calibration, 4 traces are saved; for Full 3-port calibration, 9 traces are saved, and so forth.

Single Trace - Saves the active trace.

Displayed Traces - Saves all displayed traces for all channels.

Citifile and CSV Format

Auto - Data is saved in LogMag or LinMag if one of these is the currently selected display format. If format is other than these, then data is saved in Real/Imag.

LogMag/Angle (dB/degrees), LinMag/Angle (unit/deg), Real/Imaginary - Select output format.

- The imaginary portion for all LogMag and LinMag data is saved in degrees.
- Real/Imaginary data is never smoothed.

SnP Format (.s1p, .s2p, .s3p, .s4p)

[Learn more about SnP files.](#)

Auto - Data is saved in LogMag or LinMag if one of these is the currently selected format. If format is other than these, then data is saved in Real/Imag.

LogMag, LinMag, Real/Imag - Select output format. The imaginary portion for all LogMag and LinMag data is output is in degrees.

Manage Files without a Mouse

How to Manage Files without a Mouse

Using Hardkey/SoftTab/Softkey

1. Press **Save Recall** > **Save Other**.
2. Click **Manage Files...** and then **D:\ drive folder** dialog box appears.

OR

1. Press **System** > **Main**.
2. Click **Manage Files...** and then **D:\ drive folder** dialog box appears.

No programming commands are available for this feature

The Manage Files dialog box is designed to be used from the front panel. It performs the same function as Windows Explorer, but can be used without the use of a mouse or keyboard.

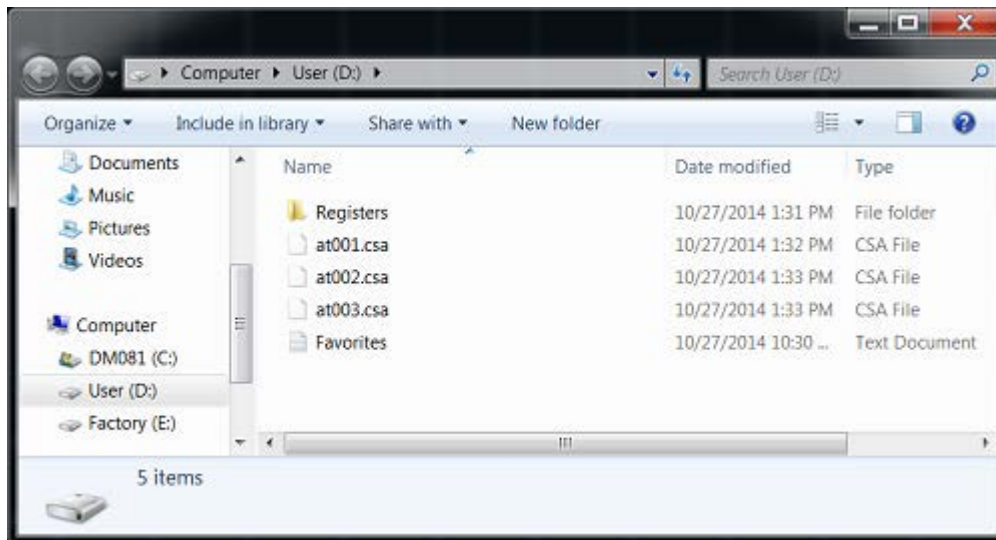

Last modified:

29-Sep-2015 First Release



Print a Displayed Measurement

The analyzer allows you to print a displayed measurement to a printer or to a file. The printer can be either networked or local.

- [Connect a Printer](#)
- [Printing](#)
 - [Print a Hardcopy](#)
 - [Page Setup](#)
 - [Print to a File](#)

Other Outputting Data topics

Connect a Printer

You can connect a printer to one of the VNA USB ports or to the LAN connector.

To Add a Printer

Note: If you try to print from the VNA application and the **Add Printer Wizard** appears, click **Cancel** and add the printer using the following procedure.

1. From the VNA application, press **System** > **Main** > **Minimize Application**.
2. On the Windows taskbar, click **Devices and Printers**.
3. Double-click **Add a printer**.
4. Follow the instructions in the **Add Printer Wizard**.

For more information, refer to Microsoft Windows Help or your printer documentation.

Printing

The measurement information on the screen can be printed to any local or networked printer that is connected to the VNA. The graphic below shows an example of how a screen-capture image appears when printed. The [Page Setup](#) settings allows you to customize the printed form of the measurement information.

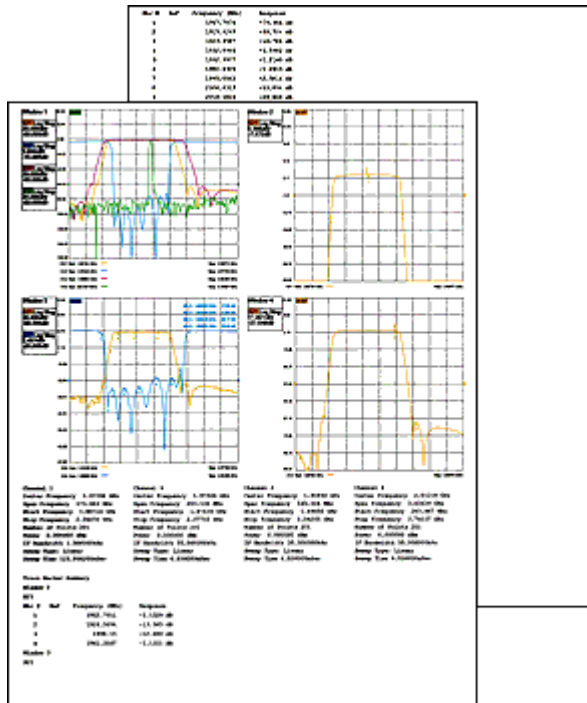

Print a Hardcopy

How to Print a Hardcopy

Using Hardkey/SoftTab/Softkey

1. Press **System** > **Print**.
2. Click **Print...**

No programming commands are available for this feature.

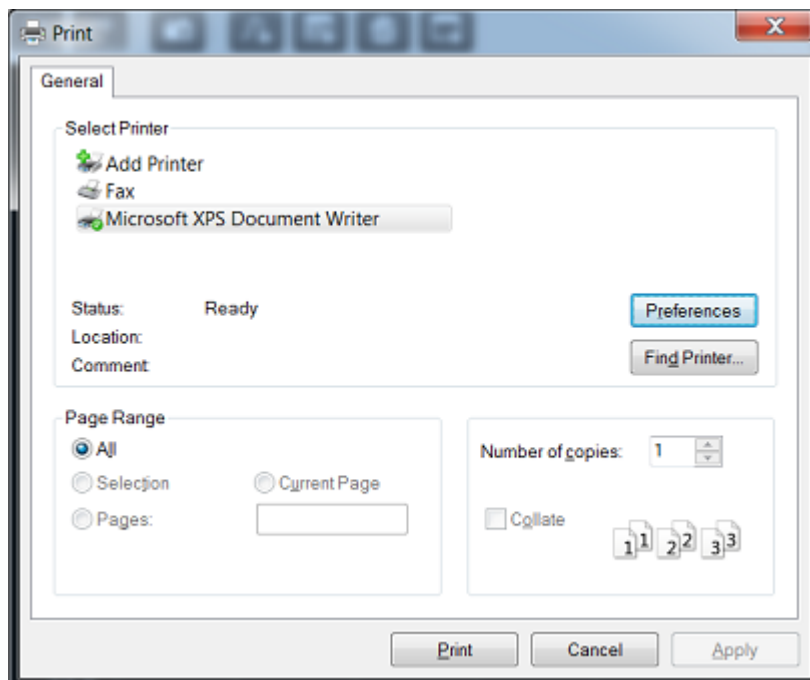

Note: For information on the choices in the Print dialog box, see Windows Help.

Page Setup

The Page Setup dialog allows flexibility in the appearance that measurement data is printed.

How to select Page Setup

Using **Hardkey/SoftTab/Softkey**

1. Press **System** > **Print** > **Page Setup...**

OR

1. Press **System** > **System Settings** > **Preferences...**
2. Click **Page Setup...** on Preferences dialog box.

◀ **Programming Commands** ▶

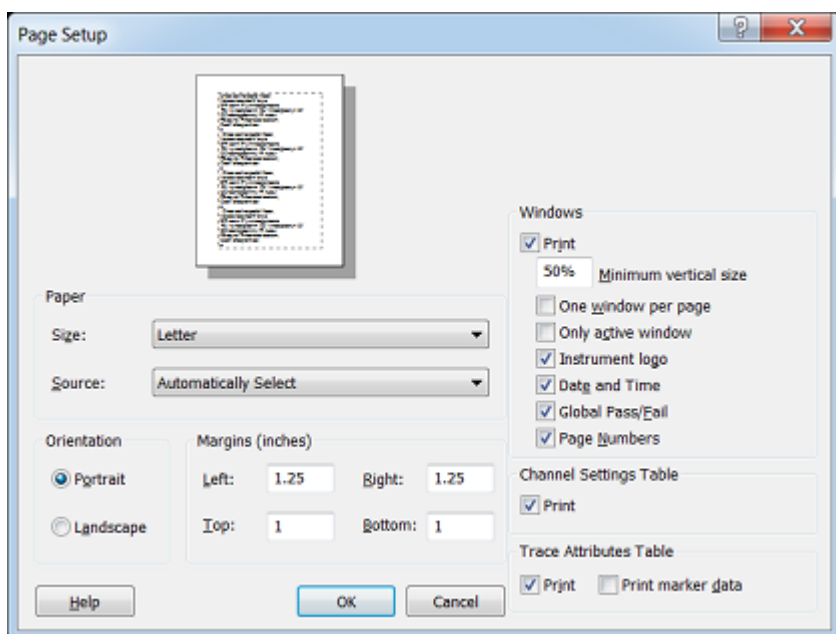

Page Setup Dialog Box Help

Paper, Orientation and Margins

These settings do NOT survive a VNA shutdown.

See Windows Help for information on these settings.

Windows

The following VNA specific settings DO survive a VNA shutdown:

Minimum vertical size - Adjust to change the amount of a page that the measurement window fills. The adjustment range is from 40 to 100%.

One window per page - Check to print one window per page. Clear to print all selected windows without a forced page break.

Only active window - Check to print only the active window. Clear to print all windows.

Instrument logo - Check to print the Keysight logo to the header.

Data and Time - Check to add the current date and time to the header.

Global Pass/Fail - Check to add the Global Pass/Fail status to the header.

Page Numbers - Check to add page numbers (1 of n) to the header.

Channel Settings Table

Print - Check to print the channel settings table.

Segment data can no longer be printed.

Trace Attributes Table

Print - Check to print the Trace Attributes Table. The Trace Attributes are measurement type, correction factors ON or OFF, smoothing, options, and marker details. The Trace Attributes are listed by Trace ID# for each window.

Each Trace ID# can have multiple entries depending on the number of markers associated with the trace. The marker details are marker number, position and response. If there are multiple markers on a trace, the trace attributes are only shown for the first marker. However, the trace attributes for the first marker apply to all other markers on that trace.

The options column can have one or more options. **D** for Delay, **M** for Marker, **G** for Gating. Multiple options selected would appear as follows: DMG.

Print marker data - Check to print all marker data. The amount of data depends on how many markers are created.

Print to a File

The analyzer can save a screen-capture image in any of the following formats:

- **.png** (Portable Network Graphics Format)
- **.bmp** (Bitmap File)
- **.jpg** (JPEG File Interchange Format)

The analyzer automatically saves the file to the current path. If not previously defined, the analyzer automatically selects the default path D:.

A .bmp file, like a .prn file, can be imported into software applications such as Microsoft Excel, Word or Paint to display a screen-capture image.

[See Save and Recall files for more information.](#)

How to Print to a File

Using **Hardkey/SoftTab/Softkey**

1. Press **System** > **Print** > **Print to File....**

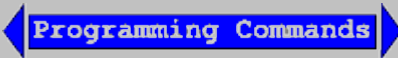

Last modified:

29-Sep-2015 First Release



Programming

Programming Guide

Two ways to find programming commands:

1. From a User Interface (Hardkey):

- Trace
- Channel
- Display
- Setup
- Meas
- Format
- Scale
- Math
- Avg BW
- Calibration
- Marker
- Search
- Save Recall
- Power
- Frequency
- Sweep
- Trigger
- System

	GPIB / SCPI
2.	<u>Command Tree</u>
See Also	Example Programs Learning about GPIB

See Also

- Shut Down or Restart the VNA Remotely
- [LXI and VXI Compliance](#)
- [Using Macros](#)
- Code Translator App.
- Data Access Map

SCPI

Commands

SCPI Command Tree

See Also

- Example Programs
- [See list of all SCPI Errors.](#)
- See Calibrating the VNA Using SCPI
- [Synchronizing the VNA and Controller](#)
- [IEEE- 488.2 Common Commands](#)
- Local Lockout

ABORt Stops all sweeps

+ CALCulate [Click to hide and show CALC / CALC:MEAS branches](#)

CORRection	Electrical Delay and Phase Offset
CONVersion	Parameter conversion function
DATA	Sends and queries data.
<u>Equation</u>	Equation Editor
FILTer	Time domain gating
FORMat	Display format
FSIMulator	Balanced measurements and Fixturing
FUNcTion	Trace Statistics
GDElay	Group Delay Aperture setting
LIMit	Limit lines for pass / fail testing
MARKer	Marker settings
MATH	Math / Memory
MIXer	X-axis display for FCA measurements
OFFSet	Mag and Phase offset
PARAmeter	Create and delete measurements
RDATa?	Queries receiver data
SMOothing	Point-to-point smoothing
TRANsform	Time domain transform
X:VALues	Returns X-Axis values for trace
CONTRol	Interface control, ECal module state control, and Rear-panel connector control.
CSET	Work with a Cal Set without having to select it into that channel.
DISPlay	Display settings
FORMat	Format for data transfer
HCOPy	Hardcopy printing

INITiate	Continuous or manual triggering
LXI	LXI communications
MMEMory	Saves and recalls instrument states
OUTPut	Turns RF power ON and OFF

+ SENSE [Click to hide and show SENSE branches](#)

AVErage	Sweep Averaging
BANDwidth	IF Bandwidth
CLASs	Returns measurement class name
CORRection	Calibration and other correction settings
COUPle	Chopped or Alternate sweep
FOM	Frequency Offset (opt 009)
FREQuency	Frequency sweep settings
MIXer	FCA measurements (opts 082 and 083)
MULTiplexer	Controls external test sets.
ROSCillator	Returns the source of the reference oscillator.
SEGment	Segment sweep settings.
SWEep	Sweep types
VOLTage	DC Voltage Range
X:VALues	X-axis values for channel

SOURce	Source power to the DUT
STATus	Reads the VNA status registers
SYSTem	Misc VNA capabilities
TRIGger	Trigger measurements



Last Modified:

29-Sep-2015 First Release

IEEE 488.2 Common Commands

[*CLS - Clear Status](#)

[*ESE - Event Status Enable](#)

[*ESE? - Event Status Enable Query](#)

[*ESR? - Event Status Enable Register](#)

[*IDN? - Identify](#)

[*OPC - Operation complete command](#)

[*OPC? - Operation complete query](#)

[*OPT? - Identify Options Query](#)

[*RST - Reset](#)

[*SRE - Service Request Enable](#)

[*SRE? - Service Request Enable Query](#)

[*STB? - Status Byte Query](#)

[*TST? - Result of Self-test Query](#)

[*WAI - Wait](#)

See Also

- Example Programs
- [Synchronizing the VNA and Controller](#)
- [SCPI Command Tree](#)

***CLS - Clear Status**

Clears the instrument status byte by emptying the error queue and clearing all event registers. Also cancels any preceding *OPC command or query. See [Status Commands](#) and [Reading the Analyzer's Status Registers](#).

***ESE - Event Status Enable**

Sets bits in the standard event status enable register. See [Status Commands](#) and [Reading the Analyzer's Status Registers](#).

***ESE? - Event Status Enable Query**

Returns the results of the standard event enable register. The register is cleared after reading it. See [Status Commands](#) and [Reading the Analyzer's Status Registers](#).

***ESR - Event Status Enable Register**

Reads and clears event status enable register. See [Status Commands](#) and [Reading the Analyzer's Status Registers](#).

***IDN? - Identify**

Returns a string that uniquely identifies the analyzer. The string is of the form "Keysight Technologies",<model number>,<serial "number">,<software revision>" .

***OPC - Operation complete command**

Generates the OPC message in the standard event status register when all pending overlapped operations have been completed (for example, a sweep, or a Default). See [Understanding Command Synchronization](#).

***OPC? - Operation complete query**

Returns an ASCII "+1" when all pending overlapped operations have been completed. See [Understanding Command Synchronization](#)

***OPT? - Identify Options Query**

Returns a string identifying the analyzer option configuration.

***RST - Reset**

Executes a device reset and cancels any pending *OPC command or query, exactly the same as a [SYSTem:PRESet](#) with one exception: Syst:Preset does NOT reset [Calc:FORMAT](#) to ASCII. The contents of the analyzer's non-volatile memory are not affected by this command.

***SRE - Service Request Enable**

Before reading a status register, bits must be enabled. This command enables bits in the service request register. The current setting is saved in non-volatile memory. See [Status Commands](#) and [Reading the Analyzer's Status Registers](#).

***SRE? - Service Request Enable Query**

Reads the current state of the service request enable register. The register is cleared after reading it. The return value can be decoded using the table in [Status Commands](#). See also [Reading the Analyzer's Status Registers](#).

***STB? - Status Byte Query**

Reads the value of the instrument status byte. The register is cleared only when the registers feeding it are cleared. See [Status Commands](#) and [Reading the Analyzer's Status Registers](#).

***TST? - Result of Self-test Query**

Returns the result of a query of the analyzer hardware status.

***WAI - Wait**

Prohibits the instrument from executing any new commands until all pending overlapped commands have been completed. See [Understanding Command Synchronization](#)

[About Triggering](#)**Abort Command**

ABORt**Applicable Models:** E5080A, M9485A

(Write-only) Stops all sweeps - then resume per current trigger settings. This command is the same as [INITtiate:IMMEDIATE](#) (restart) except if a channel is performing a single sweep, ABORt will stop the sweep, but not initiate another sweep.

Learn about [Synchronizing the VNA and Controller](#)**Examples**

```
ABOR  
abort
```

Query Syntax

Not applicable

DefaultNot applicable

Last modified:

29-Sep-2015 First Release

Calculate**Calculate:Correction Commands**

Controls error correction functions.

CALCulate:MEASure:CORRection:**EDELay**| **DISTance**| **MEDium**| **TIME**| **UNIT**| **WGCutoff****[STATe]**| **INDicator?****TYPE**

Click on a [Red](#) keyword to view the command details.

See Also

- Example Programs
- Calibrating the VNA Using SCPI
- [Synchronizing the VNA and Controller](#)
- [SCPI Command Tree](#)

Critical Note: CALCulate commands act on the selected measurement. You can select one measurement for each channel using [Calc:Par:MNUM](#) or [Calc:Par>Select](#). [Learn more](#).

CALCulate<cnum>:MEASure<mnum>:CORRection:EDELay:DISTance <num>

Applicable Models: E5080A, M9485A

(Read-Write) Sets the electrical delay in physical length (distance) for the selected measurement.

[See Critical Note](#)

Parameters

- <cnum> Channel number of the measurement. There must be a selected measurement on that channel. If unspecified, <cnum> is set to 1.
- <mnum> Measurement number for each measurement. There must be a selected

measurement on the trace. If unspecified, <mnum> is set to 1.

<num> Electrical delay in distance.

First Specify units using [CALC:MCORR:EDEL:UNIT](#)

Use [SENS:CORR:RVEL:COAX](#) <num> to set Velocity factor.

This parameter supports MIN and MAX as arguments. [Learn more.](#)

Examples

```
CALC:MEAS:CORR:EDEL:DIST 5
calculate2:measure2:correction:distance .003
```

Query Syntax CALCulate<cnum>:MEASure<mnum>CORRection:EDELay:DISTance?

Return Type Numeric

Default 0

CALCulate<cnum>:MEASure<mnum>:CORRection:EDELay:MEDIum <char>

Applicable Models: E5080A, M9485A

(Read-Write) Sets the media used when calculating the electrical delay.

Parameters

<cnum> Channel number of the measurement. There must be a selected measurement on that channel. If unspecified, <cnum> is set to 1.

<mnum> Measurement number for each measurement. There must be a selected measurement on the trace. If unspecified, <mnum> is set to 1.

<char> Choose from: **COAX** for coaxial medium, **WAVE**guide for waveguide medium.

Examples

```
CALC:MEAS:CORR:EDEL:MED COAX
calculate3:measure2:correction:edelay:medium waveguide
```

Query Syntax CALCulate<cnum>:MEASure<mnum>:CORRection:EDELay:MEDIum?

Return Type Character

Default COAX

CALCulate<cnum>:MEASure<mnum>:CORRection:EDELay[:TIME] <num>

Applicable Models: E5080A, M9485A

(Read-Write) Sets the electrical delay for the selected measurement.

[See Critical Note](#)

Parameters

- <cnm> Channel number of the measurement. There must be a selected measurement on that channel. If unspecified, <cnm> is set to 1.
- <mnm> Measurement number for each measurement. There must be a selected measurement on the trace. If unspecified, <mnm> is set to 1.
- <num> Electrical delay in seconds. Choose any number between: **-10.00** and **10.00**
Use [SENS:CORR:RVEL:COAX](#) <num> to set Velocity factor.
This parameter supports MIN and MAX as arguments. [Learn more.](#)

Examples

```
CALC:MEAS:CORR:EDEL:TIME 1NS
calculate2:measure2:correction:edelay:time 0.5e-12
```

Query Syntax CALCulate<cnm>:MEASure<mnm>CORRection:EDELay[:TIME]?

Return Type Numeric

Default 0 seconds

CALCulate<cnm>:MEASure<mnm>:CORRection:EDELay:UNIT <char>

Applicable Models: E5080A, M9485A

(Read-Write) Sets and returns the units for specifying electrical delay in physical length (distance).

Parameters

- <cnm> Channel number of the measurement. There must be a selected measurement on that channel. If unspecified, <cnm> is set to 1.
- <mnm> Measurement number for each measurement. There must be a selected measurement on the trace. If unspecified, <mnm> is set to 1.
- <char> Units for delay in distance. Choose from:
METer
FEET
INCH

Examples

```
CALC:MEAS:CORR:EDEL:UNIT MET
calculate3:measure2:correction:edelay:unit inch
```

Query Syntax CALCulate<cnm>:MEASure<mnm>:CORRection:EDELay:UNIT?

Return Type Character

Default METer

CALCulate<cnum>:MEASure<mnum>:CORRection:EDELay:WGCutoff <num>

Applicable Models: E5080A, M9485A

(Read-Write) Sets the waveguide cutoff frequency used when the electrical delay media is set to WAVEguide. (See [CALCulate:CORRection:EDELay:MEDEium <char>](#).)

Parameters

- <cnum> Channel number of the measurement. There must be a selected measurement on that channel. If unspecified, <cnum> is set to 1.
- <mnum> Measurement number for each measurement. There must be a selected measurement on the trace. If unspecified, <mnum> is set to 1.
- <num> Waveguide cutoff frequency used with the electrical delay calculation. This parameter supports MIN and MAX as arguments. [Learn more.](#)

Examples

```
CALC:MEAS:CORR:EDEL:WGC 18.067 GHz
calculate3:measure2:correction:edelay:wgcutoff 14.047 ghz
```

Query Syntax CALCulate<cnum>:MEASure<mnum>:CORRection:EDELay:WGCutoff?

Return Type Numeric

Default 45 MHz

**CALCulate<cnum>:MEASure<mnum>:CORRection[:STATe] <bool>**

Applicable Models: E5080A, M9485A

(Read-Write) Turns error correction ON or OFF for the selected measurement on the specified channel. To turn error correction ON or OFF for a channel, use [SENS:CORR:STATe](#).

[See Critical Note](#)

Parameters

- <cnum> Channel number of the measurement. There must be a selected measurement on that channel. If unspecified, <cnum> is set to 1.
- <mnum> Measurement number for each measurement. There must be a selected measurement on the trace. If unspecified, <mnum> is set to 1.

<bool> Correction state. Choose from:
OFF or 0 - Correction OFF.
ON or 1 - Correction ON.

Examples `CALC:MEAS:CORR ON`
`calculate:measure:correction:state off`

Query Syntax `CALCulate<cnum>:MEASure<mnum>:CORRection:STATe?`

Return Type Boolean

Default Not Applicable

CALCulate<cnum>:MEASure<mnum>:CORRection[:STATe]:INDicator?

Applicable Models: E5080A, M9485A

(Read-only) Returns the error correction state for the selected measurement on the specified channel. To turn error correction ON or OFF for a channel, use [SENS:CORR:STATe](#).

[See Critical Note](#)

Parameters

<cnum> Channel number of the measurement. There must be a selected measurement on that channel. If unspecified, <cnum> is set to 1.

<mnum> Measurement number for each measurement. There must be a selected measurement on the trace. If unspecified, <mnum> is set to 1.

Examples `CALC:MEAS:CORR:IND?`
`calculate2:measure2:correction:state:indicator?`

Return Type Character

NONE - No error correction.

MAST (Master) - Original error correction terms.

INT - Error terms are interpolated. [Learn more](#).

DELT - Delta Match calibration terms. [Learn more](#).

INV - Error terms are not valid.

Default NONE

CALCulate<cnum>:MEASure<mnum>:CORRection:TYPE <string>

Applicable Models: E5080A, M9485A

(Read-Write) Sets the Cal Type for the selected measurement on the specified channel. This is used when a Cal Set is applied. Learn more about applying Cal Types.

- Use [SENS:CORR:TYPE:CAT?](#) to list the Cal Types in the VNA.
- Use [SENS:CORR:CSET:TYPE:CAT?](#) to list the Cal Types contained in the active Cal Set for the channel.
- Use [SENS:CORR:COLL:METH](#) to set the Cal type to perform a new Unguided calibration,

[See Critical Note](#)

Parameters

<cnm> Channel number of the measurement. There must be a selected measurement on that channel. If unspecified, <cnm> is set to 1.

<mnum> Measurement number for each measurement. There must be a selected measurement on the trace. If unspecified, <mnum> is set to 1.

<string> **(String)** Cal type. Case sensitive. Use one of the following:

For Full Calibrations (NO Power Cal included):

This command does not distinguish between TRL and SOLT. The same number of error terms is applied for both Cal Types.

"Full <n> Port(x,y,z...)"

where

<n> = the number of ports to calibrate

x,y,z = the port numbers to calibrate

For example:

```
"Full 4 Port(1,2,3,4)"
```

For Full Calibrations (including Power Cal):

After the Full <n> port, include the string, "with power"

For example:

```
"Full 4 Port with power(1,2,3,4)"
```

For Response Calibrations:

"Response(param)" OR

"ResponseAndIsolation(param)"

Where param =

- S-parameter. For example"

```
• "Response(S21)"
```

```
• "ResponseAndIsolation(A/R)"
```

- Single or ratioed receivers using either [logical receiver notation](#) or physical receiver notation. For example:

```
• "Response(A)"
```

- "ResponseAndIsolation(a3/b4)"

For Enhanced Response Calibrations:

"EnhancedResp(sourcePort, recPort)

Where:

- sourcePort = stimulus port number
- recPort = receiver port number

For FCA Calibrations:

Learn more about this setting.

- "SMC_2P" (Response + Input + Output) All four sweeps required. Most accurate.
- "SMCRsp+IN" No Output match. All four sweeps required.
- "SMCRsp+OUT" No Output match. All four sweeps required.
- "SMCRsp" No Input or Output match. Saves two sweeps.

For VMC, multiple Cal types are not available.

For Gain Compression Cal

where r = receive port; s = source port

- "GCA 2P (r,s)" - full 2-port cal
- "GCA Enh Resp (r,s)" - Enhanced Response Cal

Examples `CALC:MEAS:CORR:TYPE "Scalar Mixer Cal"`

Query Syntax `CALCulate<cnum>:MEASure<mnum>:CORRection:TYPE?`

Return Type String

Default Not Applicable

Last modified:

29-Sep-2015 First Release

Calculate:Data Commands

Controls writing and reading VNA measurement data.

CALCulate:DATA:

| [MFData](#)

| [MSData](#)

CALCulate:MEASure:DATA:

| [FDATa](#)

| [SDATa](#)

| [FMEMory](#)

| [SMEMory](#)

| [SNP?](#)

 | [PORTs?](#)

 | [SAVE](#)

CALCulate:MEASure:

| [RDATa](#)

Click on a [Red](#) keyword to view the command details.

See Also

- Example Programs
- Data Access Map
- [Synchronizing the Analyzer and Controller](#)
- To read receiver data, use [CALC:RDATA?](#)
- To read error terms, use [SENS:CORR:CSET:DATA](#)
- To read SnP measurement data, use [CALC:DATA:SNP?](#)
- [SCPI Command Tree](#)

CALCulate<cnum>:DATA<data>:MFData <string>

Applicable Models: E5080A, M9485A

(Read-only) Gets the formatted data array of multiple traces (traces-n, m, ... to l) of the selected channel.

This command is allows to get several trace data with one command, while [CALC:MEAS:DATA:FDAT](#) returns only one trace with one command.

Note: If valid data is not calculated because of the invalid measurement, "1.#QNB" is read out.

Parameters

<cnum> Channel number of the measurement. There must be a selected measurement on that channel. If unspecified, <cnum> is set to 1.

- <data> Indicates the array data (formatted data array) of NOP (number of measurement points) $\times 2 \times$ (number of specified traces). Where n is an integer between 1 and NOP.
- Data (n $\times 2$ -2) : Data (primary value) at the n-th measurement point.
 - Data (n $\times 2$ -1) : Data (secondary value) at the n-th measurement point. Always 0 when the data format is not the Smith chart format or the polar format.

The output trace data is listed according to the order of the specified trace number.

The index of the array starts from 0.

Note: If there is no array data of NOP (number of measurement point) $\times 2$ when setting a formatted data array, an error occurs when executed and the object is ignored.

- <string> Trace number. "n, m, l, ..." where n, m, l are 1 to the maximum trace number.

Note: Use comma for separator of trace number.

Examples CALC:DATA:MFD

Return Type Not Applicable

Default Not Applicable

CALCulate<cnum>:DATA<data>:MSData <string>

Applicable Models: E5080A, M9485A

(Read-only) Gets the corrected data array of multiple traces (traces-n, m, to l) of the selected channel.

This command allows to get several corrected data with one command, while

[CALC:MEAS:DATA:SDAT](#) returns only one corrected data with one command.

Note: If valid data is not calculated because of the invalid measurement, "1.#QNB" is read out.

Parameters

- <cnum> Channel number of the measurement. There must be a selected measurement on that channel. If unspecified, <cnum> is set to 1.
- <data> Indicates the array data (corrected data array) of NOP (number of measurement points) $\times 2 \times$ (number of specified traces). Where n is an integer between 1 and NOP.
- Data(n $\times 2$ -2) : Real part of the data (complex number) at the n-th measurement point.
 - Data(n $\times 2$ -1) : Imaginary part of the data (complex number) at the n-th measurement point.

The output trace data is listed according to the order of the specified trace number.

The index of the array starts from 0.

Note: If there is no array data of NOP (number of measurement point) $\times 2$ when setting a corrected data array, an error occurs when executed and the object is

ignored.

<string> Trace number. "n, m, l, ..." where n, m, l are 1 to the maximum trace number.

Note: Use comma for separator of trace number.

Examples `CALC:DATA:MSD`

Return Type Not Applicable

Default Not Applicable

(Write) CALCulate<cnum>:MEASure<mnum>:DATA:<char>,<data>

(Read) CALCulate<cnum>:MEASure<mnum>:DATA:<char>?

Reads or writes Measurement data, Memory data or Normalization Divisor data from the [Data Access Map](#) location.

- For Measurement data, use FDATA or SDATA
- For Memory data, use FMEM or SMEM. When querying memory, you must first store a trace into memory using [CALC:MATH:MEMorize](#).
- For Normalization Divisor (Receiver Power Cal error term) data, use SDIV.
- Use [FORMat:DATA](#) to change the data type (<REAL,32>, <REAL,64> or <ASCIi,0>).
- Use [FORMat:BORDER](#) to change the byte order. Use "NORMal" when transferring a binary block from LabView or VEE. For other programming languages, you may need to "SWAP" the byte order.

Equation Editor Notes:

- When equation editor is active on a trace in a standard S-parameter channel, Calc:Data returns the data from the parameter on the trace that was measured last. For example, for the equation "S22 + S33 + S11", then S33 is the last measured parameter because it uses source port 3.
- In applications, if equation editor is active and the original parameter for the trace is not requested anywhere in the channel, then zeros are returned. If the original parameter is being measured within the channel, then data for the original parameter is returned.
- In general, if an equation contains no measurement parameters, then data for the original parameter is returned.

Note: The Calc:Data SCORR command to read/write error terms is **Superseded** with [SENS:CORR:CSET:DATA](#). SCORR commands do NOT accommodate greater than 12 error terms.

Parameters

- <cnum> Channel number of the measurement. There must be a selected measurement on that channel. If unspecified, <cnum> is set to 1.
- <mnum> Measurement number for each measurement. There must be a selected measurement on the trace. If unspecified, <mnum> is set to 1.
- <char> **FDATA** Formatted **measurement** data to or from [Data Access Map](#) location. **Display** (access point 2).

- Corrected data is returned when correction is ON.
- Uncorrected data is returned when correction is OFF.
- Returns TWO numbers per data point for Polar and Smith Chart format.
- Returns one number per data point for all other formats.
- Format of the read data is same as the displayed format.

SDATA Complex measurement data.

Writes data to [Data Access Map](#) location. **Raw Measurement** (access point 0).

- When writing corrected data, and correction is ON, it will be corrected again, resulting in meaningless data.

Reads data from **Apply Error Terms** (access point 1).

- Returns TWO numbers per data point.
- Corrected data is returned when correction is ON.
- Uncorrected data is returned when correction is OFF.

FMEM Formatted memory data to or from [Data Access Map](#) location. **Memory result** (access point 4).

- Returns TWO numbers per data point for Polar and Smith Chart format.
- Returns one number per data point for all other formats.
- Format of the read data is same as the displayed format.
- Returned data reflects the correction level (ON|OFF) when the data was stored into memory.

SMEM Complex measurement data to or from [Data Access Map](#) location **Memory** (access point 3).

- Returns TWO numbers per data point.
- Returned data reflects the correction level (ON|OFF) when the data was stored into memory.
- Returned data reflects the correction level (ON|OFF) when the data was stored into memory.

Examples

```
CALC:MEAS:DATA:FDATA Data(x)
calculate2:measure2:data:sdata data(r,i)
See another example using this command.
```

Return Type [Block data](#)

Default Not Applicable

CALCulate<cnum>:MEASure<mnum>:DATA:SNP:PORTs? <"x,y,z".>

Note: This command replaces [CALC:DATA:SNP?](#). This command is more explicit regarding the data to be returned, and works for VNAs with multiport test sets.

(Read-only) Reads SNP data from the selected measurement for the specified ports. [Learn more about SNP data.](#)

This command is valid **ONLY** with standard S-parameter measurements.

Notes:

- This command returns SNP data without header information, and in columns, not in rows as .SnP files. This means that the data returned from this command sends all frequency data, then all Sx1 magnitude or real data, then all Sx1 phase or imaginary data, and so forth.
- To avoid frequency rounding errors, specify [FORM:DATA](#) <Real,64> or <ASCIi, 0>
- Data that is not available is zero-filled.
- For sweeps with a large number of data points, always follow this command with *OPC? [Learn more.](#)

Parameters

- <cnm> Channel number of the measurement. There must be a selected measurement on that channel. If unspecified, <cnm> is set to 1.
- <mnum> Measurement number for each measurement. There must be a selected measurement on the trace. If unspecified, <mnum> is set to 1.
- <"x,y,z"> Comma or space delimited port numbers for which data is requested, enclosed in quotes.
- SNP data can be output using several data formatting options. See [MMEM:STOR:TRAC:FORM:SNP](#).

Examples `CALC:MEAS:DATA:SNP:PORTs? "1,2,4,5,7" 'read data for these ports`

Return Type Depends on [FORM:DATA](#) command

Default Not Applicable

CALCulate<cnm>:MEASure<mnum>:DATA:SNP:PORTs:SAVE <"x,y,z">,<filename>

Applicable Models: E5080A, M9485A

(Write-only) Saves SNP data from the selected measurement for the specified ports. [Learn more about SNP data.](#)

- The Normal vs Mixed Mode selection is NOT used as it is in the [Choose Ports dialog](#). Instead, data is returned as it is displayed on the trace. If the selected measurement is Mixed Mode (balanced), then balanced data is returned. If the selected measurement is an S-parameter, then S-parameter data is returned.
- This command is valid **ONLY** with the Standard measurement class (NOT applications).

- Data that is not available is zero-filled.
- For sweeps with a large number of data points, always follow this command with *OPC? [Learn more.](#)

Parameters

- <cnm> Channel number of the measurement. There must be a selected measurement on that channel. If unspecified, <cnm> is set to 1.
- <mnum> Measurement number for each measurement. There must be a selected measurement on the trace. If unspecified, <mnum> is set to 1.
- <"x,y,z"> **String** - Comma or space delimited port numbers for which data is requested, enclosed in quotes.
- <filename> **String** - Path, filename, and suffix of location to store the SNP data. The suffix is not checked for accuracy. If saving 2 ports, specify "filename.s2p"; If saving 4 ports, specify "filename.s4p.", and so forth.
- SNP data can be output using several data formatting options. See [MMEM:STOR:TRAC:FORM:SNP](#).

Examples

```
CALC:MEAS:DATA:SNP:PORTs:Save '1,2,4','D:\MyData.s3p';*OPC?
```

Return Type Depends on [FORM:DATA](#) command

Default Not Applicable

CALCulate<cnm>:MEASure<mnum>:RDATa? <char>

Applicable Models: E5080A, M9485A

(Read-only) Returns receiver data for the selected measurement. To query measurement data, see [CALC:DATA?](#)

Critical Note: CALCulate commands act on the selected measurement. [Learn more.](#)

Parameters

- <cnm> Channel number of the measurement. There must be a selected measurement on that channel. If unspecified, <cnm> is set to 1.
- <mnum> Measurement number for each measurement. There must be a selected measurement on the trace. If unspecified, <mnum> is set to 1.
- <char> Choose from any physical receiver in the VNA.
For example: "A"
- Also, **REF** - returns data for either R1 or R2 data depending on the source port of the selected measurement.

See the [block diagram](#) showing the receivers in VNA.

Note: Logical receiver notation is NOT allowed with this command. [Learn more.](#)

Example

```
INITiate:CONTinuous OFF
INITiate:IMMediate;*wai
CALC:MEAS:RDATA? A
CALCulate:RDATA? REF
```

Return Type Depends on [FORM:DATA](#) command - Two numbers per data point

Default Not Applicable

Notes:

Generally when you query the analyzer for data, you expect that the number of data values returned will be consistent with the number of points in the sweep.

However, if you query **receiver** data while the instrument is sweeping, the returned values may contain zeros. For example, if your request for receiver data is handled on the 45th point of a 201 point sweep, the first 45 values will be valid data, and the remainder will contain complex zero.

This can be avoided by synchronizing this request with the end of a sweep or putting the channel in hold mode.

[Learn about Unratioed Measurements](#)

Last modified:

29-Sep-2015 First Release

Calculate:Equation Commands

Controls Equation Editor capabilities.

CALCulate:EQUation:**LIBRary**| **FUNCtions**| **IMPort?**| **REMOve****STATe****TEXT****VALid?**

Click on a **Red** keyword to view the command details.

See Also

- Example Programs
- [Learn about Equation Editor](#)
- [Synchronizing the VNA and Controller](#)
- [SCPI Command Tree](#)

CALCulate:EQUation:LIBRary:FUNCtions <string>

Applicable Models: E5080A, M9485A

(Read-only) Returns the functions in the specified DLL.

Parameters

<string> Full path and filename of the *.dll to be read.

Examples `functions = CALC:EQU:LIBR:FUNC "Expansion.dll"`

Return Type Comma delimited string of function names.

Default Not Applicable

CALCulate:EQUation:LIBRary:IMPort <string>

Applicable Models: E5080A, M9485A

(Read-Write) Imports the functions in the specified DLL and returns whether the functions have been imported into the VNA.

Parameters

<string> Full path and filename of the *.dll.

Examples

```
'Write - Imports functions
CALC:EQU:LIBR:IMPORt "D:\Expansion.dll"
'Read if Imported
functions = CALC:EQU:LIBR:IMPORt "D:\Expansion.dll"
```

Query Syntax CALCulate:EQUation:LIBRary:IMPORt?

Returns the following:

1 - Imported

0 - NOT imported

Return Type Boolean

Default Not Applicable

CALCulate:EQUation:LIBRary:REMOve <string>

Applicable Models: E5080A, M9485A

(Write-only) Removes an imported an Equation Editor DLL from the VNA.

Parameters

<string> Full path and filename of the *.dll.

Examples

```
CALC:EQU:LIBR:REM "D:\Expansion.dll"
```

Query Syntax Not Applicable

Default Not Applicable

CALCulate<cnum>:EQUation[:STATe] <bool>

Applicable Models: E5080A, M9485A

(Read-Write) Turns ON and OFF the equation on selected measurement for the specified channel. If the equation is not valid, then processing is not performed. Use [CALC:EQU:VAL?](#) to ensure that the equation is valid.

[See Critical Note](#)

Parameters

<cnun> Channel number of the measurement. There must be a selected measurement on that channel. If unspecified, <cnun> is set to 1.

<bool> **ON or 1** - turns equation ON.

OFF or 0 - turns equation OFF.

Examples

```
CALC:EQU 1
calculate2:equation:state 0
```

Query Syntax CALCulate<cnun>:EQUation[:STATe]?

Return Type Boolean

Default OFF (0)

CALCulate<cnun>:EQUation:TEXT <string>

Applicable Models: E5080A, M9485A

(Read-Write) Specifies an equation or expression to be used on the selected measurement for the specified channel.

[See Critical Note](#)

Parameters

<cnun> Channel number of the measurement. There must be a selected measurement on that channel. If unspecified, <cnun> is set to 1.

<string> Any valid equation or expression. [See Equation Editor](#).

Examples

```
'Equation (includes '=')
CALC:EQU:TEXT "foo=S11/S21"
'Expression
calculate2:equation:text "S11/S21"
```

Query Syntax CALCulate<cnun>:EQUation:TEXT?

Return Type String

Default Not Applicable

CALCulate<cnun>:EQUation:VALid?

Applicable Models: E5080A, M9485A

(Read-Only) Returns a boolean value to indicate if the current equation on the selected measurement for

the specified channel is valid. For equation processing to occur, the equation must be valid and ON ([CALC:EQU:STAT 1](#)).

[See Critical Note](#)

Parameters

<cnum> Channel number of the measurement. There must be a selected measurement on that channel. If unspecified, <cnum> is set to 1.

Examples

```
CALC:EQU:VAL?  
calculate2:equation:valid?
```

Return Type

Boolean
1 - equation is valid
0 - equation is NOT valid

Default Not Applicable

Last modified:

29-Sep-2015 First Release

Calculate:Filter Commands

Controls the gating function used in time domain measurements. The gated range is specified with either (start/stop) or (center/span) commands.

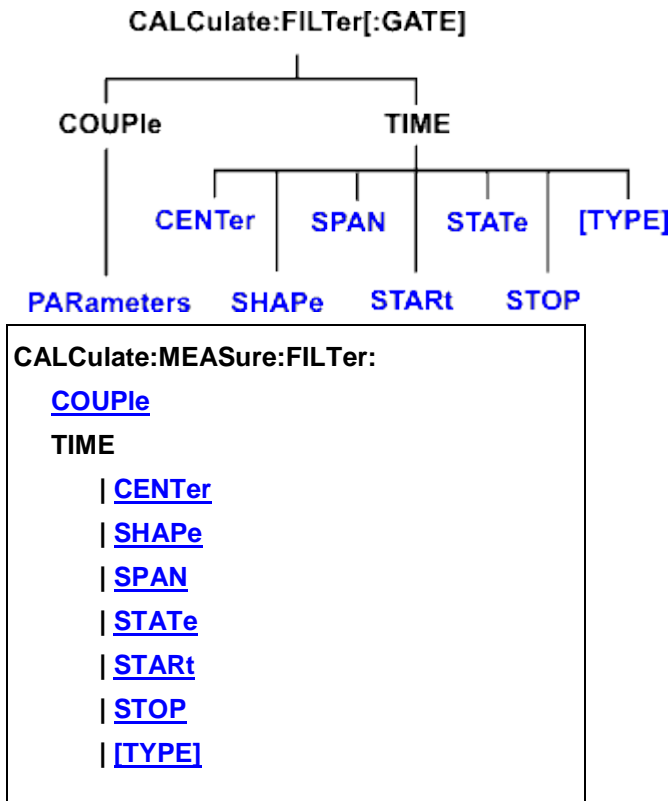

Click on a [Red](#) keyword to view the command details.

See Also

- [Example Programs](#)
- [Learn about Gating](#)
- [Synchronizing the VNA and Controller](#)
- [SCPI Command Tree](#)

Critical Note: CALCulate commands act on the selected measurement. You can select one measurement for each channel using [Calc:Par:MNUM](#) or [Calc:Par:Select](#). [Learn more](#).

CALCulate<cnum>:MEASure<mnum>:FILTer[:GATE]:COUPlE:PARAmeters <num>

Applicable Models: E5080A, M9485A

(Read-Write) Specifies the time domain gating parameters to be coupled. The settings for those parameters will be copied from the selected measurement to all other measurements on the channel.

- To enable Trace Coupling, use [SENS:COUP:PAR](#)

- To specify Transform parameters to couple, use [CALC:TRAN:COUP:PAR](#)

Learn more about Time Domain Trace Coupling

[See Critical Note](#)

Parameters

- <cnm> Channel number of the measurement. There must be a selected measurement on that channel. If unspecified, <cnm> is set to 1.
- <mnum> Measurement number for each measurement. There must be a selected measurement on the trace. If unspecified, <mnum> is set to 1.
- <num> (Numeric) Parameters to couple. To specify more than one parameter, add the numbers.
- 1 - Gating Stimulus (Start, Stop, Center, and Span TIME settings).
 - 2 - Gating State (ON | OFF).
 - 4 - Gating Shape (Minimum, Normal, Wide and Maximum).
 - 8 - Gating Type (Bandpass and Notch)

Examples

```
'To couple all parameters:
CALC:MEAS:FILT:COUP:PAR 15
'To couple Stimulus and Type:
calculate2:measure2:filter:gate:couple:parameters 9
```

Query Syntax CALCulate<cnm>:MEASure<mnum>:FILTer:GATE:COUPle:PARAmeters?

Return Type Numeric

Default 13 (All parameters except 2 - Gating State)

CALCulate<cnm>:MEASure<mnum>:FILTer[:GATE]:TIME:CENTer <num>

Applicable Models: E5080A, M9485A

(Read-Write) Sets the gate filter center time.

[See Critical Note](#)

Parameters

- <cnm> Channel number of the measurement. There must be a selected measurement on that channel. If unspecified, <cnm> is set to 1.
- <mnum> Measurement number for each measurement. There must be a selected measurement on the trace. If unspecified, <mnum> is set to 1.
- <num> Center time in seconds; Choose any number between:
± (number of points-1) / frequency span

Note: This command will accept **MIN** or **MAX** instead of a numeric parameter. See

[SCPI Syntax](#) for more information.

Examples `CALC:MEAS:FILT:GATE:TIME:CENT -5 ns`
`calculate2:measure2:filter:time:center maximum`

Query Syntax `CALCulate<cnum>:MEASure<mnum>:FILTer[:GATE]:TIME:CENTer?`

Return Type Numeric

Default 0

CALCulate<cnum>:MEASure<mnum>:FILTer[:GATE]:TIME:SHAPE <char>

Applicable Models: E5080A, M9485A

(Read-Write) Sets the gating filter shape when in time domain.

[See Critical Note](#)

Parameters

- <cnum> Channel number of the measurement. There must be a selected measurement on that channel. If unspecified, <cnum> is set to 1.
- <mnum> Measurement number for each measurement. There must be a selected measurement on the trace. If unspecified, <mnum> is set to 1.
- <char> Choose from
MAXimum - the widest gate filter available
WIDE
NORMAL
MINimum - the narrowest gate filter available

Examples `CALC:MEAS:FILT:GATE:TIME:SHAP MAX`
`calculate2:measure2:filter:time:shape normal`

Query Syntax `CALCulate<cnum>:MEASure<mnum>:FILTer[:GATE]:TIME:SHAPE?`

Return Type Character

Default NORMAL

CALCulate<cnum>:MEASure<mnum>:FILTer[:GATE]:TIME:SPAN <num>

Applicable Models: E5080A, M9485A

(Read-Write) Sets the gate filter span time.

[See Critical Note](#)

Parameters

- <cnum> Channel number of the measurement. There must be a selected measurement on that channel. If unspecified, <cnum> is set to 1.
- <mnum> Measurement number for each measurement. There must be a selected measurement on the trace. If unspecified, <mnum> is set to 1.
- <num> Time span in seconds; Choose any number between:
0 and $2 * [(number\ of\ points - 1) / frequency\ span]$

Note: This command will accept **MIN** or **MAX** instead of a numeric parameter. See [SCPI Syntax](#) for more information.

Examples

```
CALC:MEAS:FILT:GATE:TIME:SPAN 5 ns
calculate2:measure2:filter:time:span maximum
```

Query Syntax CALCulate<cnum>:MEASure<mnum>:FILTer[:GATE]:TIME:SPAN?

Return Type Numeric

Default 20 ns

CALCulate<cnum>:MEASure<mnum>:FILTer[:GATE]:TIME:STATe <bool>

Applicable Models: E5080A, M9485A

(Read-Write) Turns gating state ON or OFF.

[See Critical Note](#)

Note: Sweep type must be set to Linear Frequency in order to use Transform Gating.

Parameters

- <cnum> Channel number of the measurement. There must be a selected measurement on that channel. If unspecified, <cnum> is set to 1.
- <mnum> Measurement number for each measurement. There must be a selected measurement on the trace. If unspecified, <mnum> is set to 1.
- <bool> **ON** or **1** - turns gating ON.
OFF or **0** - turns gating OFF.

Examples

```
CALC:MEAS:FILT:TIME:STAT ON
calculate2:measure2:filter:gate:time:state off
```

Query Syntax CALCulate<cnum>:MEASure<mnum>:FILTer[:GATE]:TIME:STATe?

Return Type Boolean

Default OFF

CALCulate<cnum>:MEASure<mnum>:FILTer[:GATE]:TIME:START <num>

Applicable Models: E5080A, M9485A

(Read-Write) Sets the gate filter start time.

[See Critical Note](#)

Parameters

- <cnm> Channel number of the measurement. There must be a selected measurement on that channel. If unspecified, <cnm> is set to 1.
- <mnum> Measurement number for each measurement. There must be a selected measurement on the trace. If unspecified, <mnum> is set to 1.
- <num> Start time in seconds; any number between:
 $\pm (\text{number of points}-1) / \text{frequency span}$

Note: This command will accept **MIN** or **MAX** instead of a numeric parameter. See [SCPI Syntax](#) for more information.

Examples

```
CALC:MEAS:FILT:TIME:STAR 1e-8
calculate2:measure2:filter:gate:time:start minimum
```

Query Syntax CALCulate<cnm>:MEASure<mnum>:FILTer[:GATE]:TIME:STARt?

Return Type Numeric

Default 10 ns

CALCulate<cnm>:MEASure<mnum>:FILTer[:GATE]:TIME:STOP <num>

Applicable Models: E5080A, M9485A

(Read-Write) Sets the gate filter stop time.

[See Critical Note](#)

Parameters

- <cnm> Channel number of the measurement. There must be a selected measurement on that channel. If unspecified, <cnm> is set to 1.
- <mnum> Measurement number for each measurement. There must be a selected measurement on the trace. If unspecified, <mnum> is set to 1.
- <num> Stop time in seconds; any number between:
 $\pm (\text{number of points}-1) / \text{frequency span}$

Note: This command will accept **MIN** or **MAX** instead of a numeric parameter. See [SCPI Syntax](#) for more information.

Examples

```
CALC:MEAS:FILT:TIME:STOP -1 ns
calculate2:measure2:filter:gate:time:stop maximum
```

Query Syntax CALCulate<cnm>:MEASure<mnum>:FILTer[:GATE]:TIME:STOP?

Return Type Numeric

Default 10 ns

CALCulate<cnum>:MEASure<mnum>:FILTer[:GATE]:TIME[:TYPE] <char>

Applicable Models: E5080A, M9485A

(Read-Write) Sets the type of gate filter used.

[See Critical Note](#)

Parameters

- <cnum> Channel number of the measurement. There must be a selected measurement on that channel. If unspecified, <cnum> is set to 1.
- <mnum> Measurement number for each measurement. There must be a selected measurement on the trace. If unspecified, <mnum> is set to 1.
- <char> Choose from:
BPASs - Includes (passes) the range between the start and stop times.
NOTCh - Excludes (attenuates) the range between the start and stop times.

Examples

```
CALC:MEAS:FILT:TIME BPAS
calculate2:measure2:filter:gate:time:type notch
```

Query Syntax CALCulate<cnum>:MEASure<mnum>:FILTer[:GATE]:TIME[:TYPE]?

Return Type Character

Default BPAS

Last modified:

29-Sep-2015 First Release



Calculate:Format Commands

Controls format functions.

CALCulate:MEASure:FORMat:
UNIT

See Also

- Example using this command.
 - [Learn About Data Format](#)
 - [Synchronizing the VNA and Controller](#)
-

CALCulate<cnum>:MEASure<mnum>:FORMat <char>

Applicable Models: E5080A, M9485A

(Read-Write) Sets the display format for the measurement.

Parameters

- <cnum> Channel number of the measurement. There must be a selected measurement on that channel. If unspecified, <cnum> is set to 1.
- <mnum> Measurement number for each measurement. There must be a selected measurement on the trace. If unspecified, <mnum> is set to 1.
- <char> Choose from:
- MLINear** - Linear magnitude
 - MLOGarithmic** - Logarithmic magnitude
 - PHASe**
 - UPHase** - Unwrapped phase
 - IMAGinary** - Imaginary part (Im)
 - REAL** - Real part (Re)
 - POLar** - (Re, Im)
 - SMITH**
 - SADMittance** - Smith Admittance
 - SWR** - Standing Wave Ratio
 - GDELay** - Group Delay

Examples

```
CALC:MEAS:FORM MLIN
calculate2:measure2:format polar
```

Query Syntax CALCulate<cnum>:MEASure<mnum>:FORMat?

Return Type Character

Default MLINear

CALCulate<cnum>:MEASure<mnum>:FORMat:UNIT <dataFormat>, <units>

Applicable Models: E5080A, M9485A

(Read-Write) Sets and returns the units for the specified data format. Measurements with display formats other than those specified are not affected.

[See Critical Note](#)

Parameters

- <cnum> Channel number of the measurement. There must be a selected measurement on that channel. If unspecified, <cnum> is set to 1.
- <mnum> Measurement number for each measurement. There must be a selected measurement on the trace. If unspecified, <mnum> is set to 1.
- <dataFormat> Choose MLOG.
- <units> For unratiod measurements, choose from:
- **DBM** Units are displayed in dBm. 0 dBm = 0.001 watt
 - **DBMV** Units are displayed in dBmV. 0 dBmV = 0.001 volt

Examples

```
CALC:MEAS:FORM MLOG, DBM
calculate2:measure2:format mlog, dbmv
```

Query Syntax CALCulate<cnum>:MEASure<mnum>:FORMat:UNIT?

Return Type Character

Default DBM

Last modified:

29-Sep-2015 First Release

[Calculate:FSimulator Commands](#)

Specifies settings and fixturing for Balanced Measurements.

CALCulate:FSIMulator**BALun** [More commands](#)**EMBed** [More commands](#)**SENDeD** [More commands](#)[SNP:EXTRapolate](#)[STATe](#)**CALCulate:**[DTOPology](#)

Click a [Red](#) keyword to view the command details.

See Also

- [Example Programs](#)
- [SCPI Command Tree](#)

CALCulate<cnum>:FSIMulator:SNP:EXTRapolate <bool>
Applicable Models: E5080A, M9485A

([Read-Write](#)) Turns ON and OFF SNP file extrapolation for both 2-port and 4-port embedding/de-embedding. [Learn more.](#)

Note: This command affects ALL measurements on the specified channel.

Parameters

<cnum> Channel number of the measurement. There must be a selected measurement on that channel. If unspecified, <cnum> is set to 1.

<bool> Choose from:
ON or 1 - Turns Extrapolation ON.
OFF or 0 - Turns Extrapolation OFF.

Examples

```
CALC:FSIM:SNP:EXTR 1
calculate2:fsimulator:snp:extrapolate 0
```

Query Syntax CALCulate<cnum>:FSIMulator:SNP:EXTRapolate?

Return Type Boolean

Default OFF

CALCulate<cnum>:FSIMulator:STATE <bool>

Applicable Models: E5080A, M9485A

(Read-Write) Turns all three fixturing functions (de-embedding, port matching, impedance conversion) ON or OFF for all ports on the specified channel. Does not affect port extensions.

Note: This command affects ALL measurements on the specified channel.

Parameters

- <cnum> Channel number of the measurement. There must be a selected measurement on that channel. If unspecified, <cnum> is set to 1.
- <bool> Choose from:
ON or 1 - Turns Fixturing ON.
OFF or 0 - Turns Fixturing OFF.

Examples

```
CALC:FSIM:STAT 1
calculate2:fsimulator:state 0
```

Query Syntax CALCulate<cnum>:FSIMulator:STATE?

Return Type Boolean

Default OFF or 0

CALCulate<cnum>:DTopology <device>, <topology>

Applicable Models: E5080A, M9485A

(Write-only) Defines the device type and the topology for a balanced measurement.

This command will replace the following commands:

CALC:FSIM:BAL:TOP:SBAL[:PPOR]

CALC:FSIM:BAL:TOP:SSB[:PPOR]

CALC:FSIM:BAL:TOP:BBAL[:PPOR]

CALC:FSIM:BAL:TOP:BALS[:PPOR]

Parameters

- <cnum> Channel number of the measurement. There must be a selected measurement on that channel. If unspecified, <cnum> is set to 1.
- <device> (String) Device type for the balanced measurement. 'B' means the Balanced port; 'S' means the Single-ended port. Choose from:
 B – 1 port balanced device (2 ports)
 BB – Balanced - Balanced device (4 ports)

BS – Balanced - Single-ended device (3 ports)

SB – Single-ended - Balanced device (3 ports)

SSB – Single-ended - Single-ended - Balanced device (4 ports)

<topology> (Int array) Physical port numbers mapped to the logical ports, separated by ','.
'B' (Balanced) requires 2 physical port numbers: <nPos>, <nNeg>.
'S' (Single-ended) requires 1 physical port number.

Examples

```
CALC:DTOP "SB", 2, 1, 4  
calculate:dtology "SB", 2, 1, 4
```

Query Syntax CALCulate<cnum>:DTOPology <device>, <topology>?

Return Type Not Applicable

Default Not Applicable

Last modified:

29-Sep-2015 First Release

Calculate:Function Commands

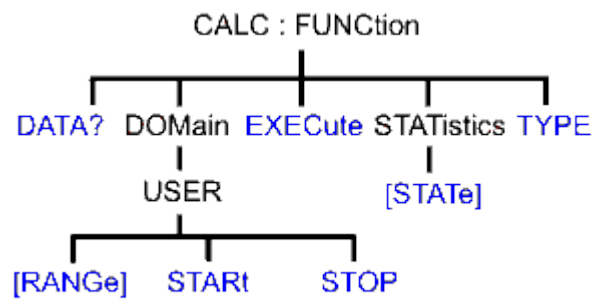

CALCulate:MEASure:FUNCTION:

[DATA](#)

DOMain

| [USER](#)| [\[RANGe\]](#)| [START](#)| [STOP](#)[EXECute](#)[STATistics](#)[TYPE](#)

Click on a **Red** keyword to view the command details.

See Also

- Example Programs
- [Learn about Trace Statistics](#)
- [Synchronizing the VNA and Controller](#)
- [SCPI Command Tree](#)

CALCulate<cnum>:MEASure<mnum>:FUNCTION:DATA?

Applicable Models: E5080A, M9485A

(Read-only) Returns the trace statistic data for the selected statistic type for the specified channel. Select the type of statistic with [CALC:FUNC:TYPE](#).

[See Critical Note](#)

Parameters

<cnum> Channel number of the measurement. There must be a selected measurement on that channel. If unspecified, <cnum> is set to 1.

<mnum> Measurement number for each measurement. There must be a selected measurement on the trace. If unspecified, <mnum> is set to 1.

Return Type Depends on [FORM:DATA](#)

Examples
`CALC:MEAS:FUNC:DATA?`
`calculate2:measure2:function:data?`

Default Not Applicable

CALCulate<cnum>:MEASure<mnum>:FUNction:DOMain:USER[:RANGe] <range>

Applicable Models: E5080A, M9485A

(Read-Write) Sets the range used to calculate trace statistics. Each channel has 16 user ranges. The x-axis range is specified with the [CALC:FUNC:DOM:USER:START](#) and [STOP](#) commands.

[See Critical Note](#)

Parameters

<cnum> Channel number of the measurement. There must be a selected measurement on that channel. If unspecified, <cnum> is set to 1.

<mnum> Measurement number for each measurement. There must be a selected measurement on the trace. If unspecified, <mnum> is set to 1.

<range> Range number. Choose from: **0 to 16**
0 is Full Span of the current x-axis range
1 to 16 are user-specified ranges

Examples
`CALC:MEAS:FUNC:DOM:USER 4`
`calculate2:measure2:function:domain:user:range 0`

Query Syntax `CALCulate<cnum>:MEASure<mnum>:FUNction:DOMain:USER[:RANGe]?`

Return Type Numeric

Default Full Span

CALCulate<cnum>:MEASure<mnum>:FUNction:DOMain:USER:STARt <range>, <start>

Applicable Models: E5080A, M9485A

(Read-Write) Sets the start of the specified user-domain range.

To apply this range, use [CALC:FUNC:DOM:USER](#)

To set the stop of the range, use [CALC:FUNC:DOM:USER:STOP](#).

[See Critical Note](#)

Note: This command does the same as [CALC:MARK:FUNC:DOM:USER:STAR](#)

Parameters

- <cnum> Channel number of the measurement. There must be a selected measurement on that channel. If unspecified, <cnum> is set to 1.
- <mnum> Measurement number for each measurement. There must be a selected measurement on the trace. If unspecified, <mnum> is set to 1.
- <range> Range number that will receive the start value. Choose an integer between **1** and **16**
- <start> Start value of the specified range. Choose a real number between: the analyzer's **Minimum** and **Maximum** x-axis value.

Examples

```
CALC:MEAS:FUNC:DOM:USER:STAR 1,1e9
calculate2:measure2:function:domain:user:start 2,2e9
```

Query Syntax CALCulate<cnum>:MEASure<mnum>:FUNCTion:DOMain:USER:STARt? <range>

Return Type Numeric

Default The analyzer's **Minimum** x-axis value

CALCulate<cnum>:MEASure<mnum>:FUNCTion:DOMain:USER:STOP <range>, <stop>

Applicable Models: E5080A, M9485A

(Read-Write) Sets the stop value of the specified user-domain range.

To apply this range, use [CALC:FUNC:DOM:USER](#).

To set the start of the range, use [CALC:FUNC:DOM:USER:START](#)

[See Critical Note](#)

Note: This command does the same as [CALC:MARK:FUNC:DOM:USER:STOP](#)

Parameters

- <cnum> Channel number of the measurement. There must be a selected measurement on that channel. If unspecified, <cnum> is set to 1.
- <mnum> Measurement number for each measurement. There must be a selected measurement on the trace. If unspecified, <mnum> is set to 1.
- <range> Range number that will receive the stop value. Choose an integer between **1** and **16**
- <stop> Stop value of the specified range. Choose a real number between: the analyzer's **Minimum** and **Maximum** x-axis value.

Examples

```
CALC:MEAS:FUNC:DOM:USER:STOP 4,5e9
calculate2:measure2:function:domain:user:stop 3,8e9
```

Query Syntax CALCulate<cnum>:MEASure<mnum>:FUNCTion:DOMain:USER:STOP? <range>

Return Type Numeric

Default The analyzer's **Maximum** x-axis value

CALCulate<cnum>:MEASure<mnum>:FUNction:EXECute

Applicable Models: E5080A, M9485A

(Write-only) For the active trace of specified channel, executes the statistical analysis specified by the [CALC:FUNC:TYPE](#) command.

[See Critical Note](#)

Parameters

<cnum> Channel number of the measurement. There must be a selected measurement on that channel. If unspecified, <cnum> is set to 1.

<mnum> Measurement number for each measurement. There must be a selected measurement on the trace. If unspecified, <mnum> is set to 1.

Examples

```
CALC:MEAS:FUNC:EXEC
calculate2:measure2:function:execute
```

Query Syntax Not Applicable

Default Not Applicable

CALCulate<cnum>:MEASure<mnum>:FUNction:STATistics[:STATe] <bool>

Applicable Models: E5080A, M9485A

(Read-Write) Displays and hides the trace statistics (peak-to-peak, mean, standard deviation) on the screen.

The analyzer will display either measurement statistics or Filter Bandwidth statistics; not both.

[See Critical Note](#)

Parameters

<cnum> Channel number of the measurement. There must be a selected measurement on that channel. If unspecified, <cnum> is set to 1.

<mnum> Measurement number for each measurement. There must be a selected measurement on the trace. If unspecified, <mnum> is set to 1.

<bool> **ON or 1** - Displays trace statistics
OFF or 0 - Hides trace statistics

Examples

```
CALC:MEAS:FUNC:STAT ON
calculate2:measure2:function:statistics:state off
```

Query Syntax CALCulate<cnum>:MEASure<mnum>:FUNCtion:STATistics[:STATe]?

Return Type Boolean

Default OFF

CALCulate<cnum>:MEASure<mnum>:FUNCtion:TYPE <char>

Applicable Models: E5080A, M9485A

(Read-Write) Sets statistic TYPE that you can then query using [CALC:FUNCtion:DATA?](#).

Note: this command affects only the selected measurement on the specified channel.

[See Critical Note](#)

Parameters

- <cnum> Channel number of the measurement. There must be a selected measurement on that channel. If unspecified, <cnum> is set to 1.
- <mnum> Measurement number for each measurement. There must be a selected measurement on the trace. If unspecified, <mnum> is set to 1.
- <char> Choose from:
 - PTPeak** - the difference between the max and min data points on the trace.
 - STDEV** - standard deviation of all data points on the trace
 - MEAN** - mean (average) of all data points on the trace
 - MIN** - lowest data point on the trace
 - MAX** - highest data point on the trace

Examples

```
CALC:MEAS:FUNC:TYPE PTP
calculate2:measure2:function:type stdev
```

Query Syntax CALCulate<cnum>:MEASure<mnum>:FUNCtion:TYPE?

Return Type Character

Default PTPeak

Last modified:

29-Sep-2015 First Release



Group Delay Aperture Commands

Controls the Aperture setting used to make Group Delay measurements.

CALCulate:MEASure:GDElay

FREQuency

PERCent

POINts

Click on a [Red](#) keyword to view the command details.

See Also

- [Learn about Group Delay Aperture](#)
- Example Programs
- [Synchronizing the VNA and Controller](#)
- [SCPI Command Tree](#)

Critical Note: CALCulate commands act on the selected measurement. You can select one measurement for each channel using [Calc:Par:MNUM](#) or [Calc:Par:Select](#). [Learn more](#).

CALCulate<cnum>:MEASure<mnum>:GDElay:FREQuency <value>

Applicable Models: E5080A, M9485A

(Read-Write) Sets group delay aperture using a fixed frequency range.

[See Critical Note](#)

Parameters

- <cnum> Channel number of the measurement. There must be a selected measurement on that channel. If unspecified, <cnum> is set to 1.
- <mnum> Measurement number for each measurement. There must be a selected measurement on the trace. If unspecified, <mnum> is set to 1.
- <value> Frequency range (in Hz) to use for the aperture setting. Choose between the equivalent of two data points and the channel frequency span.

Examples

```
CALC:GDEL:FREQ 1E6
```

Query Syntax CALCulate<cnum>:MEASure<mnum>:GDElay:FREQuency?

Return Type Numeric

Default Frequency range that equates to 11 points. This can be changed to two points with a preference setting.

CALCulate<cnum>:MEASure<mnum>:GDElay:PERCent <value>

Applicable Models: E5080A, M9485A

(Read-Write) Sets group delay aperture using a percent of the channel frequency span.

[See Critical Note](#)

Parameters

- <cnum> Channel number of the measurement. There must be a selected measurement on that channel. If unspecified, <cnum> is set to 1.
- <mnum> Measurement number for each measurement. There must be a selected measurement on the trace. If unspecified, <mnum> is set to 1.
- <value> Percent of frequency span to use for the aperture setting. Choose between the equivalent of two data points and 100 percent of the channel frequency span.

Examples

```
'set to 25 percent of the channel frequency span
CALC:GDEL:PERC 25
```

Query Syntax CALCulate<cnum>:MEASure<mnum>:GDElay:PERCent?

Return Type Numeric

Default Percent of frequency span that equates to 11 points. This can be changed to two points with a preference setting.

CALCulate<cnum>:MEASure<mnum>:GDElay:POINts <value>

Applicable Models: E5080A, M9485A

(Read-Write) Sets group delay aperture using a fixed number of data points.

[See Critical Note](#)

Parameters

- <cnum> Channel number of the measurement. There must be a selected measurement on that channel. If unspecified, <cnum> is set to 1.
- <mnum> Measurement number for each measurement. There must be a selected measurement on the trace. If unspecified, <mnum> is set to 1.
- <value> Number of data points to use for the aperture setting. Choose between two points and the number of points in the channel.

Examples

```
'set to 25 data points
CALC:MEAS:GDEL:POIN 25
```

E5080A

Query Syntax CALCulate<cnum>:MEASure<mnum>:GDElay:POINts?

Return Type Numeric

Default 11 points. This can be changed to two points with a preference setting.

Last modified:

29-Sep-2015 First Release

Calc:Limit Commands

Controls the limit segments used for Pass/Fail testing.

CALCulate:MEASure:LIMit:

DATA

| **DELeTe**

DISPlay

| **[STATe]**

FAIL?

SEGMent

| **AMPLitude**

| **START**

| **STOP**

| **STIMulus**

| **START**

| **STOP**

| **TYPE**

SOUNd

| **[STATe]**

REPort

| **ALL?**

| **[DATA]?**

| **POINts?**

[STATe]

CALCulate:MEASure:BLIMit:

DISPlay

| **MARKer**

| **STATE**

| **BWIDth**

| **THReshold**

FAIL

MAXimum

MINimum

REPort

| **DATA**

STATE

CALCulate:MEASure:RLIMit:

DATA

DISPlay

| **LINE**

| **STATE**

| RIPPle

| SElect

| TYPE

| STATE

FAIL

REPort:DATA

STATE

Click on a [Red](#) keyword to view the command details.

See Also

- [Example Programs](#)
- [Learn about Limit Lines](#)
- [Synchronizing the VNA and Controller](#)
- [SCPI Command Tree](#)

CALCulate<cnum>:MEASure<mnum>:LIMit:DATA <block>

Applicable Models: E5080A, M9485A

(Read-Write) Sets data for limit segments.

Parameters

<cnum> Channel number of the measurement for which limit lines are to be set. There must be a selected measurement on that channel. If unspecified, <cnum> is set to 1.

<mnum> Measurement number for each measurement. There must be a selected measurement on the trace. If unspecified, <mnum> is set to 1.

<block> Data for all limit segments in REAL,64 format. The following is the data format for 1 segment:

Type,BegStim, EndStim, BegResp,EndResp

Type Type of limit segment. Choose from
 0 - Off
 1 - Max
 2 - Min

BegStim Start of X-axis value (freq, power, time)

EndStim End of X-axis value

BegResp Y-axis value that corresponds with Start of X-axis value

EndResp Y-axis value that corresponds with End of X-axis value

Examples The following writes three max limit segments for a bandpass filter.

```
CALC:MEAS:LIM:DATA 1,3e5,4e9,-
60,0,1,4e9,7.5e9,0,0,1,7.5e9,9e9,0,-30
```

Query Syntax CALCulate<cnum>:MEASure<mnum>:LIMit:DATA?

Return Type Depends on [FORM:DATA](#) - All 100 predefined limit segments are returned.

Default 100 limit segments - all values set to 0

CALCulate<cnum>:MEASure<mnum>:LIMit:DATA:DELeTe

Applicable Models: E5080A, M9485A

(Write-only) Deletes all limit line data for the selected measurement on the specified channel.

Parameters

- <cnum> Channel number of the measurement. There must be a selected measurement on that channel. If unspecified, <cnum> is set to 1.
- <mnum> Measurement number for each measurement. There must be a selected measurement on the trace. If unspecified, <mnum> is set to 1.

Examples `CALC:MEAS:LIM:DATA:DEL`

Query Syntax Not Applicable

Default Not Applicable

CALCulate<cnum>:MEASure<mnum>:LIMit:DISPlay[:STATe] <bool>

Applicable Models: E5080A, M9485A

(Read-Write) Turns ON or OFF the display of limit segments (if the data trace is turned ON).

Parameters

- <cnum> Channel number of the measurement. There must be a selected measurement on that channel. If unspecified, <cnum> is set to 1.
- <mnum> Measurement number for each measurement. There must be a selected measurement on the trace. If unspecified, <mnum> is set to 1.
- <bool> Select limit segments from the following:
ON or 1 - Turns the display of limit segments ON.
OFF or 0 - Turns the display of limit segments OFF.

Examples `CALC:MEAS:LIM:DISP:STAT ON`
`calculate2:measure2:limit:display:state off`

Query Syntax `CALCulate<cnum>:MEASure<mnum>:LIMit:DISPlay[:STATe]?`

Return Type Boolean

Default OFF

CALCulate<cnum>:MEASure<mnum>:LIMit:FAIL?

Applicable Models: E5080A, M9485A

(Read-only) Reads the Pass/Fail status of the limit line test. Returns 1 (Fail) if any data point fails for any limit segment.

Limit display (CALC:MEAS:LIM:DISP) does NOT have to be ON.

Notes: When the limit test is set to OFF, False or OFF is always read out.

Parameters

- <cnm> Channel number of the measurement. There must be a selected measurement on that channel. If unspecified, <cnm> is set to 1.
- <mnum> Measurement number for each measurement. There must be a selected measurement on the trace. If unspecified, <mnum> is set to 1.

Examples `CALC:MEAS:LIM:FAIL?`

Return Type Boolean

- **0** is returned when **Pass**
- **1** is returned when **Fail**

Default Not Applicable

CALCulate<cnm>:MEASure<mnum>:LIMit:SEGment<snum>:AMPLitude:STARt <num>

Applicable Models: E5080A, M9485A

(Read-Write) Sets the start (beginning) of the Y-axis amplitude (response) value.

Parameters

- <cnm> Channel number of the measurement. There must be a selected measurement on that channel. If unspecified, <cnm> is set to 1.
- <mnum> Measurement number for each measurement. There must be a selected measurement on the trace. If unspecified, <mnum> is set to 1.
- <snum> Segment number; if unspecified, value is set to 1.
- <num> Choose any number between: **-500** and **500**.
Display value is limited to the Maximum and Minimum displayed Y-axis values.

Examples `CALC:MEAS:LIM:SEG1:AMPL:STAR 10`
`calculate2:measure2:limit:segment2:amplitude:start 10`

Query Syntax `CALCulate<cnm>:MEASure<mnum>:LIMit:SEGment<snum>AMPLitude:STARt?`

Return Type Numeric

Default 0

CALCulate<cnm>:MEASure<mnum>LIMit:SEGment<snum>:AMPLitude:STOP <num>

Applicable Models: E5080A, M9485A

(Read-Write) Sets the stop (end) of the Y-axis amplitude (response) value.

Parameters

- <cnm> Channel number of the measurement. There must be a selected measurement on that channel. If unspecified, <cnm> is set to 1.
- <mnum> Measurement number for each measurement. There must be a selected measurement on the trace. If unspecified, <mnum> is set to 1.
- <snum> Segment number; if unspecified, value is set to 1.
- <num> Choose any number between: **-500** and **500**.
Display value is limited to the Maximum and Minimum displayed Y-axis values.

Examples

```
CALC:MEAS:LIM:SEG1:AMPL:STOP 10
calculate2:measure2:limit:segment2:amplitude:stop 10
```

Query Syntax CALCulate<cnm>:MEASure<mnum>:LIMit:SEGment<snum>AMPLitude:STOP?

Return Type Numeric

Default 0

CALCulate<cnm>:MEASure<mnum>:LIMit:SEGment<snum>:STIMulus:STARt <num>

Applicable Models: E5080A, M9485A

(Read-Write) Sets the start (beginning) of the X-axis stimulus value.

Parameters

- <cnm> Channel number of the measurement. There must be a selected measurement on that channel. If unspecified, <cnm> is set to 1.
- <mnum> Measurement number for each measurement. There must be a selected measurement on the trace. If unspecified, <mnum> is set to 1.
- <snum> Segment number; if unspecified, value is set to 1.
- <num> Choose any number within the X-axis span of the analyzer.

Examples

```
CALC:MEAS:LIM:SEG1:STIM:STAR 10
calculate2:measure2:limit:segment2:stimulus:start 10
```

Query Syntax CALCulate<cnm>:MEASure<mnum>:LIMit:SEGment<snum>STIMulus:STARt?

Return Type Numeric

Default 0

CALCulate<cnum>:MEASure<mnum>:LIMit:SEGment<snum>:STIMulus:STOP <num>

Applicable Models: E5080A, M9485A

(Read-Write) Sets the stop (end) of the X-axis stimulus value.

Parameters

- <cnum> Channel number of the measurement. There must be a selected measurement on that channel. If unspecified, <cnum> is set to 1.
- <mnum> Measurement number for each measurement. There must be a selected measurement on the trace. If unspecified, <mnum> is set to 1.
- <snum> Segment number; if unspecified, value is set to 1.
- <num> Choose any number within the X-axis span of the analyzer.

Examples

```
CALC:MEAS:LIM:SEGM1:AMPL:STOP 10
calculate2:measure2:limit:segment2:stimulus:stop 10
```

Query Syntax CALCulate<cnum>:LIMit:SEGment<snum>STIMulus:STOP?

Return Type Numeric

Default 0

CALCulate<cnum>:MEASure<mnum>:LIMit:SEGment<snum>:TYPE|TYPe <char>

Applicable Models: E5080A, M9485A

(Read-Write) Sets the type of limit segment.

Parameters

- <cnum> Channel number of the measurement. There must be a selected measurement on that channel. If unspecified, <cnum> is set to 1.
- <mnum> Measurement number for each measurement. There must be a selected measurement on the trace. If unspecified, <mnum> is set to 1.
- <snum> Segment number. Choose any number between: **1** and **100**
If unspecified, value is set to 1.
- <char> Choose from:
LMAX - a MAX limit segment. Any response data exceeding the MAX value will fail.
LMIN - a MIN limit segment. Any response data below the MIN value will fail.
OFF - the limit segment (display and testing) is turned OFF.

Examples

```
CALC:MEAS:LIM:SEGM:TYPE LMIN
calculate2:measure2:limit:segment3:type lmax
```

Query Syntax CALCulate<cnum>:measure2:LIMit:SEGment<snum>:TYPE | TYPE ?

Return Type Character

Default OFF

CALCulate<cnum>:MEASure<mnum>:LIMit:SOUNd[:STATe] <bool>

Applicable Models: E5080A, M9485A

(Read-Write) Turns limit testing fail sound ON or OFF.

Parameters

- <cnum> Channel number of the measurement. There must be a selected measurement on that channel. If unspecified, <cnum> is set to 1.
- <mnum> Measurement number for each measurement. There must be a selected measurement on the trace. If unspecified, <mnum> is set to 1.
- <bool> **ON or 1** - Turns limit testing ON.
OFF or 0 - Turns limit testing OFF.

Examples `CALC:MEAS:LIM:SOUN ON`
`calculate2:measure2:limit:sound:state off`

Query Syntax CALCulate<cnum>:MEASure<mnum>:LIMit:SOUNd[:STATe]?

Return Type Boolean

Default OFF

CALCulate<cnum>:MEASure<mnum>:LIMit:REPort:ALL? <block>

Applicable Models: E5080A, M9485A

(Read-only) Reads the bandwidth test results (stimulus value, limit test result, upper limit value and lower limit value of all measurement points), for the active trace of selected channel.

Parameters

- <cnum> Channel number of the measurement. There must be a selected measurement on that channel. If unspecified, <cnum> is set to 1.
- <mnum> Measurement number for each measurement. There must be a selected measurement on the trace. If unspecified, <mnum> is set to 1.
- <block> Depends on [FORM:DATA](#)
If the number of the measurement points is N,
<Block> = <first stimulus>,<test result>,<upper limit>,<lower limit>, ..., <Nth

stimulus>,<test result>,<upper limit>,<lower limit>

Where <test result>= -1: No limit, 0:Fail, 1:Pass

Examples `CALC:MEAS:LIM:REP:ALL?`

Return Type Variant

Default Depend on the preset status

CALCulate<cnum>:MEASure<mnum>:LIMit:REPort[:DATA]? <block>

Applicable Models: E5080A, M9485A

(Read-only) Reads the stimulus values (frequency, power level or time) at all the measurement points that failed the limit test, for the active trace of selected channel.

Parameters

<cnum> Channel number of the measurement. There must be a selected measurement on that channel. If unspecified, <cnum> is set to 1.

<mnum> Measurement number for each measurement. There must be a selected measurement on the trace. If unspecified, <mnum> is set to 1.

<block> Depends on [FORM:DATA](#)

If the number of the measurement points that failed the limit test is N, <block>=<First failed stimulus>, ..., <Nth failed stimulus>.

Examples `CALC:MEAS:LIM:REP:DATA?`

Return Type Numeric

Default 9.91E37

CALCulate<cnum>:MEASure<mnum>:LIMit:REPort:POINts?

Applicable Models: E5080A, M9485A

(Read-only) Reads the number of the measurement points that failed the limit test, for the active trace of selected channel.

Parameters

<cnum> Channel number of the measurement. There must be a selected measurement on that channel. If unspecified, <cnum> is set to 1.

<mnum> Measurement number for each measurement. There must be a selected measurement on the trace. If unspecified, <mnum> is set to 1.

Examples `CALC:MEAS:LIM:REP:POIN?`

Query Syntax Numeric

Default 0

CALCulate<cnum>:MEASure<mnum>:LIMit[:STATe] <bool>

Applicable Models: E5080A, M9485A

(Read-Write) Turns limit segment **testing** ON or OFF.

- Use [CALC:LIM:DISP](#) to turn ON and OFF the **display** of limit segments.
- If using Global Pass/Fail status, trigger the VNA AFTER turning Limit testing ON.

Parameters

<cnum> Channel number of the measurement. There must be a selected measurement on that channel. If unspecified, <cnum> is set to 1.

<mnum> Measurement number for each measurement. There must be a selected measurement on the trace. If unspecified, <mnum> is set to 1.

<bool> **ON or 1** - Turns limit testing ON.
OFF or 0 - Turns limit testing OFF.

Examples `CALC:MEAS:LIM:STAT ON`
`calculate2:measure2:limit:state off`

Query Syntax `CALCulate<cnum>:MEASure<mnum>:LIMit:STATe?`

Return Type Boolean

Default OFF or 0

CALCulate<cnum>:MEASure<mnum>:BLIMit:DISPlay:MARKer:STATe <bool>

Applicable Models: E5080A, M9485A

(Read-Write) Turns ON/OFF the bandwidth value display of the bandwidth test, for the active trace of selected channel.

Parameters

<cnum> Channel number of the measurement. There must be a selected measurement on that channel. If unspecified, <cnum> is set to 1.

<bool> **ON or 1** - Turns limit testing ON.
OFF or 0 - Turns limit testing OFF.

Examples `CALC:BLIM:DISP:MARK:STAT ON`
`calculate2:measure2:blimit:display:marker:state off`

Query Syntax `CALCulate<cnum>:BLIMit:DISPLay:BWIDth:STATe?`

Return Type Boolean

Default OFF

CALCulate<cnum>:MEASure<mnum>:BLIMit:DISPLay:BWIDth:THReshold <value>

Applicable Models: E5080A, M9485A

(Read-Write) Sets bandwidth threshold value (attenuation from the peak) of the bandwidth test.

Parameters

<cnum> Channel number of the measurement. There must be a selected measurement on that channel. If unspecified, <cnum> is set to 1.

<value> Bandwidth N dB points

Examples `CALC:BLIM:DISP:BWID:THR 5`
`calculate2:measure2:blimit:display:bwid:threshold 5`

Query Syntax `CALCulate<cnum>:BLIMit:DISPLay:BWIDth:THReshold?`

Return Type Numeric

Default 3

CALCulate<cnum>:MEASure<mnum>:BLIMit:FAIL

Applicable Models: E5080A, M9485A

(Read-only) Get the bandwidth limit test results, for the active trace of selected channel.

Parameters

<cnum> Channel number of the measurement. There must be a selected measurement on that channel. If unspecified, <cnum> is set to 1.

<bool> Boolean

- **0** is returned when **Pass**
- **1** is returned when **Fail**

Examples

```
CALC:BLIM:FAIL?
calculate2:blimit:fail?
```

Query Syntax CALCulate<cnum>:BLIMit:FAIL?

Return Type Boolean

Default Not Applicable

CALCulate<cnum>:MEASure<mnum>:BLIMit:MAXimum <max>

Applicable Models: E5080A, M9485A

(Read-Write) Sets/gets the upper limit value of the bandwidth test, for the selected channel).

Parameters

<cnum> Channel number of the measurement. There must be a selected measurement on that channel. If unspecified, <cnum> is set to 1.

<max> Maximum bandwidth

Examples

```
CALC:BLIM:MAX 1E6
calculate2:blimit:maximum 1E6
```

Query Syntax CALCulate<cnum>:BLIMit:MAXimum?

Return Type Numeric

Default

CALCulate<cnum>:MEASure<mnum>:BLIMit:MINimum <min>

Applicable Models: E5080A, M9485A**(Read-Write)** Sets or returns the lower limit value of the bandwidth test, for the selected channel.**Parameters**

- <cnum> Channel number of the measurement. There must be a selected measurement on that channel. If unspecified, <cnum> is set to 1.
- <MinI> Minimum bandwidth

Examples `CALC:BLIM:MIN 1E6`
`calculate2:blimit:minimum 1E6`

Query Syntax CALCulate<cnum>:BLIMit:MINimum?**Return Type** Numeric**Default**

CALCulate<cnum>:MEASure<mnum>:BLIMit:REPort:DATA

Applicable Models: E5080A, M9485A**(Read-only)** Read the bandwidth value of the bandwidth test, for the active trace of selected channel.**Parameters**

- <cnum> Channel number of the measurement. There must be a selected measurement on that channel. If unspecified, <cnum> is set to 1.
- <data>>

Examples `CALC:BLIM:REP:DATA?`
`calculate2:blimit:report:data?`

Query Syntax CALCulate<cnum>:BLIMit:REPort:DATA?

Return Type Variant

Default OFF

CALCulate<cnum>:MEASure<mnum>:BLIMit:STATe

Applicable Models: E5080A, M9485A

(Read-Write) Turns ON/OFF the bandwidth test function, for the active trace of selected channel.

Parameters

<cnum> Channel number of the measurement. There must be a selected measurement on that channel. If unspecified, <cnum> is set to 1.

<bool> **ON or 1** - Turns limit testing ON.
OFF or 0 - Turns limit testing OFF.

Examples

```
CALC:MEAS:LIM:STAT ON
calculate2:measure2:limit:state off
```

Query Syntax CALCulate<cnum>:BLIMit:DIPLay:MARKer:STATe?

Return Type Boolean

Default OFF

CALCulate<cnum>:MEASure<mnum>:RLIMit:DATA <data>

Applicable Models: E5080A, M9485A

(Read-Write) Sets or returns the ripple limit table for the active trace of selected channel.

Parameters

<cnum> Channel number of the measurement. There must be a selected measurement on that channel. If unspecified, <cnum> is set to 1.

<data> Indicates the array data (for ripple line) of $1 + \text{Num}$ (number of limit lines)* 4. Where n is an integer between 1 and Num.

- Data(0) :The number of limit lines you want to set. Specify an integer ranging 0 to 12. When the number of limit lines is set to 0 (clears the limit table), the variable Data is only required with Data(0).
- Data(nx4-3) :The type of the n-th line.
Specify an integer 0 to 1 as follows.
0: OFF
1: ON
- Data(nx4-2) :The value on the horizontal axis (frequency/power/time) of the start point of the n-th line.
- Data(nx4-1) :The value on the horizontal axis (frequency/power/time) of the end point of the n-th line.
- Data(nx4) :The ripple line value (dB) of the n-th line.

The index of the array starts from 0.

Examples `CALC:RLIM:DATA`
`calculate2:rlimit:data`

Query Syntax `CALCulate<cnum>:MEASure<mnum>:RLIMit:DATA?`

Return Type Variant type Array

Default OFF

CALCulate<cnum>:MEASure<mnum>:RLIMit:DISPlay:LINE:STATe <bool>

Applicable Models: E5080A, M9485A

(Read-Write) Turns ON/OFF the ripple limit line display, for the active trace of selected channel.

Parameters

<cnum> Channel number of the measurement. There must be a selected measurement on that channel. If unspecified, <cnum> is set to 1.

<bool> **ON or 1** - Turns limit testing ON.
OFF or 0 - Turns limit testing OFF.

Examples `CALC:RLIM:DISP:LINE:STAT ON`
`calculate2:rlimit:display:line:state off`

Query Syntax CALCulate<cnum>:MEASure<mnum>:RLIMit:DISPLay:LINE:STATe?

Return Type Boolean

Default OFF

CALCulate<cnum>:MEASure<mnum>:RLIMit:DISPLay:SElect <band>

Applicable Models: E5080A, M9485A

(Read-Write) Sets or gets the ripple limit band for ripple value display for selected channel.

Parameters

<cnum> Channel number of the measurement. There must be a selected measurement on that channel. If unspecified, <cnum> is set to 1.

<band> 1 to 12

Examples

```
CALC:RLIM:DISP:RIPP:SEL
calculate2:rlimit:display:ripple:select
```

Query Syntax CALCulate<cnum>:MEASure<mnum>:RLIMit:DISPLay:SElect?

Return Type Numeric

Default 1

CALCulate<cnum>:MEASure<mnum>:RLIMit:DISPLay:TYPE <typ>

Applicable Models: E5080A, M9485A

(Read-Write) Sets/gets the display type of ripple value for the active trace of selected channel.

Parameters

<cnum> Channel number of the measurement. There must be a selected measurement on that channel. If unspecified, <cnum> is set to 1.

<typ> Select from the following:

- "OFF": Specifies the display OFF.
- "ABSolute": Specifies the absolute value for display type.
- "MARgin": Specifies the margin for display type.

Examples `CALC:RLIM:DISP:TYPE`
`calculate2:rlimit:display:type`

Query Syntax `CALCulate<cnum>:MEASure<mnum>:RLIMit:DISPLay:TYPE?`

Return Type Boolean

Default OFF

CALCulate<cnum>:MEASure<mnum>:RLIMit:DISPLay:STATe <bool>

Applicable Models: E5080A, M9485A

(Read-Write) Turns ON/OFF the ripple test function for the active trace of selected channel.

Parameters

<cnum> Channel number of the measurement. There must be a selected measurement on that channel. If unspecified, <cnum> is set to 1.

<bool> **ON or 1** - Turns limit testing ON.
OFF or 0 - Turns limit testing OFF.

Examples `CALC:RLIM:DISP:RIPP:STAT ON`
`calculate2:rlimit:display:ripple:state off`

Query Syntax `CALCulate<cnum>:RIMit:DISPLay:STATe?`

Return Type Boolean

Default OFF

CALCulate<cnum>:MEASure<mnum>:RLIMit:FAIL

Applicable Models: E5080A, M9485A

(Read-only) Read the ripple test result for the active trace.

Parameters

<cnum> Channel number of the measurement. There must be a selected measurement on that channel. If unspecified, <cnum> is set to 1.

<bool> Boolean

- **0** is returned when **Pass**
- **1** is returned when **Fail**

Examples

```
CALC:RLIM:FAIL?
calculate2:Rlimit:FAIL?
```

Query Syntax CALCulate<cnum>:MEASure<mnum>:RLIMit:FAIL?

Return Type Boolean

Default Not Applicable

CALCulate<cnum>:MEASure<mnum>:RLIMit:REPort:DATA

Applicable Models: E5080A, M9485A

(Read-only) Reads the ripple value of the ripple test for the active trace.

Parameters

<cnum> Channel number of the measurement. There must be a selected measurement on that channel. If unspecified, <cnum> is set to 1.

<data> {numeric 1} ... {numeric NOP×3+1}<newline><^END>

NOP is the number of measurement points.

- {numeric 1}: Number of ripple limit line
- {numeric n×3-1} : Number of ripple limit bands.
- {numeric n×3} : Ripple value.
- {numeric n×3+1} : Ripple test result (1: Fail, 0: Pass)

Examples `CALC:RLIM:REP:DATA?`
`calculate2:rlimit:report:data?`

Query Syntax `CALCulate<cnum>:MEASure<mnum>:RLIMit:REPort:DATA?`

Return Type Variant

Default OFF

CALCulate<cnum>:MEASure<mnum>:RLIMit:STATe <bool>

Applicable Models: E5080A, M9485A

(Read-Write) Turns ON/OFF the ripple test function for the active trace of selected channel.

Parameters

<cnum> Channel number of the measurement. There must be a selected measurement on that channel. If unspecified, <cnum> is set to 1.

<bool> **ON** (or 1) - turns limit testing ON.
OFF (or 0) - turns limit testing OFF.

Examples `CALC:RLIM:STAT ON`
`calculate2:rlimit:state off`

Query Syntax `CALCulate<cnum>:RLIMit:STATe?`

Return Type Boolean

Default OFF

Last modified:

29-Sep-2015 First Release

E5080A

Calculate:Marker Commands

Controls the marker settings used to remotely output specific data to the computer.

CALCulate:MEASure:MARKer:**AOFF****BUCKet****BWIDth**| [DATA?](#)| [\[STATe\]](#)| [THReshold](#)| [REF](#)**COMPression**| [LEVel](#)| [PIN?](#)| [POUT?](#)**COUPling**| [METHod](#)| [\[STATe\]](#)**DELTA****DISCrete****DISTance****FORMat****FUNcTion**| [APEak](#)| [EXCursion](#)| [THReshold](#)| [POLarity](#)| [PEAK](#)| [EXCursion](#)| [THReshold](#)| [DOMain](#)| [USER](#)| [\[RANGe\]](#)| [STARt](#)| [STOP](#)| [EXECute](#)| [MULTi](#)| [PEXCursion](#)| [PPOLarity](#)| [TARGet \[VALue\]](#)| [TRACking](#)

	TRansiton
	TYPE
	[SElect]
	TRACking
	TARGet [VALue]
	TRANsition
NOTch	
	DATA?
	[STATe]
	THReshold
	REF
PNOP more commands (separate topic)	
PSATuration more commands (separate topic)	
REFerence	
	[STATe]
	X
	Y
SET	
[STATe]	
TYPE	
X	
Y	

Click on a **Red** keyword to view the command details.

See Also

- Marker example program
- Marker Readout [number](#) and [size](#) commands.
- [Learn about Markers](#)
- [Synchronizing the VNA and Controller](#)
- [SCPI Command Tree](#)

Note: The Reference Marker is Marker Number 16

CALCulate<cnum>:MEASure<mnum>:MARKer:AOff

Applicable Models: E5080A, M9485A

(Write-only) Turns all markers off for selected measurement.

[See Critical Note](#)

Parameters

- <cnum> Channel number of the measurement. There must be a selected measurement on that channel. If unspecified, <cnum> is set to 1.
- <mnum> Measurement number for each measurement. There must be a selected measurement on the trace. If unspecified, <mnum> is set to 1.

Examples

```
CALC:MEAS:MARK:AOff
calculate2:measure2:marker:aoff
```

Query Syntax Not Applicable

Default Not Applicable

CALCulate<cnum>:MEASure<mnum>:MARKer<mkr>:BUCKet <num>

Applicable Models: E5080A, M9485A

(Read-Write) Sets and reads the data point (bucket) number of the trace on which the marker resides. When the markers are [interpolated \(non-discrete\)](#), the returned value is the nearest marker bucket position.

[See Critical Note](#)

Parameters

- <cnum> Channel number of the measurement. There must be a selected measurement on that channel. If unspecified, <cnum> is set to 1.
- <mkr> Marker number to move or query. The marker must already exist. If unspecified, <n> is set to 1.

<num> Data point (bucket) number. Choose any data point between: 0 and the number of data points minus 1.

Examples `CALC:MEAS:MARK::BUCK 5`
`calculate2:measure1:marker2:bucket 200`

Query Syntax `CALCulate<cnum>:MEASure<mnum>:MARKer<n>:BUCKet?`

Return Type Integer

Default The first marker is set to the middle of the span. Subsequent markers are set to the bucket number of the previously active marker.

CALCulate<cnum>:MEASure<mnum>:MARKer:BWIDth <num>

Applicable Models: E5080A, M9485A

(Read-Write) Turns on and sets markers 1 through 4 to calculate filter bandwidth. The <num> parameter sets the value below the maximum bandwidth peak that establishes the bandwidth of a filter. For example, if you want to determine the filter bandwidth 3 db below the bandpass peak value, set <num> to -3.

To turn off the Bandwidth markers, either turn them off individually or turn them [All Off](#).

The analyzer screen will show either Bandwidth statistics OR Trace statistics; not both.

To search a User Range with the bandwidth search, first activate marker 1 and set the desired [User Range](#). Then send the `CALC:MEAS:MARK:BWID` command. The user range used with bandwidth search only applies to marker 1 searching for the max value. The other markers may fall outside the user range.

[See Critical Note](#)

Parameters

<cnum> Channel number of the measurement. There must be a selected measurement on that channel. If unspecified, <cnum> is set to 1.

<num> Target value below filter peak. Choose any number between **-500** and **500**

Examples `CALC:MEAS:MARK:BWID -3`
`calculate2:measure1:marker:bwid -2.513`

Query Syntax `CALCulate<cnum>:MEASure<mnum>:MARKer:BWIDth?`
Returns the results of bandwidth search:

Return Type Numeric - Four Character values separated by commas: bandwidth, center Frequency, Q, loss.

Default -3

CALCulate<cnum>:MEASure<mnum>:MARKer<mkr>:BWIDth:DATA?

Applicable Models: E5080A, M9485A

(Read-only) Read the bandwidth search result of marker 1 to 15 and reference marker (Mkr:16), for the

active trace of selected channel.

If the bandwidth search is impossible, an error occurs when executed and the object is ignored.

[See Critical Note](#)

Parameters

<cnum> Channel number of the measurement. There must be a selected measurement on that channel. If unspecified, <cnum> is set to 1.

<mnum> Measurement number for each measurement. There must be a selected measurement on the trace. If unspecified, <mnum> is set to 1.

<mkr> Any marker number from 1 to 15; If unspecified, value is set to 1.

Four Character values separated by commas => {numeric 1}, {numeric 2}, {numeric 3}, {numeric 4}

- {numeric 1} : Bandwidth
- {numeric 2} : Center point frequency of the 2 cutoff frequency points
- {numeric 3} : Q value
- {numeric 4} : Insertion loss

Examples

```
CALC:MEAS:MARK:BWID:DATA?
calculate2:measure1:marker:bwid:data?
```

Query Syntax CALCulate<cnum>:MEASure<mnum>:MARKer<mkr>:BWIDth:DATA?

Return Type Numeric

Default Not Applicable

CALCulate<cnum>:MEASure<mnum>:MARKer<mkr>:BWIDth[:STATe] <bool>

Applicable Models: E5080A, M9485A

(Read-Write) Turns ON or OFF the bandwidth search result display, for the active trace of selected channel.

[See Critical Note](#)

Parameters

<cnum> Channel number of the measurement. There must be a selected measurement on that channel. If unspecified, <cnum> is set to 1.

<mnum> Measurement number for each measurement. There must be a selected measurement on the trace. If unspecified, <mnum> is set to 1.

<mkr> Any marker number from 1 to 15; if unspecified, value is set to 1.

<bool> Bandwidth search result display:

ON or 1 - Turns ON the bandwidth search result display.

OFF or 0 - Turns OFF the bandwidth search result display.

Examples `CALC:MEAS:MARK:BWID ON`
`calculate2:measure1:marker:bandwidth:state off`

Query Syntax `CALCulate<cnum>:MEASure<mnum>:MARKer:BWIDth[:STATe]?`

Return Type Boolean

Default OFF or 0

CALCulate<cnum>:MEASure<mnum>:MARKer<mkr>:BWIDth:THReshold <value><unit>

Applicable Models: E5080A, M9485A

(Read-Write) Sets or returns the bandwidth definition value (the value to define the pass-band of the filter) of marker 1 to 15 and reference marker (Mk:16), for the active trace of selected channel.

[See Critical Note](#)

Parameters

- <cnum> Channel number of the measurement. There must be a selected measurement on that channel. If unspecified, <cnum> is set to 1.
- <mnum> Measurement number for each measurement. There must be a selected measurement on the trace. If unspecified, <mnum> is set to 1.
- <mkr> Any marker number from 1 to 15; if unspecified, value is set to 1.
- <value> Bandwidth definition value (the value to define the pass band of the filter) is between -5E8 to 5E8.
- <unit> Varies depending on the data format.
 - Log magnitude (MLOG): dB (decibel)
 - Phase (PHAS), Expanded phase (UPH) or Positive phase (PPH): ° (degree)
 - Group delay (GDEL): s (second)
 - Others: No unit

Examples `CALC:MEAS:MARK:BWID:THR -3`
`calculate2:measure1:marker:bandwidth:threshold -3`

Query Syntax `CALCulate<cnum>:MEASure<mnum>:MARKer<mkr>:BWIDth:THReshold?`

Return Type Numeric

Default -3

CALCulate<cnum>:MEASure<mnum>:MARKer<mkr>:BWIDth:REF <string>

Applicable Models: E5080A, M9485A

(Read-Write) Set the bandwidth marker function reference to either MARKer or PEAK.

If the reference is set to MARKer, the active marker is not moved; the bandwidth search is computed at the marker;s current location.

If the reference is PEAK, the active marker is moved to the maximum or minimum peak on the trace and then bandwidth search is computed.

- If the bandwidth level is negative, the active marker is moved to the maximum peak.
- If the bandwidth level is positive, the active marker is moved to the minimum peak.

[See Critical Note](#)

Parameters

<cnum>	Channel number of the measurement. There must be a selected measurement on that channel. If unspecified, <cnum> is set to 1.
<mnum>	Measurement number for each measurement. There must be a selected measurement on the trace. If unspecified, <mnum> is set to 1.
<mkr>	Any marker number from 1 to 15; if unspecified, value is set to 1.
<string>	PEAK MARKer

Examples

```
CALC:MEAS:MARK:BWID:REF MARK
calculate2:measure1:marker:bwid:ref peak
```

Query Syntax CALCulate<cnum>:MEASure<mnum>:MARKer:BWIDth:REF?

Return Type String

Default MARKer

CALCulate<cnum>:MEASure<mnum>:MARKer<mkr>:COMPression:LEVel <num>

Applicable Models: E5080A, M9485A

(Read-Write) Sets and read the marker compression level. A compression marker must already exist. Use [CALC:MARK ON](#) and [CALC:MEAS:MARK:FUNC COMP](#) to create compression markers.

[See Critical Note](#)

Parameters

<cnum>	Channel number of the measurement. There must be a selected measurement on that channel. If unspecified, <cnum> is set to 1.
<mnum>	Measurement number for each measurement. There must be a selected measurement on the trace. If unspecified, <mnum> is set to 1.

<mkr> Any existing marker number from 1 to 15; if unspecified, value is set to 1.

<num> Compression level. Choose any number between: -500 dB to 500 dB
Standard gain compression values are positive.

Examples `CALC:MEAS:MARK:COMP:LEV 1`
`calculate2:measure1:marker:compression:level 1.5`

Query Syntax `CALCulate<cnum>:MEASure<mnum>:MARKer<mkr>:COMPression:LEVel?`

Return Type Numeric

Default +1 dB

CALCulate<cnum>:MEASure<mnum>:MARKer<mkr>:COMPression:PIN?

Applicable Models: E5080A, M9485A

(Read-only) Read the input power at the marker compression level. First send [CALC:MEAS:MARK:FUNC:EXEC COMP](#) or [CALC:MEAS:MARK:FUNC:TRAC ON](#)

[See Critical Note](#)

Parameters

<cnum> Channel number of the measurement. There must be a selected measurement on that channel. If unspecified, <cnum> is set to 1.

<mnum> Measurement number for each measurement. There must be a selected measurement on the trace. If unspecified, <mnum> is set to 1.

<mkr> Any existing marker number from 1 to 15; if unspecified, value is set to 1.

Examples `CALC:MEAS:MARK:COMP:PIN?`
`calculate2:measure1:marker:compression:pin?`

Return Type Numeric

Default Not Applicable

CALCulate<cnum>:MEASure<mnum>:MARKer<mkr>:COMPression:POUT?

Applicable Models: E5080A, M9485A

(Read-only) Read the output power at the marker compression level. First send [CALC:MEAS:MARK:FUNC:EXEC COMP](#) or [CALC:MEAS:MARK:FUNC:TRAC ON](#)

[See Critical Note](#)

Parameters

- <cnm> Channel number of the measurement. There must be a selected measurement on that channel. If unspecified, <cnm> is set to 1.
- <mnum> Measurement number for each measurement. There must be a selected measurement on the trace. If unspecified, <mnum> is set to 1.
- <mk> Any existing marker number from 1 to 15; if unspecified, value is set to 1.

Examples `CALC:MEAS:MARK:COMP:POUT?`
`calculate2:measure1:marker:compression:pout?`

Return Type Numeric

Default Not Applicable

CALCulate<cnm>:MEASure<mnum>:MARKer<mk>:COUPling[:STATe] <bool>

Applicable Models: E5080A, M9485A

(Read-Write) Turns ON or OFF the state of Coupled Markers.

[See Critical Note](#)

Parameters

- <cnm> Channel number of the measurement. There must be a selected measurement on that channel. If unspecified, <cnm> is set to 1.
- <mnum> Measurement number for each measurement. There must be a selected measurement on the trace. If unspecified, <mnum> is set to 1.
- <mk> Any existing marker number from 1 to 15; if unspecified, value is set to 1.
- <bool> **OFF or 0** - Turns Coupled Markers OFF.
ON or 1 - Turns Coupled Markers ON.

Examples `CALC:MEAS:MARK:COUP ON`
`calculate2:measure1:marker8:coupling:state off`

Query Syntax `CALCulate<cnm>:MEASure<mnum>:MARKer<mk>:COUPling[:STATe]?`

Return Type Boolean

Default OFF

CALCulate[:MEASure]:MARKer:COUPling:METhod <char>

Applicable Models: E5080A, M9485A

(Read-Write) Sets and reads the scope of Coupled Markers. This is a global setting that affects all markers. [Learn more.](#)

Note: This command will not take effect until Coupled Markers is turned on using [CALC:MARK:COUP:STATe ON.](#)

Note: The preset behavior of Coupled Markers depends on the setting of [SYSTem:PREFerences:ITEM:MCControl](#), [SYSTem:PREFerences:ITEM:MCMMethod](#), and [SYSTem:PREFerences:ITEM:MCPRest](#).

Parameters

<char> **CHANnel** - Coupling is limited to traces in the same channel.
ALL - Coupling occurs across all channels.

Examples `CALC:MARK:COUP:METH CHAN`
`calculate:marker:coupling all`

Query Syntax `CALCulate:MARKer:COUPling:METHod?`

Return Type Character

Default ALL

CALCulate<cnum>:MEASure<mnum>:MARKer<mkr>:DELTA <bool>

Applicable Models: E5080A, M9485A

(Read-Write) Specifies whether marker is relative to the Reference marker or absolute.

Note: The reference marker must already be turned ON with [CALC:MEAS:MARK:REF:STATE.](#)

[See Critical Note](#)

Parameters

<cnum> Channel number of the measurement. There must be a selected measurement on that channel. If unspecified, <cnum> is set to 1.

<mnum> Measurement number for each measurement. There must be a selected measurement on the trace. If unspecified, <mnum> is set to 1.

<mkr> Any existing marker number from 1 to 15; if unspecified, value is set to 1.

<bool> **ON or 1** - Specified marker is a Delta marker
OFF or 0 - Specified marker is an ABSOLUTE marker

Examples `CALC:MEAS:MARK:DELTA ON`
`calculate2:measure1:marker8:delta off`

Query Syntax `CALCulate<cnum>:MEASure<mnum>:MARKer<mkr>:DELTA?`

Return Type Boolean

Default OFF or 0

CALCulate<cnum>:MEASure<mnum>:MARKer<mkr>:DISCrete <bool>

Applicable Models: E5080A, M9485A

(Read-Write) Makes the specified marker display either a calculated value between data points (interpolated data) or the actual data points (discrete data).

[See Critical Note](#)

Parameters

- <cnum> Channel number of the measurement. There must be a selected measurement on that channel. If unspecified, <cnum> is set to 1.
- <mnum> Measurement number for each measurement. There must be a selected measurement on the trace. If unspecified, <mnum> is set to 1.
- <mkr> Any existing marker number from 1 to 15; if unspecified, value is set to 1.
- <bool> **ON or 1** - Specified marker displays the actual data points
OFF or 0 - Specified marker displays calculated data between the actual data points.

Examples

```
CALC:MEAS:MARK:DISC ON
calculate2:measure1:marker8:discrete off
```

Query Syntax CALCulate<cnum>:MEASure<mnum>:MARKer<mkr>:DISCrete?

Return Type Boolean

Default OFF or 0

CALCulate<cnum>:MEASure<mnum>:MARKer<mkr>:DISTance <num>

Applicable Models: E5080A, M9485A

(Read-Write) Sets or query marker distance on a time domain trace.

The Write command moves the marker to the specified distance value. Once moved, you can [read the Y axis](#) value or [read the X-axis time](#) value. (Distance is calculated from the X-axis time value.)

The Read command reads the distance of the marker.

If the marker is set as delta, the WRITE and READ data is relative to the reference marker.

[See Critical Note](#)

Parameters

- <cnum> Channel number of the measurement. There must be a selected measurement on that channel. If unspecified, <cnum> is set to 1.

<mnum> Measurement number for each measurement. There must be a selected measurement on the trace. If unspecified, <mnum> is set to 1.

<mkr> Any existing marker number from 1 to 15; if unspecified, value is set to 1.

<num> Marker distance in the unit of measure specified with [CALC:TRAN:TIME:MARK:UNIT](#)

Examples `CALC:MEAS:MARK:DIST .1`
`calculate2:measure1:marker8:distance 5`

Query Syntax `CALCulate<cnum>:MEASure<mnum>:MARKer<mkr>:DISTance?`

Return Type Numeric

Default Not Applicable

CALCulate<cnum>:MEASure<mnum>:MARKer<mkr>:FORMat <char>

Applicable Models: E5080A, M9485A

(Read-Write) Sets the format of the data that will be returned in a marker data query `CALC:MEAS:MARK:Y?` and the displayed value of the marker readout. The selection does not have to be the same as the measurement's display format.

[See Critical Note](#)

Parameters

<cnum> Channel number of the measurement. There must be a selected measurement on that channel. If unspecified, <cnum> is set to 1.

<mnum> Measurement number for each measurement. There must be a selected measurement on the trace. If unspecified, <mnum> is set to 1.

<mkr> Any marker number from 1 to 15; if unspecified, value is set to 1

<char> Choose from:

- **DEFault** - The format of the selected measurement
- **MLINear** - Linear magnitude
- **MLOGarithmic** - Logarithmic magnitude
- **IMPedance** - (R+jX)
- **ADMittance** - (G+jB)
- **PHASe** - Phase
- **IMAGinary** - Imaginary part (Im)
- **REAL** - Real part (Re)
- **POLar** - (Re, Im)
- **GDELay** - Group Delay

- **LINPhase** - Linear Magnitude and Phase
- **LOGPhase** - Log Magnitude and Phase
- **SWR** - Standing Wave Ratio

Examples `CALC:MEAS:MARK:FORMat MLIN`
`calculate2:measure1:marker8:format mlinear`

Query Syntax `CALCulate<cnum>:MEASure<mnum>:MARKer<mkr>:FORMat?`

Return Type Character

Default DEFault

CALCulate<cnum>:MARKer<mkr>:FUNCTION:APEak:EXCursion <num>

Applicable Models: E5080A, M9485A

(Read-Write) Sets amplitude peak excursion for the specified marker. The Excursion value determines what is considered a "peak". This command applies to marker peak searches (Next peak, Peak Right, Peak Left).

[See Critical Note](#)

Parameters

- <cnum> Channel number of the measurement. There must be a selected measurement on that channel. If unspecified, <cnum> is set to 1.
- <mkr> Any existing marker number from 1 to 10; if unspecified, value is set to 1.
- <num> Excursion value. Choose any number between **-500** and **500**.

Note: This command will accept **MIN** or **MAX** instead of a numeric parameter. See [SCPI Syntax](#) for more information.

Examples `CALC:MARK:FUNC:APE:EXC 10`
`calculate2:marker8:function:apeak:excursion maximum`

Query Syntax `CALCulate<cnum>:MARKer<mkr>:FUNCTION:APEak:EXCursion?`

Return Type Numeric

Default 3

CALCulate<cnum>:MEASure<mnum>:MARKer<mkr>:FUNCTION:APEak:POLarity <char>

Applicable Models: E5080A, M9485A

(Read-Write) Sets or returns polarity of the peak search with marker 1 to 15 and reference marker (Mk:16), for the active trace of selected channel.

[Learn more about Marker Search](#)

Parameters

- <cnum> Channel number of the measurement. There must be a selected measurement on that channel. If unspecified, <cnum> is set to 1.
- <mnum> Measurement number for each measurement. There must be a selected measurement on the trace. If unspecified, <mnum> is set to 1.
- <mkr> Any marker number from 1 to 15; if unspecified, value is set to 1.
- <char> Polarity for peak search function to be performed. Choose from:
 - **"NEGative"** : Specifies the negative peak.
 - **"POSitive"** : Specifies the positive peak.
 - **"BOTH"** : Specifies both the positive peak and the negative peak.

Examples `CALC:MEAS:MARK:FUNC:APE:POL NEG`
`calculate2:measure1:marker6:function:apeak:polarity both`

Query Syntax `CALCulate<cnum>:MEASure<mnum>:MARKer<mkr>:FUNCTION:APEak:POLarity?`

Return Type Character

Default "POSitive"

CALCulate<cnum>:MARKer<mkr>:FUNCTION:APEak:THReshold <num>

(Read-Write) Sets peak threshold for the specified marker. If a peak (using the criteria set with :EXCursion) is below this reference value, it will not be considered when searching for peaks. This command applies to marker peak searches (Next peak, Peak Right, Peak Left).

[See Critical Note](#)

Parameters

- <cnum> Channel number of the measurement. There must be a selected measurement on that channel. If unspecified, <cnum> is set to 1.
- <mkr> Any marker number from 1 to 15; if unspecified, value is set to 1
- <num> Threshold value. Choose any number between **-500** and **500**.

Note: This command will accept **MIN** or **MAX** instead of a numeric parameter. See [SCPI Syntax](#) for more information.

Examples `CALC:MARK:FUNC:APE:THR -40`
`calculate2:marker8:function:apeak:threshold -55`

Query Syntax CALCulate<cnum>:MARKer<mkr>:FUNction:APeak:THReshold?

Return Type Numeric

Default -100

CALCulate<cnum>:MEASure<mnum>:MARKer<mkr>:FUNction:PEAK:EXCursion <num><unit>

Applicable Models: E5080A, M9485A

(Read-Write) Sets amplitude peak excursion for the specified marker. The Excursion value determines what is considered a "peak". This command applies to marker peak searches (Next peak, Peak Right, Peak Left).

[See Critical Note](#)

Parameters

<cnum> Channel number of the measurement. There must be a selected measurement on that channel. If unspecified, <cnum> is set to 1.

<mnum> Measurement number for each measurement. There must be a selected measurement on the trace. If unspecified, <mnum> is set to 1.

<mkr> Any existing marker number from 1 to 15; if unspecified, value is set to 1.

<num> Excursion value. Choose any number between **-500** and **500**.

Notes: If the specified variable is out of the allowable setup range, the minimum value (if the lower limit of the range is not reached) or the maximum value (if the upper limit of the range is exceeded) is set.

This command will accept **MIN** or **MAX** instead of a numeric parameter. See [SCPI Syntax](#) for more information.

<unit> Varies depending on the data format.

- Log magnitude (MLOG): dB (decibel)
- Phase (PHAS), Expanded phase (UPH) or Positive phase (PPH): x (degree)
- Group delay (GDEL): s (second)
- Others: No unit

Examples

```
CALC:MEAS:MARK:FUNC:PEAK:EXC 10
calculate2:measure1:marker8:function:apeak:excursion maximum
```

Query Syntax CALCulate<cnum>:MEASure<mnum>:MARKer<mkr>:FUNction:PEAK:EXCursion?

Return Type Numeric

Default 3

CALCulate<cnum>:MEASure<mnum>:MARKer<mkr>:FUNCTion:PEAK:THReshold <num>**Applicable Models:** E5080A, M9485A

(Read-Write) Sets peak threshold for the specified marker. If a peak (using the criteria set with :EXCursion) is below this reference value, it will not be considered when searching for peaks. This command applies to marker peak searches (Next peak, Peak Right, Peak Left).

[See Critical Note](#)

Parameters

- <cnum> Channel number of the measurement. There must be a selected measurement on that channel. If unspecified, <cnum> is set to 1.
- <mnum> Measurement number for each measurement. There must be a selected measurement on the trace. If unspecified, <mnum> is set to 1.
- <mkr> Any marker number from 1 to 15; if unspecified, value is set to 1.
- <num> Threshold value. Choose any number between **-500** and **500**.

Note: This command will accept **MIN** or **MAX** instead of a numeric parameter. See [SCPI Syntax](#) for more information.

Examples

```
CALC:MEAS:MARK:FUNC:PEAK:THR -40
calculate2:measure1:marker8:function:peak:threshold -55
```

Query Syntax CALCulate<cnum>:MEASure<mnum>:MARKer<mkr>:FUNCTion:PEAK:THReshold?

Return Type Numeric

Default -100

CALCulate<cnum>:MEASure<mnum>:MARKer<mkr>:FUNCTion:DOMain:USER[:RANGe] <range>**Applicable Models:** E5080A, M9485A

(Read-Write) Assigns the specified marker to a range number. The x-axis travel of the marker is constrained to the range's span. The span is specified with the [CALC:MEAS:MARK:FUNC:DOM:USER:START](#) and [STOP](#) commands, unless range 0 is specified which is the full span of the analyzer.

Each channel has 16 user ranges. (Trace statistics use the same ranges.) More than one marker can use a domain range.

[See Critical Note](#)

Parameters

- <cnum> Channel number of the measurement. There must be a selected measurement on that channel. If unspecified, <cnum> is set to 1.
- <mnum> Measurement number for each measurement. There must be a selected measurement on the trace. If unspecified, <mnum> is set to 1.

- <mkr> Any marker number from 1 to 15; if unspecified, value is set to 1.
- <range> User span. Choose any Integer from 0 to 16.
0 is Full Span of the analyzer.
1 to 16 are available for user-defined x-axis span.

Examples

```
CALC:MEAS:MARK:FUNC:DOM:USER:RANG 1
calculate2:measure1:marker8:function:domain:user:range 1
```

Query Syntax

CALCulate<cnum>:MEASure<mnum>:MARKer<mkr>:FUNCTion:DOMain:USER:RANGe?

Return Type

Numeric

Default

0 - Full Span

CALCulate<cnum>:MEASure<mnum>:MARKer<mkr>:FUNCTion:DOMain:USER:START <start>

Applicable Models: E5080A, M9485A

(Read-Write) Sets the start of the span that the specified marker's x-axis span will be constrained to.

Use [CALC:MEAS:MARK:FUNC:DOM:USER<range>](#) to set range number.

Use [CALC:MEAS:MARK:FUNC:DOM:USER:STOP](#) to set the stop value.

Note: If the marker is assigned to range 0 (full span), the USER:START and STOP commands generate an error. You cannot set the START and STOP values for "Full Span".

Note: This command does the same as [CALC:FUNC:DOM:USER:STAR](#)

[See Critical Note](#)

Parameters

- <cnum> Channel number of the measurement. There must be a selected measurement on that channel. If unspecified, <cnum> is set to 1.
- <mnum> Measurement number for each measurement. There must be a selected measurement on the trace. If unspecified, <mnum> is set to 1.
- <mkr> Any marker number from 1 to 15; if unspecified, value is set to 1.
- <start> The analyzer's **Minimum** x-axis value

Examples

```
CALC:MEAS:MARK:FUNC:DOM:USER:START 500E6
calculate2:measure1:marker8:function:domain:user:start 1e12
```

Query Syntax

CALCulate<cnum>:MEASure<mnum>:MARKer<mkr>:FUNCTion:DOMain:USER:START?

Return Type

Numeric

Default The analyzer's **Minimum** x-axis value

CALCulate<cnum>:MEASure<mnum>:MARKer<mkr>:FUNCTION:DOMain:USER:STOP <stop>

Applicable Models: E5080A, M9485A

(Read-Write) Sets the stop of the span that the marker's x-axis travel will be constrained to.

Use [CALC:MEAS:MARK:FUNC:DOM:USER<range>](#) to set range number.

Use [CALC:MEAS:MARK:FUNC:DOM:USER:START](#) to set the stop value.

Note: If the marker is assigned to range 0 (full span), the USER:START and STOP commands generate an error. You cannot set the START and STOP values for "Full Span".

Note: This command does the same as [CALC:FUNC:DOM:USER:STOP](#)

[See Critical Note](#)

Parameters

- <cnum> Channel number of the measurement. There must be a selected measurement on that channel. If unspecified, <cnum> is set to 1.
- <mnum> Measurement number for each measurement. There must be a selected measurement on the trace. If unspecified, <mnum> is set to 1.
- <mkr> Any marker number from 1 to 15; if unspecified, value is set to 1.
- <stop> Stop value of x-axis span; Choose any number between the analyzer's **MINimum** and **MAXimum** x-axis value.

Examples

```
CALC:MEAS:MARK:FUNC:DOM:USER:STOP 500e6
calculate2:measure1:marker8:function:domain1:user:stop 1e12
```

Query Syntax CALCulate<cnum>:MEASure<mnum>:MARKer<mkr>:FUNCTION:DOMain:USER:STOP?

Return Type Numeric

Default The analyzer's **MAXimum** x-axis value.

CALCulate<cnum>:MEASure<mnum>:MARKer<mkr>:FUNCTION:EXECute <func>

Applicable Models: E5080A, M9485A

(Write-only) Immediately executes (performs) the specified search function.

[Learn more about Marker Search](#)

[See Critical Note](#)

Parameters

- <cnum> Channel number of the measurement. There must be a selected measurement on

that channel. If unspecified, <cnnum> is set to 1.

- <mnum> Measurement number for each measurement. There must be a selected measurement on the trace. If unspecified, <mnum> is set to 1.
- <mkr> Any marker number from 1 to 15; if unspecified, value is set to 1.
- <func> The function to be performed. Choose from:
- **MAXimum** - finds the highest value.
 - **MINimum** - finds the lowest value.
 - **RPEak** - finds the next valid peak to the right.
 - **LPEak** - finds the next valid peak to the left.
 - **NPEak** - finds the next highest value among the valid peaks.
 - **TARGet** - finds the target value to the right, wraps around to the left.
 - **LTARget** - finds the next target value to the left of the marker.
 - **RTARget** - finds the next target value to the right of the marker.
 - **COMPression** - finds the compression level on a Power Swept S21 trace.

Examples

```
CALC:MEAS:MARK:FUNC:EXEC MAX
calculate2:measure1:marker2:function:execute maximum
```

Query Syntax Not Applicable

Default Not Applicable

CALCulate<cnnum>:MEASure<mnum>:MARKer<mkr>:FUNCTion:MULTi:EXECute <func>

Applicable Models: E5080A, M9485A

(Write-only) Immediately executes (performs) the specified multi search function.

[Learn more about Marker Search](#)

[See Critical Note](#)

Parameters

- <cnnum> Channel number of the measurement. There must be a selected measurement on that channel. If unspecified, <cnnum> is set to 1.
- <mkr> Any marker number from 1 to 15; if unspecified, value is set to 1.
- <func> The function to be performed. Choose from:
- **TARGet** - finds the target value to the right, wraps around to the left.
 - **PEAK** - finds the next highest value among the valid peaks

Examples

```
CALC:MEAS:MARK:FUNC:EXEC MIN
calculate2:measure2:marker2:function:execute minimum
```

Query Syntax Not applicable

Default Not applicable

CALCulate<cnum>:MEASure<mnum>:MARKer<mkr>:FUNCTion:MULTi:PEXCursion <num><unit>

Applicable Models: E5080A, M9485A

(Read-Write) Sets or returns the lower limit of peak excursion value of multi peak search, for the selected channel and selected trace.

[Learn more about Marker Search](#)

Parameters

<cnum> Channel number of the measurement. There must be a selected measurement on that channel. If unspecified, <cnum> is set to 1.

<mnum> Measurement number for each measurement. There must be a selected measurement on the trace. If unspecified, <mnum> is set to 1.

<mkr> Any marker number from 1 to 15; if unspecified, value is set to 1.

<num> Excursion value. Choose any number between **-500** and **500**.

Notes: If the specified variable is out of the allowable setup range, the minimum value (if the lower limit of the range is not reached) or the maximum value (if the upper limit of the range is exceeded) is set.

This command will accept **MIN** or **MAX** instead of a numeric parameter. See [SCPI Syntax](#) for more information.

<unit> Varies depending on the data format.

- Log magnitude (MLOG): dB (decibel)
- Phase (PHAS), Expanded phase (UPH) or Positive phase (PPH): ° (degree)
- Group delay (GDEL): s (second)
- Others: No unit

Examples

```
CALC:MEAS:MARK:FUNC:MULT:PEXC 10
calculate2:measure2:marker8:function:multi:pexcursion maximum
```

Query Syntax CALCulate<cnum>:MEASure<mnum>:MARKer<mkr>:FUNCTion:MULTi:PEXCursion?

Return Type Numeric

Default 3

CALCulate<cnum>:MEASure<mnum>:MARKer<mkr>:FUNCTion:MULTi:PPOLarity <func>

Applicable Models: E5080A, M9485A

(Read-Write) Sets or returns the peak polarity of the multi peak search, for the selected channel and selected trace.

[Learn more about Marker Search](#)

Parameters

- <cnm> Channel number of the measurement. There must be a selected measurement on that channel. If unspecified, <cnm> is set to 1.
- <mnm> Measurement number for each measurement. There must be a selected measurement on the trace. If unspecified, <mnm> is set to 1.
- <mkr> Any marker number from 1 to 15; if unspecified, value is set to 1.
- <func> Polarity for multi peak search function to be performed. Choose from:
 - **"NEGative"** : Specifies the negative peak.
 - **"POSitive"** : Specifies the positive peak.
 - **"BOTH"** : Specifies both the positive peak and the negative peak.

Examples `CALC:MEAS:MARK:FUNC:MULT:PPOL NEG`
`calculate2:measure1:marker6:function:multi:ppolarity both`

Query Syntax `CALCulate<cnm>:MEASure<mnm>:MARKer<mkr>:FUNCTion:MULTi:POLarity?`

Return Type Character

Default "POSitive"

CALCulate<cnm>:MEASure<mnm>:MARKer<mkr>:FUNCTion:MULTi:SElect

Applicable Models: E5080A, M9485A

(Read-Write) Sets the search type of the multi search.

[Learn more about Marker Search](#)

Parameters

- <cnm> Channel number of the measurement. There must be a selected measurement on that channel. If unspecified, <cnm> is set to 1.
- <mnm> Measurement number for each measurement. There must be a selected measurement on the trace. If unspecified, <mnm> is set to 1.
- <mkr> Any marker number from 1 to 15; if unspecified, value is set to 1.
- <func> The function to be performed. Choose from:
 - OFF: Turn OFF the multi search function.
 - PEAK: Sets the search type to the multi peak search.

- **TARGet**: Sets the search type to the multi target search.

Examples `CALC:MEAS:MARK:FUNC:MULT:SEL PEAK`
`calculate2:measure1:marker6:function:multi:select peak`

Query Syntax `CALCulate<cnum>:MEASure<mnum>:MARKer<mkr>:FUNCTion:MULTi:SElect?`

Return Type Character

Default OFF

CALCulate<cnum>:MEASure<mnum>:MARKer<mkr>:FUNCTion:MULTi:TARGet[:VALue]
<num><unit>

Applicable Models: E5080A, M9485A

(Read-Write) Sets or returns the target value for the specified marker when doing Multi Target Search, for the selected channel and selected trace.

[Learn more about Marker Search](#)

Parameters

- <cnum>** Channel number of the measurement. There must be a selected measurement on that channel. If unspecified, <cnum> is set to 1.
- <mnum>** Measurement number for each measurement. There must be a selected measurement on the trace. If unspecified, <mnum> is set to 1.
- <mkr>** Any marker number from 1 to 15; if unspecified, value is set to 1.
- <num>** Target value for multi target search to search for.
The range of target value is -5E8 to 5E8.

Notes: If the specified variable is out of the allowable setup range, the minimum value (if the lower limit of the range is not reached) or the maximum value (if the upper limit of the range is exceeded) is set.

- <unit>** Varies depending on the data format.
 - Log magnitude (MLOG): dB (decibel)
 - Phase (PHAS), Expanded phase (UPH) or Positive phase (PPH): ° (degree)
 - Group delay (GDEL): s (second)
 - Others: No unit

Examples `CALC:MEAS:MARK:FUNC:MULT:TARG 2.5`
`calculate2:measure2:marker5:function:multi:target:value -10.3`

Query Syntax `CALCulate<cnum>:MEASure<mnum>:MARKer<mkr>:FUNCTion:MULTi:TARGet[:VALue]?`

Return Numeric

Type**Default** 0**CALCulate<cnum>:MEASure<mnum>:MARKer<mkr>:FUNCTion:MULTi:TRACking <bool>****Applicable Models:** E5080A, M9485A

(Read-Write) Turns ON or OFF the search tracking capability (function to repeat search for each sweep) of the multi search, for the selected channel and selected trace.

[Learn more about Marker Search](#)

Parameters

- <cnum> Channel number of the measurement. There must be a selected measurement on that channel. If unspecified, <cnum> is set to 1.
- <mnum> Measurement number for each measurement. There must be a selected measurement on the trace. If unspecified, <mnum> is set to 1.
- <mkr> Any marker number from 1 to 15; if unspecified, value is set to 1.
- <bool> **ON or 1** - Turns ON the marker search tracking. The specified multi marker will "Track" (find) the selected function every sweep.
OFF or 0 - Turns OFF the marker search tracking. The specified multi marker will find the selected function **only** when the CALC:MEAS:MARK:FUNC:EXECute command is sent.

Examples

```
CALC:MEAS:MARK:FUNC:MULT:TRAC ON
calculate2:measure2:marker8:function:multi:tracking off
```

Query Syntax CALCulate<cnum>:MEASure<mnum>:MARKer<mkr>:FUNCTion:MULTi:TRACking?**Return Type** Boolean**Default** OFF or 0**CALCulate<cnum>:MEASure<mnum>:MARKer<mkr>:FUNCTion:MULTi:TTRANsition <char>****Applicable Models:** E5080A, M9485A

(Read-Write) Sets the transition type of the multi target search.

[Learn more about Marker Search](#)

Parameters

- <cnum> Channel number of the measurement. There must be a selected measurement on that channel. If unspecified, <cnum> is set to 1.

- <mnum> Measurement number for each measurement. There must be a selected measurement on the trace. If unspecified, <mnum> is set to 1.
- <mkr> Any marker number from 1 to 15; if unspecified, value is set to 1.
- <char> Transition type of multi target search function to be performed. Choose from:
- **"NEGative"** : Specifies the negative transition.
 - **"POSitive"** : Specifies the positive transition.
 - **"BOTH"** : Specifies both the positive transition and the negative transition.

Examples

```
CALC:MEAS:MARK:FUNC:MULT:TRAN BOTH
calculate2:measure1:marker6:function:multi:transition both
```

Query Syntax CALCulate<cnum>:MEASure<mnum>:MARKer<mkr>:FUNCTion:MULTi:TTRansition?

Return Type Character

Default "BOTH"

CALCulate<cnum>:MEASure<mnum>:MARKer<mkr>:FUNCTion:MULTi:TYPE <char>

Applicable Models: E5080A, M9485A

(Read-Write) Sets or returns the search type of the multi search, for the selected channel and selected trace.

[Learn more about Marker Search](#)

Parameters

- <cnum> Channel number of the measurement. There must be a selected measurement on that channel. If unspecified, <cnum> is set to 1.
- <mnum> Measurement number for each measurement. There must be a selected measurement on the trace. If unspecified, <mnum> is set to 1.
- <mkr> Any marker number from 1 to 15; if unspecified, value is set to 1.
- <char> Select from the following:
- **"OFF"**: Turn OFF the multi search function.
 - **"PEAK"**: Sets the search type to the multi peak search.
 - **"TARGet"**: Sets the search type to the multi target search.

Examples

```
CALC:MEAS:MARK:FUNC:MULT:TRAN BOTH
calculate2:measure1:marker6:function:multi:transition both
```

Query Syntax CALCulate<cnum>:MEASure<mnum>:MARKer<mkr>:FUNCTion:MULTi:TTRansition?

Return Type Character

Default "OFF"

CALCulate<cnum>:MEASure<mnum>:MARKer<mkr>:FUNCTION[:SElect] <char>

Applicable Models: E5080A, M9485A

(Read-Write) Sets the search function that the specified marker will perform when executed. Use [CALC:MEAS:MARK:FUNC:TRAC ON](#) to automatically execute the search every sweep.

[Learn more about Marker Search](#)

[See Critical Note](#)

Parameters

- <cnum> Channel number of the measurement. There must be a selected measurement on that channel. If unspecified, <cnum> is set to 1.
- <mnum> Measurement number for each measurement. There must be a selected measurement on the trace. If unspecified, <mnum> is set to 1.
- <mkr> Any marker number from 1 to 15; if unspecified, value is set to 1.
- <char> Marker function. Choose from:
- **MAXimum** - finds the highest value
 - **MINimum** - finds the lowest value
 - **RPEak** - finds the next valid peak to the right
 - **LPEak** - finds the next valid peak to the left
 - **NPEak** - finds the next highest value among the valid peaks
 - **TARGet** - finds the target value to the right, wraps around to the left
 - **LTARget** - finds the next target value to the left of the marker
 - **RTARget** - finds the next target value to the right of the marker
 - **COMPression** - finds the compression level on a power-swept S21 trace.

Examples

```
CALC:MEAS:MARK:FUNC MAX
calculate2:measure1:marker8:function:select ltarget
```

Query Syntax CALCulate<cnum>:MEASure<mnum>:MARKer<mkr>:FUNCTION[:SElect]?

Return Type Character

Default MAXimum

CALCulate<cnum>:MEASure<mnum>:MARKer<mkr>:FUNCtion:TRACking <bool>

Applicable Models: E5080A, M9485A

(Read-Write) Turns ON or OFF the tracking search capability for the specified marker. The tracking function finds the selected search function every sweep. In effect, turning Tracking ON is the same as doing a [CALC:MEAS:MARK:FUNC:EXECute](#) command every sweep.

[Learn more about Marker Search](#)

[See Critical Note](#)

Parameters

- <cnum> Channel number of the measurement. There must be a selected measurement on that channel. If unspecified, <cnum> is set to 1.
- <mnum> Measurement number for each measurement. There must be a selected measurement on the trace. If unspecified, <mnum> is set to 1.
- <mkr> Any marker number from 1 to 15; if unspecified, value is set to 1.
- <bool> **ON or 1** - Turns ON the search tracking. The specified marker will "Track" (find) the selected function every sweep.
OFF or 0 - Turns OFF the search tracking. The specified marker will find the selected function **only** when the CALC:MEAS:MARK:FUNC:EXECute command is sent.

Examples

```
CALC:MEAS:MARK:FUNC:TRAC ON
calculate2:measure1:marker8:function:tracking off
```

Query Syntax CALCulate<cnum>:MEASure<mnum>:MARKer<mkr>:FUNCtion:TRACking?

Return Type Boolean

Default OFF or 0

CALCulate<cnum>:MEASure<mnum>:MARKer<mkr>:FUNCtion:TARGet[:VALue] <num>

Applicable Models: E5080A, M9485A

(Read-Write) Sets the target value for the specified marker when doing Target Searches with [CALC:MEAS:MARK:FUNC:SEL](#) <TARGet | RTARget | LTARget>

[See Critical Note](#)

Parameters

- <cnum> Channel number of the measurement. There must be a selected measurement on that channel. If unspecified, <cnum> is set to 1.

- <mnum> Measurement number for each measurement. There must be a selected measurement on the trace. If unspecified, <mnum> is set to 1.
- <mkr> Any marker number from 1 to 15; if unspecified, value is set to 1.
- <num> Target value to search for.
The range of value is between -5E8 to 5E8.
Notes: If the specified variable is out of the allowable setup range, the minimum value (if the lower limit of the range is not reached) or the maximum value (if the upper limit of the range is exceeded) is set.
- <unit> Varies depending on the data format.
- Log magnitude (MLOG): dB (decibel)
 - Phase (PHAS), Expanded phase (UPH) or Positive phase (PPH): ° (degree)
 - Group delay (GDEL): s (second)
 - Others: No unit

Examples `CALC:MEAS:MARK:FUNC:TARG 2.5`
`calculate2:measure1:marker8:function:target:value -10.3`

Query Syntax `CALCulate<cnum>:MEASure<mnum>:MARKer<mkr>:TARGet[:VALue]?`

Return Type Numeric

Default 0

CALCulate<cnum>:MEASure<mnum>:MARKer<mkr>:FUNCTion:TARGet[:VALue]:TRANSition <char>

Applicable Models: E5080A, M9485A

(Read-Write) Selects the transition type of the target search for specified marker (marker 1 to 15 and reference marker (Mk:16)) of the active trace of selected channel.

[See Critical Note](#)

Parameters

- <cnum> Channel number of the measurement. There must be a selected measurement on that channel. If unspecified, <cnum> is set to 1.
- <mnum> Measurement number for each measurement. There must be a selected measurement on the trace. If unspecified, <mnum> is set to 1.
- <mkr> Any marker number from 1 to 15; if unspecified, value is set to 1.
- <char> Transition type for search function to be performed. Choose from:
- **"NEGative"** : Specifies the negative transition.
 - **"POSitive"** : Specifies the positive transition.

- "BOTH" : Specifies both the positive transition and the negative transition.

Examples

```
CALC:MEAS:MARK:FUNC:TARG:TRAN POS
calculate2:measure1:marker8:function:target:value:transition both
```

Query Syntax

CALCulate<cnum>:MEASure<mnum>:MARKer<mkr>:FUNCtion:TARGet[:VALue]:TRANSition?

Return Type

Character

Default "BOTH"

CALCulate<cnum>:MEASure<mnum>:MARKer<mkr>:NOTCh:DATA?

Applicable Models: E5080A, M9485A

(Read-only) Reads the notch search result of marker 1 to 15 and reference marker (Mk:16), for the active trace of selected channel.

If the notch search is impossible, an error occurs and the command is ignored. In this case, no query response is obtained.

[See Critical Note](#)

Parameters

- <cnum> Channel number of the measurement. There must be a selected measurement on that channel. If unspecified, <cnum> is set to 1.
- <mnum> Measurement number for each measurement. There must be a selected measurement on the trace. If unspecified, <mnum> is set to 1.
- <mkr> Any marker number from 1 to 15; if unspecified, value is set to 1.

Indicates 4-element array data (notch bandwidth search result). Four Character values separated by commas => {Data 1}, {Data 2}, {Data 3}, {Data 4}

- Data(0) :The bandwidth.
- Data(1) :Center point frequency of the 2 cutoff frequency points.
- Data(2) :The Q value.
- Data(3) :Insertion loss

The index of the array starts from 0.

Examples

```
CALC:MEAS:MARK:NOTC:DATA?
calculate2:measure1:marker:notch:data?
```

Query Syntax

CALCulate<cnum>:MEASure<mnum>:MARKer<mkr>:NOTCh:DATA?

Return Type

Variant

Default Not Applicable

CALCulate<cnum>:MEASure<mnum>:MARKer<mkr>:NOTCh[:STATe] <bool>

Applicable Models: E5080A, M9485A

(Read-Write) Turns ON or OFF the notch search result display, for the active trace of selected channel.

[See Critical Note](#)

Parameters

- <cnum> Channel number of the measurement. There must be a selected measurement on that channel. If unspecified, <cnum> is set to 1.
- <mnum> Measurement number for each measurement. There must be a selected measurement on the trace. If unspecified, <mnum> is set to 1.
- <mkr> Any marker number from 1 to 15; if unspecified, value is set to 1.
- <bool> Notch search result display. Choose from:
ON or 1 - Turns ON the notch search result display.
OFF or 0 - Turns OFF the notch search result display.

Examples

```
CALC:MEAS:MARK:NOTC ON
calculate2:measure1:marker:notch:state off
```

Query Syntax CALCulate<cnum>:MEASure<mnum>:MARKer<mkr>:NOTCh[:STATe]?

Return Type Boolean

Default OFF or 0

CALCulate<cnum>:MEASure<mnum>:MARKer<mkr>:NOTCh:THReshold <num>

Applicable Models: E5080A, M9485A

(Read-Write) Sets or returns the notch definition value of marker 1 to 15 and reference marker (Mk:16), for the active trace of selected channel.

[See Critical Note](#)

Parameters

- <cnum> Channel number of the measurement. There must be a selected measurement on that channel. If unspecified, <cnum> is set to 1.
- <mnum> Measurement number for each measurement. There must be a selected measurement on the trace. If unspecified, <mnum> is set to 1.
- <mkr> Any marker number from 1 to 15; if unspecified, value is set to 1.

<num> The notch definition value range is between -5E8 to 5E8.

Notes: If the specified parameter is out of the allowable setup range, the minimum value (if the lower limit of the range is not reached) or the maximum value (if the upper limit of the range is exceeded) is set.

<unit> Varies depending on the data format as follows:

- Amplitude (MLOG):dB (decibel)
- Phase (PHAS), Expanded phase (UPH),Positive phase (PPH): ° (degree)
- Group delay (GDEL): s (second)
- Others: No unit

Examples

```
CALC:MEAS:MARK:NOTC:THR -3
calculate2:measure1:marker:notch:threshold -3
```

Query Syntax CALCulate<cnum>:MEASure<mnum>:MARKer<mkr>:NOTCh:THReshold?

Return Type Numeric

Default -3

CALCulate<cnum>:MEASure<mnum>:MARKer<mkr>:NOTCh:REF <string>

Applicable Models: E5080A, M9485A

(Read-Write) Set the notch marker reference to either MARKer or PEAK.

If the reference is set to MARKer, the active marker is not moved; the notch search is computed at the marker's current location.

If the reference is set to PEAK, the active marker is moved to the maximum or minimum peak on the trace and then notch search is computed.

- If the notch level is negative, the active marker is moved to the maximum peak.
- If the notch level is positive, the active marker is moved to minimum peak.

[See Critical Note](#)

Parameters

<cnum> Channel number of the measurement. There must be a selected measurement on that channel. If unspecified, <cnum> is set to 1.

<mnum> Measurement number for each measurement. There must be a selected measurement on the trace. If unspecified, <mnum> is set to 1.

<mkr> Any marker number from 1 to 15; if unspecified, value is set to 1.

<string> PEAK
MARKer

Examples

```
CALC:MEAS:MARK:NOTCh:REF
```

```
calculate2:measure1:marker:notch:ref
```

Query Syntax CALCulate<cnum>:MEASure<mnum>:MARKer<mkr>:NOTCh:REF?

Return Type String

Default MARKer

CALCulate<cnum>:MEASure<mnum>:MARKer<mkr>:REFerence[:STATe] <bool>

Applicable Models: E5080A, M9485A

(Read-Write) Turns ON or OFF the reference marker mode, for the active trace of selected channel. When turned OFF, existing Delta markers revert to absolute markers.

[See Critical Note](#)

Parameters

- <cnum> Channel number of the measurement. There must be a selected measurement on that channel. If unspecified, <cnum> is set to 1.
- <mnum> Measurement number for each measurement. There must be a selected measurement on the trace. If unspecified, <mnum> is set to 1.
- <mkr> Any marker number from 1 to 15; if unspecified, value is set to 1.
- <bool> **ON or 1** - Turns reference marker mode ON.
OFF or 0 - Turns reference marker mode OFF.

Examples

```
CALC:MEAS:MARK:REF ON
calculate2:measure1:marker:reference:state OFF
```

Query Syntax CALCulate<cnum>:MEASure<mnum>:MARKer<mkr>:REFerence[:STATe]?

Return Type Boolean

Default OFF or 0

CALCulate<cnum>:MEASure<mnum>:MARKer<mkr>:REFerence:X <num>

Applicable Models: E5080A, M9485A

(Read-Write) Sets and returns the absolute x-axis value of the reference marker.

[See Critical Note](#)

- <cnum> Channel number of the measurement. There must be a selected measurement on that channel. If unspecified, <cnum> is set to 1.
- <mnum> Measurement number for each measurement. There must be a selected measurement on the trace. If unspecified, <mnum> is set to 1.

- <mk> Any marker number from 1 to 15; if unspecified, value is set to 1.
- <num> X-axis value. Choose any number within the operating domain of the reference marker.

Examples `CALC:MEAS:MARK:REF:X 1e9`
`calculate2:measure1:marker:reference:x 1e6`

Query Syntax `CALCulate<cnum>:MEASure<mnum>:MARKer<mk>:REFerence:X?`

Return Type Numeric

Default If the first Marker, turns ON in the middle of the X-axis span. If not, turns ON at the position of the active marker.

CALCulate<cnum>:MEASure<mnum>:MARKer<mk>:REFerence:Y <num>

Applicable Models: E5080A, M9485A

(Read-Write) Sets and returns the absolute Y-axis value of the reference marker (Set the reference marker Y position only when the marker is a fixed marker type).

[See Critical Note](#)

Parameters

- <cnum> Channel number of the measurement. There must be a selected measurement on that channel. If unspecified, <cnum> is set to 1.
- <mnum> Measurement number for each measurement. There must be a selected measurement on the trace. If unspecified, <mnum> is set to 1.
- <mk> Any marker number from 1 to 15; if unspecified, value is set to 1.
- <num> Y-axis value. Choose any number within the operating domain of the reference marker.

Examples `CALC:MEAS:MARK:REF:Y 1e6`
`calculate2:measure1:marker:reference:y 1e9`

Return Type Numeric

Default Not Applicable

CALCulate<cnum>:MEASure<mnum>:MARKer<mk>:SET <char>

Applicable Models: E5080A, M9485A

(Write-only) Sets the selected instrument setting to assume the value of the specified marker.

Marker Functions CENT, SPAN, START, and STOP do not work with channels that are in [CW](#) or [Segment Sweep](#) mode.

[See Critical Note](#)

Parameters

- <cnm> Channel number of the measurement. There must be a selected measurement on that channel. If unspecified, <cnm> is set to 1.
- <mnm> Measurement number for each measurement. There must be a selected measurement on the trace. If unspecified, <mnm> is set to 1.
- <mkr> Any marker number from 1 to 15; if unspecified, value is set to 1
- <char> Choose from:
- **CENter** - changes center frequency to the value of the marker.
 - **SPAN** - changes the sweep span to the span that is defined by the delta marker and the marker that it references. Unavailable if there is no delta marker.
 - **START** - changes the start frequency to the value of the marker.
 - **STOP** - changes the stop frequency to the value of the marker.
 - **RLEVel** - changes the reference level to the value of the marker.
 - **DELay** - changes the line length at the receiver input to the phase slope at the active marker stimulus position.
 - **CWFReq** - Sets the CW frequency to the frequency of the active marker. Does NOT change sweep type. NOT available in CW or Power Sweep. Use this argument to first set the CW Frequency to a value that is known to be within the current calibrated range, THEN set [Sweep:Type](#) to POWER or CW.

Examples `CALC:MEAS:MARK:SET CENT`
`calculate2:measure1:marker8:set span`

Query Syntax Not Applicable

Default Not Applicable

CALCulate<cnm>:MEASure<mnm>:MARKer<mkr>[:STATe] <bool>

Applicable Models: E5080A, M9485A

(Read-Write) Turns ON or OFF the specified marker. **Marker 16 is the Reference Marker.** To turn all markers OFF, use [CALC:MEAS:MARK:AOFF](#).

[See Critical Note](#)

Parameters

- <cnm> Channel number of the measurement. There must be a selected measurement on

that channel. If unspecified, <cnun> is set to 1.

<mnum> Measurement number for each measurement. There must be a selected measurement on the trace. If unspecified, <mnum> is set to 1.

<mkr> Any marker number from 1 to 15; if unspecified, value is set to 1.

<bool> **ON or 1** - Turns marker ON.
OFF or 0 - Turns marker OFF.

Examples `CALC:MEAS:MARK ON`
`calculate2:measure1:marker8 off`

Query Syntax `CALCulate<cnun>:MEASure<mnum>:MARKer<mkr>:STATe?`

Return Type Boolean

Default OFF or 0

CALCulate<cnun>:MEASure<mnum>:MARKer<mkr>:TYPE <char>

Applicable Models: E5080A, M9485A

(Read-Write) Sets the type of the specified marker.

[See Critical Note](#)

Parameters

<cnun> Channel number of the measurement. There must be a selected measurement on that channel. If unspecified, <cnun> is set to 1.

<mnum> Measurement number for each measurement. There must be a selected measurement on the trace. If unspecified, <mnum> is set to 1.

<mkr> Any marker number from 1 to 15; if unspecified, value is set to 1

<char> Choose from:

- **NORMal** - a marker that stays on the assigned X-axis position unless moved or searching.
- **FIXed** - a marker that will not leave the assigned X or current Y-axis position.

Examples `CALC:MEAS:MARK:TYPE NORM`
`calculate2:measure1:marker2:type fixed`

Query Syntax `CALCulate<cnun>:MEASure<mnum>:MARKer<mkr>:TYPE?`

Return Type Character

Default NORMal

CALCulate<cnum>:MEASure<mnum>:MARKer<mkr>:X <num>

Applicable Models: E5080A, M9485A

(Read-Write) Sets the marker's X-axis value (frequency, power, or time). If the marker is set as delta, the SET and QUERY data is relative to the reference marker.

[See Critical Note](#)

Parameters

- <cnum> Channel number of the measurement. There must be a selected measurement on that channel. If unspecified, <cnum> is set to 1.
- <mnum> Measurement number for each measurement. There must be a selected measurement on the trace. If unspecified, <mnum> is set to 1.
- <mkr> Any marker number from 1 to 15; if unspecified, value is set to 1.
- <num> Any X-axis position within the measurement span of the marker.
(When the span value of the sweep range is 0, the range is from 0 to sweep time value.)
- Notes:** If the specified variable is out of the allowable setup range, the minimum value (if the lower limit of the range is not reached) or the maximum value (if the upper limit of the range is exceeded) is set.
- This command will accept **MIN** or **MAX** instead of a numeric parameter. See [SCPI Syntax](#) for more information.
- <unit> Hz (hertz), dBm or s (second)

Examples

```
CALC:MEAS:MARK:X 100Mhz
calculate2:measure1:marker8:x maximum
```

Query Syntax CALCulate<cnum>:MEASure<mnum>:MARKer<mkr>:X?

Return Type Numeric

Default First Marker turns ON in the middle of the X-axis span. Subsequent markers turn ON at the position of the active marker.

(When the span value of the sweep range is 0, the preset value is 0.)

CALCulate<cnum>:MEASure<mnum>:MARKer<mkr>:Y?

Applicable Models: E5080A, M9485A

(Read-only) Reads the marker's Y-axis value. The format of the value depends on the current [CALC:MEAS:MARK:FORMAT](#) setting. If the marker is set as delta, the data is relative to the reference marker. The query always returns two numbers:

- Smith and Polar formats - (Real, Imaginary)
- LINPhase and LOGPhase - (Real, Imaginary)

- All other formats - (Value,0)

Note: To accurately read the marker Y-axis value with [trace smoothing](#) applied, the requested format must match the [displayed format](#). Otherwise, the returned value is un-smoothed data. For example, to read the smoothed marker value when measuring group delay, both the display format and the marker format must be set to (Group) Delay.

[See Critical Note](#)

Parameters

- <cnum> Channel number of the measurement. There must be a selected measurement on that channel. If unspecified, <cnum> is set to 1.
- <mnum> Measurement number for each measurement. There must be a selected measurement on the trace. If unspecified, <mnum> is set to 1.
- <mkr> Any marker number from 1 to 15; if unspecified, value is set to 1.

Examples

```
CALC:MEAS:MARK:Y?
calculate2:measure1:marker3:y?
```

Query Syntax CALCulate<cnum>:MEASure<mnum>:MARKer<mkr>:Y?

Return Type Numeric

Default Not Applicable

Last modified:

29-Sep-2015 First Release



Calculate:Math Commands

Controls math operations on the currently selected measurement and memory.

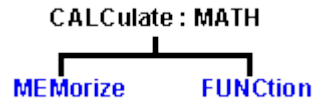

CALCulate:MEASure:MATH:

[FUNction](#)

[MEMorize](#)

CALCulate:MEASure:MIXer:

[XAXis](#) (seperate topic)

CALCulate:MEASure:OFFSet:

[MAGNitude](#) (seperate topic)

| [SLOPe](#) (seperate topic)

[PHASe](#) (seperate topic)

Click on a **Red** keyword to view the command details.

See Also

- Example Programs
- [Learn about Math Operations](#)
- [Synchronizing the VNA and Controller](#)
- [SCPI Command Tree](#)

Critical Note: CALCulate commands act on the selected measurement. You can select one measurement for each channel using [Calc:Par:MNUM](#) or [Calc:Par>Select](#). [Learn more](#).

CALCulate<cnum>:MEASure<mnum>:MATH:FUNction <char>

Applicable Models: E5080A, M9485A

(Read-Write) Sets math operations on the currently selected measurement and the trace stored in memory. (There **MUST** be a trace stored in Memory. See [CALC:MATH MEM](#))

[See Critical Note](#)

Parameters

<cnum> Channel number of the measurement. There must be a selected measurement on that channel. If unspecified, <cnum> is set to 1.

<mnum> Measurement number for each measurement. There must be a selected measurement on the trace. If unspecified, <mnum> is set to 1.

<char> The math operation to be applied. Choose from the following:

NORMal	Trace data only
ADD	Data + Memory
SUBTract	Data - Memory
MULTiPLY	Data * Memory
DIVide	Data / Memory

Examples `CALC:MATH:FUNC NORM`
`calculate2:measure2:math:function subtract`

Query Syntax `CALCulate<cnum>:MEASure<mnum>:MATH:FUNCtion?`

Return Type Character

Default NORMal

CALCulate<cnum>:MEASure<mnum>:MATH:MEMorize

Applicable Models: E5080A, M9485A

(Write-only) Puts the currently selected measurement trace into memory. (Data-> Memory).

[See Critical Note](#)

Parameters

<cnum>	Channel number of the measurement. There must be a selected measurement on that channel. If unspecified, <cnum> is set to 1.
<mnum>	Measurement number for each measurement. There must be a selected measurement on the trace. If unspecified, <mnum> is set to 1.

Examples `CALC:MEAS:MATH:MEM`

Query Syntax Not applicable

Default Not applicable

Last modified:

29-Sep-2015 First Release

Calculate:Mixer Command

CALCulate:MEASure:MIXer:

[XAXis](#)

Click on a [Red](#) keyword to view the command details.

CALCulate<cnum>:MEASure<mnum>:MIXer:XAXis <char>

Applicable Models: E5080A, M9485A

(Read-Write) Sets or returns the swept parameter to display on the X-axis for the selected FCA measurement.

Critical Note: CALCulate commands act on the selected measurement. You can select one measurement for each channel using [Calc:Par:MNUM](#) or [Calc:Par:Select](#). [Learn more](#).

Parameters

- <cnum> Channel number of the measurement. There must be a selected measurement on that channel. If unspecified, <cnum> is set to 1.
- <mnum> Measurement number for each measurement. There must be a selected measurement on the trace. If unspecified, <mnum> is set to 1.
- <char> Parameter to display on the X-axis. Choose from:
 - INPUT** - Input frequency span
 - OUTPUT** - Output frequency span
 - LO_1** - First LO frequency span
 - LO_2** - Second LO frequency span

Examples

```
CALC:MEAS:MIX:XAX INPUT
calc2:measure2:mixer:xaxis output

See an example that creates, selects, and calibrates an SMC
measurement using SCPI.
```

Query Syntax CALCulate<ch>:MEASure<mnum>:MIXer:XAXis?

Return Type Character

Default OUTPUT

Last modified:

29-Sep-2015 First Release

Calculate:Offset Commands

Allows the data trace magnitude and phase to be offset.

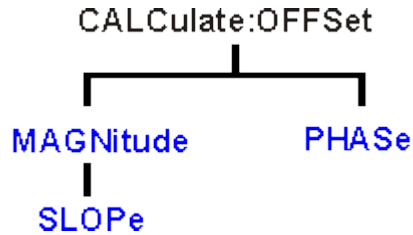

Click on a [Red](#) keyword to view the command details.

CALCulate:MEASure:OFFSet:

[MAGNitude](#)

| [SLOPe](#)

[PHASe](#)

See Also

- Example Programs
- [Learn about Magnitude Offset](#)
- [Learn about Phase Offset](#)
- [Synchronizing the VNA and Controller](#)
- [SCPI Command Tree](#)

Critical Note: CALCulate commands act on the selected measurement. You can select one measurement for each channel using [Calc:Par:MNUM](#) or [Calc:Par>Select](#). [Learn more](#).

CALCulate<cnum>:MEASure<mnum>:OFFSet:MAGNitude <num>

Applicable Models: E5080A, M9485A

(Read-Write) Offsets the data trace magnitude by the specified value.

To offset the data trace magnitude to a slope value that changes with frequency, use

[CALC:OFFS:MAGN:SLOP](#)

[See Critical Note](#)

Parameters

- <cnum> Channel number of the measurement. There must be a selected measurement on that channel. If unspecified, <cnum> is set to 1.
- <mnum> Measurement number for each measurement. There must be a selected measurement on the trace. If unspecified, <mnum> is set to 1.
- <num> Offset value in dB.

Examples `CALC:MEAS:OFFS:MAGN:4`
`calculat1:measure2:offset:magnitude -2`

Query Syntax `CALCulate<cnum>:MEASure<mnum>:OFFSet:MAGNitude?`

Return Type Numeric

Default 0

CALCulate<cnum>:MEASure<mnum>:OFFSet:MAGNitude:SLOPe <num>

Applicable Models: E5080A, M9485A

(Read-Write) Offsets the data trace magnitude to a value that changes linearly with frequency. The offset slope begins at 0 Hz.

[See Critical Note](#)

Parameters

- <cnum> Channel number of the measurement. There must be a selected measurement on that channel. If unspecified, <cnum> is set to 1.
- <mnum> Measurement number for each measurement. There must be a selected measurement on the trace. If unspecified, <mnum> is set to 1.
- <num> Offset slope value in dB/ 1GHz.

Examples `CALC:MEAS:OFFS:MAGN:SLOP 1 'Offset slope set to 1dB/GHz`
`calculat1:measure2:offset:magnitude:slope -2 'Offset slope`
`set to -2dB/GHz`

Query Syntax `CALCulate<cnum>:MEASure<mnum>:OFFSet:MAGNitude:SLOPe?`

Return Type Numeric

Default 0

CALCulate<cnum>:MEASure<mnum>:OFFSet:PHASe <num>[<char>]

Applicable Models: E5080A, M9485A

(Read-Write) Sets the phase offset for the selected measurement.

[See Critical Note](#)

Parameters

- <cnum> Channel number of the measurement. There must be a selected measurement on that channel. If unspecified, <cnum> is set to 1.
- <mnum> Measurement number for each measurement. There must be a selected

measurement on the trace. If unspecified, <mnum> is set to 1.

<num> Offset phase value. Choose any number between:
-360 and **360**

<char> Units for phase. OPTIONAL. Choose either:
DEG - Degrees (default)
RAD - Radians

Examples

```
CALC:MEAS:OFFS:PHAS 10  
calculate3:measure2:offset:phase 20rad
```

Query Syntax CALCulate<cnum>:MEASure<mnum>:OFFSet:PHASe?

Return Type Numeric, returned value always in degrees

Default 0 degrees

Last modified:

29-Sep-2015 First Release

Calculate:Parameter Commands

Lists, creates, selects, and deletes measurements.

CALCulate:PARAmeter:

CATalog
 | **EXTended**
COUNT

CALCulate:MEASure:

DEFine
PARAmeter
 MNUMber
 | [SElect]

Click on a **Red** keyword to view the command details.

See Also

- Example Programs
 - [Learn about Measurement Parameters](#)
 - [Synchronizing the VNA and Controller](#)
 - [SCPI Command Tree](#)
-

CALCulate<cnum>:PARAmeter:CATalog:EXTended?

Applicable Models: E5080A, M9485A

(Read-only) Returns the names and parameters of existing measurements for the specified channel. This command lists receiver parameters with "_" such that R1,1 is reported as R1_1. This makes the returned string a true "comma-delimited" list all the time.

The returned string of this command is easily parsed and used to create measurements using the [CALC:PAR:EXT](#) command.

Parameters

<cnum> Channel number of the measurements to be listed. There must be a selected measurement on that channel. If unspecified, <cnum> is set to 1.

Examples

```
CALC:PAR:CAT:EXT?
calculate2:parameter:catalog:extended?
```

Return Type

String - "<measurement name>,<parameter>,[<measurement name>,<parameter>...]"

Default "CH1_S11_1,S11"

CALCulate<cnum>:PARAmeter:COUNT <value>

Applicable Models: E5080A, M9485A

(Write-only) Sets or gets the number of traces of selected channel.

Parameters

- <cnum> Channel number of the measurements to be listed. There must be a selected measurement on that channel. If unspecified, <cnum> is set to 1.
- <value> Number of traces that should be present on the selected channel. Varies depending on the upper limit setting for the channel/trace number.

Note: This command will delete measurements if the specified value is less than the current value.

Examples CALC:PAR:COUNT 1

Query Syntax Numeric

Default 1

CALCulate<cnum>:MEASure<mnum>:DEFine <Mname>,<param>[,port]

Applicable Models: E5080A, M9485A

Note: This command is replaced with [CALC:PAR:DEFine:EXTended](#). This command will continue to work for up to 4-port parameters.

(Write-only) Creates a measurement parameter of the selected trace, for the selected channel but does NOT display it.

There is no limit to the number of measurements that can be created. However, there is a limit to the number of measurements that can be displayed. See [Traces, Channels, and Windows on the VNA](#).

- Use [DISP:WIND:STATE](#) to create a window if it doesn't already exist.
- Use [DISP:WIND:TRAC:FEED](#) to display the measurement.

You must select the measurement before making additional settings.

[See Critical Note](#)

Parameters

- <cnum> Channel number of the measurement to be listed. There must be a selected measurement on that channel. If unspecified, <cnum> is set to 1.
- <mnum> Measurement number for each measurement. There must be a selected measurement on the trace. If unspecified, <mnum> is set to 1.

<Mname> String - Name of the measurement parameter. Any non-empty, unique string, enclosed in quotes.

<param> **For S-parameters:**

Any S-parameter available in the VNA

For ratioed measurements:

Any two receivers that are available in the VNA.

For example: AR1 (this means A/R1)

For non-ratioed measurements:

Any receiver that is available in the VNA.

For example: A

Port No.	Test Receiver	Reference Receiver
1	A	R1
2	B	R2
3	C	R3
4	D	R4

For Balanced Measurements:

First create an S-parameter measurement, then change the measurement using CALC:FSIM:BAL commands.

[port] Optional argument;

For multi-port reflection S-parameter measurements: specifies the VNA port which will provide the load for the calibration. This argument is ignored if a transmission S-parameter is specified.

For all non S-parameter measurements: specifies the source port for the measurement.

Examples

```

CALC4:MEAS 'ch4_s33',s33,2 'Defines an S33 measurement with a
load on port2 of the analyzer'
calculate2:measure2:define 'ch1_a', a, 1 'unratioed meas'
calculate2:measure2:define 'ch1_a', ar1,1 'ratioed meas'
    
```

Query Syntax Not Applicable; see [Calc:Par:Cat?](#)

Default Not Applicable

CALCulate<cnum>:MEASure<mnum>:PARAmeter <string>

(Read-Write) To be extended to accept the balanced measurement parameters.

This extension will replace the following commands:

CALC:FSIM:BAL:PAR:SBAL[:DEF]

CALC:FSIM:BAL:PAR:SSB[:DEF]

CALC:FSIM:BAL:PAR:BBAL[:DEF]

CALC:FSIM:BAL:PAR:BALS[:DEF]

CALC:FSIM:BAL:PAR:BAL[:DEF]

[See Critical Note](#)

Parameters

- <num> Channel number of the measurements to be listed. There must be a selected measurement on that channel. If unspecified, <num> is set to 1.
- <mnum> Measurement number for each measurement. There must be a selected measurement on the trace. If unspecified, <mnum> is set to 1.
- <string> For 1 port balanced measurement, choose from:
Sdd11, Scd11, Sdc11, Scc11

For Balanced - Single-ended measurement, choose from:

Sdd11, Scd11, Sdc11, Scc11, Ssd21, Ssc21, Sds12, Scs12, Sss22, Imb, CMMR1, CMMR2

- $I_{mb} = - S_{1pos_2} / S_{1neg_2}$
- $CMMR1 = S_{sd21} / S_{sc21}$
- $CMMR2 = S_{ds12} / S_{cs12}$

For Single-ended - Balanced measurement, choose from:

Sss11, Sds21, Scs21, Ssd12, Ssc12, Sdd22, Scd22, Sdc22, Scc22, Imb, CMMR1, CMMR2

- $I_{mb} = - S_{2pos_1} / S_{2neg_1}$
- $CMMR1 = S_{ds21} / S_{cs21}$
- $CMMR2 = S_{sd12} / S_{sc12}$

For Balanced - Balanced measurement, choose from:

Sdd11, Sdd21, Sdd12, Sdd22, Scd11, Scd21, Scd12, Scd22, Sdc11, Sdc21, Sdc12, Sdc22,

Scc11, Scc21, Scc12, Scc22, Imb1, Imb2, CMMR

- $I_{mb1} = - (S_{1pos_2pos} - S_{1pos_2neg}) / (S_{1neg_2pos} - S_{1neg_2neg})$
- $I_{mb2} = - (S_{2pos_1pos} - S_{2pos_1neg}) / (S_{2neg_1pos} - S_{2neg_1neg})$
- $CMMR = - S_{dd21} / S_{cc21}$

For Single-ended - Single-ended - Balanced measurement, choose form:

Sss11, Sss21, Sss12, Sss22, Sds31, Scs31, Sds32, Scs32, Ssd13, Ssd23, Ssc13, Ssc23,

Sdd33, Scd33, Sdc33, Scc33, lmb1, lmb2, CMMR1, CMMR2

- $lmb1 = - (S_{1pos_2pos} - S_{1pos_2neg}) / (S_{1neg_2pos} - S_{1neg_2neg})$
- $lmb2 = - (S_{2pos_1pos} - S_{2pos_1neg}) / (S_{2neg_1pos} - S_{2neg_1neg})$
- $lmb3 = - S_{3pos_1} / S_{3neg_1}$
- $lmb4 = - S_{3pos_2} / S_{3neg_2}$
- $CMMR1 = Sds31 / Scs31$
- $CMMR2 = Sds32 / Scs32$

Note: The right definition for SSB imbalance is added as lmb3, 4. The definition for SSB lmb1, 2 seem a mistake, but keep it remained for backward compatibility.

Examples `CALC:MEAS:PAR "Sdd11"`
`calculate2:measure2:parameter "Sdd11"`

Query Syntax `CALCulate<cnum>:MEASure<mnum>:PARAmeter?`

Return Type String

Default "Sdd11"

CALCulate<cnum>:PARAmeter:MNUMBER[:SElect] <n>[,fast]

(Read-Write) Sets and returns the selected measurement for the channel using the **Tr#**. Most CALC: commands require that this, or [CALC:PAR:SEL](#), be sent before a setting change is made to that measurement. Each channel can have one selected measurement.

Parameters

- <cnum> Channel number of the measurement to be selected. If unspecified, <cnum> is set to 1.
- <n> Numeric - Measurement number. These are the same numbers you see in the "Tr1", "Tr2" annotation next to the parameter name on the VNA screen.
- [fast] Optional. The VNA display is NOT updated. Therefore, do not use this argument when an operator is using the VNA display. Otherwise, sending this argument results in much faster sweep speeds. There is NO other reason to NOT send this argument.

Examples `CALC:PAR:MNUM 2`
`calculate2:parameter:mnumber:select 3,fast`

Query Syntax `CALCulate<cnum>:PARAmeter:MNUMBER[:SElect]?`
 There is NO query available to determine if the FAST argument has been set.

Return Type Numeric

Default None

CALCulate<cnum>:PARAmeter:TAG:NEXT?

Applicable Models: E5080A, M9485A

(Read-only)

Parameters

<cnum> Channel number of the measurement. The selected measurement on that channel will be changed. If unspecified, <cnum> is set to 1.

Examples

CALC:PAR:TAG:NEXT

Query Syntax Not Applicable

Default Not Applicable

Last modified:

29-Sep-2015 First Release

Calculate:Smoothing Commands

Controls point-to-point smoothing. Smoothing is a noise reduction technique that averages adjacent data points in a measurement trace. Choose the amount of smoothing by specifying either the number of points or the aperture. Smoothing is not the same as CALC:AVERage which averages each data point over a number of sweeps.



CALCulate:MEASure:SMOothing:

[APERTure](#)

[POINTs](#)

[STATE](#)

Click on a [Red](#) keyword to view the command details.

See Also

- Example Programs
- [Learn about Smoothing](#)
- [Synchronizing the VNA and Controller](#)
- [SCPI Command Tree](#)

Critical Note: CALCulate commands act on the selected measurement. You can select one measurement for each channel using [Calc:Par:MNUM](#) or [Calc:Par:Select](#). [Learn more](#).

CALCulate<cnum>:MEASure<mnum>:SMOothing:APERTure <num>

Applicable Models: E5080A, M9485A

(Read-Write) Sets the amount of smoothing as a percentage of the number of data points in the channel.

[See Critical Note](#)

Parameters

- <cnum> Channel number of the measurement. There must be a selected measurement on that channel. If unspecified, <cnum> is set to 1.
- <mnum> Measurement number for each measurement. There must be a selected measurement on the trace. If unspecified, <mnum> is set to 1.
- <num> Percentage value. Choose any number between: **1** and **25**

Examples

```

CALC:MEAS:SMO:APER 2
calculate2:measure2:smoothing:aperture 20.7
  
```

Query Syntax CALCulate<cnum>:SMOothing:APERture?

Return Type Numeric

Default 1.5

CALCulate<cnum>:MEASure<mnum>:SMOothing:POINts <num>

Applicable Models: E5080A, M9485A

(Read-Write) Sets the number of adjacent data points to average.

[See Critical Note](#)

Parameters

- <cnum> Channel number of the measurement. There must be a selected measurement on that channel. If unspecified, <cnum> is set to 1.
- <mnum> Measurement number for each measurement. There must be a selected measurement on the trace. If unspecified, <mnum> is set to 1.
- <num> Number of points from 1 point to maximum of 25% of data points in the channel. For example: if number of points in a data trace = 401, the maximum value for points = 100. The points value is always rounded to the closest odd number.

Examples

```
CALC:MEAS:SMO:POIN 50
calculate2:measure2:smoothing:points 21
```

Query Syntax CALCulate<cnum>:MEASure<mnum>:SMOothing:POINts?

Return Type Numeric

Default 3

CALCulate<cnum>:MEASure<mnum>:SMOothing[:STATe] <bool>

Applicable Models: E5080A, M9485A

(Read-Write) Turns data smoothing ON or OFF.

[See Critical Note](#)

Parameters

- <cnum> Channel number of the measurement. There must be a selected measurement on that channel. If unspecified, <cnum> is set to 1.
- <mnum> Measurement number for each measurement. There must be a selected measurement on the trace. If unspecified, <mnum> is set to 1.
- <bool> **ON or 1** - Turns smoothing ON.

OFF or 0 - Turns smoothing OFF.

Examples

```
CALC:MEAS:SMO ON  
calculate2:measure2:smoothing:state off
```

Query Syntax

CALCulate<cnum>:MEASure<mnum>:SMOothing[:STATe]

Return Type

Boolean (1 = ON, 0 = OFF)

Default

OFF

Last modified:

29-Sep-2015 First Release



Calculate:Transform Commands

Specifies the settings for time domain transform.

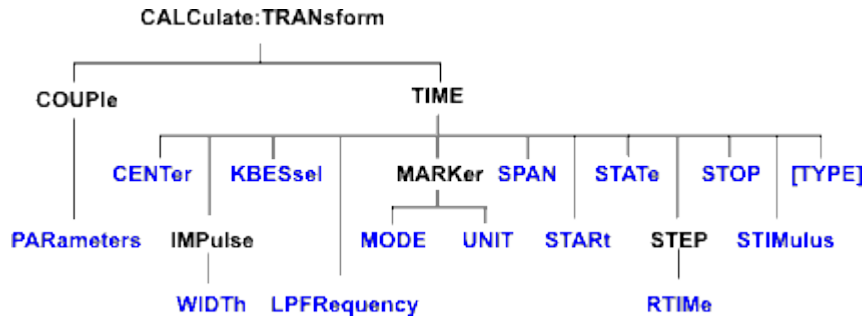

CALCulate:MEASure:TRANSform:

COUPLe

| [PARAmeters](#)

TIME

| [CENTer](#)

| IMPulse

| [WIDTH](#)

| [KBESsel](#)

| [LPFRequency](#) | [LPFREQuency](#)

| MARKer

| [MODE](#)

| [UNIT](#)

| [SPAN](#)

| [START](#)

| [STATE](#)

| STEP

| [RTIME](#)

| [STIMulus](#)

| [STOP](#)

| [\[TYPE\]](#)

Click on a [Red](#) keyword to view the command details.

See Also

- Example Programs
- Learn about Time Domain
- [Synchronizing the VNA and Controller](#)
- [SCPI Command Tree](#)

Critical Note: CALCulate commands act on the selected measurement. You can select one measurement for each channel using [Calc:Par:MNUM](#) or [Calc:Par:Select](#).

CALCulate<cnum>:MEASure<mnum>:TRANSform:COUPle:PARAmeters <num>

Applicable Models: E5080A, M9485A

(Read-Write) Specifies the time domain transform parameters to be coupled. The settings for those parameters will be copied from the selected measurement to all other measurements on the channel.

- To turn coupling ON and OFF, use [SENS:COUP:PAR](#)
- To specify Gating parameters to couple, use [CALC:FILT:COUP:PAR](#)

Learn more about Time Domain Trace Coupling

[See Critical Note](#)

Parameters

- <cnum> Channel number of the measurement. There must be a selected measurement on that channel. If unspecified, <cnum> is set to 1.
- <mnum> Measurement number for each measurement. There must be a selected measurement on the trace. If unspecified, <mnum> is set to 1.
- <num> (Numeric) Parameters to couple. To specify more than one parameter, add the numbers.
- 1 - Transform Stimulus (Start, Stop, Center, and Span TIME settings.)
 - 2 - Transform State (ON / OFF)
 - 4 - Transform Window (Kaiser Beta / Impulse Width)
 - 8 - Transform Mode (Low Pass Impulse, Low Pass Step, Band Pass)
 - 16 - Transform Distance Marker Units

Examples

```
'To couple all parameters:
CALC:MEAS:TRAN:COUP:PAR 31

'To couple Stimulus and Mode:
calculate2:measure2:transform:couple:parameters 9
```

Query Syntax CALCulate<cnum>:MEASure<mnum>:TRANSform:COUPle:PARAmeters?

Return Type Numeric

Default 29 (All parameters except 2 - Transform State)

CALCulate<cnum>:MEASure<mnum>:TRANSform:TIME:CENTer <num>

Applicable Models: E5080A, M9485A

(Read-Write) Sets the center time for time domain measurements.

[See Critical Note](#)**Parameters**

- <num> Channel number of the measurement. There must be a selected measurement on that channel. If unspecified, <num> is set to 1.
- <mnum> Measurement number for each measurement. There must be a selected measurement on the trace. If unspecified, <mnum> is set to 1.
- <num> Center time in seconds; any number between:
 $\pm (\text{number of points}-1) / \text{frequency span}$

Note: This command will accept **MIN** or **MAX** instead of a numeric parameter. See [SCPI Syntax](#) for more information.

Examples

```
CALC:MEAS:TRAN:TIME:CENT 1e-8
calculate2:measure2:transform:time:center 15 ps
```

Query Syntax CALCulate<num>:MEASure<mnum>:TRANSform:TIME:CENTer?

Return Type Numeric

Default 0

CALCulate<num>:MEASure<mnum>:TRANSform:TIME:IMPulse:WIDTh <num>

Applicable Models: E5080A, M9485A

(Read-Write) Sets the impulse width for the transform window.

[See Critical Note](#)**Parameters**

- <num> Channel number of the measurement. There must be a selected measurement on that channel. If unspecified, <num> is set to 1.
- <mnum> Measurement number for each measurement. There must be a selected measurement on the trace. If unspecified, <mnum> is set to 1.
- <num> Impulse width in seconds; Choose any number between:
.6 / frequency span and **1.39 / frequency span**

Examples

```
CALC:MEAS:TRAN:TIME:IMP:WIDTh 10
calculate2:measure2:transform:time:impulse:width 13
```

Query Syntax CALCulate<num>:MEASure<mnum>:TRANSform:TIME:IMPulse:WIDTh?

Return Type Numeric

Default .98 / Default Span

CALCulate<cnum>:MEASure<mnum>:TRANSform:TIME:KBESsel <num>

Applicable Models: E5080A, M9485A

(Read-Write) Sets the parametric window for the Kaiser Bessel window.

[See Critical Note](#)

Parameters

- <cnum> Channel number of the measurement. There must be a selected measurement on that channel. If unspecified, <cnum> is set to 1.
- <mnum> Measurement number for each measurement. There must be a selected measurement on the trace. If unspecified, <mnum> is set to 1.
- <num> Window width for Kaiser Bessel in seconds; Choose any number between: **0.0** and **13.0**

Examples

```
CALC:MEAS:TRAN:TIME:KBES 10
calculate2:measure2:transform:time:kbessel 13
```

Query Syntax CALCulate<cnum>:MEASure<mnum>:TRANSform:TIME:KBESsel?

Return Type Numeric

Default 6

CALCulate<cnum>:MEASure<mnum>:TRANSform:TIME:LPFREquency | LPFREquency

Applicable Models: E5080A, M9485A

(Write-only) Sets the start frequencies in LowPass Mode.

[See Critical Note](#)

Parameters

- <cnum> Channel number of the measurement. There must be a selected measurement on that channel. If unspecified, <cnum> is set to 1.
- <mnum> Measurement number for each measurement. There must be a selected measurement on the trace. If unspecified, <mnum> is set to 1.

Examples

```
CALC:MEAS:TRAN:TIME:LPFR
calculate2:measure2:transform:time:lpfrequency
```

Query Syntax Not Applicable

Default Not Applicable

CALCulate<cnum>:MEASure<mnum>:TRANSform:TIME:MARKer:MODE <char>

Applicable Models: E5080A, M9485A

(Read-Write) Specifies the measurement type in order to determine the correct marker distance.

- Select Auto for S-Parameter measurements.
- Select Reflection or Transmission for arbitrary ratio or unratiod measurements.

This setting affects the display of ALL markers for only the ACTIVE measurement.

Learn more about Distance Markers.

[See Critical Note](#)

Parameters

- <cnm> Channel number of the measurement. There must be a selected measurement on that channel. If unspecified, <cnm> is set to 1.
- <mnum> Measurement number for each measurement. There must be a selected measurement on the trace. If unspecified, <mnum> is set to 1.
- <char> Choose from:
- AUTO** - If the active measurement is an S-Parameter, automatically chooses reflection or transmission. If non S-Parameter measurements, reflection is chosen.
- REFlection** - Displays the distance from the source to the receiver divided by two (to compensate for the return trip.)
- TRANsmission** - Displays the distance from the source to the receiver.

Examples

```
CALC:MEAS:TRAN:TIME:MARK:MODE REFL
calculate2:measure2:transform:time:marker:mode auto
```

Query Syntax CALCulate<cnm>:MEASure<mnum>:TRANSform:TIME:MARKer:MODE?

Return Type Character

Default AUTO

CALCulate<cnm>:MEASure<mnum>:TRANSform:TIME:MARKer:UNIT <char>

Applicable Models: E5080A, M9485A

(Read-Write) Specifies the unit of measure for the display of marker distance values. This settings affects the display of ALL markers for only the ACTIVE measurement (unless Distance Maker Units are coupled using [CALC:TRAN:COUP:PAR](#)).

Learn more about Distance Markers.

[See Critical Note](#)

Parameters

- <cnm> Channel number of the measurement. There must be a selected measurement on that channel. If unspecified, <cnm> is set to 1.

<mnum> Measurement number for each measurement. There must be a selected measurement on the trace. If unspecified, <mnum> is set to 1.

<char> Choose from:

METRs

FEET

INCHes

Examples `CALC:MEAS:TRAN:TIME:MARK:UNIT INCH`
`calculate2:measure2:transform:time:marker:unit feet`

Query Syntax `CALCulate<cnum>:MEASure<mnum>:TRANSform:TIME:MARKer:UNIT?`

Return Type Character

Default METRs

CALCulate<cnum>:MEASure<mnum>:TRANSform:TIME:SPAN <num>

Applicable Models: E5080A, M9485A

(Read-Write) Sets the span time for time domain measurements.

[See Critical Note](#)

Parameters

<cnum> Channel number of the measurement. There must be a selected measurement on that channel. If unspecified, <cnum> is set to 1.

<mnum> Measurement number for each measurement. There must be a selected measurement on the trace. If unspecified, <mnum> is set to 1.

<num> Span time in seconds; any number between:
0 and $2^* [(number\ of\ points-1) / frequency\ span]$

Note: This command will accept **MIN** or **MAX** instead of a numeric parameter. See [SCPI Syntax](#) for more information.

Examples `CALC:MEAS:TRAN:TIME:SPAN 1e-8`
`calculate2:measure2:transform:time:span maximum`

Query Syntax `CALCulate<cnum>:MEASure<mnum>:TRANSform:TIME:SPAN?`

Return Type Numeric

Default 20 ns

CALCulate<cnum>:MEASure<mnum>:TRANSform:TIME:START <num>

Applicable Models: E5080A, M9485A

(Read-Write) Sets the start time for time domain measurements.

[See Critical Note](#)

Parameters

- <cnm> Channel number of the measurement. There must be a selected measurement on that channel. If unspecified, <cnm> is set to 1.
- <mnum> Measurement number for each measurement. There must be a selected measurement on the trace. If unspecified, <mnum> is set to 1.
- <num> Start time in seconds; any number between:
± (number of points-1) / frequency span

Note: This command will accept **MIN** or **MAX** instead of a numeric parameter. See [SCPI Syntax](#) for more information.

Examples

```
CALC:MEAS:TRAN:TIME:STAR 1e-8
calculate2:measure2:transform:time:start minimum
```

Query Syntax CALCulate<cnm>:MEASure<mnum>:TRANSform:TIME:STARt?

Return Type Numeric

Default -10 ns

CALCulate<cnm>:MEASure<mnum>:TRANSform:TIME:STATe <bool>

Applicable Models: E5080A, M9485A

(Read-Write) Turns the time domain transform capability ON or OFF.

[See Critical Note](#)

Note: [Sweep type](#) must be set to Linear Frequency in order to use Time Domain Transform.

Parameters

- <cnm> Channel number of the measurement. There must be a selected measurement on that channel. If unspecified, <cnm> is set to 1.
- <mnum> Measurement number for each measurement. There must be a selected measurement on the trace. If unspecified, <mnum> is set to 1.
- <bool> **ON** (or 1) - turns time domain ON.
OFF (or 0) - turns time domain OFF.

Examples

```
CALC:MEAS:TRAN:TIME:STAT ON
calculate2:measure2:transform:time:state off
```

Query Syntax CALCulate<cnm>:MEASure<mnum>:TRANSform:TIME:STATe?

Return Type Boolean (1 = ON, 0 = OFF)

Default OFF

CALCulate<cnum>:MEASure<mnum>:TRANSform:TIME:STEP:RTIME <num>

Applicable Models: E5080A, M9485A

(Read-Write) Sets the step rise time for the transform window.

[See Critical Note](#)

Parameters

- <cnum> Channel number of the measurement. There must be a selected measurement on that channel. If unspecified, <cnum> is set to 1.
- <mnum> Measurement number for each measurement. There must be a selected measurement on the trace. If unspecified, <mnum> is set to 1.
- <num> Rise time in seconds; Choose any number between:
.45 / frequency span and **1.48 / frequency span**

Examples

```
CALC:MEAS:TRAN:TIME:STEP:RTIM 1e-8
calculate2:measure2:transform:time:step:runtime 15 ps
```

Query Syntax CALCulate<cnum>:MEASure<mnum>:TRANSform:TIME:STEP:RTIME?

Return Type Numeric

Default .99 / Default Span

CALCulate<cnum>:MEASure<mnum>:TRANSform:TIME:STIMulus <char>

Applicable Models: E5080A, M9485A

(Read-Write) Sets the type of simulated stimulus that will be incident on the DUT.

[See Critical Note](#)

Parameters

- <cnum> Channel number of the measurement. There must be a selected measurement on that channel. If unspecified, <cnum> is set to 1.
- <mnum> Measurement number for each measurement. There must be a selected measurement on the trace. If unspecified, <mnum> is set to 1.
- <char> Choose from:
STEP - simulates a step DUT stimulus
IMPulse - simulates a pulse DUT stimulus

STEP can ONLY be used when `CALC:MEAS:TRAN:TIME:TYPE` is set to LPASs (Lowpass). (STEP **cannot** be used with TYPE = BPASs.)

:STIM STEP will set :TYPE to **LPASs**

:TYPE BPASs will set :STIM to **IMPulse**

Examples

```
CALC:MEAS:TRAN:TIME:STIM STEP
calculate2:measure2:transform:time:stimulus impulse
```

Query Syntax `CALCulate<cnum>:MEASure<mnum>:TRANSform:TIME:STIMulus?`

Return Type Character

Default IMPulse

CALCulate<cnum>:MEASure<mnum>:TRANSform:TIME:STOP <num>

Applicable Models: E5080A, M9485A

(Read-Write) Sets the stop time for time domain measurements.

[See Critical Note](#)

Parameters

- <cnum> Channel number of the measurement. There must be a selected measurement on that channel. If unspecified, <cnum> is set to 1.
- <mnum> Measurement number for each measurement. There must be a selected measurement on the trace. If unspecified, <mnum> is set to 1.
- <num> Stop time in seconds; any number between:
± (number of points-1) / frequency span

Note: This command will accept **MIN** or **MAX** instead of a numeric parameter. See [SCPI Syntax](#) for more information.

Examples

```
CALC:MEAS:TRAN:TIME:STOP 1e-8
calculate2:measure2:transform:time:stop maximum
```

Query Syntax `CALCulate<cnum>:MEASure<mnum>:TRANSform:TIME:STOP?`

Return Type Numeric

Default 10 ns

CALCulate<cnum>:MEASure<mnum>:TRANSform:TIME[:TYPE] <char>

Applicable Models: E5080A, M9485A

(Read-Write) Sets the type of time domain measurement.

[See Critical Note](#)

Parameters

- <cnum> Channel number of the measurement. There must be a selected measurement on that channel. If unspecified, <cnum> is set to 1.
- <mnum> Measurement number for each measurement. There must be a selected measurement on the trace. If unspecified, <mnum> is set to 1.
- <char> Type of measurement. Choose from:
LPASs - Lowpass; Must also send [CALC:MEAS:TRAN:TIME:LPFRequency](#) before calibrating.
BPASs - Bandpass;
 BPASs can **only** be used when [CALC:MEAS:TRAN:TIME:STIM](#) is set to IMPulse.
 (BPASs **cannot** be used with :STIM = STEP)
 :STIM **STEP** will set :TYPE to **LPASs**
 :TYPE **BPASs** will set :STIM to **IMPulse**

Examples

```
CALC:MEAS:TRAN:TIME LPAS
calculate2:measure2:transform:time:type bpas
```

Query Syntax CALCulate<cnum>:MEASure<mnum>:TRANSform:TIME[:TYPE]?

Return Type Character

Default BPAS

Last modified:

29-Sep-2015 First Release

Control Commands

Specifies the settings to remotely control the rear panel connectors, an external test set, and ECal Module state.

```

CONTRol
  CHANnel:INTerface:CONTRol
    | CONFig:RECall[STATe]
    | [STATe]
  ECAL:MODule
    | PATH
    | COUNT?
    | STATe
  HANDler - More Commands
  MULTiplexer
    | OUTPut
      | A|B|C|D|DATA
      | A|B|C|D:VOLTage|DATA

```

Click on a **Red** keyword to view the command details.

See Also

- Example Programs
- [Synchronizing the VNA and Controller](#)
- [SCPI Command Tree](#)
- See a pinout and detailed description of the rear panel connectors:
 - External Test Set IO connector
 - Material Handler IO connector

CONTRol:CHANnel:INTerface:CONTRol:CONFig:RECall[:STATe] <string>

Applicable Models: E5080A

(Write-only) Recalls an Interface Control configuration file. [Learn more about Interface Control.](#)

Parameters

<string> File name and extension (.xml) of the configuration file to recall. Files are typically stored in the default folder "D:\". To recall from a different folder, specify the full path name.

Examples

```
CONT:CHAN:INT:CONT:CONF:REC 'MyFile.xml'
control:channel:interface:control:config:recall:state
'D:\MyFile01.xml'
```

Query Syntax Not Applicable

Default Not Applicable

CONTROL:CHANnel:INTERface:CONTROL[:STATE] <bool>

Applicable Models: E5080A

(Read-Write) Enables and disables ALL Interface Control settings. To send data, the individual interfaces must also be enabled. [Learn more about Interface Control.](#)

Parameters

<bool> **OFF or 0** - Interface Control is disabled; NO control data is sent.
ON or 1 - Interface Control is enabled.

Examples

```
CONT:CHAN:INT:CONT 1
control:channel:interface:control:state 0
```

Query Syntax CONTROL:CHANnel:INTERface:CONTROL[:STATE]?

Return Type Boolean

Default OFF or 0

CONTROL:ECAL:MODule<num>:PATH:COUNT? <name>

Applicable Models: E5080A, M9485A

(Read-only) Returns the number of unique states that exist for the specified path name on the selected ECal module.

This command performs exactly the same function as [SENS:CORR:CKIT:ECAL:PATH:COUNT?](#)

Use the [CONT:ECAL:MOD:PATH:STAT](#) command to set the module into one of those states.

Use [SENS:CORR:CKIT:ECAL:PATH:DATA?](#) to read the data for a state.

Parameters

<num> Optional argument. USB number of the ECal module. If unspecified (only one ECal module is connected to the USB), <num> is set to 1. If two or more modules are connected, use [SENS:CORR:CKIT:ECAL:LIST?](#) to determine how many, and

[SENS:CORR:CKIT:ECAL:INF?](#) to verify their identities.

<name> Name of the path for which to read number of states. Choose from:

Reflection paths

- **A**
- **B**
- **C** (4-port modules)
- **D** (4-port modules)

Transmission paths

- **AB**
- **AC** (4-port modules)
- **AD** (4-port modules)
- **BC** (4-port modules)
- **BD** (4-port modules)
- **CD** (4-port modules)

Note: For each transmission path, the first of the available states is the through state, the second is the confidence (attenuator) state.

Examples

```
CONT:ECAL:MOD:PATH:COUNT? A
control:ecal:module2:path:count? cd
See example program
```

Return Type Integer

Default Not Applicable

CONTROL:ECAL:MODULE<num>:PATH:STATE <path>, <stateNum>

Applicable Models: E5080A, M9485A

(Write-only) Sets the internal state of the selected ECAL module. This command supersedes [CONT:ECAL:MOD:STAT](#).

- Use [CONT:ECAL:MOD:PATH:COUN?](#) to read the number of unique states that exist for the specified path name on the module.
- Use [SENS:CORR:CKIT:ECAL:PATH:DATA?](#) to read the data for a state (from the module memory) corresponding to the stimulus values of a channel.

Parameters

<num> Optional argument. USB number of the ECAL module. If unspecified (only one ECAL module is connected to the USB), <num> is set to 1. If two or more modules are connected, use [SENS:CORR:CKIT:ECAL:LIST?](#) to determine how many, and [SENS:CORR:CKIT:ECAL:INF?](#) to verify their identities.

<path> Path name for which to set a state.

Note: The impedance paths are not independent. For example, changing the impedance presented on path A will cause a change to the impedance on path B.

Choose from:

Reflection paths

- **A**
- **B**
- **C** (4-port modules)
- **D** (4-port modules)

Transmission paths

- **AB**
- **AC** (4-port modules)
- **AD** (4-port modules)
- **BC** (4-port modules)
- **BD** (4-port modules)
- **CD** (4-port modules)

<stateNum> Number of the state to set. Refer to the following table to associate the <stateNum> with a state in your ECal module.

In addition, [CONT:ECAL:MOD:PATH:COUNT?](#) returns the number of states in the specified ECal module.

<stateNum>	N4432A and N4433A States	N4431A States	N469x States**	8509x States
One-Port Reflection States				
1	Open	Open	Impedance 1	Open
2	Short	Short	Impedance 2	Short
3	Impedance 1	Impedance 1	Impedance 3	Impedance 1
4	Impedance 2	Impedance 2	Impedance 4	Impedance 2
5			Impedance 5	
6			Impedance 6	
7			Impedance 7	
Two-Port Transmission States				
1	Thru	Thru	Thru	Thru

2	Confidence	Confidence	Confidence	Confidence
---	------------	------------	------------	------------

** The following modules have only FOUR Impedance states (1, 2, 3, 4): N4690B ,N4691B ,N4692A ,N4696B.

Examples `CONT:ECAL:MOD:PATH:STATE A,5`
`control:ecal:module2:state BC,1`
 See example program

Query Syntax Not Applicable

Default Not Applicable

CONTROL:MULTiplexer<id>:OUTPut:<grp>[:DATA] <num>

Applicable Models: E5080A

(Read-Write) Sets or returns the output port data for specified group with id of the E5092A multiport test set.

Notes: This command is available only for E5092A multiport test set.

Parameters

<id> Id of the multiport test set either 1 or 2. If unspecified, Id is assumed to be 1.

<grp> A | B | C | D

<num> An integer specifying the decimal value of the control line. Values are obtained by adding weights from the following table that correspond to individual lines.

The output port data range is between 0 to 255 (0=All line are turns OFF and 255 all lines are turn ON).

Line	Weight
1	1
2	2
3	4
4	8
5	16
6	32
7	64

8	128
---	-----

Examples `CONT:MULT1:OUTP:B 8`

Query Syntax `CONTrol:MULTiplexer<id>:OUTPut:<grp>[:DATA]?`

Return Type Numeric

Default 0

`CONTrol:MULTiplexer<id>:OUTPut:<grp>VOLTage[:DATA] <volt>`

Applicable Models: E5080A

(Read-Write) Sets or returns the output voltage for specified group with id of the E5092A multiport test set.

Notes: This command is available only for E5092A multiport test set.

Parameters

<id> Id of the multiport test set either 1 or 2. If unspecified, Id is assumed to be 1.

<grp> A | B | C | D

<volt> Output voltage range for <grp> is between 0 to 5.2V and resolution is 10mV.

Examples `CONT:MULT1:OUTP:B:VOLT 4.2`

Query Syntax `CONTrol:MULTiplexer<id>:OUTPut:<grp>:VOLTage[:DATA]?`

E5080A

Return Type Numeric

Default 0 V

Last Modified:

29-Sep-2015 First Release



CSET:Fixture Commands

Manages several aspects of Cal Sets.

CSET:

| [CATalog?](#)

| [DALL](#)

| [DELeTe](#)

| [EXISts?](#)

| FIXTure:

| [DEEMbed](#)

| [EMBed](#)

Click on a [Red](#) keyword to view the command details.

Note: There is no user-interface equivalent for some of these commands.

See Also

- Example Programs
- [Synchronizing the VNA and Controller](#)
- [SCPI Command Tree](#)

CSET:CATalog?

Applicable Models: E5080A, M9485A

This command replaces [SENS:CORR:CSET:CAT?](#)

(Read-only) Returns the names of Cal Sets stored on the VNA.

Parameters None

Examples

```
CSET:CAT?
```

```
Returns:
```

```
"CalSet_0913,CalSet_1,CalSet_2,CalSet_3,CalSet_4,CH1_CALREG,CH31_CALREG,MyCalAll_SMC_002,MyCalAll_STD_001"
```

Return Type Comma-separated string of names

Default Not Applicable

CSET:DALL

Applicable Models: E5080A, M9485A

(Write-only) Deletes ALL Cal Sets from the VNA, including phase reference and Global Delta Match Cal Sets.

Parameters None

Examples `CSET:DALL`

Query Syntax Not Applicable

Default Not Applicable

[CSET:DEL <string>](#)

Applicable Models: E5080A, M9485A

This command replaces [SENS:CORR:CSET:DELeTe](#)

(Write-only) Deletes the specified Cal Set from the VNA.

- If the Cal Set is currently being used by a channel, the Cal Set is deleted and correction for the channel is turned off.
- If the Cal Set is not found, no error is returned.

Parameters

<string> Name of the Cal Set to delete. Not case-sensitive.

Examples `CSET:DEL "MyCalSet"`

Query Syntax Not Applicable

Default Not Applicable

[CSET:EXISts? <string>](#)

Applicable Models: E5080A, M9485A

(Read-only) Returns whether or not the specified Cal Set exists on the VNA.

Parameters

<string> Name or GUID of the Cal Set enclosed in quotes.
The GUID must also be enclosed in curly brackets.

Examples

```
dim check
check = CSET:EXISts? "MyCalSet"
check = CSET:EXISts? "{7C4EEA5E-40D2-4D70-A048-33BFFE704163}"
```

Return Type Boolean
ON or **1** - Cal Set exists.
OFF or **0** - Cal Set does NOT exist.

Default Not Applicable

CSET:FIXTure:DEEMbed <cs1>,<cs2>,<s2p>,<port>, <compPwr>[,<extrap>]

Applicable Models: E5080A, M9485A

(Write-only) De-embeds a fixture from an existing Cal Set based on an S2P file. A new Cal Set is created with the effects of the fixture removed.

When the new Cal Set is applied to a channel, the effects of fixturing are removed from the measurement data. Do NOT enable fixturing. The effects of the fixture are removed when the new Cal Set is selected and correction is turned ON.

Parameters

- <cs1> (String) Name of an existing Cal Set which resides on the VNA.
- <cs2> (String) Name of new Cal Set which contains updated error terms with fixture de-embedded.
- <s2p> (String) Name of the S2P file which characterizes the adapter/fixture.
- <port> (Numeric) Port number from which fixture will be de-embedded.
- <compPwr> (Boolean)
 - ON (1)** - When the Cal Set contains a power correction array for the fixture port, that array will be compensated for the fixture loss.
 - Warning: enabling power compensation can result in an increase in test port power and consequently, increased power to the DUT. Use with caution.
 - OFF (0)** - Do not compensate for loss in source power through the fixture.
- [extrap] (Boolean) Optional argument.
 - ON (1)** -Applies a simple extrapolation when the S2P file has a narrower frequency range than the Cal Set. The values for the first and last data points are extended in either direction to cover the frequency range of the Cal Set.
 - OFF (0)** - Extrapolation is NOT performed (default setting).

Examples

```
CSET:FIXT:DEEM "MyCalSet", "MyNewCalSet", "Fixture.s2p", 1, 1
cset:fixture:deembed
"MyCalSet", "MyNewCalSet", "Fixture.s2p", 1, 1, 1 'extrapolation is
performed if the s2p frequency range is narrower than that of
the Cal Set.
```

Query Syntax Not Applicable

Default Not Applicable

CSET:FIXTure:EMBed <cs1>,<cs2>,<s2p>,<port>, <compPwr>[,<extrap>]

Applicable Models: E5080A, M9485A

(Write-only) Embeds a fixture (usually a matching network) into an existing Cal Set based on an S2P file. A new Cal Set is created with the effects of the matching network included in the correction data.

When the new Cal Set is applied to a channel, the effects of the fixture are included in the measurement

data. Do NOT enable fixturing. The effects of the matching network are included when the new Cal Set is selected and correction is turned ON.

Parameters

- <cs1> (String) Name of an existing Cal Set which resides on the VNA.
- <cs2> (String) Name of new Cal Set which contains updated error terms with fixture embedded.
- <s2p> (String) Name of the S2P file which characterizes the fixture / matching network.
- <port> (Numeric) Port number to which fixture will be added.
- <compPwr> (Boolean)
- ON (1)** - Increase the source power to compensate for the loss through the fixture. The result is that the specified power level will be correct at the DUT input.
- Warning: enabling power compensation can result in an increase in test port power and consequently, increased power to the DUT. Use with caution.
- OFF (0)** - Do not compensate for loss in source power through the matching network.
- [extrap] (Boolean) Optional argument.
- ON (1)** -Applies a simple extrapolation when the S2P file has a narrower frequency range than the Cal Set. The values for the first and last data points are extended in either direction to cover the frequency range of the Cal Set.
- OFF (0)** - Extrapolation is NOT performed (default setting).

Examples

```
CSET:FIXT:EMB "MyCalSet","MyNewCalSet","Fixture.s2p",1,1
cset:fixture:embed
"MyCalSet","MyNewCalSet","Fixture.s2p",1,1,1 'extrapolation is
performed if the s2p frequency range is narrower than that of
the Cal Set.
```

Query Syntax Not Applicable

Default Not Applicable

Last Modified:

29-Sep-2015 First Release

Display Commands

Controls the settings of the front panel screen.

```

DISPlay:
  ANNotation
    | FREQuency[STATe]
    | MESSage:STATe
    | [STATus]
  ARRange
  CATalog?
  COLor More Commands
  ENABle
  FSIGn
  MEASure
    | DElete
    | Feed
    | MEMory
    | MOVE
    | SELect
    | [STATe]
    | TITle:DATA
    | TITle[STATe]
    | AUTO
    | PDIVision
    | RLEVel
    | RPOSition
  MEASurement
    | FEED
  SPLit
  STATus
    | LOG
    | CLEAr
  TMAX
  TILE
  TOOLbar
    | CSET[STATe]
    | ENTRy[STATe]
    | MARKer[STATe]
  UPDate
    | IMMediate
    | [STATe]
  VISible
  WINDow
    | ANNotation
    | MARKer
    | NUMBer

```

```

    | RESolution
      | RESPonse
      | STIMulus
    | SIZE
    | [STATe]
    | SYMBol
    | XPOSition
    | YPOSition
  | TRACe[STATe]
  | Y[STATe]
| CATalog?
| ENABle
| NEXT[NUMBER]?
| SIZE
| [STATe]
| TABLE
| TITLe
  | DATA
  | [STATe]
| TRACe
  | DELete
  GRATICule:GRID:LTYPe
  | TITLe
    | DATA
    | [STATe]
  | Y[SCALE]
    | COUPlE
      | METHod
      | [STATe]
| Y[SCALE]
| Y:AUTO

```

Click on a **Red** keyword to view the command details.

See Also

- [Referring to Traces Channels Windows and Meas Using SCPI](#)
- See an example using some of these commands
- [Synchronizing the VNA and Controller](#)
- [Learn about Screen Setup](#)
- [SCPI Command Tree](#)

DISPlay:ANNotation:FREQuency[:STATe] <bool>

Applicable Models: E5080A, M9485A

(Read-Write) Turns frequency information on the display title bar ON or OFF for all windows.

Parameters

<bool> **ON or 1** - Turns frequency annotation ON.
OFF or 0 - Turns frequency annotation OFF.

Examples `DISP:ANN:FREQ ON`
`display:annotation:frequency:state off`

Query Syntax `DISPlay:ANNotation:FREQuency[:STATe]?`

Return Type Boolean

Default ON or 1

[DISPlay:ANNotation:MESSage:STATe <bool>](#)

Applicable Models: E5080A, M9485A

(Read-Write) Enables and disables error pop-up messages on the display.

Parameters

<bool> **ON or 1** - Enables error pop-up messages
OFF or 0 - Disables error pop-up messages

Examples `DISP:ANN:MESS:STAT ON`
`display:annotation:message:state off`

Query Syntax `DISPlay:ANNotation:MESSage:STATe?`

Return Type Boolean

Default ON or 1

[DISPlay:ANNotation\[:STATus\] <bool>](#)

Applicable Models: E5080A, M9485A

(Read-Write) Turns the status bar at the bottom of the screen ON or OFF. The status bar displays information for the active window.

Parameters

<bool> **ON or 1** - Turns status bar ON.
OFF or 0 - Turns status bar OFF.

Examples `DISP:ANN ON`
`display:annotation:status off`

Query Syntax `DISPlay:ANNotation[:STATus]?`

Return Type Boolean

Default Last state that was set.

[DISPlay:ARRange <char>](#)

Applicable Models: E5080A, M9485A

(Write-only) Places EXISTING measurements into pre-configured window arrangements. Overlay, Stack(2), Split(3), and Quad(4) creates new windows.

Parameters

- <char> Window arrangement. Choose from:
- TILE - tiles existing windows
 - OVERlay - all traces placed in 1 window
 - STACK - 2 windows
 - SPLit - 3 windows
 - QUAD - 4 windows

Examples `DISP:ARR SPL`
`display:arrange overlay`

Query Syntax Not Applicable

Default TILE

[DISPlay:CATalog?](#)

Applicable Models: E5080A, M9485A

(Read-only) Returns the existing Window numbers.

To read the window number of the selected trace, use [Calc:Par:WNUM](#).

Return Type String of Character values, separated by commas

Example Two windows with numbers 1 and 2 returns:
`"1,2"`

Default Not Applicable

[DISPlay:ENABLE <bool>](#)

Applicable Models: E5080A, M9485A

(Read-Write) Specifies whether to disable or enable all analyzer display information **in all windows** in the analyzer application. Marker data is not updated. More CPU time is spent making measurements instead of updating the display.

Parameters

- <bool> **ON or 1** - Turns the display ON.
OFF or 0 - Turns the display OFF.

Examples `DISP:ENAB ON`
`display:enable off`

Query Syntax DISPlay:ENABLE?

Return Type Boolean

Default ON or 1

[DISPlay:FSIGn <bool>](#)

Applicable Models: E5080A, M9485A

(Read-Write) Shows or hides the window which displays global pass/fail results.

Parameters

<bool> **ON or 1** - Displays the pass/fail dialog
OFF or 0 - Hides the pass/fail dialog

Examples `DISP:FSIG ON`
`display:fsign off`

Query Syntax DISPlay:FSIGn?

Return Type Boolean

Default OFF or 0

[DISPlay:MEASure<mnum>:DELeTe](#)

Applicable Models: E5080A, M9485A

(Write-only) Deletes the trace associated with the specified measurement number.

Note: The measurement is not deleted. This command does the reverse of [DISP:MEAS:FEED](#).

Parameters

<mnum> Measurement number for each measurement. There must be a selected measurement on the trace. If unspecified, <mnum> is set to 1.

Examples `DISP:MEAS:DEL`
`display:measure2:delete`

Query Syntax DISPlay:MEASure<mnum>:DELeTe?

Return Type Not Applicable

Default Not Applicable

[DISPlay:MEASure<mnum>:FEED](#)

Applicable Models: E5080A, M9485A

(Write-only) This command creates a new trace in the specified window and connects the trace to measurement which results in the trace displaying the data from measurement.

Parameters

<mnum> Measurement number for each measurement. There must be a selected measurement on the trace. If unspecified, <mnum> is set to 1.

Examples `DISP:MEAS:FEED`
`display:measure:feed`

Query Syntax `DISPlay:MEASure:FEED?`

Return Type Not Applicable

Default Not Applicable

[DISPlay:MEASure<mnum>:MEMory\[:STATe\] <bool>](#)

Applicable Models: E5080A, M9485A

(Read-Write) Turns the memory trace ON or OFF for the specified measurement.

Note: [DISP:MEAS:FEED](#) must first be done to feed the measurement to a trace. This command behaves the same as [DISP:WIND:TRAC:MEM\[:STAT\]](#) except that it only requires the measurement number.

Parameters

<mnum> Measurement number for each measurement. There must be a selected measurement on the trace. If unspecified, <mnum> is set to 1.

<bool> **ON or 1** - Turns the memory trace ON.
OFF or 0 - Turns the memory trace OFF.

Examples `DISP:MEAS:MEM ON`
`display:measure:memory:state off`

Query Syntax `DISPlay:MEASure<mnum>:MEMory[:STATe]?`

Return Type Boolean

Default OFF

[DISPlay:MEASure<mnum>:MOVE <toWin>](#)

Applicable Models: E5080A, M9485A

(Write-only) Moves a trace associated with measurement number to the specified window. If the window is OFF, it will be turn ON.

Parameters

<mnum> Measurement number for each measurement. There must be a selected measurement on the trace. If unspecified, <mnum> is set to 1.

<toWin> Number of the window to which the specified measurement is moved. If the window does not exist, it will be created.

Examples `DISP:MEAS:MOVE 2`
`display:measure:move 1`

Query Syntax Not Applicable

Default Not Applicable

DISPlay:MEASure<mnum>:SElect

Applicable Models: E5080A, M9485A

(Write-only) Activates the specified measurement to be selected.

Parameters

<mnum> Measurement number for each measurement. There must be a selected measurement on the trace. If unspecified, <mnum> is set to 1.

Examples `DISP:MEAS:SEL`
`display:measure:select`

Query Syntax Not Applicable

Default Not Applicable

DISPlay:MEASure<mnum>[:STATe] <bool>

Applicable Models: E5080A, M9485A

(Read-Write) Turns ON or OFF the display of a trace associated with the specified measurement. When OFF, the measurement behind the trace is still active.

Note: A trace must first be created (via FEED), then the visibility of the trace can be affected with this command. If the trace has not been created, an error is generated: 107,Requested trace not found.

Parameters

<mnum> Measurement number for each measurement. There must be a selected measurement on the trace. If unspecified, <mnum> is set to 1.

<bool> **ON or 1** - Turns the trace ON.
OFF or 0 - Turns the trace OFF.

Examples `DISP:MEAS:STAT ON`
`display:measure off`

Query Syntax `DISPlay:MEASure<mnum>[:STATe]?`

Return Type Boolean

Default ON or 1

DISPlay:MEASure<mnum>:TITLE:DATA <string>

Applicable Models: E5080A, M9485A

(Read-Write) Sets or gets the title for the specified measurement. The trace title is embedded in the trace status field. [Learn more about Trace Titles.](#)

Newer entries replace (not append) older entries. The title is turned ON and OFF with

[DISP:WIND:TRAC:TITL:STAT.](#)**Parameters**

- <mnum> Measurement number for each measurement. There must be a selected measurement on the trace. If unspecified, <mnum> is set to 1.
- <string> Used as the title to be displayed for the measurement. Any characters (not spaces) enclosed with quotes.

Examples `DISP:MEAS:TITL:DATA 'MyNewMeas'`
`display:measure:title:data 'hello'`

Query Syntax `DISPlay:MEASure<mnum>:TITLe:DATA?`

Return Type String

Default Not Applicable

[DISPlay:MEASure<mnum>:TITLe\[:STATe\] <bool>](#)

Applicable Models: E5080A, M9485A

(Read-Write) Turns ON or OFF the measurement title.

Note: The measurement and trace need to exist. When turned OFF, the previous trace title returns. Set a new trace title using [DISP:WIND:TRAC:TITL:DATA](#)

[Learn more about Trace Titles](#)

Parameters

- <mnum> Measurement number for each measurement. There must be a selected measurement on the trace. If unspecified, <mnum> is set to 1.
- <bool> **ON or 1** - turns the title ON.
OFF or 0 - turns the title OFF.

Examples `DISP:MEAS:TITL ON`
`Display:measure:title:state off`

Query Syntax `DISPlay:MEAS<mnum>:TITLe[:STATe]?`

Return Type Boolean

Default OFF or 0

[DISPlay:MEASure<mnum>:Y\[:SCALE\]:AUTO](#)

Applicable Models: E5080A, M9485A

(Write-only) Performs an **Autoscale** on the specified trace in the specified measurement, providing the

best fit display.

Autoscale is performed only when the command is sent; it does NOT keep the trace autoscaled indefinitely.

Autoscale behaves differently when [scale coupling](#) is enabled. How it behaves depends on the scale coupling method. [Learn more.](#)

See Also, [DISPlay:WINDow:Y:AUTO](#) which performs an Autoscale All.

Parameters

<mnum> Measurement number for each measurement. There must be a selected measurement on the trace. If unspecified, <mnum> is set to 1.

Examples

```
DISP:MEAS:Y:AUTO
display:measure:y:scale:auto
```

Query Syntax Not Applicable

Default Not Applicable

[DISPlay:MEASure<mnum>:Y\[:SCALe\]:PDIVision <num>](#)

Applicable Models: E5080A, M9485A

(Read-Write) Sets the Y axis **Scale Per Division** value of the specified trace associated with the specified measurement.

Note: The measurement and trace need to exist.

Parameters

<mnum> Measurement number for each measurement. There must be a selected measurement on the trace. If unspecified, <mnum> is set to 1.

<num> Units / division value (Real value). The range of acceptable values is dependent on format and domain.

Note: This command will accept **MIN** or **MAX** instead of a numeric parameter. See [SCPI Syntax](#) for more information.

Examples

```
DISP:MEAS:Y:PDIV 1
display:measure:y:scale:pdivision maximum
```

Query Syntax DISPlay:MEASure<mnum>:Y[:SCALe]:PDIVision?

Return Type Numeric

Default 10

[DISPlay:MEASure<mnum>:Y\[:SCALe\]:RLEVel <num>](#)

Applicable Models: E5080A, M9485A

(Read-Write) Sets the Y axis **Reference Level** of the specified trace associated with the specified measurement.

Note: The measurement and trace need to exist.

Parameters

- <mnum> Measurement number for each measurement. There must be a selected measurement on the trace. If unspecified, <mnum> is set to 1.
- <num> Reference level value (Real value). The range of acceptable values is dependent on format and domain.

Note: This command will accept MIN or MAX instead of a numeric parameter. See [SCPI Syntax](#) for more information.

Examples

```
DISP:MEAS:Y:RLEV 0
display:measure:y:scale:rlevel minimum
```

Query Syntax DISPlay:MEASure<mnum>:Y[:SCALe]:RLEVel?

Return Type Numeric

Default 0

[DISPlay:MEASure<mnum>:Y\[:SCALe\]:RPOSition <num>](#)

Applicable Models: E5080A, M9485A

(Read-Write) Sets the **Reference Position** of the specified trace associated with the specified measurement.

Note: The measurement and trace need to exist.

Parameters

- <mnum> Measurement number for each measurement. There must be a selected measurement on the trace. If unspecified, <mnum> is set to 1.
- <num> Reference position on the screen measured in horizontal graticules from the bottom (Real value). The range of acceptable values is dependent on format and domain.

Note: This command will accept **MIN** or **MAX** instead of a numeric parameter. See [SCPI Syntax](#) for more information.

Examples

```
DISP:MEAS:Y:RPOS 0
display:measure:y:rposition maximum
```

Query Syntax DISPlay:MEASure<mnum>:Y[:SCALe]:RPOSition?

Return Type Numeric

Default 5

[DISPlay:SPLit <num>](#)

Applicable Models: E5080A, M9485A

(Write-only) Destroys all existing traces, channels and windows, then creates N windows. No channels are created.

Parameters

<num> N is 1 or greater.

Examples `DISP:SPL`
`display:split`

Query Syntax DISPlay:SPLit?

Return Type Numeric

Default Not Applicable

[DISPlay:STATus:LOG:CLEar](#)

Applicable Models: E5080A, M9485A

(Write-only) Clears the message region in the status bar.

Parameters

Examples `DISP:STAT:LOG:CLE`
`display:status:log:clear`

Query Syntax Not Applicable

Default Not Applicable

[DISPlay:TMAX <bool>](#)

Applicable Models: E5080A, M9485A

(Read-Write) Maximizes (isolates) or restores the active trace in the active window. When turned ON, the active trace is the ONLY trace on the display. All other traces are hidden. Learn more.

Parameters

<bool> **ON or 1** - Maximize/isolates the active trace.
OFF or 0 - Restores other traces to the normal window setting.

Examples `DISP:TMAX ON`
`display:tmax 0`

Query Syntax DISPlay:TMAX?

Return Type Boolean

Default OFF or 0

DISPlay[:TILE | TILE]This command is replaced by [DISP:ARR](#)**(Write-only)** Tiles the windows on the screen.**Examples** `DISP
display:tile`**Default** Not Applicable

DISPlay:TOOLbar:CSET[:STATe] <bool>**Applicable Models:** E5080A, M9485A**(Read-Write)** Displays the Cal Set Viewer in the GUI. [See this toolbar.](#)**Parameters**<bool> **ON or 1** - Toolbar ON.
OFF or 0 - Toolbar OFF.**Examples** `DISP:TOOL:CSET ON
display:toolbar:cset:state off`**Query Syntax** DISPlay:TOOLbar:CSET[:STATe]?**Return Type** Boolean**Default** OFF

DISPlay:TOOLbar:ENTRY[:STATe] <bool>**Applicable Models:** E5080A, M9485A**(Read-Write)** Specifies whether to show or hide the active entry toolbar. [See this toolbar.](#)**Parameters**<bool> **ON or 1** - Toolbar ON.
OFF or 0 - Toolbar OFF.**Examples** `DISP:TOOL:ENTR ON
display:toolbar:entry:state off`**Query Syntax** DISPlay:TOOLbar:ENTRY[:STATe]?**Return Type** Boolean**Default** ON

DISPlay:TOOLbar:MARKer[:STATe] <bool>**Applicable Models:** E5080A, M9485A

(Read-Write) Specifies whether to show or hide the marker toolbar. [See this toolbar.](#)

Parameters

<bool> **ON or 1** - Toolbar ON.
OFF or 0 - Toolbar OFF.

Examples `DISP:TOOL:MARK ON`
`display:toolbar:marker:state off`

Query Syntax `DISPlay:TOOLbar:MARKer[:STATe]?`

Return Type Boolean

Default ON

[DISPlay:UPDate:IMMediate](#)

Applicable Models: E5080A, M9485A

(Write-only) Executes the display update once when the display update of the LCD screen is set to OFF (specifying False with the [DISPlay:ENABLE](#) object).

Parameters

Examples `DISP:UPD:IMM`
`display:update:immediate`

Query Syntax Not Applicable

Return Type Not Applicable

Default Not Applicable

[DISPlay:UPDate\[:STATe\] <bool>](#)

Applicable Models: E5080A, M9485A

(Read-Write) Turns ON or OFF the display update.

Parameters

<bool> **ON or 1** - Update is turns ON.
OFF or 0 - Update is turns OFF.

Examples `DISP:UPD ON`
`display:update:state off`

Query Syntax `DISPlay:UPDate[:STATe]?`

Return Type Boolean

Default ON

DISPlay:VISible <bool>

Applicable Models: E5080A, M9485A

(**Read-Write**) Makes the VNA application visible or not visible. In the Not Visible state, the analyzer cycle time for making measurements, and especially data transfer, can be significantly faster because the display does not process data.

Parameters

<bool> **ON** (or 1) - VNA app is visible
OFF (or 0) - VNA app is NOT visible

Examples `DISP:VIS ON`
`display:visible off`

Query Syntax DISPlay:VISible?

Return Type Boolean

Default ON

DISPlay:WINDow<wnum>:ANNotation:LIMit:XPOSition <num>

Applicable Models: E5080A, M9485A

(**Read-Write**) Sets the horizontal (X-axis) position where the limit line pass/fail annotation will appear in the display window.

See other SCPI [Limit](#) commands. Learn more about [Marker readout](#).

Parameters

<wnum> Any existing window number. If unspecified, value is set to 1.

<num> X-axis position. Choose a value between 0 (far left) and 10 (far right).

Examples `DISP:WIND:ANN:LIM:XPOS 1.5`
`display>window:annotation:limit:xposition 5`

Query Syntax DISPlay:WINDow:ANNotation:LIMit:XPOSition?

Return Type Numeric

Default 7

DISPlay:WINDow<wnum>:ANNotation:LIMit:YPOSition <num>

Applicable Models: E5080A, M9485A

(**Read-Write**) Sets the vertical (Y-axis) position where the limit line pass/fail annotation will appear in the display window.

See other SCPI [Limit](#) commands. Learn more about [Marker readout](#).

Parameters

- <wnum> Any existing window number. If unspecified, value is set to 1.
- <num> Y-axis position. Choose a value between 0 (far left) and 10 (far right).

Examples

```
DISP:WIND:ANN:LIM:YPOS 1.5
display>window:annotation:limit:yposition 5
```

Query Syntax DISPlay:WINDow:ANNotation:LIMit:YPOSition?

Return Type Numeric

Default 0

[DISPlay:WINDow<wnum>:ANNotation:MARKer:NUMBer <num>](#)

Applicable Models: E5080A, M9485A

This command replaces [DISP:WIND:ANN:MARK:SING](#)

(Read-Write) Sets the number of marker readouts to display per trace. Display up to 20 marker readouts per window.

See other SCPI [Marker](#) commands. Learn more about [Marker readout](#).

Parameters

- <wnum> Any existing window number. If unspecified, value is set to 1.
- <num> Number of marker readouts to display. Choose a value between 1 and 10.

Examples

```
DISP:WIND:ANN:MARK:NUMB 7
display>window:annotation:marker:number 2
```

Query Syntax DISPlay:WINDow:ANNotation:MARKer:NUMBer?

Return Type Numeric

Default 5

[DISPlay:WINDow<wnum>:ANNotation:MARKer:RESolution:RESPonse <num>](#)

Applicable Models: E5080A, M9485A

(Read-Write) For the Y-axis (response), sets the number digits to display after the decimal point in marker readouts.

See other SCPI [Marker](#) commands. Learn more about [Marker readout](#).

Parameters

- <wnum> Any existing window number. If unspecified, value is set to 1.

<num> Number of digits to display. Choose a value between 1 and 4.

Examples `DISP:WIND:ANN:MARK:RES:RESP 1`
`display:window:annotation:marker:resolution:stimulus 2`

Query Syntax `DISPlay:WINDow:ANNotation:MARKer:RESolution:RESPonse?`

Return Type Numeric

Default 2

[DISPlay:WINDow<wnum>:ANNotation:MARKer:RESolution:STIMulus <num>](#)

Applicable Models: E5080A, M9485A

(Read-Write) For the X-axis (stimulus), sets the number digits to display after the decimal point in marker readouts.

See other SCPI [Marker](#) commands. Learn more about [Marker readout](#).

Parameters

<wnum> Any existing window number. If unspecified, value is set to 1.

<num> Number of digits to display. Choose a value between 2 and 6.

Examples `DISP:WIND:ANN:MARK:RES:STIM 2`
`display:window:annotation:marker:resolution:stimulus 4`

Query Syntax `DISPlay:WINDow:ANNotation:MARKer:RESolution:STIMulus?`

Return Type Numeric

Default 3

[DISPlay:WINDow<wnum>:ANNotation:MARKer:SIZE | SIZE <char>](#)

Applicable Models: E5080A, M9485A

(Read-Write) Specifies the size of the marker readout text. See other SCPI [Marker](#) commands. Learn more about [Marker readout](#).

Parameters

<wnum> Any existing window number. If unspecified, value is set to 1.

<char> Readout text size. Choose from:**NORMAL** | **LARGE**

Examples `DISP:WIND:ANN:MARK:SIZ LARG`
`display:window:annotation:marker:size normal`

Query Syntax `DISPlay:WINDow<wnum>:ANNotation:MARKer:SIZE | SIZE?`

Return Type Character

Default NORMAl

DISPlay:WINDow<wnum>:ANNOtation:MARKer[:STATe] <bool>

Applicable Models: E5080A, M9485A

(**Read-Write**) Specifies whether to show or hide the Marker readout (when markers are ON) on the selected window. See other SCPI [Marker](#) commands. Learn more about [Marker readout](#).

Parameters

<wnum> Any existing window number. If unspecified, value is set to 1.

<bool> **ON or 1** - Turns marker readout ON.
OFF or 0 - Turns marker readout OFF.

Examples `DISP:WIND:ANN:MARK ON`
`display>window:annotation:marker:state off`

Query Syntax DISPlay:WINDow:ANNOtation:MARKer[:STATe]?

Return Type Boolean

Default ON

DISPlay:WINDow<wnum>:ANNOtation:MARKer:SYMBol <char>

Applicable Models: E5080A, M9485A

(**Read-Write**) Sets the symbol to display for marker position. See other SCPI [Marker](#) commands.

Parameters

<wnum> Any existing window number. If unspecified, value is set to 1.

<char> Marker symbol. Choose from:

- TRlangle
- FLAG
- LINE

[See pictures of each](#)

Examples `DISP:WIND:ANN:MARK:SYMB TRI`
`display>window:annotation:marker:symbol line`

Query Syntax DISPlay:WINDow:ANNOtation:MARKer:SYMBol?

Return Type Character

Default TRlangle

DISPlay:WINDow<wnum>:ANNotation:MARKer:XPOSition <num>

Applicable Models: E5080A, M9485A

(Read-Write) Sets the X-axis position of marker readouts. Readouts are right-justified at the specified position.

See other SCPI [Marker](#) commands. Learn more about [Marker readout](#).

Parameters

<wnum> Any existing window number. If unspecified, value is set to 1.

<num> X-axis position. Choose a value between 1 (far left) and 10 (far right).

Examples

```
DISP:WIND:ANN:MARK:XPOS 1.5
display>window:annotation:marker:xposition 5
```

Query Syntax DISPlay:WINDow:ANNotation:MARKer:XPOSition?

Return Type Numeric

Default 10

DISPlay:WINDow<wnum>:ANNotation:MARKer:YPOSition <num>

Applicable Models: E5080A, M9485A

(Read-Write) Sets the Y-axis position of marker readouts. Readouts are top-justified at the specified position.

See other SCPI [Marker](#) commands. Learn more about [Marker readout](#).

Parameters

<wnum> Any existing window number. If unspecified, value is set to 1.

<num> Y-axis position. Choose a value between 1 (bottom) and 10 (top).

Examples

```
DISP:WIND:ANN:MARK:YPOS 1.5
display>window:annotation:marker:yposition 5
```

Query Syntax DISPlay:WINDow:ANNotation:MARKer:YPOSition?

Return Type Numeric

Default 10

DISPlay:WINDow<wnum>:ANNotation[:TRACe][:STATE] <bool>

Applicable Models: E5080A, M9485A

(Read-Write) Specifies whether to show or hide the Trace Status buttons on the top of the display.

Parameters

<wnum> Any existing window number. If unspecified, value is set to 1.

<bool> **ON or 1** - Turns the buttons ON.
OFF or 0 - Turns the buttons OFF.

Examples

```
DISP:WIND:ANN ON
display>window:annotation:trace:state off
```

Query Syntax DISPlay:WINDow:ANNotation[:TRACe][:STATe]?

Return Type Boolean

Default ON or 1

[DISPlay:WINDow<wnum>:ANNotation: Y\[:STATe\] <bool>](#)

Applicable Models: E5080A, M9485A

(Read-Write) Turns ON or OFF the Y-axis scale label in display window.

Parameters

<wnum> Any existing window number. If unspecified, value is set to 1.

<bool> **ON or 1** - Turns ON the Y-axis scale.
OFF or 0 - Turns OFF the Y-axis scale.

Examples

```
DISP:WIND:ANN:Y ON
display>window:annotation:y off
```

Query Syntax DISPlay:WINDow:ANNotation:Y?

Return Type Boolean

Default ON or 1

[DISPlay:WINDow<wnum>:CATalog?](#)

Applicable Models: E5080A, M9485A

(Read-only) Returns the trace numbers for the specified window.

Parameters

<wnum> Any existing window number. If unspecified, value is set to 1.

Example

```
Window 1 with four traces:
DISPlay:WINDow1:CATalog?
Returns:
"1,2,3,4"
```

Return Type String of Character values separated by commas

Default Not Applicable

[DISPlay:WINDow<wnum>:ENABle <bool>](#)

Applicable Models: E5080A, M9485A

(Read-Write) Specifies whether to disable or enable all analyzer display information in the specified window. Marker data is not updated. More CPU time is spent making measurements instead of updating the display.

Parameters

<wnum> Any existing window number. If unspecified, value is set to 1.

<bool> **ON** (or 1) - turns the display ON.
OFF (or 0) - turns the display OFF.

Examples `DISP:WIND:ENABle ON`
`display:window1:enable off`

Query Syntax DISPlay:WINDow<wnum>:ENABle?

Return Type Boolean

Default ON

[DISPlay:WINDow<wnum>:NEXT\[:NUMBer\]?](#)

Applicable Models: E5080A, M9485A

(Read-only) Returns the lowest window number which has less than the maximum number of traces. Basically, returns the first window which has room for another trace. Note that the window may need to be turned on first (i.e. disp:wind:stat ON may be needed).

Parameters

<wnum> Any existing window number. If unspecified, value is set to 1.

Examples `DISP:WIND:NEXT`
`display:window1:NEXT`

Query Syntax DISPlay:WINDow<wnum>:NEXT?

Return Type

Default

[DISPlay:WINDow<wnum>:SIZe<char>](#)

Applicable Models: E5080A, M9485A

(Read-Write) Sets or returns the window setting of Maximized, Minimized or Normal. To arrange all of the windows, use [DISP:ARR.](#)

Parameters

<wnum> Any existing window number. If unspecified, value is set to 1

<char> Window size. Choose from:

MAX | NORM

Examples

```
DISP:WIND:SIZ MAX
display:window:size norm
```

Query Syntax DISPlay:WINDow:SIZE?

Default Not Applicable

DISPlay:WINDow<wnum>[:STATe] <bool>

Applicable Models: E5080A, M9485A

(**Read-Write**) To create or delete a window on the screen or **Read** whether a window is present.

Parameters

<wnum> Window number to create; choose any integer between 1 and the [maximum number of windows allowed in the VNA](#).

<bool> **ON or 1** - The window <wnum> is created.
OFF or 0 - The window <wnum> is deleted.

Examples

```
DISP:WIND ON
display:window2:state off
```

Query Syntax DISPlay:WINDow<wnum>[:STATe]?

Return Type Boolean

Default Window number "1" **ON**

DISPlay:WINDow<wnum>:TABLe <char>

Applicable Models: E5080A, M9485A

(**Read-Write**) **Write** to show the specified table at the bottom of the analyzer screen or **Read** to determine what table is visible.

Parameters

<wnum> Any existing window number. If unspecified, value is set to 1

<char> Table to show. Choose from:
OFF | MARKer | LIMit | SEGMENT

Examples

```
DISP:WIND:TABLE SEGM
display:window:table off
```

Query Syntax DISPlay:WINDow:TABLE?

Default OFF

[DISPlay:WINDow<wnum>:TITLe:DATA <string>](#)

Applicable Models: E5080A, M9485A

(Read-Write) Sets data in the window title area. The title is turned ON and OFF with [DISP:WIND:TITL:STAT OFF](#).

Parameters

- <wnum> Any existing window number. If unspecified, value is set to 1.
- <string> Title to be displayed. Any characters, enclosed with quotes. If the title string exceeds 50 characters, an error will be generated and the title not accepted. Newer entries replace (not append) older entries.

Examples `DISP:WIND:TITL:DATA 'hello'`
`display:window2:title:data 'hello'`

Query Syntax DISPlay:WINDow<wnum>:TITLe:DATA?

Return Type String

Default Not Applicable

[DISPlay:WINDow<wnum>:TITLe\[:STATe\] <bool>](#)

Applicable Models: E5080A, M9485A

(Read-Write) Turns display of the title string ON or OFF. When OFF, the string remains, ready to be re-displayed when turned back ON.

Parameters

- <wnum> Any existing window number. If unspecified, value is set to 1
- <bool> **ON or 1** - Turns the title string ON.
OFF or 0 - Turns the title string OFF.

Examples `DISP:WIND:TITL ON`
`Display:window1:title:state off`

Query Syntax DISPlay:WINDow<wnum>:TITLe[:STATe]?

Return Type Boolean

Default ON

[DISPlay:WINDow<wnum>:TRACe<tnum>:DELeTe](#)

Applicable Models: E5080A, M9485A

(Write-only) Deletes the specified trace from the specified window. The measurement parameter associated with the trace is not deleted.

Parameters

- <wnum> Any existing window number. If unspecified, value is set to 1.
- <tnum> The number of the trace to be deleted; if unspecified, value is set to 1.

Note: This is **NOT** the trace number of the channel which appears as the [Tr annotation](#) on the Trace Status display. This <tnum> is the trace number within the specified window, and is used **ONLY** for remote programs.

Examples `DISP:WIND:TRAC:DEL`
`display>window2:trace2:delete`

Query Syntax Not Applicable

Default Not Applicable

`DISPlay:WINDow:TRACe:GRATicule:GRID:LTYPE <value>`

Applicable Models: E5080A, M9485A

(Read-Write) Sets and returns the grid line type (solid | dotted) for all open windows. Grid is returned to solid when the VNA is Preset. [Learn more.](#)

Parameters

- <value> Line type. Choose from:
SOLid - Solid lines
DOTTed - Dotted lines

Examples `DISP:WIND:TRAC:GREAT:GRID:LTYPE SOL`
`display>window:trace:graticule:grid:ltype dotted`

Query Syntax `DISPlay:WINDow:TRACe:GRATicule:GRID:LTYPE?`

Return Type Character

Default SOLID

[DISPlay:WINDow:TRACe:Y\[:SCALe\]:COUPlE:METhod <char>](#)

Applicable Models: E5080A, M9485A

(Read-Write) Sets and returns the method of scale coupling. [Learn more](#) about Scale coupling.

Parameters

<char> **OFF** - NO scale coupling for any windows.
WINDow - Scale settings are coupled for traces in each window.
ALL - Scale settings are coupled for traces in ALL selected windows.
 Enable the selected windows using [DISP:WIND:TRAC:Y:COUP ON](#)

Examples `DISP:WIND:TRAC:Y:COUP:METHOD ALL`
`Display>window2:trace:y:scale:method window`

Query Syntax `DISPlay:WINDow:TRACe:Y[:SCALe]:COUPlE:METhod?`

Return Type Character

Default OFF

[DISPlay:WINDow<wnum>:TRACe:Y\[:SCALe\]:COUPlE\[:STATe\] <bool>](#)

Applicable Models: E5080A, M9485A

(Read-Write) Enables and disables scale coupling for the specified window. [Learn more](#) about Scale coupling.

Parameters

<wnum> Any existing window number. If unspecified, value is set to 1
 Use [Disp:Cat?](#) to read the existing window numbers.

<bool> **ON or 1** - Scale coupling enabled for specified window.
OFF or 0 - Scale coupling disabled for specified window.

Examples `DISP:WIND:TRAC:Y:COUP ON`
`Display>window2:trace:y:scale:couple:state off`

Query Syntax `DISPlay:WINDow<wnum>:TRACe:Y[:SCALe]:COUPlE[:STATe]?`

Return Type Boolean

Default ON or 1

[DISPlay:WINDow<wnum>:Y\[:SCALe\]:DIVisions <num>](#)

Applicable Models: E5080A, M9485A

(Read-Write) Sets or returns the number of divisions in all the graphs, for the selected channel

Parameters

- <wnum> Any existing window number. If unspecified, value is set to 1
Use [Disp:Cat?](#) to read the existing window numbers.
- <bool> **ON or 1** - Scale coupling enabled for specified window.
OFF or 0 - Scale coupling disabled for specified window.
- <num> Number of divisions is between 4 to 30.
Units / division value. The range of acceptable values is dependent on format and domain.

Note: This command will accept **MIN** or **MAX** instead of a numeric parameter. See [SCPI Syntax](#) for more information.

Examples

```
DISP:WIND:Y:DIV 12
Display>window2:y:scale:divisions 12
```

Query Syntax DISPlay:WINDow<wnum>:Y[:SCALE]:DIVisions?

Return Type Boolean

Default 10

[DISPlay:WINDow<wnum>:Y:AUTO](#)

Applicable Models: E5080A, M9485A

(Write-only) Scales **ALL** of the traces to fit in the same window. This is equivalent to "Autoscale All" from the front panel.

Autoscale behaves differently when [scale coupling](#) is enabled. How it behaves depends on the scale coupling method. [Learn more.](#)

Autoscale is performed only when the command is sent; it does NOT keep the trace autoscaled indefinitely.

See Also, [DISPlay:WINDow:TRACe:Y:AUTO](#) which Autoscales only the specified trace.

Parameters

- <wnum> Any existing window number. If unspecified, value is set to 1.
Use [Disp:Cat?](#) to read the existing window numbers.

Examples

```
DISP:WIND:Y:AUTO
display>window2:y:auto
```

Query Syntax Not Applicable

Default Not Applicable

Last modified:

E5080A

29-Sep-2015 First Release



Format Commands

Specifies the way that data will be transferred when moving large amounts of data.

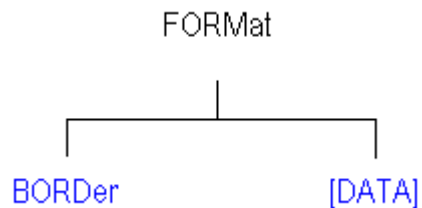

FORMat:

[BORDer](#)

[\[DATA\]](#)

Click on a [Red](#) keyword to view the command details.

See Also

- Example Programs
- [Synchronizing the VNA and Controller](#)
- [SCPI Command Tree](#)

FORMat:BORDer <char>

Applicable Models: E5080A, M9485A

(Read-Write) Set the byte order used for GPIB data transfer. Some computers read data from the analyzer in the reverse order. This command is only implemented if FORMAT:DATA is set to :REAL.

If FORMAT:DATA is set to :ASCII, the swapped command is ignored.

Parameters

<char> Choose from:
NORMal - Use when your controller is anything other than an IBM compatible computers.

SWAPped - for IBM compatible computers.

Note: Use **NORMal** if you are using VEE, LabView or T&M Tool kit.

Examples

```

FORM:BORD SWAP
format:border normal
  
```

Query Syntax FORMat:BORDer?

Return Type Character

Default Normal

FORMat[:DATA] <char>

Applicable Models: E5080A, M9485A

(Read-Write) Sets the data format for transferring measurement data and frequency data.

- To transfer measurement data, use [CALC:DATA](#).
- To transfer Cal Set data, use [SENS:CORR:CSET:DATA](#)
- To transfer Source Power correction data, use:
 - [SOURce:POWer:CORRection:COLLect:TABLE:DATA](#)
 - [SOURce:POWer:CORRection:COLLect:TABLE:FREQuency](#)
 - [SOURce:POWer:CORRection:DATA](#)
- To transfer FIFO buffer data, use SYST:FIFO:DATA?

The following commands transfer frequency data. Use **<REAL, 64>**

- [CALC:DATA:SNP?](#)
- [CALC:DATA:SNP:PORTS?](#)
- CALC:X?
- SENS:X?

Use [FORMat:BORDER](#) to change the byte order. Use "NORMal" when transferring a binary block from LabView or VEE. For other programming languages, you may need to SWAP the byte order.

Parameters

<char> In the VNA, measurement data is stored as 32 bit and frequencies stored as 64 bit. Therefore, use REAL,32 when getting data and REAL,64 when getting frequencies. That way you are guaranteed to avoid losing any precision as well as getting the maximum speed on the data transfer.

Choose from:

- **REAL,32** - (default value for REAL) Best for transferring large amounts of measurement data. Can cause rounding errors in frequency data.
- **REAL,64** - Slower but has more significant digits than REAL,32. REQUIRED to accurately represent frequency data. See above list for commands which transfer frequency information.
- **ASCii,0** - The easiest to implement, but very slow. Use when you have small amounts of data to transfer.

Note: The REAL,32 and REAL,64 arguments transfer data in block format as explained in [Transferring Measurement Data](#).

Note: The default value for REAL of the E507x, E506x is REAL, 64.

Examples

```
FORM REAL,64
iformat:data ascii
```

Query Syntax FORMat:DATA?

Return Type Character,Character

Default **ASCIi,0**

Syst:Preset does NOT reset this command.

However, *RST does reset this command to ASCIi,0

Last Modified:

29-Sep-2015 First Release



Hardcopy Command

Controls printing of the VNA screen and optional data to a printer or a file.

```
HCOPY:
  [IMMediate]
  FILE
  SDUMP
    | DATA?
    | FORMat
```

Click on a **Red** keyword to view the command details.

See Also

- [Learn more about VNA Printing](#)
- Example Programs
- [Synchronizing the VNA and Controller](#)

HCOPY:[IMMediate]

Applicable Models: E5080A, M9485A

(Write-only) Prints the screen to the default printer.

Examples `HCOPY`
`hcopy:immediate`

Query Syntax Not applicable

Default Not Applicable

HCOPY:FILE <filename>

Applicable Models: E5080A, M9485A

(Write-only) Saves the screen image to a file. The image does NOT include the optional print data invoked by many HCOpy commands.

Parameters

<filename> Name of the file to save the screen to. The file is saved to the current working directory unless a valid full path name is specified.

Use one of the following suffixes:

.bmp - not recommended due to large file size

.jpg - not recommended due to poor quality

.png - recommended

Examples `HCOPY:FILE "myFile.png"`
`hcopy:file "D:\myfile.png"`

Query Syntax Not Applicable

Default Not Applicable

[HCOPY:SDUMp:DATA?](#)

Applicable Models: E5080A, M9485A

(Read-only) Returns the display image in a definite-length arbitrary binary block. The format of the data is PNG by default. Use [HCOPY:SDUM:DATA:FORM](#) to change the format.

This command is equivalent to saving an image to the VNA ([HCOPY:FILE](#)) and then using [MMEM:TRAN](#) to transfer the file to the computer.

Examples

```
HCOPY:SDUM?
hcopy:sdump?
```

Return Type A definite-length arbitrary binary block

Default Not Applicable

[HCOPY:SDUMp:DATA:FORMat <char>](#)

Applicable Models: E5080A, M9485A

(Read-Write) Sets the graphic format for [HCOPY:SDUMp:DATA?](#)

Parameters

<char> Choose from: **JPG** | **BMP** | **PNG**

Examples

```
HCOPY:SDUMp:DATA:FORMat BMP
```

Query Syntax HCOPY:SDUMp:DATA:FORMat?

Return Type Character

Default PNG

Last modified:

29-Sep-2015 First Release



Initiate Commands

Controls triggering signals

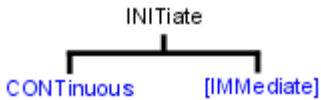

INITiate:

[CONTInuous](#)

[IMMediate](#)

Click on a **Red** keyword to view the command details.

See Also

- **Example** [Triggering the VNA](#)
- [Learn about Triggering](#)
- [Synchronizing the VNA and Controller](#)
- [SCPI Command Tree](#)

INITiate:CONTInuous <bool>

Applicable Models: E5080A, M9485A

(Read-Write) Specifies whether the VNA trigger source is set to Internal (continuous) or Manual.

- For SIMPLE, single-triggering of a single channel, use [SENS:SWE:MODE SING](#) which sets the number of trigger signals each channel will ACCEPT (Continuous, Groups, **Single**, or HOLD - none.)
- This command is a subset of [TRIG:SEQ:SOURce](#), which can also set the trigger source to External.
- See a map of user interface to SCPI triggering commands.
- For more information on triggering, see the [VNA Trigger Model](#).
- **See the Example program:** [Triggering the VNA using SCPI](#).

Parameters

<bool> **ON** (or 1) - Internal (continuous) trigger.
OFF (or 0) - Manual sweep. Use [INIT:IMMediate](#) to send a trigger signal

Examples

```
INIT:CONT ON
initiate:continuous off
```

Query Syntax INITiate:CONTInuous?

Return Type Boolean (1 = ON, 0 = OFF)

Default ON

INITiate<cnum>[:IMMediate]**Applicable Models:** E5080A, M9485A

(Write-only) Stops the current sweeps and immediately sends a trigger. (Same as [Manual Trigger!](#) in the Trigger dialog box.)

- This command requires [Trigger:Source](#) to be set to Manual. This causes ONE trigger signal to be SENT each time INIT:IMM is issued.
- For SIMPLE, single-triggering of a single channel, use [SENS:SWE:MODE SING](#) which sets the number of trigger signals each channel will ACCEPT (Continuous, Groups, **Single**, or HOLD - none.)

See the Example program: [Triggering the VNA using SCPI](#)

Note: An **SMC Fixed Output** measurement cannot be triggered using this command. For more information, see the example program.

To trigger ALL channels in turn:

Set ALL channels to Sens<ch>:Sweep:Mode Continuous. The <ch> argument in INIT<ch>:IMM is ignored.

Then...

- TRIG:SCOP ALL triggers ALL channels (in sequence) each time Init:Imm is sent.
- TRIG:SCOP CURRent triggers ONLY the NEXT channel each time Init:Imm is sent.

To trigger ONLY a specified channel:

1. Set ALL channels to Sens<ch>:Sweep:Mode HOLD
2. Send TRIG:SCOP CURRent
3. Send Init<ch>:Imm where <ch> is the channel to be triggered.

Advanced Situations that require some channels to be in CONT and others in HOLD are rare. The following describes the behavior of the Init:Imm command in these situations:

When [Trigger:Scope](#) = Global:

- If the SPECIFIED <cnum> channel is in hold mode, it is put in single trigger (accepts 1 trigger signal) and goes to the end of the queue of channels to be triggered. The other 'non-hold' channels are triggered. The next Init:Imm triggers the specified channel first.

For example: ch1 is in Hold, ch2 and ch3 are in CONT and we send INIT1:IMM

- On the first INIT:IMM, ch2 and ch3 is triggered.
- next INIT:IMM, ch1, ch2, ch3 is triggered.
- next INIT:IMM, ch2 and ch3 is triggered.
- next INIT:IMM, ch1, ch2, ch3 is triggered, and so forth.

When [Trigger:Scope](#) = Channel

- Only ONE channel is triggered for each issued INIT<ch>:IMM command.
- If the specified channel is in hold, it is put in single trigger (accepts 1 trigger signal) and goes the end of the queue of channels to be triggered as in the 'Global' example.

This is one of the VNA overlapped commands. [Learn more.](#)

Parameters

<cnum> Any existing channel number. If unspecified, value is set to 1

Examples

```
INIT  
initiate2:immediate
```

Query Syntax Not Applicable

Default Not Applicable

Last modified:

29-Sep-2015 First Release

Memory Commands

The memory commands control saving and loading instrument states and measurement trace data to the hard drive. To read and write trace data in GPIB format, see [CALC:DATA](#).

MMEMory:

CATalog?

- | CORRection?
- | CSARchive?
- | CSTate?
- | [:FILE]?
- | STATe?

CDIRectory

COPY

DATE?

DELeTe

LOAD

- | ASCFactor
- | BSCFactor
- | CORRection
- | CSARchive
- | ENR
- | [:FILE]
- | [LIMit](#)
- | [RLIMit](#)
- | SEGMeNt
- | STATe

MDIRectory

MOVE

RDIRectory

STORe

- | ASCFactor
- | BSCFactor
- | CORRection
- | CSARchive
- | CSTate
- | CSV:FORMat
- | [DATA](#)
- | ENR
- | [FILE]
- | [LIMit](#)

PLOs
RLIMit
SEGMENT
SSCreen
STATE
TRACe
TRACe
FORMat
SNP
TRANsfer

Click on a **Red** keyword to view the command details.

See Also

- Example Programs
- [Learn about Save/Recall and File Types](#)
- [Synchronizing the VNA and Controller](#)
- [SCPI Command Tree](#)

Specifying Path Names

The MMEM commands use the following rules to specify path names:

- The default folder is "D:\\" [Learn more.](#)

- You can change the active directory using [MMEMory:CDIRectory](#).
- Specify only the file name if using the active directory.
- You can also use an absolute path name to specify the folder and file.

MMEMory:CATalog[:<char>]? [<folder>]

Applicable Models: E5080A, M9485A

(Read-only) Returns a comma-separated string of file names that are in the specified folder. If there are no files of the specified type, "NO CATALOG" is returned. [Learn about File Types](#)

Parameters

<char> The type of files to list. Choose from:

- **CORRection** - Calibration Data (.cal)
- **CSARchive** - Instrument state and calibration data (.csa)
- **CSTate** - Instrument state and link to Calibration data (.cst)
- **[:File]**
- **STATe** - Instrument states (.sta)

If unspecified then ALL file types (even unknown types) are listed.

<folder> String - Any existing folder name. See [Specifying Path Names](#)

Examples

```
MMEM:CAT? 'lists all files from the current folder
mmemory:catalog:correction? c:\users\public\documents\Network
analyzer\Documents' 'lists .cal files from the specified
folder'
```

Default Not Applicable

MMEMory:CDIRectory <folder>

Applicable Models: E5080A, M9485A

(Read-Write) Changes the folder name.

Parameters

<folder> Any drive and folder name that already exists.

If the same level as the default path, then no punctuation is required.

```
MMEM:CDIR Service
```

If the new folder is at a different level than the default, use a slash (/) before the folder name and enclose in quotes.

```
mmemory:cdirectory '/automation' 'changes default directory up
one level.'
```

You can use an absolute path to specify the new folder.

```
mmemory:cdirectory 'c:/automation/service'
```

Query Syntax MMEMory:CDIRectory? 'Returns the current folder name

Return Type String

Default See [Specifying Path Names](#)

MMEMory:COPY <file1>,<file2>

Applicable Models: E5080A, M9485A

(Write-only) Copies file1 to file2. Extensions must be specified.

Parameters

<file1> String - Name of the file to be copied. See [Specifying Path Names](#)

<file2> String - Name of the file to be created from file1.

Examples `MMEM:COPY 'MyFile.cst','YourFile.cst'`

Query Syntax Not Applicable

Default Not Applicable

MMEMory:DATE? <fileName>

Applicable Models: E5080A, M9485A

(Read-only) Returns the (year, month, day) that the specified file was last saved.

To query the last date and time a cal set was modified, use [CSET DATE?](#) and [CSET:TIME?](#)

See Also

[MMEM:TIME?](#)

Parameters

<fileName> String - File name. See [Specifying Path Names](#)

Example `MMEM:DATE? "myFile.txt"`

'Returns

`+2013,+4,+12`

`mmemory:date? "c:\users\public\documents\Network analyzer\UserCalSets\Calset_18.pcs"`

'Returns

`+2013,+4,+12`

Return Type Comma-separated integers

Default Not applicable

MMEMory:DELeTe <file>

Applicable Models: E5080A, M9485A

(Write-only) Deletes file. Extensions must be specified.

Parameters

<file> String - Name of the file to be deleted. See [Specifying Path Names](#)

Examples `MMEM:DEL 'MyFile.cst'`

Query Syntax Not Applicable

Default Not Applicable

MMEemory:LOAD[:<char>] <file>

Applicable Models: E5080A, M9485A

(Write-only) Loads the specified file. [Learn about File Types](#)

Parameters

<char> The type of file to load. Choose from:

- **ASCFactor**
- **BSCFactor**
- **CORRection** - Calibration Data (.cal)
- **CSARchive** - Instrument state and calibration data (.csa)
- **ENR** - Excess Noise Source data (Noise Figure App only)
- **[:File]**
- **SEGMENT**
- **STATe** - Instrument states (.sta)
- When <char> is **ENR**, then include **CAL**, - See example below.
- *.sNp files CAN be recalled to the VNA although no <char> is used. See example below.

If <char> is unspecified, the extension must be included in the filename.

If an extension is specified in <file> that does not agree with <char> then no action is taken.

<file> String - Name of the file to be loaded. See [Specifying Path Names](#)

Examples `MMEM:LOAD 'MyFile.cst'`
`mmemory:load:state 'MyInstState'`
`MMEM:LOAD:ENR CAL, C:/data/calset/346C_16500.enr"`
`MMEM:LOAD "MyFile.s2p"`

Query Syntax Not Applicable

Default Not Applicable

MMEemory:LOAD:LIMit <file>

E5080A

Applicable Models: E5080A, M9485A

(Write-only) Load limit test data from a CSV file.

Parameters

<file> A file path by string format.
The CSV file shall have header lines and a title row as follows.
"# E5080 Limit Test"
"# Revision: 1.00"
TYPE,BEGIN STIMULUS,END STIMULUS,BEGIN RESPONSE,END RESPONSE

Examples `MMEM:LOAD:LIM 'MyFile.csv'`

Query Syntax Not Applicable

Default Not Applicable

MMEemory:LOAD:RLIMit <file>

Applicable Models: E5080A, M9485A

(Write-only) Load ripple limit test data from a CSV file.

Parameters

<file> A file path by string format.
The CSV file shall have header lines and a title row as follows.
"# E5080 Ripple Limit Test"
"# Revision: 1.00"
TYPE,BEGIN STIMULUS,END STIMULUS,MAX RIPPLE

Examples `MMEM:LOAD:RLIM 'MyFile.csv'`

Query Syntax Not Applicable

Default Not Applicable

MMEemory:MDIRectory <folder>

Applicable Models: E5080A, M9485A

(Write-only) Makes a folder.

Parameters

<folder> String - Name of the folder to make. See [Specifying Path Names](#)

Examples `MMEM:MDIR 'MyFolder'`
`mmemory:mdirectory 'c:/NewFolder'`

Query Syntax Not Applicable

Default Not Applicable

MMEMory:MOVE <file1>,<file2>

Applicable Models: E5080A, M9485A

(Write-only) Renames <file1> to <file2>. File extensions must be specified.

Parameters

<file1> String - Name of the file to be renamed. See [Specifying Path Names](#)

<file2> String - Name of the new file.

Examples `MMEM:MOVE 'MyFile.cst','YourFile.cst'`

Query Syntax Not Applicable

Default Not Applicable

MMEMory:RDIRECTory <folder>

Applicable Models: E5080A, M9485A

(Write-only) Removes the specified folder.

Parameters

<folder> String - Name of the folder to remove. See [Specifying Path Names](#).

Examples `MMEM:RDIR 'MyFolder'`

Query Syntax Not Applicable

Default Not Applicable

MMEMory:STORE[:<char>] <file>

Applicable Models: E5080A, M9485A

(Write-only) Stores the specified file (.sta, .cal, .cst, .csa, .snp, s2px).

Learn about [saving SNP files on the VNA](#).

Learn about [saving S2Px files on the VNA](#).

To save other data files, use [MMEM:STOR:DATA](#).

To save ENR files, use [MMEMory:STORE:ENR](#)

Parameters

<char> Optional argument. The type of file to store. Choose from:

- **ASCFactor**
- **BSCFactor**
- **CORRection** - Calibration Data (.cal)
- **CSARchive** - Instrument state and calibration data (.csa)
- **CStAte** - Instrument state and link to Calibration data (.cst)
- **CSV:FORMAt**
- **ENR**
- **[:File]**
- **PLOsS**
- **SEGMeNt**
- **SSCReen**
- **STATe** - Instrument states (.sta)
- **STATe:TRACe**
- **TRACe**

No <char> is specified for s1p, s2p, s2px and so forth.

Include either <char> or the file extension. If both <char> and the extension are specified, they must agree or an error is returned and no action is taken. See examples below.

[Learn about File Types](#)

<file> String - Name of any valid file that does not already exist. See [Specifying Path Names](#)

Examples

```
MMEM:STOR:STAT 'myState'
mmemory:store 'c:/bin/myState.sta'
MMEM:STOR 'MyData.S2P'
```

Query Syntax Not Applicable

Default Not Applicable

MMEMory:STORe:DATA <filename>,<type>,<scope>,<format>,<selector>

Applicable Models: E5080A, M9485A

(Write-only) Stores trace data to the following file types: *.prn, *.cti, *.csv, *.mdf

To save snp files, use [Calc:Data:SNP:PORTs:SAVE](#)

To save state and calibration files, use [MMEM:STORe](#)

This command replaces the following:

- [MMEMory:STORe:CITifile:DATA](#)
- [MMEMory:STORe:CITifile:FORMAt](#)
- [MMEMory:STORe:TRACe:CONTent:CITifile](#)

- [MMEMory:STORE:TRACe:FORMat:CITifile](#)

NOTE: Not all choices are valid with other arguments. See [Valid parameter combinations](#) below.

Parameters

<filename> (String) Name and extension of the file to which data will be saved. If the extension does not agree with the file type, an error is NOT returned but the data may NOT be what you expect.

[See rules for specifying a filename.](#)

<type> (String) File type to save. Choose from:

"PRN Trace Data" - *.prn data. [Learn more.](#)

"Citifile Data Data" - unformatted *.cti data. [Learn more.](#)

"Citifile Formatted Data" - formatted *.cti data.

"CSV Formatted Data" - formatted *.csv data. [Learn more.](#)

"MDIF Data" - *.mdf data. [Learn more.](#)

"GCA Sweep Data" - Gain compression data. [Learn more.](#) (Excepts E5080A, M9485A)

"IMD Sweep Data" - Swept IMD data. [Learn more.](#) (Excepts E5080A, M9485A)

<scope> (String) How much data to save. Choose from:

"Trace" - only the specified measurement number is saved.

"Displayed" - all displayed measurements are saved.

"Channel" - all measurements that are in the channel in which the selected measurement reside are saved.

"Auto"

For all Standard Meas Class (S-parameter) channels:

- When correction is OFF, the specified trace is saved.
- When correction is ON, all corrected parameters associated with the calibrated ports in the Cal Set are saved.

For all other channels:

- When correction is OFF or ON, the specified trace is saved.

<format> The format in which data is saved. Choose from:

"Displayed" - the format is the same as that in which it is displayed on the VNA screen.

"RI" - Real / Imaginary

"MA" - Magnitude / Angle

"DB" - LogMag / Degrees

<selector> (Integer) Choose from:

-1 Use when <scope> = "Displayed" (does NOT require a selected trace).

<measurement number> Use for all other <scope> selections. Use

[Calc:Par:MNUM?](#) to read the measurement number of the selected trace.

The following are **valid parameter combinations** for ALL measurement classes:

Parameters			
<type> (String)	<scope> (String)	<format> (String)	<selector> (Numeric)
"PRN Trace Data"	"Trace"	"Displayed"	Measurement number
Example: MMEMemory:STORe:DATA "myData.prn","PRN Trace Data","Trace","Displayed",2			
"Citifile Data Data"	"Trace" or "Auto" or "Channel"	"RI"	Measurement number
	"Displayed"	"RI"	-1
Example: MMEMemory:STORe:DATA "myData.cti","Citifile Data Data","AUTO","RI",3			
"Citifile Formatted Data"	"Trace" or "Auto"	"RI" or "MA" or "DB"	Measurement number
	"Channel"	"RI" or "MA" or "DB" or "Displayed"	Measurement number
	"Displayed"	"RI" or "MA" or "DB" or "Displayed"	-1
Example: MMEMemory:STORe:DATA "myData.cti","Citifile Formatted Data","AUTO","MA",3			
"CSV Formatted Data"	"Trace" or "Auto" or "Channel"	"RI" or "MA" or "DB" or "Displayed"	Measurement number
	"Displayed"	"RI" or "MA" or "DB"	-1
Example: MMEMemory:STORe:DATA "myData.csv","CSV Formatted Data","displayed","RI",-1			
"MDIF Data"	"Trace" or "Auto"	"RI" or "Displayed" or "Channel"	Measurement number
	"Displayed"	"RI" or "Displayed"	-1
Example: MMEMemory:STORe:DATA "myData.mdf","MDIF Data","displayed","displayed",-1			

The following parameter combinations save *.csv files in specific formats for GCA and Swept IMD classes: (Excepts E5080A, M9485A)

Parameters			
<type> (String)	<scope> (String)	<format> (String)	<selector> (Numeric)
"GCA Sweep Data"	"Auto"	"DB"	GCA channel number
Example: <code>MMEemory:STORe:DATA "myData","gca sweep data","displayed","displayed",-1</code>			
"IMD Sweep Data"	"Auto"	"DB"	Swept IMD channel number
Example: <code>MMEemory:STORe:DATA "myData.mdf","MDIF Data","displayed","displayed",-1</code>			

Query Syntax Not Applicable

Default Not Applicable

[MMEemory:STORe:ENR <file>](#)

Applicable Models: E5080A, M9485A

(Write-only) Stores an **ENR** (Excess Noise Source) data. (Noise Figure App only)

To set and read ENR data, use [SENS:CORR:ENR:CAL:TABLE:DATA](#).

Parameters

<file> String - Name of any valid file that is not already in existence. See [Specifying Path Names](#)

Examples `MMEemory:STORe:ENR "C:/data/calset/346C_16500.enr"`

Query Syntax Not Applicable

Default Not Applicable

[MMEemory:STORe:LIMit <file>](#)

Applicable Models: E5080A, M9485A

(Write-only) Saves limit test data into a CSV file.

Parameters

<file> A file path by string format.
The CSV file shall have header lines and a title row as follows.
"# E5080 Limit Test"
"# Revision: 1.00"

TYPE,BEGIN STIMULUS,END STIMULUS,BEGIN RESPONSE,END RESPONSE

Examples `MME:STOR:LIM 'MyFile.csv'`

Query Syntax Not Applicable

Default Not Applicable

MME:STOR:RLIM <file>

Applicable Models: E5080A, M9485A

(Write-only) Saves ripple limit test data into a CSV file.

Parameters

<file> A file path by string format.
 The CSV file shall have header lines and a title row as follows.
 "# E5080 Ripple Limit Test"
 "# Revision: 1.00"
 TYPE,BEGIN STIMULUS,END STIMULUS,MAX RIPPLE

Examples `MME:STOR:RLIM 'MyFile.csv'`

Query Syntax Not Applicable

Default Not Applicable

MME:STOR:TRAC:FORM:SNP <char>

Applicable Models: E5080A, M9485A

(Read-Write) Specifies the format of subsequent .s1p, .s2p, .s3p; s4p save statements. [Learn more.](#)

To save SNP data, use [CALC:DATA:SNP:PORTs:SAVE](#)

Parameters

<char> Choose from:
MA - Linear Magnitude / degrees
DB - Log Magnitude / degrees
RI - Real / Imaginary
AUTO - data is output in currently selected trace format. If other than LogMag, LinMag, or Real/Imag, then output is in Real/Imag.

Examples `MME:STOR:TRAC:FORM:SNP MA`

Query Syntax MME:STOR:TRAC:FORM:SNP?

Return Type Character

Default Auto

MMEMory:TRANSfer <fileName>,<dataBlock>

Applicable Models: E5080A, M9485A

(Read-Write) Transfers data between the VNA and an external controller. Other MMEM commands transfer data between the VNA application and the VNA hard drive. If <fileName> already exists, it will be overwritten. The file must be no larger than 20MB.

To read **trace data** from the VNA in block format, use [CALC:DATA](#).

Parameters

<fileName> String - File name. See [Specifying Path Names](#)

<dataBlock> [Block Data](#) - The contents of the file.

The data block is a block of binary data. Use the following syntax:

#<num digits><byte count><data bytes><NL><END>

where:

<num_digits> specifies how many digits are contained in <byte_count>

<byte_count> specifies how many data bytes will follow in <data bytes>

Example See example program

Query Syntax MMEMory:TRANSfer? <fileName>
Reads block data from the specified file location.

Default Not Applicable

Last modified:

29-Sep-2015 First Release



Output Commands

Controls output functions: RF power and Noise Source.

OUTPut:
[STATe]

Click on a [Red](#) keyword to view the command details.

See Also

- Example Programs
- [Synchronizing the VNA and Controller](#)
- [SCPI Command Tree](#)

OUTPut[:STATe] <bool>

Applicable Models: E5080A, M9485A

(Read-Write) Turns RF power from the source ON or OFF.

[See note about source power state with instrument state save and recall.](#)

Parameters

<bool> **ON** (or 1) - turns RF power ON
OFF (or 0) - turns RF power OFF

Examples

```
OUTP ON
output:state off
```

Query Syntax OUTPut[:STATe]?

Return Type Boolean (1 = ON, 0 = OFF)

Default ON

Last modified:

29-Sep-2015 First Release

Sense**Sense:Average Commands**

Sets sweep-to-sweep averaging parameters. Averaging is a noise reduction technique that averages each data point over a user-specified number of sweeps. Averaging affects all of the measurements in the channel.

SENSE:AVERage

- | [CLEar](#)
- | [COUNT](#)
- | [MODE](#)
- | [\[STATe\]](#)

Click on a [Red](#) keyword to view the command details.

See Also

- Example using some of these commands
- [Learn about Averaging](#)
- [Synchronizing the VNA and Controller](#)
- [SCPI Command Tree](#)

SENSe<cnm>:AVERage:CLEar

Applicable Models: E5080A, M9485A

(Write-only) Clears and restarts averaging of the measurement data. Does NOT apply to point averaging.

Parameters

<cnm> Any existing channel number; if unspecified, value is set to 1.

Examples `SENS:AVER:CLE`
`sense2:average:clear`

Query Syntax Not applicable

Default Not applicable

SENSe<cnm>:AVERage:COUNT <num>

Applicable Models: E5080A, M9485A

(Read-Write) Sets the number of measurements to combine for an average. Must also set [SENS:AVER\[:STAT\]ON](#)

Parameters

- <cnm> Any existing channel number; if unspecified, value is set to 1.
- <num> Number of measurements to average. Choose any number between **1** and **65536** (2^{16}).

Examples `SENS: AVER: COUN 999`
`sense2: average: count 73`

Query Syntax `SENSe<cnm>: AVERage: COUNT?`

Return Type Numeric

Default 1

SENSe<cnm>: AVERage: MODE <char>

Applicable Models: E5080A, M9485A

(Read-Write) Sets the type of averaging to perform: Point or Sweep.

Parameters

- <cnm> Any existing channel number; if unspecified, value is set to 1.
- <char> Averaging Type. Choose from:
POINT - Averaging measurements are made on each data point before stepping to the next data point. (Not available on 'C' models).
SWEEP - Averaging measurements are made on subsequent sweeps until the required number of averaging sweeps are performed.

Examples `SENS: AVER: MODE POIN`
`sense2: average: mode sweep`

Query Syntax `SENSe<cnm>: AVERage: MODE?`

Return Type Character

Default Sweep

SENSe<cnm>: AVERage[: STATE] <bool>

Applicable Models: E5080A, M9485A

(Read-Write) Turns trace averaging ON or OFF.

Parameters

- <cnm> Any existing channel number; if unspecified, value is set to 1.
- <bool> **ON or 1** - Turns averaging ON.

OFF or 0 - Turns averaging OFF.

Examples

```
SENS:AVER ON  
sense2:average:state off
```

Query Syntax

SENSe<cnum>:AVERage[:STATe]?

Return Type

Boolean

Default

OFF

Last modified:

29-Sep-2015 First Release



Sense:Bandwidth Commands

SENSe:BANDwidth | BWIDth:
[\[RESolution\]](#)
[TRACK](#)

Click on a [Red](#) keyword to view the command details.

See Also

- Example Programs
- [Learn about IF Bandwidth](#)
- [Synchronizing the VNA and Controller](#)
- [SCPI Command Tree](#)

SENSe<cnum>:BANDwidth | BWIDth[:RESolution] <num>

Applicable Models: E5080A, M9485A

(Read-Write) Sets the bandwidth of the digital IF filter to be used in the measurement. (Use either **Sense:Bandwidth** or **Sense:Bwidth**)

Parameters

<cnum> Any existing channel number. If unspecified, value is set to 1

<num> IF Bandwidth in Hz. The list of valid IF Bandwidths is different depending on the VNA model. [\(Click to see the lists.\)](#) If an invalid number is specified, the analyzer will round up to the closest valid number.

This parameter supports MIN and MAX as arguments. [Learn more.](#)

Examples

```
SENSe:BWID 1KHZ
sense2:bandwidth:resolution 1000
```

Query Syntax SENSe<cnum>:BANDwidth | BWIDth[:RESolution]?

Return Type Numeric

Default Varies with VNA model.

SENSe<cnum>:BANDwidth | BWIDth:TRACk <bool>

Applicable Models: E5080A, M9485A

(Read-Write) Sets and returns the state of the [Reduce IF BW at Low Frequencies](#) feature. (Use either **Sense:Bandwidth:Track** or **Sense:Bwidth:Track**).

Parameters

<cnum> Any existing channel number. If unspecified, value is set to 1

<bool> Choose from:

ON or **1** - Reduce IF BW at Low Frequencies is set ON.

OFF or **0** - Reduce IF BW at Low Frequencies is set OFF.

Examples

```
SENS:BWID:TRAC OFF  
sense2:bandwidth:track 1
```

Query Syntax SENSE<cnum>:BANDwidth | BWIDth:TRACk?

Return Type Boolean

Default ON

Last Modified:

29-Sep-2015 First Release



Sense:Class Command

**SENSe:CLASs:
NAME?**

Click on a [Red](#) keyword to view the command details.

See Also

- [Learn about Measurement Class](#)
- [Synchronizing the VNA and Controller](#)
- [SCPI Command Tree](#)

SENSe<cnm>:CLASs:NAME?

Applicable Models: E5080A, M9485A

(Read-only) Returns the measurement class name of the specified channel.

Parameters

<cnm> Any existing channel number; if unspecified, value is set to 1.

Examples

```
SENSe:CLASs:NAME?
sense2:class:name?
```

```
For a standard S-Parameter channel, returns...
"Standard"
```

Default Not applicable

Last Modified:

29-Sep-2015 First Release

Correction

Sense:Correction Commands

Performs and applies calibration and other error correction features.

- To perform a Guided Calibration, use ONLY the [Sens:Corr Coll:GUIDed](#) commands.
- To perform an Unguided Calibration, do NOT use the Sens:Corr:Coll:Guided commands.
- See the "Unguided" example programs for clarification.

SENSe:CORRection**CCHeck**| [\[ACQuire\]](#)| **DONE**| [PARAmeter](#)**CKIT - More Commands****COLLect**| [\[ACQuire\]](#)| **APPLy**| [CKIT - More Commands](#)| **DISPlay:WINDow**| **AOFF**| [\[STATe\]](#)| [GUIDed - More Commands](#)| **ISOLation:**| [AVER:INCRement](#)| [ECAL\[:STATe\]](#)| **METHod**| **SAVE**| [SESSion - More Commands](#)| **SWEep:CHANnel**| **AOFF**| [\[STATe\]](#)[CSET - More Commands](#)[EXTension - More Commands](#)**IMPedance:INPut**| **MAGNitude**[INTerpolate\[:STATe\]](#)**ISOLation[:STATe]****METHods:MATCh****PREFeRence**| **CALibration**| [\[FOM:\]RANGe](#)| **CSET**

SAVE
ECAL
ORientation
PMAP
TRIG:FREE
RPOWer:OFFSet
[AMPLitude]
RVELocity
COAX
SFOward
[STATe]
[STATe]
TCOLd:USER:VALue
TStandards
[STATe]
TYPE
CATalog?

Click on a [Red](#) keyword to view the command details.

[Red](#) commands are superseded.

See Also

- [Example Programs](#)
- [See Calibrating the VNA Using SCPI](#)
- [Learn about Measurement Calibration](#)
- [Synchronizing the VNA and Controller](#)
- [SCPI Command Tree](#)

SENSe<cnum>:CORRection:CCHeck[:ACQuire] <mod>[,char]

Applicable Models: E5080A, M9485A

(Write-only) Reads the 'confidence data' associated with the specified ECal module and puts it into memory. The measurement is selected using [SENS:CORR:CCH:PAR](#). This command is compatible with *OPC.

Note: A confidence check can NOT be performed remotely from User Characterizations that are stored on the VNA disk.

Parameters

- <cnum> Any existing channel number. If unspecified, value is set to 1.
- <mod> ECAL Module that contains the confidence data. Choose from:
- ECAL1**
 ..through..
ECAL50

[char] Optional argument. Specifies which characterization within the ECal module that the confidence data will be read from.

CHAR0 Factory characterization (data that was stored in the ECal module by Keysight). Default if not specified.

CHAR1 User characterization #1

CHAR2 User characterization #2

...and so forth up to:

CHAR12 User characterization #12

Examples

```
SENS:CORR:CCHeck ECAL2
sense2:correction:ccheck:acquire ecall,char1
```

Query Syntax Not applicable

Default Not applicable

SENSe<cnum>:CORRection:CCHeck:DONE

Applicable Models: E5080A, M9485A

(Write-only) Concludes the Confidence Check and sets the ECal module back into the idle state.

Parameters

<cnum> Any existing channel number. If unspecified, value is set to 1

Examples

```
SENS:CORR:CCH:DONE
sense2:correction:ccheck:done
```

Query Syntax Not applicable

Default Not applicable

SENSe<cnum>:CORRection:CCHeck:PARAmeter <Mname>

Applicable Models: E5080A, M9485A

(Read-Write) Specifies an existing measurement to be used for the Confidence Check.

Note: A confidence check can NOT be performed remotely from User Characterizations that are stored on the VNA disk.

Parameters

<cnum> Any existing channel number. If unspecified, value is set to 1

<Mname> Name of the measurement you are selecting for the confidence check. The

measurement must already exist.

Examples

```
SENS:CORR:CCH:PAR 'TEST'
'selects the measurement "test" on channel 1 for the
confidence check

sense2:correction:ccheck:parameter 'test'
'selects the measurement "test" on channel 2 for the
confidence check
```

Query Syntax

SENSe<cnum>:CORRection:CCheck:PARAmeter?

Returns the name of the selected measurement on channel <cnum>.

Return Type

String

Default

Not applicable

SENSe<cnum>:CORRection:COLLEct[:ACQuire] <class>[,subclass][,sync]

Applicable Models: E5080A, M9485A

(Write-only) For UNGUIDED calibration, measures the specified standards from the selected calibration kit. The calibration kit is selected using the [Sense:Correction:Collect:CKIT](#) command.

For using two sets of standards, see [SENS:CORR:TST](#).

Note: Before using this command you must select two items:

1. Select a calibration method using [SENS:CORR:COLL:METH](#)
2. Select a measurement using [CALC:PAR:SEL](#). You can select one measurement for each channel.

Parameters

<cnum> Any existing channel number. If unspecified, value is set to 1

<class> **Measures the standards associated with these class labels.** Choose from:

Label	Forward	Reverse
STAN1	S11A	S22A
STAN2	S11B	S22B
STAN3	S11C	S22C
STAN4	S21T	S12T
STAN5	Generic Isolation; not associated with calibration kit definition.	
ECAL1	through ECAL modules	
ECAL50		

RESPonse Same as [Normalize](#) selection in Unguided Cal. (subclass is ignored)

POWER Take a receiver power cal sweep and turn correction ON

SLSET Sets 'sliding load type', and increments the "number of slides" count. The total number of slides is critical to the correct calculation of the sliding load algorithm. See a sliding load cal example.

SLDONE Computes the sliding load using a circle fit algorithm.

[subclass] Optional argument. For mechanical calibration kits, choose from the following to specify the standard to be acquired from the [SENS:CORR:COLL:CKIT:ORDER](#) list. If not specified, subclass is set to **SST1**.

SST1 First standard in the order list

SST2 Second standard in the order list

SST3 Third standard in the order list

SST4 Fourth standard in the order list

SST5 Fifth standard in the order list

SST6 Sixth standard in the order list

SST7 Seventh standard in the order list

If an ECAL module (1 through 8) is specified for <class>, choose one of the following for specifying which characterization within the ECal module will be used for the acquire. If not specified, the default is **CHAR0**.

CHAR0 Factory characterization (data that was stored in the ECal module by Keysight)

CHAR1 User characterization #1

CHAR2 User characterization #2

...and so forth up to:

CHAR12 User characterization #12

[sync] Optional argument. Choose from:

SYNChronous - blocks SCPI commands during standard measurement (default behavior)

ASYNchronous - does NOT block SCPI commands during standard measurement.

[Learn more about this argument](#)

Examples

```
SENS:CORR:COLL STAN1
```

```
'If SENS:CORR:COLL:CKIT:ORDER2 5,3,7
was specified, the following command measures standard 3 (the
second in the order list)
sensel:correction:collect:acquire stan3,sst2
```



```
SENS:CORR:COLL ECAL4,ASYN; *OPC?
sense2:correction:collect:acquire ecal2,char1
```

Query Syntax Not applicable

Default Not applicable

SENSe<cnum>:CORRection:COLLect:APPLy

Applicable Models: E5080A, M9485A

(Write-only) Applies error terms to the measurement that is selected using [Calc:Par:Select](#).

Note: Before using this command you must select a measurement using [CALC:PAR:SEL](#). You can select one measurement for each channel.

Note: This command is only necessary if you need to modify error terms. If you do not need to modify error terms, [SENSe<cnum>:CORRection:COLLect:SAVE](#) calculates and then automatically applies error terms after you use [SENS:CORR:COLL:ACQuire](#) to measure cal standards.

Parameters

<cnum> Any existing channel number. If unspecified, value is set to 1

Example

```
1. CALCulate2:PARAMeter:SElect S21_2 'select the
   measurement to apply terms to
2. SENSe2:CORRection:COLLect:MEthod SPARSOLT 'set type of
   cal method.
3. CALCulate2:DATA? SCORR1 'download the error term of
   interest
4. 'Modify the error term here
5. CALCulate2:DATA SCORR1 'upload the error term of
   interest
6. SENSe2:CORRection:COLLect:APPLy 'applies the error
   terms to the measurement
```

Query Syntax Not applicable

Default Not applicable

SENSe:CORRection:COLLect:DISPlay:WINDow:AOff

Applicable Models: E5080A, M9485A

(Write-only) Clears the flags for windows to be shown during calibrations. To flag a window to be shown see [SENS:CORR:COLL:DISP:WIND](#).

Examples

```
SENS:CORR:COLL:DISP:WIND:AOff
sense:correction:collect:display>window:aoff
See an example using this command.
```

Query Syntax Not Applicable

Default Not Applicable

SENSe:CORRection:COLLect:DISPlay:WINDow<wNum>[:STATe] <bool>

Applicable Models: E5080A, M9485A

(Write-only) Set the 'show' state of the window to be displayed during a calibration. [Learn more](#).

When this command is sent, the specified window is 'flagged' to be shown during calibration. The flag is cleared when the window is closed. A Preset or Instrument State Recall also closes the window. If the same window number is reopened, this command must be sent again to show the window during a calibration. The flag is NOT saved with an instrument state.

Send this command for each additional window to show during a calibration.

Parameters

<wNum> Window number to show during a calibration. The calibration window will also be shown with this window.

The window must already be created.

Use [DISPlay:CATalog?](#) to read all existing window numbers.

<bool> Window state. Choose from:

ON (or 1) - Show the specified window during calibration.

OFF (or 0) - Do NOT show the specified window during calibration.

Examples

```
SENS:CORR:COLL:DISP:WIND1 1
```

```
sense:correction:collect:display:window2:state off
```

See an example using this command.

Query Syntax Not Applicable

Default OFF

SENSe:CORRection:COLLect:ISOLation:AVERage:INCRement <num>

Applicable Models: E5080A, M9485A

(Read-Write) Specifies amount to increment (increase) the channel averaging factor during isolation measurement of the ECal module during an unguided ECal calibration.

Note: if the channel currently has averaging turned OFF and <num> is greater than 1, averaging will be turned ON only during the isolation measurements and with the averaging factor equal to <num>.

Parameters

<num> Incremental Averaging factor. The maximum averaging factor is 65536 (2¹⁶).

Examples `SENS:CORR:COLL:ISOL:AVER:INCR 16`
`sense:correction:collect:isolation:average:increment 0`

Query Syntax `SENSe:CORRection:COLLect:ISOLation:AVERage:INCRement?`

Return Type Numeric

Default 8 - If this command is NOT sent, but [ECal isolation is measured](#), then averaging will be turned ON with factor set to 8 during the isolation measurement.

`SENSe<cnum>:CORRection:COLLect:ISOLation:ECAL[:STATe] <bool>`

Applicable Models: E5080A, M9485A

(Read-Write) Specifies whether or not the isolation state of the ECal module will be measured as part of an unguided ECal calibration.

An unguided calibration is performed using the `SENS:CORR:COLL:METH` and `SENS:CORR:COLL:ACQ` commands.

Note: The inherent isolation of the VNA is better than that attained with this command. ONLY use this command when using an external test set, and ONLY using a 8509x ECal module.

Parameters

- <cnum> Any existing channel number. If unspecified, value is set to 1
- <bool> **ON** (or 1) - isolation is measured during the unguided ECal calibration.
OFF (or 0) isolation is NOT measured during the unguided ECal calibration.

Examples `SENS1:CORR:COLL:ISOL:ECAL ON`
`sense2:correction:collect:isolation:ecal:state 0`

Query Syntax `SENSe:CORRection:COLLect:ISOLation:ECAL:STATe?`

Return Type Boolean (1 = ON, 0 = OFF)

Default OFF

`SENSe<cnum>:CORRection:COLLect:METHod <char>`

Applicable Models: E5080A, M9485A

(Read-Write) For UNGUIDED calibration, sets the calibration method (also known as 'Calibration Type' on calibration dialog box.) To select a Cal Type from a Cal Set, use [CALC:CORR:TYPE](#).

Note: Before using this command you must select a measurement using [CALC:PAR:SEL](#). You can select one measurement for each channel.

Parameters

- <cnum> Any existing channel number. If unspecified, value is set to 1

<char> Choose from:

Method	Description
NONE	No Cal method
REFL1OPEN	Response Open
REFL1SHORT	Response Short
RESPonse	Same as Normalize selection in Unguided Cal.

Examples `SENS:CORR:COLL:METH REFL1SHORT`
`sense2:correction:collect:method response`

Query Syntax `SENSe<cnum>:CORRection:COLLect:METhod?`

Return Type Character

Default Not Applicable

`SENSe<cnum>:CORRection:COLLect:SAVE`

Applicable Models: E5080A, M9485A

(Write-only) For UNGUIDED calibrations ONLY. This command does the following:

- calculates the error terms using the selected :METhod
- applies the error terms to the selected measurement (turns error correction ON.)
- saves the calibration error-terms to the channels Cal Register or a User Cal Set.

The Cal Register or User Cal Set is determined by the setting of the [SENS:CORR:PREFERENCE:CSET:SAVE](#) command.

Do NOT use this command during an ECAL. When performing an ECAL calibration using [SENS:CORR:COLL:ACQUIRE](#), this SAVE operation is performed automatically before the completion of a successful ACQUIRE.

Before using this command you must select a measurement using [CALC:PAR:SEL](#). You can select one measurement for each channel.

Parameters

<cnum> Any existing channel number. If unspecified, value is set to 1

Examples `SENS:CORR:COLL:SAVE`
`sense2:correction:collect:save`

Query Syntax Not applicable

Default Not applicable

`SENSe:CORRection:COLLect:SWEEp:CHANnel:AOff`

Applicable Models: E5080A, M9485A

(Write-only) Clears ALL flags for channels to sweep during calibration. To flag a channel, see [SENS:CORR:COLL:SWE:CHAN](#).

Examples `SENS:CORR:COLL:SWE:CHAN:AOFF`
`sense:correction:collect:sweep:channel:aoff`
 See an example using this command.

Default Not applicable

SENSe<cnum>:CORRection:COLLect:SWEep:CHANnel<cnum2>[:STATe] <bool>

Applicable Models: E5080A, M9485A

(Write-only) Specifies the channel to sweep during a Calibration.

When this command is sent, the <cnum2> channel is 'flagged' to be swept during calibration.

The flag is cleared when the channel is deleted, if the Measurement Class is changed, or if all measurements are deleted from the channel.

If the same channel number is recreated, this command must be sent again to sweep the channel during a calibration. The flag is NOT saved with an instrument state.

A Preset or Instrument State Recall deletes the channel.

Parameters

- <cnum> The channel to be calibrated. If unspecified, value is set to 1.
- <cnum2> The channel to sweep when waiting to measure a standard.
 This channel must already exist with at least one measurement in the channel. If this channel is in continuous sweep mode, it must have the same attenuator settings and path configuration (VNA only).
- <bool> Channel sweep state. Choose from:
ON (or 1) - Sweep the channel during calibration.
OFF (or 0) - Do NOT sweep the channel during calibration.

Examples `SENS:CORR:COLL:SWE:CHAN2 1`
`sense2:correction:collect:sweep:channel3:state off`
 See an example using this command.

Query Syntax Not Applicable

Default OFF

SENSe:CORRection:IMPedance:INPut:MAGNitude <num>

Applicable Models: E5080A, M9485A

(Read-Write) Sets and returns the system impedance value for the analyzer.

Parameters

<num> System Impedance value in ohms. Choose any number between 0 and 1000 ohms.

Examples

```
SENS:CORR:IMP:INP:MAGN 75
sense:correction:impedance:input:magnitude 50.5
```

Query Syntax SENSE:CORRection:IMPedance:INPut:MAGNitude?

Return Type Numeric

Default 50

SENSE<ch>:CORRection:INTerpolate[:STATe] <ON | OFF>

Applicable Models: E5080A, M9485A

(Read-Write) Turns correction interpolation ON or OFF.

Note: Before using this command you must select a measurement using [CALC:PAR:SEL](#). You can select one measurement for each channel.

Parameters

<ch> Any existing channel number. If unspecified, value is set to 1

<ON | OFF> **ON** (or 1) - turns interpolation ON.
OFF (or 0) - turns interpolation OFF.

Examples

```
SENS:CORR:INT ON
sense2:correction:interpolate:state off
```

Query Syntax SENSE<cnum>:CORRection:INTerpolate[:STATe]?

Return Type Boolean (1 = ON, 0 = OFF)

Default ON

SENSE<ch>:CORRection:METhods:MATCh <bool>

Applicable Models: E5080A, M9485A

(Read-Write) Turns match-correction ON or OFF. Use this command AFTER performing an Guided Power Cal. [Learn more.](#)

Parameters

<ch> Channel number on which Guided Power Cal was performed. If unspecified, value is set to 1

<bool> **ON** (or 1) - Turns match-correction ON
OFF (or 0) - Turns match-correction OFF.

Examples `SENS:CORR:METH:MATC 0`
`sense2:correction:methods:match off`

Query Syntax `SENSe<cnnum>:CORRection:METhods:MATCh?`

Return Type Boolean (1 = ON, 0 = OFF)

Default ON

`SENSe:CORRection:PREFeRence:CALibration[:FOM]:RANGe <char>`

Applicable Models: E5080A, M9485A

(Read-Write) Specifies the FOM frequency range to use when performing calibration.

Parameters

<char> Choose from:

PRIMary - Used for calibrating at the mmWave frequencies when NOT using a test set. Learn more.

AUTO - All other calibration situations.

Examples `SENS:CORR:PREF:CAL:RANG PRIM`
`sense:correction:preference:calibration:fom:range auto`

Query Syntax `SENSe:CORRection:PREFeRence:CALibration[:FOM]:RANGe?`

Return Type Character

Default AUTO

`SENSe:CORRection:PREFeRence:CSET:SAVE <char>`

Applicable Models: E5080A, M9485A

Important Notes:

- This command replaces [SENS:CORR:PREF:CSET:SAVU](#)
- With 6.0 we implemented a change that defaults to saving completed calibrations to Cal Registers instead of User Cal Sets. To revert to the old behavior, send this command with the USER argument.

(Read-Write) Specifies the default manner in which calibrations that are performed using SCPI or COM are to be stored. Cal data is ALWAYS stored to the channel Cal Register regardless of this setting.

This setting survives instrument preset and reboot. It remains until changed by another execution of this command.

Note: Cal Set arguments used with commands such as [SENS:CORR:COLL:GUID:INIT](#), [SENS:CORR:COLL:GUID:SAVE](#) and [SENS:CORR:COLL:GUID:SAVE:CSET](#) will override of any of these

default preference settings.

Learn about [Cal Registers and User Cal Sets](#).

Parameters

<char> **CALRegister** - Each Cal is saved ONLY to the channel Cal Register. If the error terms from a new Cal can co-exist with those in the Cal Register, they are appended.

USER - Each Cal is saved to its own new User Cal Set file. The Cal Set name is automatically generated. To change the name, send [SENS:CORR:CSET:NAME](#) after the cal is complete. This reverts to pre-6.0 behavior.

REUSE - The cal is saved to the Cal Set that is currently selected on the specified channel, which could be the channel Cal Register. If the channel does not yet have a selected Cal Set, the cal will be saved to a new User Cal Set with an automatically-generated name. If the error terms from a new Cal can co-exist with those in the Cal Set, they are appended.

Examples

```
SENS:CORR:PREF:CSET:SAVE USER
sense:correction:preference:cset:save reuse
```

Query Syntax SENSE:CORRection:PREFeRence:CSET:SAVE?

Return Type Character

Default CALRegister

SENSe:CORRection:PREFeRence:ECAL:ORientation[:STATe] <ON|OFF>

Applicable Models: E5080A, M9485A

(Read-Write) Specifies whether or not the VNA should perform orientation of the ECal module during calibration. Orientation is a technique by which the VNA automatically determines which ports of the module are connected to which ports of the VNA. Orientation begins to fail at very low power levels or if there is much attenuation in the path between the VNA and the ECal module. If orientation is turned OFF, the [SENS:CORR:PREF:ECAL:PMAP](#) command must be used to specify the port connections before performing a cal.

Note: For 3-port or 4-port measurements, when orientation is OFF, you are not allowed to specify how the ECAL module is connected. Instead, the VNA determines the orientation. Use [SENS:CORR:COLL:GUID:DESC?](#) to query the orientation. The VNA does not verify that you made the connection properly.

This setting remains until the VNA is restarted or this command is sent again.

Parameters

<bool> ECAL orientation state. Choose from:

ON or **1** - VNA performs orientation of the ECal module.

OFF or **0** - VNA does NOT performs orientation of the ECal module.

Examples	<pre>SENS:CORR:PREF:ECAL:ORI OFF sense:correction:preference:ecal:orientation:state on</pre>
Query Syntax	SENSe:CORRection:PREFeRence:ECAL:ORientation[:STATe]?
Return Type	Boolean (1 = ON, 0 = OFF)
Default	ON (1)

SENSe:CORRection:PREFeRence:ECAL:PMAP <module>,<string>

Applicable Models: E5080A, M9485A

(Read-Write) When ECal module orientation is turned OFF ([SENS:CORR:PREF:ECAL:ORI](#)), this command specifies the port mapping (which ports of the module are connected to which ports of the VNA) prior to performing ECal calibrations.

This setting remains until the VNA is restarted or this command is sent again.

Parameters

<module> Specifies which ECal module this port map is being applied to. Choose from:

ECAL1

.through.

ECAL50

<string> Format this parameter in the following manner:

Aw,Bx,Cy,Dz

where

- A, B, C, and D are literal ports on the ECAL module
- w,x,y, and z are substituted for VNA port numbers to which the ECAL module port is connected.

Ports of the module which are not used are omitted from the string.

For example, on a 4-port ECal module with

port A connected to VNA port 2

port B connected to VNA port 3

port C not connected

port D connected to VNA port 1

the string would be: A2,B3,D1

If either the receive port or source port (or load port for 2-port cal) of the CALC:PAR:SElected measurement is not in this string and orientation is OFF, an attempt to perform an ECal calibration will fail.

Examples	<pre>SENS:CORR:PREF:ECAL:PMAP ECAL2, 'A1,B2' sense:correction:preference:ecal:pmap ecal3, 'a2,b1,c3'</pre>
-----------------	--

Query Syntax SENSe:CORRection:PREFeRence:ECAL:PMAP? <module>

Return Type String

Default Null string ()

SENSe:CORRection:PREFErence:TRIG:FREE <char>, <bool>

Applicable Models: E5080A, M9485A

(Read-Write) Sets and returns the preference for the trigger behavior during a calibration. This setting persists until it is changed.

Note: If [TRIGger:SOURce](#) = Manual, during a calibration the VNA ALWAYS switches to Internal for one trigger, then back to Manual, regardless of this preference command.

Parameters

<char> Character - Calibration type. Choose from:

GUIDed - preference setting pertains to a Guided calibration.

UNGuided - preference setting pertains to an Unguided calibration.

<bool> Boolean - Choose from:

0 - OFF - The trigger behavior during the specified calibration type DOES respect the setting of the [TRIGger:SOURce](#) command. For example, when Trigger source = External, the single trigger method will wait for the External trigger signal and then allow only one sweep.

1 - ON - (Pre-6.0 behavior) The trigger behavior during the specified calibration type does NOT respect the setting of the [TRIGger:SOURce](#) command. For example, when Trigger source = External, during calibration the VNA switches to Internal sweep, responds to one trigger signal to measure the standard, then switches back to External.

Examples

```
SENS:CORR:PREF:TRIG:FREE GUID,1
```

```
sense:correction:preference:trig:free unguided,0
```

Query Syntax SENSe:CORRection:PREFErence:TRIG:FREE? <char>

Return Type Boolean

Default OFF for both calibration types.

SENSe<cnum>:CORRection:RPOWEr:OFFSet[:AMPLitude] <num>

Applicable Models: E5080A, M9485A

(Read-Write) Adjusts a receiver power cal to account for components or adapters that are added between the source port and receiver while performing this cal. For more information, see [Receiver Cal](#).

Parameters

- <cnm> Any existing channel number. If unspecified, value is set to 1
- <num> Offset Value in dB. Specify loss as a negative number; and gain as a positive number. Choose a number between -200 and 200.

Examples

```
SENS:CORR:RPOW:OFFS .5
sense2:correction:rpower:offset:amplitude .-5
```

Query Syntax SENSE<cnm>:CORRection:RPOWer:OFFSet[:AMPLitude]?

Return Type Numeric

Default 0

SENSE<cnm>:CORRection:RVELocity:COAX <num>

Applicable Models: E5080A, M9485A

(Read-Write) Sets the velocity factor to be used with Electrical Delay and Port Extensions.

Parameters

- <cnm> Any existing channel number. If unspecified, value is set to 1
- <num> Velocity factor. Choose a number between **0** and **10**
(.66 polyethylene dielectric; .7 PTFE dielectric)

Examples

```
SENS:CORR:RVEL:COAX .66
sense2:correction:rvelocity:coax .70
```

Query Syntax SENSE<cnm>:CORRection:RVELocity:COAX?

Return Type Numeric

Default 1

SENSE<cnm>:CORRection:SFORward[:STATe] <boolean>

Applicable Models: E5080A, M9485A

(Read-Write) Sets the direction a calibration will be performed when only one set of standards is used. Use [SENSE:CORRection:TSTandards\[:STATe\]](#) **OFF** to specify that only one set of standards will be used.

Parameters

- <cnm> Any existing channel number. If unspecified, value is set to 1
- <boolean> **ON (1)** - FORWARD direction of a 2-port calibration will be performed
OFF (0) - REVERSE direction of a 2-port calibration will be performed

Examples

```
SENS:CORR:SFOR 1
sense2:correction:sforward:state 0
See an example using this command
```

Query Syntax SENSE<cnum>:CORRection:SFORward[:STATe]?

Return Type Boolean

Default ON

SENSE<cnum>:CORRection[:STATe] <ON | OFF>

Applicable Models: E5080A, M9485A

(Read-Write) Turns error correction ON and OFF for the specified channel.

Note: Before using this command you must select a measurement using [CALC:PAR:SEL](#). You can select one measurement for each channel.

Parameters

<cnum> Any existing channel number. If unspecified, value is set to 1

<ON | OFF> **ON** (or 1) - correction is applied to the channel.
OFF (or 0) - correction is NOT applied to the channel.

Examples

```
SENS:CORR ON
sense2:correction:state off
```

Query Syntax SENSE<cnum>:CORRection[:STATe]?

To query the error correction state for a measurement, use [CALC:CORR:STATe?](#)

Return Type Boolean (1 = ON, 0 = OFF)

Default OFF

SENSE<cnum>:CORRection:TCOLd:USER:VALue <num>

Applicable Models: E5080A, M9485A

(Read-Write) Sets and returns the temperature of the noise source connector. Learn more about Noise Figure Calibration.

Parameters

<cnum> Any existing channel number. If unspecified, value is set to 1.

<num> Noise source temperature in Kelvin.

Examples

```
SENS:CORR:TCOL:USER:VAL 295
sense2:correction:tcold:user:value 298
```

See an example using this command

Query Syntax SENSE<cnm>:CORRection:TCOLd:USER:VALue?

Return Type Numeric

Default Not Applicable

SENSe<cnm>:CORRection:TSTandards[:STATe] <boolean>

Applicable Models: E5080A, M9485A

(Read-Write) Specifies the acquisition of calibration data using ONE or TWO sets of standards.

Parameters

<cnm> Any existing channel number. If unspecified, value is set to 1.

<boolean> **ON (1)** - TWO identical sets of standards will be used to simultaneously calibrate two ports (for both Forward and Reverse parameters).
OFF (0) - ONE set of standards will be used to perform a full 2-port calibration, one port at a time.

When specifying ON (use two sets), the [SENS:CORR:COLL:ACQuire](#) command uses the same standard index for each calibration class. To specify the calibration standard gender for each port, you must first ensure that the order of calibration class accurately reflects the configuration of your DUT. For example, for a DUT with a male connector on port 1 and a female connector on port 2, order the devices within the S11 classes (A, B, and C) such that the MALE standards are first in the list. Then order the S22 classes specifying the FEMALE standards as the first in the list.

Examples

```
SENS:CORR:TST 1
sense2:correction:tstandard:state 0
See an example using this command
```

Query Syntax SENSE<cnm>:CORRection:TSTandards[:STATe]?

Return Type Boolean

Default ON

SENSe:CORRection:TYPE:CATalog? <char>

Applicable Models: E5080A, M9485A

(Read only) Lists the Cal Types in the VNA by either GUID or registered name. Learn more about applying Cal Type using SCPI.

Note: Before using this command you must select a measurement using [CALC:PAR:SEL](#). You can select one measurement for each channel.

Parameters

<char> (Optional) Specifies the type of list. Choose from:
GUID - the registered GUID of the Cal Type
NAME - the registered name of the Cal Type (Default)

Examples `SENS:CORR:TYPE:CAT? GUID`

Query Syntax `SENSe<cnm>:CORRection:TYPE:CATalog? <char>`

Return Type Comma-separated string

Default Not Applicable

Last modified:

16-Mar-2015 First Release



Sense:Correction:CKIT Commands

Manages the list of cal kits that are installed in the VNA.

SENSe:CORR:CKIT**CLEar****COUNT?****ECAL**| **CHARacterize** **More commands**| **CLISt?**| **DMEMory**| **CLEar**| **IMPort**| **EXPort**| **INFormation**| **KNAME**| **INFormation**| **LIST?**| **ORlent?**| **PATH**| **COUNT?**| **DATA?****EXPort****IMPort****INITialize****LOAD**

- Click on a **Red** keyword to view the command details.
- **New** See Calibrating the VNA Using SCPI
- [Learn about Modifying Cal Kits](#)
- [Synchronizing the VNA and Controller](#)
- [SCPI Command Tree](#)

SENSe:CORRection:CKIT:CLEar[:IMMediate] [ckit]
Applicable Models: E5080A, M9485A

(Write-only) Deletes installed cal kits.

Parameters

[ckit] Optional String. Cal Kit to delete. If not specified, all VNA Cal kits are deleted, including custom kits.

Examples

```
SENS:CORR:CKIT:CLE
sense:correction:ckit:clear:immediate "85052B"
```

Query Syntax Not Applicable

Default Not Applicable

SENSe:CORRection:CKIT:COUnT?

Applicable Models: E5080A, M9485A

(Read-only) Returns the number of installed cal kits.

Examples

```
SENS:CORR:CKIT:COUNT?
```

Query Syntax SENS:CORR:CKIT:COUNT?

Return Type Numeric

Default Not Applicable

SENSe:CORRection:CKIT:ECAL<mod>:CLISt?

Applicable Models: E5080A, M9485A

(Read-only) Returns a list of characterizations stored in the specified ECal module.

Parameters

<mod> ECal module from which to read user characterization numbers. Choose from 1 to 50. If unspecified, value is set to 1.

Examples

```
Module 1 contains User Characterizations 1 and 3.
SENSe:CORRection:CKIT:ECAL:CLISt?
'Returns the following (0 always indicates the factory
characterization):
0,1,3
```

Return Type Numeric list, separated by commas.

Default Not Applicable

SENSe:CORRection:CKIT:ECAL:DMEMory:CLEar <kitName>

Applicable Models: E5080A, M9485A

(Write-only) Deletes user characterizations from VNA disk memory.

Parameters

<kitName> Optional String argument. ECal Model, User Characterization name + " ECal", and serial number of the ECal module, separated by spaces. See examples below.

If unspecified, ALL User Characterizations that are stored in VNA disk memory are deleted.

Examples

```
'These examples all use "MyUserChar" as the User
characterization name.

'The "My User Char" characterization is deleted from disk
memory.

SENS:CORR:CKIT:ECAL:DMEM:CLE "N4433A MyUserChar ECal 00001"

'All User characterizations are deleted from disk memory.

SENS:CORR:CKIT:ECAL:DMEM:CLE
```

Query Syntax Not Applicable

Default Not Applicable

SENSe:CORRection:CKIT:ECAL:DMEMory:IMPort <file>

Applicable Models: E5080A, M9485A

(Write-only) After the VNA disk memory is [Exported](#) to a file, use this command to Import the file into VNA disk memory, which allows the User Characterization to be used with the VNA and ECal module.

Note: An ECal confidence check can NOT be performed remotely from User Characterizations that are stored on the VNA disk.

Parameters

<file> String. Full path and file name of file that was exported.

Examples

```
SENS:CORR:CKIT:ECAL:DMEM:IMP "c:\users\public\network
analyzer\ECal User Characterizations/myDiskUserChar.euc"
```

Query Syntax Not Applicable

Default Not Applicable

SENSe:CORRection:CKIT:ECAL:EXPort <kit>[,<file>][,<NewName>]]

Applicable Models: E5080A, M9485A

(Write-only) Saves an existing ECal characterization to a file. Use this command to archive the user characterization or to move the characterization to a different VNA for use with the specified ECal

module. After exporting the user characterization, use [SENS:CORR:CKIT:ECAL:DMEM:IMPORt](#) to make the user characterization available for use.

Parameters

- <kit> String. Not case sensitive. ECal Model, User char name + " ECal", and serial number of the ECal module used for the characterization, separated by spaces. See examples below.
- If the model and serial number of the module is not found, an error is returned.
- [<file>] Optional String argument. Path and filename of the user characterization. If not specified, the file is saved using characterization name + ".euc". If the path is not specified, it is stored in C:/Program Files/Keysight/Network Analyzer/ECal User Characterizations/. The extension ".euc" is appended if one is not specified.
- [<NewName>] Optional String argument. This allows you to change the name for the User Characterization. When specified, the new name is saved in the file with the characterization. If unspecified, the existing user characterization name is saved.

Note: If this argument is specified, the second argument (<file>) must also be specified.

Examples

```
'These examples all use "MyUserChar" as the User
characterization name.
'All parameters specified
SENS:CORR:CKIT:ECAL:EXP "N4433A MyUserChar ECal
00001", "myUserChar.euc", "NewUserChar"
'First two parameters are specified
sense:correction:ckit:ecal:export "N4691B MyUserChar ECal
00500", "myUserChar.euc"
'Only first parameter is specified
SENS:CORR:CKIT:ECAL:EXP "N4433A MyUserChar ECal 00001"
```

Query Syntax Not Applicable

Default Not Applicable

SENSe:CORRection:CKIT:ECAL<mod>:INFormation? [<char>]

Applicable Models: E5080A, M9485A

(Read-only) Reads the identification and characterization information from the specified ECal module.

Note: To read user-characterization information that is stored in VNA disk memory, then use [SENS:CORR:CKIT:ECAL:KNAM:INF?](#)

Parameters

- <mod> ECal module from which to read characterizations. Choose from 1 through 50. If unspecified, value is set to 1.
- Do NOT assume the <mod> number is the order in which ECal modules were

connected.

Use [SENS:CORR:CKIT:ECAL:LIST?](#) to read a list of <mod> numbers of currently-attached ECal modules.

<char> Optional argument. Specifies which characterization to read information from. If not specified, value is set to CHAR0.

Choose from:

- CHAR0 Factory characterization (data that was stored in the ECal module by Keysight)
- CHAR1 User characterization #1
- CHAR2 User characterization #2
- - through -
- CHAR12 User characterization #12

Examples

```
SENS:CORR:CKIT:ECAL2:INformation? char5
```

'Example return string:

```
"ModelNumber: 85092-60007, SerialNumber: 01386,
ConnectorType: N5FN5F, PortAConnector: Type N (50) female,
PortBConnector: Type N (50) female, MinFreq: 30000, MaxFreq:
9100000000, NumberOfPoints: 250, Calibrated: July 4 2002"
```

Return Type Character

Default Not Applicable

SENSE:CORRection:CKIT:ECAL:KNAME:INformation? <kitName>

Applicable Models: E5080A, M9485A

(Read-only) Reads the identification and characterization information from the specified ECal module or VNA disk memory.

[Learn more about User Characterization in VNA Disk Memory.](#)

Parameters

<kitName> String. ECal model and characterization to read information from, enclosed in quotes, in the following format:

<model> <name> **E**Cal <serial number>

Where:

<model>: Always required

<name>:

- For the factory characterization, do not specify.
- For a user-characterization stored in the module, use **User <n>** in the string, where <n> is the user-characterization number. Not case sensitive. Separate User and <n> with a space.
- For a user-characterization stored in VNA disk memory, use

<charName> from SENS:CORR:CKIT:ECAL:CHAR:DMEM:SAVE
<charName>

ECal - not case sensitive

<serial number>: Optional. Include when two or more ECal modules with same model number are attached to the VNA,

Each item is separated with a space.

Examples

```
'For a factory characterization in module memory:
SENS:CORR:CKIT:ECAL:KNAM:INF? "N4433A ECal"

'For user characterization in module memory with optional
serial number:
SENS:CORR:CKIT:ECAL:KNAM:INF? "N4433A User 1 ECal 00028"

'For user characterization "foo" in disk memory:
SENS:CORR:CKIT:ECAL:KNAM:INF? "N4433A foo ECal 00028"

'Example return string:

"ModelNumber: N4433A, SerialNumber: 00028, ConnectorType:
N5FN5F, PortAConnector: Type N (50) female, PortBConnector:
Type N (50) female, MinFreq: 30000, MaxFreq: 9100000000,
NumberOfPoints: 250, Calibrated: July 4 2002"
```

Return Type String

Default Not Applicable

SENSe:CORRection:CKIT:ECAL:LIST?

Applicable Models: E5080A, M9485A

(Read-only) Returns a list of index numbers for ECal modules that are currently attached to the VNA. Use these numbers to refer to the ECal module using SCPI commands.

Examples

```
SENS:CORR:CKIT:ECAL:LIST?

'If 2 modules are attached to the VNA
'then the returned list will be:
+1,+2

'If NO modules are attached to the VNA
'then the returned list will be:
+0

See example program using this command.
```

Return Type Numeric list, separated by commas.

Default Not Applicable

SENSe<ch>:CORRection:CKIT:ECAL<n>:ORient? <vPort>[,<charN>]

Applicable Models: E5080A, M9485A

(Read-only) Returns the ECal port that is connected to the specified VNA port. A calibration does not have to be in process.

<ch> Channel number that contains the frequency range to be calibrated.

<n> ECal module number. Choose from 1 through 50.

If unspecified (only one ECal module is connected to the USB), <n> is set to 1. If two or more modules are connected, use [SENS:CORR:CKIT:ECAL:LIST?](#) to determine how many, and [SENS:CORR:CKIT:ECAL:INF?](#) to verify their identities.

<pnaPort> VNA port number.

<charN> Optional argument. If unspecified, factory data (CHAR0) is used. User Characterization number that matches the physical adapters/fixtures that are on the ECal module. This aids in determining the orientation of the ECal module.

Choose from:

- **CHAR0** Factory characterization (data that was stored in the ECal module by Keysight)
 - **CHAR1** User characterization #1
 - **CHAR2** User characterization #2
- and so forth up to:
- **CHAR12** User characterization #12

Examples

```
SENS1:CORR:CKIT:ECAL1:ORI? 2
sense2:correction:ckit,ecal1:orient? 2, char2
```

Return Type

The returned ECal port number is a 1-based number: 1 = Port A, 2 = Port B, 3 = Port C, 4 = Port D.

Zero (0) is returned when the auto-orientation routine is unable to resolve the orientation.

Default Not Applicable

SENSe:CORRection:CKIT:ECAL<n>:PATH:COUNT? <path>

Applicable Models: E5080A, M9485A

(Read-only) Returns the number of unique states that exist for the specified path name on the selected ECal module.

This command performs exactly the same function as [CONT:ECAL:MOD:PATH:COUNT?](#)

Use the [CONT:ECAL:MOD:PATH:STAT](#) command to set the module into one of those states.

Use [SENS:CORR:CKIT:ECAL:PATH:DATA?](#) to read the data for a state.

Parameters

<n> USB number of the ECal module. Choose from 1 to 50.

If unspecified (only one ECal module is connected to the USB), <n> is set to 1. If two or more modules are connected, use [SENS:CORR:CKIT:ECAL:LIST?](#) to determine how many, and [SENS:CORR:CKIT:ECAL:INF?](#) to verify their identities.

<path> Name of the path for which to read number of states. Choose from:

Reflection paths

- **A**
- **B**
- **C** (4-port modules)
- **D** (4-port modules)

Transmission paths

- **AB**
- **AC** (4-port modules)
- **AD** (4-port modules)
- **BC** (4-port modules)
- **BD** (4-port modules)
- **CD** (4-port modules)

Examples

```
CONT:ECAL:MOD:PATH:COUNT?
control:ecal:module2:path:count?
```

Return Type Integer

Default Not Applicable

SENSe<ch>:CORRection:CKIT:ECAL<num>:PATH:DATA? <path>, <stateNum>[,<char>]

Applicable Models: E5080A, M9485A

(Read-only) Returns the data for a state from the memory of the selected ECal module. The returned data is interpolated if necessary to have the same stimulus values as the specified channel <ch>.

- For a reflection path state, the data is reflection S-parameter data. The number of values equals the number of stimulus points on the channel multiplied by 2 (because they are complex numbers).
- For a transmission path state, the data is all 4 S-parameters of the state. The number of values returned is 4 times that of a reflection state.

The data is returned in the same format as [CALC:DATA:SNP?](#)

Note: This command returns SNP data without header information, and in columns, not in rows as .SnP files. This means that the data returned from this command sends all frequency data, then all Sx1 magnitude or real data, then all Sx1 phase or imaginary data, and so forth.

Parameters

<ch> Any existing channel number. If unspecified, value is set to 1.

<num> Optional argument. USB number of the ECal module. Choose from 1 through 50.
If unspecified (only one ECal module is connected to the USB), <num> is set to 1.
If two or more modules are connected, use [SENS:CORR:CKIT:ECAL:LIST?](#) to determine how many, and [SENS:CORR:CKIT:ECAL:INF?](#) to verify their identities.

<path> Name of the path for which to read number of states. Choose from:

Reflection paths

- **A**
- **B**
- **C** (4-port modules)
- **D** (4-port modules)

Transmission paths

- **AB**
- **AC** (4-port modules)
- **AD** (4-port modules)
- **BC** (4-port modules)
- **BD** (4-port modules)
- **CD** (4-port modules)

<stateNum> Number of the state to set. Refer to the following table to associate the <stateNum> with a state in your ECal module.

In addition, [CONT:ECAL:MOD:PATH:COUNT?](#) returns the number of states in the specified ECal module.

<stateNum>	N4432A and N4433A States	N4431A States	N469x States**	8509x States
One-Port Reflection States				
1	Open	Open	Impedance 1	Open
2	Short	Short	Impedance 2	Short
3	Impedance 1	Impedance 1	Impedance 3	Impedance 1
4	Impedance 2	Impedance 2	Impedance 4	Impedance 2
5			Impedance	

			5	
6			Impedance 6	
7			Impedance 7	
Two-Port Transmission States				
1	Thru	Thru	Thru	Thru
2	Confidence	Confidence	Confidence	Confidence

** The following modules have only FOUR Impedance states (1, 2, 3, 4): N4690B ,N4691B ,N4692A ,N4696B.

<char> Optional argument. Specifies which characterization within the ECal module to read information from. If not specified, value is set to CHAR0.

Choose from:

- **CHAR0** Factory characterization (data that was stored in the ECal module by Keysight)
 - **CHAR1** User characterization #1
 - **CHAR2** User characterization #2
- and so forth up to:
- **CHAR12** User characterization #12

Examples `SENS:CORR:CKIT:ECAL1:PATH:DATA? A,1`

Return Type S1P or S2P

Default Not Applicable

SENSe:CORRection:CKIT:EXPort <kit>[,<file>]

Applicable Models: E5080A, M9485A

(Write-only) Saves an existing cal kit definitions to a file. Use this command to archive or move a user-defined or modified cal kit to a different VNA. After exporting the cal kit, use [SENS:CORR:CKIT:IMPORt](#) to make the cal kit available for use on the VNA. This command provides the same behavior as the Installed Kits - Save As button on the [Edit VNA Cal Kits](#) dialog.

Parameters

<kit> String. Not case sensitive. Name of the cal kit to export, as seen in the Cal Kits field of the [Select DUT Connectors and Cal Kits](#) dialog of a SMART Cal.

<file> Optional String argument. Path and filename to where the Cal Kit file is to be saved. If not specified, the file is saved using <kit> + ".ckt". If the path is not specified, it is stored in C:/Program Files/Keysight/Network

Analyzer/PNACalKits/User.

Examples

```
'File unspecified
SENS:CORR:CKIT:EXP "MyCalKit"
'Both parameters are specified
sense:correction:ckit:export
"MyCalKit", "C:/myBackupCalKit.ckt"
```

Query Syntax Not Applicable

Default Not Applicable

SENSe:CORRection:CKIT:IMPort <string>

Applicable Models: E5080A, M9485A

(Write-only) Imports the specified cal kit (.ckt file) and appends the imported kit to the end of the list of kits.

Note: Although there is no limit to the number of cal kits that can be imported, during an [Unguided cal](#), you can access ONLY mechanical cal kits #1 through #95.

Parameters

<string> Path and cal kit name.

Examples

```
SENSe:CORRection:CKIT:IMPort "c:\users\public\network
analyzer\documents\85033D.ckt"
```

Query Syntax Not Applicable

Default Not Applicable

SENSe:CORRection:CKIT:INITialize[:IMMEDIATE] [ckit]

Applicable Models: E5080A, M9485A

(Write-only) Restores default factory installed cal kits. This command also selects kit number 1, as you would using [SENS:CORR:COLL:CKIT:SEL 1](#). Therefore, if you intend to work with a Cal Kit remotely, select the Cal Kit **AFTER** sending this command.

Note: This command can also delete all existing User-defined Cal Kits. However, if saved using Save As, these kits can be restored in the same manner as after a VNA firmware upgrade. [Learn more about saving modified Cal Kits.](#)

Parameters

[ckit] Optional String. Cal Kit to restore. If not specified, all VNA factory Cal kits are restored.

Examples

```
SENS:CORR:CKIT:INITialize
```

```
sense:correction:ckit:initialize:immediate "85052B"
```

Query Syntax Not Applicable

Default Not Applicable

SENSe:CORRection:CKIT:LOAD <string>

Applicable Models: E5080A, M9485A

(Write-only) Loads the specified collection of cal kits from a .wks file. You can make your own collection of cal kits from the [Advanced Modify Cal Kit](#) menu.

Parameters

<string> Path and file name of the cal kit collection.

Examples

```
sense:correction:ckit:load "C:/Program
Files/Keysight/Network
Analyzer/PnaCalKits/factory/wMyCalKits.wks"
```

Query Syntax Not Applicable

Default Not Applicable

Last modified:

16-Mar-2015 First Release

Sense:Correction:Collect:Ckit Commands

Use to change the definitions of calibration kit standards.

SENSe:CORRection:COLLect:CKIT:

- | **CATalog?**
- | **CONNector**
 - | **ADD**
 - | **CATalog?**
 - | **DELeTe**
 - | **FNAME**
 - | **SNAME**
- | **DESCRiption**
- | **INFORMATION?**
- | **NAME**
- | **OLAB**
- | **OLISt?**
- | **ORDer**
- | **PORT[:SELEct]**

- | **SELEct**
- | **STANdard**
 - | **CO, C1, C2, C3**
 - | **CHARacter**
 - | **DELay**
 - | **FMAX**
 - | **FMIN**
 - | **IMPedance**
 - | **LO, L1, L2, L3**
 - | **LABel**
 - | **LOSS**
 - | **REMOve**
 - | **SDESCRIPTION**
 - | **[SELEct]**
 - | **TYPE**
 - | **TZReal**
 - | **TZImag**

TRLOption IMPedance RPLane
--

Click on a [blue](#) keyword to view the command details.

Most of these commands act on the currently selected standard from the currently selected calibration kit.

- To select a Calibration kit, use [SENS:CORR:COLL:CKIT:SEL](#).
- To select a Calibration standard, use [SENS:CORR:COLL:CKIT:STAN:SEL](#)
- See an **example** program that CREATES a New Cal Kit
- See an **example** program that MODIFIES an Existing Cal Kit
- [Learn about Modifying Cal Kits](#)
- [Synchronizing the VNA and Controller](#)
- [SCPI Command Tree](#)

Note: You should provide data for every definition field - for every standard in your calibration kit. If a field is not set, the default value may not be what you expect.

For more information, read [Specifying Calibration Standards and Kits for Keysight Vector Network Analyzers \(Application Note 1287-11\)](#)

SENSe:CORRection:COLLect:CKIT:CATalog?

Applicable Models: E5080A, M9485A

(Read-only) Returns the names of the first 50 mechanical cal kits in your VNA that can be used for unguided calibrations.

Examples `SENS:CORR:COLL:CKIT:CAT?`

Return Type A comma-separated string

Default Not Applicable

SENSe:CORRection:COLLect:CKIT:CONNector:ADD
<family>,<start>,<stop>,<z0>,<gender>,<media>,<cutoff>

Applicable Models: E5080A, M9485A

(Write only) Creates a new connector. The connector is automatically added to the list of available connectors for the currently selected cal kit. If a connector includes both male and female connectors, each connector must be added separately.

Parameters

<family> (String) Name of connector family. Limited to 50 characters.

<start> Start frequency

<stop>	Stop frequency
<z0>	Characteristic Impedance of the connector in ohms.
<gender>	Connector gender. Choose from: MALE FEMALE NONE
<media>	Media of the connector. Choose from: COAX - coaxial WAVE - waveguide
<cutoff>	Cutoff frequency of the connector (waveguide only).

Examples

```
SENS:CORR:COLL:CKIT:CONN:ADD "PSC 1.8 mm",0 HZ,999.9
GHZ,50,FEMALE,COAX,0.0
SENS:CORR:COLL:CKIT:CONN:ADD "PSC 1.8 mm",0 HZ,999.9
GHZ,50,MALE,COAX,0.0
```

Query Syntax Not applicable

Default Not Applicable

SENSe:CORRection:COLLect:CKIT:CONNector:CATalog?

Applicable Models: E5080A, M9485A

(Read-only) Returns a comma-separated list of all connectors defined within the currently selected cal kit. The returned string includes the connector family name followed by the connector gender, if any. Kits may include a primary connector family name and additional connector family names.

Connector family names are case sensitive. A connector family named "PSC 2.4" is different from a connector family named "psc 2.4".

Learn more about [Connector Family Name](#).

Examples

```
SENS:CORR:COLL:CKIT:CONN:CAT?
'Returned string
"Type-N (50) male, Type-N (50) female"
```

Default Not Applicable

SENSe:CORRection:COLLect:CKIT:CONNector:DELeTe

Applicable Models: E5080A, M9485A

(Write-only) Deletes the primary connector family name from the selected kit. The VNA allows multiple connector families for each kit. If a kit includes multiple connector families, only the first listed (primary) connector family name is deleted.

Once the connector family is deleted, the connector may not be assigned to any new or existing standard within the kit.

The previously defined standards retain their association to the deleted connector name. To reassign

standards to a new connector family name, use [SENS:CORR:COLL:CKIT:CONN:SNAME](#).

Examples `SENS:CORR:COLL:CKIT:CONN:DEL`

Query Syntax Not Applicable

Default Not Applicable

SENSe:CORRection:COLLect:CKIT:CONNector:FNAME <name>

Applicable Models: E5080A, M9485A

(Read-Write) Replaces the primary connector family name from the selected kit with a new connector family name. The connector family name is replaced in all standards in the kit that share that name. The VNA allows multiple connector families for each kit. If a kit includes multiple connector families, only the first listed (primary) connector family name is replaced. Use the query form of this command to return the name of the primary connector family.

Parameters

<name> New connector family name. Limited to 50 characters.

Examples `SENS:CORR:COLL:CKIT:CONN:FNAME 'MYPSC35'`
`Sense:correction:collect:ckit:connector:name 'My Type N'`

Query Syntax SENSe:CORRection:COLLect:CKIT:CONNector:FNAME?

Return Type String

Default Not Applicable

SENSe:CORRection:COLLect:CKIT:CONNector:SNAME <family>,<gender>,<port>

Applicable Models: E5080A, M9485A

(Read-Write) Assigns a family name to the currently selected standard from the currently selected kit. Specify each port of a 2-port standard individually. Use the query form of this command to read the connector family name assigned to the current standard. The name is not assigned unless the connector family name is previously defined within the selected kit.

Parameters

<family> String. Connector family name.

<gender> Connector gender. Choose from:
 MALE
 FEMALE
 NONE

<port> Number of the connector port to be assigned the connector family name. 2-port standards such as a thru line must be assigned separately. It is not relevant which connector is port 1 or port 2.

1 Specifies a 1-port standard or the first port of a 2-port standard.

2 Specifies the second port of a 2-port standard.

Examples `SENS:CORR:COLL:CKIT:CONN:SNAME "Type-N (50)",MALE,1`

Query Syntax `SENSe:CORRection:COLLect:CKIT:CONNector:SNAME?`

Return Type String

Default Not Applicable

`SENSe:CORRection:COLLect:CKIT:DESCription <string>`

Applicable Models: E5080A, M9485A

(Read-Write) Modifies the cal kit description field of the selected kit. This description appears in the [Edit VNA Cal Kit dialog box](#).

Parameters

<string> Description of the cal kit. Limited to 50 characters.

Examples `SENS:CORR:COLL:CKIT:DESC "My New CalKit"`

Query Syntax `SENSe:CORRection:COLLect:CKIT:DESCription?`

Return Type String

Default Not Applicable

`SENSe:CORRection:COLLect:CKIT:INFormation? <module>[,char]`

Applicable Models: E5080A, M9485A

(Read Only) Reads characterization information from an ECal module.

Parameters

<module> Specifies which ECal module to read from. Choose from:

ECAL1

.through.

ECAL50

[char] Optional argument.

Specifies which characterization within the ECal module to read information from. If this argument is not used, the default is **CHAR0**. **CHAR1** through **CHAR5** are for user characterizations that may have been written to the module by the User Characterization feature on the VNA. Choose from:

CHAR0 Factory characterization (data that was stored in the ECal module by Keysight)

CHAR1 User characterization #1

CHAR2 User characterization #2

- through -

CHAR12 User characterization #12

Examples

```
SENS:CORR:COLL:CKIT:INF? ECAL4
sense:correction:collect:ckit:information? ecal2,char1
```

Example return string:

```
ModelNumber: 85092-60007, SerialNumber: 01386,
ConnectorType: N5FN5F, PortAConnector: Type N (50) female,
PortBConnector: Type N (50) female, MinFreq: 30000, MaxFreq:
9100000000, NumberOfPoints: 250, Calibrated: July 4 2002
```

Return Type Character

Default Not Applicable

SENSe:CORRection:COLLect:CKIT:NAME <name>

Applicable Models: E5080A, M9485A

(Read-Write) Sets a name for the selected calibration kit.

Parameters

<name> Calibration Kit name. Any string name, can include numerics, period, and spaces; any length (although the dialog box display is limited to about 30 characters).

Examples

```
SENS:CORR:COLL:CKIT:NAME 'MYAPC35'
sense:correction:collect:ckit:name 'mytypen'
```

Query Syntax SENSe:CORRection:COLLect:CKIT:NAME?

Return Type String

Default Not Applicable

SENSe:CORRection:COLLect:CKIT:OLABel<class> <name>

Applicable Models: E5080A, M9485A

(Read-Write) Sets the label for the calibration class designated by <class>. The label is used in the prompts for connecting the calibration standards associated with that <class>.

Parameters

<class> Number of the calibration class. Choose a number between: 1 and 18. The <class> numbers are associated with the following calibration Classes:

	Class	Description
1	S11A	Reflection standard

2	S11B	Reflection standard
3	S11C	Reflection standard
4	S21T	Thru/Delay standard
5	S22A	Reflection standard
6	S22B	Reflection standard
7	S22C	Reflection standard
8	S12T	Thru/Delay standard

3-port analyzers only

9	S33A	Reflection standard
10	S33B	Reflection standard
11	S33C	Reflection standard
12	S32T	Thru/Delay standard
13	S23T	Thru/Delay standard
14	S31T	Thru/Delay standard
15	S13T	Thru/Delay standard

TRL Calibrations

16	TRL "T"	Thru standard
17	TRL "R"	Reflect standard
18	TRL "L"	Line standard

<name> Label for the calibration class. Must be enclosed in quotes. Any string between 1 and 12 characters long. Cannot begin with a numeric.

Examples

```
SENS:CORR:COLL:CKIT:OLAB3 'LOADS'
sense:correction:collect:ckit:olabel14 'Thru'
```

Return Type String

Default Not Applicable

SENSe:CORRection:COLLect:CKIT:OLIST[class]?

Applicable Models: E5080A, M9485A

(Read-only) Returns seven values of standards that are assigned to the specified class.

This command ALWAYS applies to the Cal Kit that is selected (using [SENS:CORR:COLL:CKIT:SEL](#)) when this ORDER command is sent.

Parameters

<class> Number of the calibration class to be queried. The <class> numbers are associated with the following calibration Classes:

	Class	Description
1	S11A	Reflection standard
2	S11B	Reflection standard
3	S11C	Reflection standard
4	S21T	Thru/Delay standard
5	S22A	Reflection standard
6	S22B	Reflection standard
7	S22C	Reflection standard
8	S12T	Thru/Delay standard

3-port analyzers ONLY

4-port analyzers use S11 and S22 classes (see example program)

9	S33A	Reflection standard
10	S33B	Reflection standard
11	S33C	Reflection standard
12	S32T	Thru/Delay standard
13	S23T	Thru/Delay standard
14	S31T	Thru/Delay standard
15	S13T	Thru/Delay standard

TRL Calibrations

16	TRL "T"	Thru standard
17	TRL "R"	Reflect standard
18	TRL "L"	Thru standard

Examples

```
SENS:CORR:COLL:CKIT:OLIST8?
```

Always returns 7 standard numbers. Unassigned standards return 0

Return Type

Numeric; returns the <class> number of the selected standard.

Default

Not Applicable

SENSe:CORRection:COLLect:CKIT:ORDeR<class> <std> [,<std>] [,<std>] [,<std>] [,<std>] [,<std>]
[,<std>]

Applicable Models: E5080A, M9485A

(Read-Write) Sets a standard number to a calibration class. This command does **NOT** set or dictate the order for measuring the standards. For more information, see Assigning Standards to a Calibration Class.

This command ALWAYS applies to the Cal Kit that is selected (using [SENS:CORR:COLL:CKIT:SEL](#)) when this ORDER command is sent.

Parameters

<class> Number of the calibration class that is assigned to <standard>. Choose a number between: **1** and **18**. The <class> numbers are associated with the following calibration Classes:

	Class	Description
1	S11A	Reflection standard
2	S11B	Reflection standard
3	S11C	Reflection standard
4	S21T	Thru/Delay standard
5	S22A	Reflection standard
6	S22B	Reflection standard
7	S22C	Reflection standard
8	S12T	Thru/Delay standard

3-port analyzers ONLY

4-port analyzers use S11 and S22 classes (see example program)

9	S33A	Reflection standard
10	S33B	Reflection standard
11	S33C	Reflection standard
12	S32T	Thru/Delay standard
13	S23T	Thru/Delay standard
14	S31T	Thru/Delay standard
15	S13T	Thru/Delay standard

TRL Calibration

16	TRL "T"	Thru standard
17	TRL "R"	Reflect standard
18	TRL "L"	Line standard

<std> Standard number to be assigned to the class; Choose a standard between 1 and 30. One standard is mandatory; up to six additional standards are optional.

Examples

```
'Assigns standard 3 to S11A class:
SENS:CORR:COLL:CKIT:ORD1 3
'Assigns standard 2 and 5 to S21T class class:
```

```
sense:correction:collect:ckit:order4 2,5
```

Query Syntax	SENSe:CORRection:COLLect:CKIT:ORDeR<class>? 'Returns only the first standard assigned to the specified class. To query the remaining standards, use SENSe:CORRection:COLLect:CKIT:OLIST[1-15]?
Return Type	Numeric
Default	Not Applicable

SENSe<cnum>:CORRection:COLLect:CKIT:PORT<n>[:SELeCt] <string>

Applicable Models: E5080A, M9485A

(Read-Write) Sets and returns the name of the Cal Kit to use for **Unguided** cal.

This command effectively does the same task as [SENS:CORR:COLL:CKIT](#) but specifies the cal kit by name.

Note: During an [Unguided cal](#), you can access ONLY mechanical cal kits #1 through #95. However, there is no limit to the number of cal kits that can be imported.

Parameters

- <cnum> Currently not used. The unguided cal kit selection is for all ports on all channels.
- <n> Currently not used. The unguided cal kit selection is for all ports on all channels.
- <string> Cal Kit name enclosed in quotes. Use [SENS:CORR:COLL:CKIT:CAT?](#) to read a list of all available Cal Kits in the VNA.

Examples

```
SENS:CORR:COLL:CKIT:PORT "85052B"  
sense2:correction:collect:ckit:port:select "85052D"
```

Query Syntax SENSe<cnum>:CORRection:COLLect:CKIT:PORT<n>:SELECT?

Return Type String

Default Last kit selected

SENSe<cnum>:CORRection:COLLect:CKIT[:SELeCt] <num>

Applicable Models: E5080A, M9485A

(Read-Write) Selects (makes active) a calibration kit for **performing** an **UNGUIDED** calibration or for **modifying** standards. All subsequent "CKIT" commands that are sent apply to this selected calibration kit. Select a calibration standard using [SENS:CORR:COLL:CKIT:STAN <num>](#). Kits 1 to approximately kit 37 are factory installed Cal Kits.

Note: During an [Unguided cal](#), you can access ONLY mechanical cal kits #1 through #95. However, there is no limit to the number of cal kits that can be imported.

This command effectively does the same task as [SENS:CORR:COLL:CKIT:PORT](#) which specifies the cal kit by name instead of this command which specifies by number.

Parameters

- <num> Any existing channel number; if unspecified, value is set to 1.
- <num> The number of the calibration kit. Choose from:
Use [SENSe:CORRection:COLLect:CKIT:RESet](#) to restore Cal Kits to default values.

Name

- | | |
|----|-------------|
| 1 | Cal Kit 1 |
| 2 | Cal Kit 2 |
| 3 | Cal Kit 3 |
| | " |
| | " |
| 94 | Cal Kit 94 |
| 95 | Cal Kit 95 |
| 99 | ECal module |

Examples `SENS:CORR:COLL:CKIT 2`
`sense2:correction:collect:ckit:select 7`

Query Syntax `SENSe<num>:CORRection:COLLect:CKIT?`

Return Type Numeric

Default Last kit selected

`SENSe:CORRection:COLLect:CKIT:STANdard:C0 <num>`

Applicable Models: E5080A, M9485A

(Read-Write) Sets the C0 value (the first capacitance value) for the selected standard. For a detailed discussion of this value, search for App Note 8510-5B at www.Keysight.com.

Parameters

- <num> Value for C0 in femtofarads (1E-15)

Examples **The following commands set C0=15 femtofarads:**
`SENS:CORR:COLL:CKIT:STAN:C0 15`
`sense:correction:collect:ckit:standard:c0 15`

Query Syntax `SENSe:CORRection:COLLect:CKIT:STANdard:C0?`

Return Type Numeric

Default Not Applicable

SENSe:CORRection:COLLect:CKIT:STANdard:C1 <num>

Applicable Models: E5080A, M9485A

(Read-Write) Sets the C1 value (the second capacitance value) for the selected standard. For a detailed discussion of this value, search for App Note 8510-5B at www.Keysight.com.

Parameters

<num> Value for C1.

Examples

The following two commands set C1=15:

```
SENS:CORR:COLL:CKIT:STAN:C1 15
sense:correction:collect:ckit:standard:c1 15
```

Query Syntax SENSe:CORRection:COLLect:CKIT:STANdard:C1?

Return Type Numeric

Default Not Applicable

SENSe:CORRection:COLLect:CKIT:STANdard:C2 <num>

Applicable Models: E5080A, M9485A

(Read-Write) Sets the C2 value (the third capacitance value) for the selected standard. For a detailed discussion of this value, search for App Note 8510-5B at www.Keysight.com.

Parameters

<num> Value for C2.

Examples

The following two commands set C2:

```
SENS:CORR:COLL:CKIT:STAN:C2 15
sense:correction:collect:ckit:standard:c2 15
```

Query Syntax SENSe:CORRection:COLLect:CKIT:STANdard:C2?

Return Type Numeric

Default Not Applicable

SENSe:CORRection:COLLect:CKIT:STANdard:C3 <num>

Applicable Models: E5080A, M9485A

(Read-Write) Sets the C3 value (the fourth capacitance value) for the selected standard. For a detailed discussion of this value, search for App Note 8510-5B at www.Keysight.com.

Parameters

<num> Value for C3.

Examples

The following two commands set C3

```
SENS:CORR:COLL:CKIT:STAN:C3 15
sense:correction:collect:ckit:standard:c3 15
```

Query Syntax

SENSe:CORRection:COLLect:CKIT:STANdard:C3?

Return Type

Numeric

Default

Not Applicable

SENSe:CORRection:COLLect:CKIT:STANdard:CHARacter <char>

Applicable Models: E5080A, M9485A

(Read-Write) Sets the media type of the selected calibration standard.

Parameters

<char> Media type of the standard. Choose from:
Coax - Coaxial Cable
Wave - Waveguide

Examples

```
SENS:CORR:COLL:CKIT:STAN:CHAR COAX
sense:correction:collect:ckit:standard:character wave
```

Query Syntax

SENSe:CORRection:COLLect:CKIT:STANdard:CHARacter?

Return Type

Numeric

Default

Coax

SENSe:CORRection:COLLect:CKIT:STANdard:DELay <num>

Applicable Models: E5080A, M9485A

(Read-Write) Sets the electrical delay value for the selected standard.

Parameters

<num> Electrical delay in picoseconds

Examples

The following two commands set delay to 50 picoseconds

```
SENS:CORR:COLL:CKIT:STAN:DEL 50e-12
sense2:correction:collect:ckit:standard:delay 50ps
```

Query Syntax

SENSe:CORRection:COLLect:CKIT:STANdard:DELay?

Return Type

Numeric

Default Not Applicable

SENSe:CORRection:COLLect:CKIT:STANdard:FMAXimum <num>

Applicable Models: E5080A, M9485A

(Read-Write) Sets the maximum frequency for the selected standard.

Parameters

<num> Maximum frequency in Hertz.

Examples

```
SENS:CORR:COLL:CKIT:STAN:FMAX 9e9
sense:correction:collect:ckit:standard:fmaximum 9Ghz
```

Query Syntax SENSe:CORRection:COLLect:CKIT:STANdard:FMAXimum?

Return Type Numeric

Default Not Applicable

SENSe:CORRection:COLLect:CKIT:STANdard:FMINimum <num>

Applicable Models: E5080A, M9485A

(Read-Write) Sets the minimum frequency for the selected standard.

Parameters

<num> Minimum frequency in Hertz.

Examples

```
SENS:CORR:COLL:CKIT:STAN:FMIN 1e3
sense:correction:collect:ckit:standard:fminimum 1khz
```

Query Syntax SENSe:CORRection:COLLect:CKIT:STANdard:FMINimum?

Return Type Numeric

Default Not Applicable

SENSe:CORRection:COLLect:CKIT:STANdard:IMPedance <num>

Applicable Models: E5080A, M9485A

(Read-Write) Sets the characteristic impedance for the selected standard.

Parameters

<num> Impedance in Ohms

Examples

```
SENS:CORR:COLL:CKIT:STAN:IMP 75
sense:correction:collect:ckit:standard:impedance 50.3
```

Query Syntax SENSE:CORRection:COLLect:CKIT:STANdard:IMPedance?

Return Type Numeric

Default 50

SENSe:CORRection:COLLect:CKIT:STANdard:L0 <num>

Applicable Models: E5080A, M9485A

(Read-Write) Sets the L0 value (the first inductance value) for the selected standard. For a detailed discussion of this value, search for App Note 8510-5B at www.Keysight.com.

Parameters

<num> Value for L0 in femtohenries (1E-15)

Examples

The following two commands set L0=15 femtohenries:

```
SENS:CORR:COLL:CKIT:STAN:L0 15
sense:correction:collect:ckit:standard:l0 15
```

Query Syntax SENSE:CORRection:COLLect:CKIT:STANdard:L0?

Return Type Numeric

Default Not Applicable

SENSe:CORRection:COLLect:CKIT:STANdard:L1 <num>

Applicable Models: E5080A, M9485A

(Read-Write) Sets the L1 value (the second inductance value) for the selected standard. For a detailed discussion of this value, search for App Note 8510-5B at www.Keysight.com.

Parameters

<num> Value for L1.

Examples

The following two commands set L1=15:

```
SENS:CORR:COLL:CKIT:STAN:L1 15
sense:correction:collect:ckit:standard:l1 15
```

Query Syntax SENSE:CORRection:COLLect:CKIT:STANdard:L1?

Return Type Numeric

Default Not Applicable

SENSe:CORRection:COLLect:CKIT:STANdard:L2 <num>

Applicable Models: E5080A, M9485A

(Read-Write) Sets the L2 value (the third inductance value) for the selected standard. For a detailed discussion of this value, search for App Note 8510-5B at www.Keysight.com.

Parameters

<num> Value for L2.

Examples

The following two commands set L2=15:

```
SENS:CORR:COLL:CKIT:STAN:L2 15
sense:correction:collect:ckit:standard:l2 15
```

Query Syntax

SENSe:CORRection:COLLect:CKIT:STANdard:L2?

Return Type

Numeric

Default

Not Applicable

SENSe:CORRection:COLLect:CKIT:STANdard:L3 <num>

Applicable Models: E5080A, M9485A

(Read-Write) Sets the L3 value (the fourth inductance value) for the selected standard. For a detailed discussion of this value, search for App Note 8510-5B at www.Keysight.com.

Parameters

<num> Value for L3.

Examples

The following two commands set L3=15:

```
SENS:CORR:COLL:CKIT:STAN:L3 15
sense:correction:collect:ckit:standard:l3 15
```

Query Syntax

SENSe:CORRection:COLLect:CKIT:STANdard:L3?

Return Type

Numeric

Default

Not Applicable

SENSe:CORRection:COLLect:CKIT:STANdard:LABel <name>

Applicable Models: E5080A, M9485A

(Read-Write) Sets the label for the selected standard. The label is used to prompt the user to connect the specified standard.

Parameters

<name> Label for the standard; Must be enclosed in quotes. Any string between **1** and **12** characters long. Cannot begin with a numeric.

Examples

```
SENS:CORR:COLL:CKIT:STAN:LAB 'OPEN'
sense:correction:collect:ckit:standard:label 'Short2'
```

Query Syntax	SENSe:CORRection:COLLect:CKIT:STANdard:LABel?
Return Type	String
Default	Not Applicable

SENSe:CORRection:COLLect:CKIT:STANdard:LOSS <num>

Applicable Models: E5080A, M9485A

(Read-Write) Sets the insertion loss for the selected standard.

Parameters

<num> Insertion loss in Gohms / sec. (GigaOhms per second of electrical delay)

Examples `SENS:CORR:COLL:CKIT:STAN:LOSS 3.5e9`
`sense:correction:collect:ckit:standard:loss 3`

Query Syntax	SENSe:CORRection:COLLect:CKIT:STANdard:LOSS?
Return Type	Numeric
Default	Not Applicable

SENSe:CORRection:COLLect:CKIT:STANdard:REMOve

Applicable Models: E5080A, M9485A

(Write only) Deletes the selected standard from the selected cal kit.

Examples `SENS:CORR:COLL:CKIT:STAN:REMOve`

Default Not Applicable

SENSe:CORRection:COLLect:CKIT:STANdard:SDEscription <string>

Applicable Models: E5080A, M9485A

(Read-Write) Modifies the description of the selected standard of the selected kit. This description appears in the [edit kit dialog box](#).

Parameters

<string> Description of the standard.

Examples `SENS:CORR:COLL:CKIT:STAN:SDES "My New Standard"`

Query Syntax	SENSe:CORRection:COLLect:CKIT:STANdard:SDEscription?
Return Type	String
Default	Not Applicable

SENSe:CORRection:COLLect:CKIT:STANdard[:SELEct] <num>

Applicable Models: E5080A, M9485A

(Read-Write) Selects the calibration standard. All subsequent "CKIT" commands to modify a standard will apply to the selected standard. Select a calibration kit using [SENS:CORR:COLL:CKIT:SEL](#)

Parameters

<num> Number of the standard. Choose any number between:
1 and 30

Examples

```
SENS:CORR:COLL:CKIT:STAN 3
sense:correction:collect:ckit:standard:select 8
```

Query Syntax SENSe:CORRection:COLLect:CKIT:STANdard[:SELEct]?

Return Type Numeric

Default 1

SENSe:CORRection:COLLect:CKIT:STANdard:TYPE <char>

Applicable Models: E5080A, M9485A

(Read-Write) Sets the type for the selected standard.

Parameters

<char> Choose from:
OPEN
SHORT
LOAD
SLOAD (sliding load)
THRU (through)
ARBI(arbitrary)

Examples

```
SENS:CORR:COLL:CKIT:STAN:TYPE LOAD
sense:correction:collect:ckit:standard:type short
```

Query Syntax SENSe:CORRection:COLLect:CKIT:STANdard:TYPE?

Return Type Character

Default Not Applicable

SENSe:CORRection:COLLect:CKIT:STANdard:TZReal <num>

Applicable Models: E5080A, M9485A

(Read-Write) Sets the TZReal component value of the Terminal Impedance for the selected standard.

Note: Only applicable when the Standard Type is set to **ARBI**

Parameters

<num> Value for TZReal in Ohms

Examples

The following commands set TZReal=15 Ohms:

```
SENS:CORR:COLL:CKIT:STAN:TZReal 15
sense:correction:collect:ckit:standard:TZReal 15
```

Query Syntax

SENSe:CORRection:COLLect:CKIT:STANdard:TZReal?

Return Type

Numeric

Default

Not Applicable

SENSe:CORRection:COLLect:CKIT:STANdard:TZImag <num>

Applicable Models: E5080A, M9485A

(Read-Write) Sets the TZImag component value of the Terminal Impedance for the selected standard.

Note: Only applicable when the Standard Type is set to **ARBI**

Parameters

<num> Value for TZImag in Ohms

Examples

The following two commands set TZImag=15 Ohms:

```
SENS:CORR:COLL:CKIT:STAN:TZImag 15
sense:correction:collect:ckit:standard:TZImag 15
```

Query Syntax

SENSe:CORRection:COLLect:CKIT:STANdard:TZImag?

Return Type

Numeric

Default

Not Applicable

SENSe:CORRection:COLLect:CKIT:TRLOption:IMPedance <char>

Applicable Models: E5080A, M9485A

(Read-Write) Sets the reference impedance when using this TRL cal kit. [Learn more](#).

Before sending this command, select a cal kit using [SENS:CORR:COLL:CKIT:SElect](#).

Parameters

<char> Choose from:

SYSTEM - The system impedance is used as the reference impedance. During a Guided or Unguided Cal, the Z0 of the Cal standard's connector definition sets the System Z0.

Make this selection when the desired test port impedance differs from the impedance of the LINE standard. Also, make this selection when skin effect impedance correction is desired for coax lines.

LINE The impedance of the line standard is used as the reference impedance, or center of the Smith Chart. Any reflection from the line standard is assumed to be part of the directivity error.

Examples `SENS:CORR:COLL:CKIT:TRL:IMP SYST`
`sense:correction:collect:ckit:trloption:impedance line`

Query Syntax `SENSe:CORRection:COLLect:CKIT:TRLoption:IMPedance?`

Return Type Character

Default LINE

`SENSe:CORRection:COLLect:CKIT:TRLoption:RPLane <char>`

Applicable Models: E5080A, M9485A

(Read-Write) Sets the reference impedance when using this cal kit. [Learn more](#).

Before sending this command, select a cal kit using [SENS:CORR:COLL:CKIT:SElect](#).

Parameters

<char> Choose from:

THRU The THRU standard definition is used to establish the measurement reference plane. Select if the THRU standard is zero-length or very short.

REFlect The REFLECT standard definition is used to establish the position of the measurement reference plane. Select if the THRU standard is not appropriate AND the delay of the REFLECT standard is well defined. Also, select If a flush short is used for the REFLECT standard because a flush short provides a more accurate phase reference than a Thru standard.

Examples `SENS:CORR:COLL:CKIT:TRL:RPL THRU`
`sense:correction:collect:ckit:trloption:rplane reflect`

Query Syntax `SENSe:CORRection:COLLect:CKIT:TRLoption:RPLane?`

Return Type Character

Default THRU

Last Modified:

16-Mar-2015 First Release



Sense:Correction:Cset Commands

Performs actions on calibration sets.

SENSe:CORRection:CSET

[ACTivate](#)

[COPY](#)

[CREate](#)

[DEACTivate](#)

[DESCRiption](#)

ETERm

| [CATalog?](#)

| [\[DATA\]](#)

[FLATten](#)

[NAME](#)

[SAVE](#)

[STANdard](#)

[STIMulus?](#)

TSET

| [ALLPorts?](#)

| [TYPE?](#)

TYPE

| [CATalog?](#)

Click on a [Red](#) keyword to view the command details.

See Also

- [Creating Cal Sets](#)
- [Example Programs](#)
- [Learn about Cal Sets](#)
- [Synchronizing the VNA and Controller](#)

SENSe<cnum>:CORRection:CSET:ACTivate <string>, <bool>

Applicable Models: E5080A, M9485A

([Read-Write](#)) Selects and applies a Cal Set to the specified channel.

Use [SENS:CORR:CSET:CAT?](#) to list the Cal Sets.

Parameters

- <cnun> Any existing channel number. If unspecified, value is set to 1
- <string> Cal Set to make active. Specify the Cal Set by **GUID** or **Name**. Use [SENS:CORR:CSET:CAT?](#) to list the available Cal Sets in either format.
- <bool> Should the Cal Set stimulus values be applied to the channel. Choose from:
ON (1) Apply the Cal Set stimulus values to the channel.
OFF (0) Do NOT apply the Cal Set stimulus values. If the Cal Set stimulus values do not match the channel stimulus values, then the following will occur:
- If interpolation is ON, then interpolation will be attempted. This may fail if the channel frequency is outside the range of the Cal Set.
 - If interpolation is OFF, the selection will be abandoned and an error is returned:

Examples

```
SENS:CORR:CSET:ACT "My2Port",1
sense:correction:cset:activate? name
'returns
"My2Port "
```

Query Syntax SENSE<cnun>:CORRection:CSET:ACTivate? [GUID|NAME]
Returns the name of the Cal Set that is applied to the specified channel. Choose from **GUID** or **NAME** to specify which string is returned. If unspecified, the GUID of the Cal Set is returned. If no Cal Set is applied to the specified channel, then "No Calset Selected" is returned.

Return Type String

Default Not Applicable

SENSe<cnun>:CORRection:CSET:COpy <string>

Applicable Models: E5080A, M9485A

(Write-only) Creates a new Cal Set and copies the current Cal Set data into it. Use this command to manipulate data on a Cal Set without corrupting the original cal data.

Parameters

- <cnun> Channel number using the Cal Set to be copied. If unspecified, value is set to 1
- <string> Name of the new Cal Set.

Examples

```
SENS2:CORR:CSET:COpy 'My2Port '
```

Query Syntax Not Applicable

Default Not Applicable

SENSe<cnun>:CORRection:CSET:CREate [name]

Applicable Models: E5080A, M9485A

(Write-only) Creates an empty Cal Set and attaches it to the specified channel. This command is ONLY necessary before remotely filling the Cal Set with error term data. (For Advanced Users).

A Cal Set is automatically created, applied to the channel, and saved at the completion of a guided cal according to the preference setting [SENS:CORR:PREF:CSET:SAVE](#).

Parameters

- <cnum> Any existing channel number. If unspecified, value is set to 1
- [name] Optional argument. Name of the Cal Set. Spaces or punctuation are NOT allowed. If unspecified, a unique name is chosen in the form "Calset_N" where N is a unique number.

Examples `SENS:CORR:CSET:CRE 'My2Port'`

Query Syntax Not Applicable

Default Not Applicable

SENSe:CORRection:CSET:DEACtivate

Applicable Models: E5080A, M9485A

This command is replaced by [CSET:DEAC](#).

(Write-only) Clears the calibration error when the frequency offset feature is set to OFF for the selected channel.

Parameters

- <string> Clears calibration error.

Examples `SENS:CORR:CSET:DEAC '{2B893E7A-971A-11d5-8D6C-00108334AE96}'`
`sense2:correction:cset:deactivate 'MyCalSet'`

Query Syntax Not Applicable

Default Not Applicable

SENSe<cnum>:CORRection:CSET:DESCription <string>

Applicable Models: E5080A, M9485A

(Read-Write) Sets or returns the descriptive string assigned to the selected Cal Set. Change this string so that you can easily identify each Cal Set. Apply and select the Cal Set using [SENS:CORR:CSET:ACT](#).

Parameters

- <cnum> Any existing channel number. If unspecified, value is set to 1

<string> The descriptive string associated with the currently-selected Cal Set

Examples `SENS:CORR:CSET:DESC 'MyCalSet'`
`sense2:correction:cset:description 'thisCalSet'`

Query Syntax SENSE<cnum>:CORRection:CSET:DESCription?

Return Type String

Default Not Applicable

SENSE<cnum>:CORRection:CSET:ETERm[:DATA] <string>,<r, i [r,i]...>

Applicable Models: E5080A, M9485A

(Read-Write) Sets or returns error term data for all VNA measurements.

Parameters

<cnum> Any existing channel number. If unspecified, value is set to 1

<string> (String) Error term to read or write. The error term is specified using the EXACT case-sensitive string displayed in the [Cal Set Viewer](#) utility. See [SENS:CORR:CSET:ETER:CAT?](#) for string.

<r,i> (Block) Error term data. A Real / Imaginary data pair for each data point. Format is set using [FORM:DATA](#) command. For REAL binary formats, refer to [Getting Data from the Analyzer using SCPI](#)

Examples `SENS:CORR:CSET:ETERM "Directivity(1,1)", 0.237,-1.422, 0.513, 0.895 ' set directivity(source error term for 2 points`
`SENS:CORR:CSET:ETERM? "Directivity(1,1)" 'read`

Query Syntax SENSE<cnum>:CORRection:CSET:ETERm[:DATA]? <string>

Return Type Block data

Default Not Applicable

SENSE<cnum>:CORRection:CSET:ETERm:CATalog?

Applicable Models: E5080A, M9485A

(Read-only) Returns a list of error term names found in the current Cal Set that is applied to the specified channel.

Parameters

Examples `SENS:CORR:CSET:ETER:CAT?`

```
'For a 1-port cal, returns
"Directivity(1,1),ReflectionTracking(1,1),SourceMatch(1,1)"
```

Return Type String

Default Not Applicable

SENSe<cnum>:CORRection:CSET:FLATten <string>

Applicable Models: E5080A, M9485A

(Write-only) When a Cal Set that was produced by a calibration has been interpolated or otherwise modified (for example, by [Fixturing operations](#)) this command saves the modified Cal Set to the VNA hard drive so that it can be reused. There is no User Interface equivalent for this command.

Background

When a Cal Set is selected for use by a channel, the channel reads the Cal Set from disk (master Cal Set). If the channel aligns perfectly with the Cal Set, the master Cal Set is used directly. In this case, the active Cal Set is the master Cal Set.

When processing occurs on the error terms due to interpolation or modification due to the use of fixturing, the channel will generate a temporary "memory-resident" Cal Set. In this case, the active Cal Set is the memory-resident Cal Set. This FLATten command allows you to save the active Cal Set to disk.

Depending on the measurement conditions, this flattening of the Cal Set can improve performance, especially if the Cal Set is applied often (using multiple recall states) or used by many channels.

Flattening a version of the Cal Set for each channel can avoid the interpolation or the fixturing processing that would otherwise occur when the Cal Set is selected or the instrument state is recalled.

You will have to manage the application of such a Cal Set as the VNA itself will have no way to determine what processing had been done once the flatten command is used. For example, if fixture de-embedding occurred prior to the flatten command, that Cal Set should then be applied WITHOUT fixturing on, because fixturing is already embedded in that Cal Set. It is your responsibility to apply the Cal Set properly.

If you want to repeatedly de-embed multiple networks (i.e. concatenate multiple 2-port de-embedding files) you can use the flatten command to create a new master Cal Set after each de-embed, and sequentially add additional de-embed networks.

Parameters

<cnum> Channel number on which the modified Cal Set resides. If unspecified, value is set to 1

<string> Name of the new Cal Set. Spaces or punctuation NOT allowed.

Examples `SENS:CORR:CSET:FLAT "MyCalSet"`

Query Syntax Not Applicable

Default Not Applicable

SENSe<cnum>:CORRection:CSET:NAME <string>

Applicable Models: E5080A, M9485A

(Read-Write) Sets or queries the name of the Cal Set currently applied to the specified channel.

Parameters

<cnum> Any existing channel number. If unspecified, value is set to 1

<string> Name of the Cal Set. Spaces or punctuation NOT allowed.

Examples

```
SENS:CORR:CSET:NAME 'MyCalSet'
sense2:correction:cset:name 'thisCalSet'
```

Query Syntax SENSE<cnum>:CORRection:CSET:NAME?

Return Type String

Default Not Applicable

SENSE<cnum>:CORRection:CSET:SAVE [<char>]

Applicable Models: E5080A, M9485A

(Read Write)

Saves the channel's Cal Set to the VNA hard drive. For example, use this command after writing data to a Cal Set using [SENS:CORR:CSET:DATA](#) (For Advanced Users).

The file name is saved as "**CSETx.cst**" where x is the user number assigned to <char>, and .cst specifies a Cal Set and instrument state. This is not the same syntax as a file saved through the default choices from the front panel, which is "**at00x.cst**". For more information on the file naming syntax, see the [MMEMory](#) subsystem. Learn more about [Instrument/Cal States](#).

Parameters

<cnum> Any existing channel number. If unspecified, value is set to 1

[<char>] Optional argument. Choose from:

USER01

USER02...

and so forth, until...

USER10

If <char> is NOT specified, changes that may have been made are saved to the cal set and NOT to the *.cst file.

Examples

```
SENS:CORR:CSET:SAVE USER03
sense2:correction:cset:save user09
'save changes to only the cal set'
SENS:CORR:CSET:SAVE
```

Query Syntax SENSE<cnum>:CORRection:CSET:SAVE?

Queries the last correction set saved.

Return Type Character

Default Not applicable

SENSe<cnum>:CORRection:CSET:STANdard <string>,<data>

Applicable Models: E5080A, M9485A

(Read-Write) Sets or returns standard data. Standard data is available for Unguided Cals ONLY.

Parameters

- <cnum> Any existing channel number. If unspecified, value is set to 1
- <string> (String) Cal standard to read or write. The standard is specified using the EXACT case-sensitive string displayed in the [Cal Set Viewer](#) utility. See [SENS:CORR:CSET:DATA](#) for a description of port numbers.
- <data> (Block). Acquisition data. A Real / Imaginary data pair for each data point. Format is set using [FORM:DATA](#) command. For REAL binary formats, refer to [Getting Data from the Analyzer using SCPI](#)

Examples

```
SENS:CORR:CSET:STAN 'S11C(1,1), 0.237,-1.422, 0.513, 0.895
' Set acquisition data for two points.
SENS:CORR:CSET:STAN? "S11C(1,1)" 'Read data
```

Query Syntax SENSe<cnum>:CORRection:CSET:STANdard? (string)

Return Type Block data

Default Not Applicable

SENSe<ch>:CORRection:CSET:STIMulus? [num]

Applicable Models: E5080A, M9485A

(Read-only) Returns the source or response stimulus values for the Cal Set that is currently used by channel <ch>. Values are returned in the format specified by [FORM:DATA](#) (Block or ASCII).

Parameters

- <ch> Channel number to query Cal Set stimulus values. If unspecified, value is set to 1
- [num] Optional argument. Range of frequencies to return. These values would be different when FOM (Opt 080) is enabled.
- 0 - returns source frequencies. Default setting if not specified.
 - 1 - returns response frequencies.
 - 2 - returns primary frequencies.

Examples `SENS:CORR:CSET:STIM?`
`sense:correction:cset:stimulus 1`

Return Type Numeric

Default Not Applicable

SENSe:CORRection:CSET:TSET:ALLPorts? <cset>

Applicable Models: E5080A, M9485A

(Read-only) Reads the port mapping used for the specified Cal Set. The returned values are the physical ports. The POSITION of the returned values corresponds to the logical ports.

For example, with an N44xx test set, if the returned string is "VNA 1,TS 2,VNA 2, TS 4" this means:

- VNA 1 is assigned to logical port 1
- TS 2 is assigned to logical port 2
- VNA 2 is assigned to logical port 3
- TS 4 is assigned to logical port 4

Parameters

<cset> **(String)** Name or GUID of the Cal Set. Use [SENS:CORR:CSET:CAT?](#) to read the list of available Cal Set names or GUIDs.

Examples `SENS:CORR:CSET:TSET:ALLP? "MyCalSet"`
`sense:correction:cset:tset:allports? "{2B893E7A-971A-11d5-8D6C-00108334AE96}"`

Return Type String

Default Not Applicable

SENSe:CORRection:CSET:TSET:TYPE? <cset>

Applicable Models: E5080A, M9485A

(Read-only) Reads the test set type (model) used for the specified Cal Set.

Parameters

<cset> **(String)** Name or GUID of the Cal Set. Use [SENS:CORR:CSET:CAT?](#) to read the list of available Cal Set names or GUIDs.

Examples `SENS:CORR:CSET:TSET:TYPE? "MyCalSet"`
'returns "N44xx"
`sense:correction:cset:tset:type? "{2B893E7A-971A-11d5-8D6C-00108334AE96}"`

E5080A

Return Type String

Default Not Applicable

SENSe<ch>:CORRection:CSET:TYPE:CATalog? [format]

Applicable Models: E5080A, M9485A

(Read-only) Query the Cal Types available in the selected Cal Set. The output is a comma separated list of Guids or a Cal Type names. Learn more about applying Cal Types using SCPI.

Use [CALC:CORR:TYPE](#) to apply a Cal Type.

Parameters

<ch> Any existing channel number. If unspecified, value is set to 1

[format] (Optional) Format of the output of cal types. choose from:

NAME - (default) returns a list of cal type string names.

GUID - returns a list of cal type GUIDs

Examples

```
SENS:CORR:CSET:TYPE:CAT? NAME
```

```
SENS2:CORRection:CSET:TYPE:CAT?
```

Return Type String

Default Not Applicable

Last modified:

16-Mar-2015 Initial Release



Sense:Correction:Extension Commands

Performs and applies Port Extensions.

SENSe:CORRection:EXTension:**AUTO**

| **CONFig**
| **DCOffset**
| **LOSS**
| **MEAS**
| **PORT**
| **RESet**
| **STARt**
| **STOP**

PORT

| **DISTance**
| **FREQ**
| **INCLude**
| [**STATe**]
| **LDC**
| **LOSS**
| **MEDium**
| **SYSMedia**
| **SYSVelocity**
| [**TIME**]
| **UNIT**
| **VELFactor**
| **WGCutoff**

[**STATe**]

Click on a **Red** keyword to view the command details.

See Also

- Example Programs
- [Learn about Port Extensions](#)
- [Synchronizing the VNA and Controller](#)
- [SCPI Command Tree](#)

SENSe<num>:CORRection:EXTension:AUTO:CONFig <char>

Applicable Models: E5080A, M9485A

(Read-Write) Sets the frequencies used to calculate Automatic Port Extension. [Learn more about calculating Automatic Port Extension.](#)

Parameters

- <num> Any existing channel number. If unspecified, value is set to 1
- <char> Frequencies to be used:
- CSPN** Use current frequency span.
 - AMKR** - Use active marker frequency.
 - USPN** - Use custom user span. Use [SENS:CORR:EXT:AUTO:STAR](#) and [SENS:CORR:EXT:AUTO:STOP](#) to specify start and stop frequency.

Examples

```
SENS:CORR:EXT:AUTO:CONF CSPN
sense2:correction:extension:auto:config amkr
```

Query Syntax SENSE<num>:CORRection:EXTension:AUTO:CONFig ?

Return Type Character

Default CSPN

SENSE<num>:CORRection:EXTension:AUTO:DCOffset <bool>

Applicable Models: E5080A, M9485A

(Read-Write) Specifies whether or not to include DC Offset as part of automatic port extension. [Learn more about Automatic DC Offset.](#) Only allowed when [SENS:CORR:EXT:AUTO:LOSS](#) is set to ON.

Parameters

- <num> Any existing channel number. If unspecified, value is set to 1
- <bool> ON (or 1) - Includes DC Offset correction.
OFF (or 0) - Does NOT include DC Offset correction.

Examples

```
SENS:CORR:EXT:AUTO:DCOF 1
sense2:correction:extension:auto:dcoffset off
```

Query Syntax SENSE<num>:CORRection:EXTension:AUTO:DCOffset?

Return Type Boolean

Default ON (1)

SENSE<num>:CORRection:EXTension:AUTO:LOSS <bool>

Applicable Models: E5080A, M9485A

(Read-Write) Specifies whether or not to include loss correction as part of automatic port extension. [Learn more about Loss Compensation](#) in port extension.

Parameters

- <cnum> Any existing channel number. If unspecified, value is set to 1
- <bool> ON (or 1) - Includes Loss correction.
OFF (or 0) - Does NOT include Loss correction.

Examples

```
SENS:CORR:EXT:AUTO:LOSS 1
sense2:correction:extension:auto:loss off
```

Query Syntax SENSE<cnum>:CORRection:EXTension:AUTO:LOSS?

Return Type Boolean

Default ON (1)

SENSe<cnum>:CORRection:EXTension:AUTO:MEASure <char>

Applicable Models: E5080A, M9485A

(Write-only) Measures either an OPEN or SHORT standard. When this command is sent, the VNA acquires the measurement with which to set automatic port extensions. [Learn more about which standard to measure.](#)

Parameters

- <cnum> Any existing channel number. If unspecified, value is set to 1
- <char> Standard to be measured. Choose from:
OPEN Measure OPEN standard
SHORT Measure SHORT standard

Examples

```
SENS:CORR:EXT:AUTO:MEAS OPEN
sense2:correction:extension:auto:measure short
```

Query Syntax Not Applicable

Default Not Applicable

SENSe<cnum>:CORRection:EXTension:AUTO:PORT<n> <bool>

Applicable Models: E5080A, M9485A

(Read-Write) Enables and disables automatic port extensions on the specified port.

Parameters

- <cnum> Any existing channel number. If unspecified, value is set to 1
- <n> VNA Port number to enable or disable for automatic port extensions.
- <bool> ON (or 1) - Enable
OFF (or 0) - Disable

Examples `SENS:CORR:EXT:AUTO:PORT2 0`
`sense2:correction:extension:auto:port4 on`

Query Syntax `SENSe<cnum>:CORRection:EXTension:AUTO:PORT<n>?`

Return Type Boolean

Default All ports ON (enabled)

`SENSe<cnum>:CORRection:EXTension:AUTO:RESet`

Applicable Models: E5080A, M9485A

(Write-only) Clears old port extension delay and loss data in preparation for acquiring new data. Send this command prior to sending a new series of [SENS:CORR:EXT:AUTO:MEAS](#). If acquiring both OPEN and SHORT standards, do not send this command between those acquisitions.

Parameters

- <cnum> Any existing channel number. If unspecified, value is set to 1

Examples `SENS:CORR:EXT:AUTO:RES`
`sense2:correction:extension:auto:reset`

Query Syntax Not Applicable

Default Not Applicable

`SENSe<cnum>:CORRection:EXTension:AUTO:STARt <value>`

Applicable Models: E5080A, M9485A

(Read-Write) Set the start frequency for custom user span. [Learn more about User Span.](#)

Parameters

- <cnum> Any existing channel number. If unspecified, value is set to 1
- <value> User span start value. Must be within the frequency range of the active channel and less than the value set by `SENS:CORR:EXT:AUTO:STOP`.

Examples `SENS:CORR:EXT:AUTO:STAR 1E9`
`sense2:correction:extension:auto:start 200e6`

Query Syntax SENSE<cnm>:CORRection:EXTension:AUTO:STARt <value>?

Return Type Numeric

Default Start frequency of the current active channel.

SENSe<cnm>:CORRection:EXTension:AUTO:STOP <value>

Applicable Models: E5080A, M9485A

(Read-Write) Set the stop frequency for custom user span. [Learn more about User Span.](#)

Parameters

<cnm> Any existing channel number. If unspecified, value is set to 1

<value> User span stop value. Must be within the frequency range of the active channel and greater than the value set by SENS:CORR:EXT:AUTO:STARt

Examples

```
SENS:CORR:EXT:AUTO:STOP 1E9
sense2:correction:extension:auto:stop 200e6
```

Query Syntax SENSE<cnm>:CORRection:EXTension:AUTO:STOP <value>?

Return Type Numeric

Default Stop frequency of the current active channel.

SENSe<cnm>:CORRection:EXTension:PORT<pnum>:DISTance <value>

Applicable Models: E5080A, M9485A

(Read-Write) Sets and returns the port extension delay in physical length (distance).

Parameters

<cnm> Any existing channel number. If unspecified, value is set to 1.

<pnum> Port Number that will receive the delay setting. If unspecified, value is set to 1.

<value> Physical length of fixture of added transmission line. First specify units with [SENS:CORR:EXT:PORT:UNIT](#).

Examples

```
SENS:CORR:EXT:PORT1:DIST 12
sense2:correction:extension:port2:distance .003
```

Query Syntax SENSE<cnm>:CORRection:EXTension:PORT<pnum>:DISTance?

Return Type Numeric

Default 0

SENSe<cnum>:CORRection:EXTension:PORT<pnum>:FREQUency<n> <value>

Applicable Models: E5080A, M9485A

(Read-Write) Sets and returns the frequency for the Freq and Loss pair number and for the specified port number.

[Learn about Loss Compensation values.](#)

Parameters

- <cnum> Any existing channel number. If unspecified, value is set to 1
- <pnum> Port Number that will receive the freq/loss settings. If unspecified, value is set to 1.
- <n> Freq and Loss pair number. Choose from 1 or 2. If unspecified, value is set to 1.
- <value> Frequency value. Choose a frequency within the frequency span of the VNA.

Examples

```
SENS:CORR:EXT:PORT1:FREQ1 10E9
sense2:correction:extension:port2:freq2 2E10
```

Query Syntax SENSe<cnum>:CORRection:EXTension:PORT<pnum>:FREQUency<n>?

Return Type Numeric

Default 1 GHz

SENSe<cnum>:CORRection:EXTension:PORT<pnum>:INCLude<n>[:STATe] <bool>

Applicable Models: E5080A, M9485A

(Read-Write) Sets and returns the ON/OFF state for the Freq and Loss pair number and for the specified port number.

[Learn about Loss Compensation values.](#)

Note: This command affects ALL measurements on the specified channel.

Parameters

- <cnum> Any existing channel number. If unspecified, value is set to 1
- <pnum> Port Number that will receive the Freq/Loss settings. If unspecified, value is set to 1.
- <n> Freq and Loss pair. Choose from 1 or 2. If unspecified, value is set to 1.
- <value> State of Freq and Loss values for port extension.

0 or OFF Specified Freq and Loss values are OFF

1 or ON Specified Freq and Loss values are ON

Examples `SENS:CORR:EXT:PORT:INCL 0`
`sense2:correction:extension:port2:include2:state on`

Query Syntax `SENSe<cnum>:CORRection:EXTension:PORT<pnum>:INCLude[:STATe]?`

Return Type Boolean

Default OFF

`SENSe<cnum>:CORRection:EXTension:PORT<pnum>:LDC <value>`

Applicable Models: E5080A, M9485A

(Read-Write) Sets and returns the Port Loss at DC value for the specified port number.

[Learn about Loss Compensation values.](#)

Note: This command affects ALL measurements on the specified channel.

Parameters

<cnum> Any existing channel number. If unspecified, value is set to 1

<pnum> Port number to receive Loss value. If unspecified, value is set to 1.

<value> Loss in dB. Choose a value between -90 and 90

Examples `SENS:CORR:EXT:PORT:LDC 1.5`
`sense2:correction:extension:port2:ldc .1`

Query Syntax `SENSe<cnum>:CORRection:EXTension:PORT<pnum>:LDC?`

Return Type Numeric

Default 0

`SENSe<cnum>:CORRection:EXTension:PORT<pnum>:LOSS<n> <value>`

Applicable Models: E5080A, M9485A

(Read-Write) Sets and returns the Loss value for the specified port number.

[Learn about Loss Compensation values.](#)

Note: This command affects ALL measurements on the specified channel.

Parameters

<cnum> Any existing channel number. If unspecified, value is set to 1

<pnum> Port Number that will receive the Freq/Loss settings. If unspecified, value is set to 1.

<n> Loss "Use" number. Choose from 1 or 2. If unspecified, value is set to 1.

<value> Loss in dB. Choose a value between -90 and 90

Examples

```
SENS:CORR:EXT:PORT:LOSS1 1
sense2:correction:extension:port2:loss2 .1
```

Query Syntax SENSE<cnum>:CORRection:EXTension:PORT<pnum>:LOSS<n>?

Return Type Numeric

Default 0

SENSe<cnum>:CORRection:EXTension:PORT<pnum>:MEDium <char>

Applicable Models: E5080A, M9485A

(Read-Write) Sets and returns the media type of the added fixture or transmission line.

See also [SENS:CORR:EXT:PORT:SYSMedia](#)

Note: This command affects ALL measurements on the specified channel.

Parameters

<cnum> Any existing channel number. If unspecified, value is set to 1

<pnum> Port Number for which media type is being set. If unspecified, value is set to 1.

<char> Medium type. Choose from:

- COAX
- WAVEguide

Examples

```
SENS:CORR:EXT:PORT:MED COAX
sense2:correction:extension:port2:medium waveguide
```

Query Syntax SENSE<cnum>:CORRection:EXTension:PORT<pnum>:MEDium?

Return Type Character

Default COAX

SENSe<cnum>:CORRection:EXTension:PORT<pnum>:SYSMedia <bool>

Applicable Models: E5080A, M9485A

(Read-Write) Sets and returns the state of coupling with the system Media type. [Learn more.](#)

Note: This command potentially affects ALL measurements on the VNA.

Parameters

- <cnum> Any existing channel number. If unspecified, value is set to 1
- <pnum> Port Number for which system Velocity Factor coupling is being set. If unspecified, value is set to 1.
- <bool> Coupling state. Choose from:
- **ON** (or 1) - Media type is coupled with the system setting.
 - **OFF** (or 0) - Media type is NOT coupled with the system setting.

Examples

```
SENS:CORR:EXT:PORT:SYSM 1
sense2:correction:extension:port2:sysmedia off
```

Query Syntax SENSE<cnum>:CORRection:EXTension:PORT<pnum>:SYSMedia?

Return Type Boolean

Default 1 or ON (Coupled)

SENSE<cnum>:CORRection:EXTension:PORT<pnum>:SYSVelocity <bool>

Applicable Models: E5080A, M9485A

(Read-Write) Sets and returns the state of coupling with the system Velocity Factor value. [Learn more.](#)

Note: This command potentially affects ALL measurements on the VNA.

Parameters

- <cnum> Any existing channel number. If unspecified, value is set to 1
- <pnum> Port Number for which system Velocity Factor coupling is being set. If unspecified, value is set to 1.
- <bool> Coupling state. Choose from:
- **ON** (or 1) - Velocity Factor is coupled with the system setting.
 - **OFF** (or 0) - Velocity Factor is NOT coupled with the system setting.

Examples

```
SENS:CORR:EXT:PORT:SYSV 1
sense2:correction:extension:port2:sysvelocity off
```

Query Syntax SENSE<cnum>:CORRection:EXTension:PORT<pnum>:SYSVelocity?

Return Type Boolean

Default 1 or ON (Coupled)

SENSe<cnum>:CORRection:EXTension:PORT<pnum>[:TIME] <num>

Applicable Models: E5080A, M9485A

(Read-Write) Sets the extension delay value in time at the specified port. Must also set [SENS:CORR:EXT ON](#).

Note: This command affects ALL measurements on the specified channel.

Parameters

- <cnum> Any existing channel number. If unspecified, value is set to 1
- <pnum> Port Number that will receive the extension. If unspecified, value is set to 1.
- <num> The port extension in seconds; may include suffix. Choose a number between: -1E18 and 1E18

Examples

```
SENS:CORR:EXT:PORT 2MS
sense2:correction:extension:port2 .00025
```

Query Syntax SENSe<cnum>:CORRection:EXTension:PORT<pnum> [:TIME]?

Return Type Numeric

Default 0

SENSe<cnum>:CORRection:EXTension:PORT:UNIT <char>

Applicable Models: E5080A, M9485A

(Read-Write) Sets and returns the units for specifying port extension delay in physical length (distance).

Parameters

- <cnum> Any existing channel number. If unspecified, value is set to 1.
- <char> Units for delay in distance. Choose from:
- METer
 - FEET
 - INCH

Examples

```
SENS:CORR:EXT:PORT:UNIT MET
sense2:correction:extension:port:unit inch
```

Query Syntax SENSe<cnum>:CORRection:EXTension:PORT:UNIT?

Return Type Character

Default METer

SENSE<cnm>:CORRection:EXTension:PORT<pnm>:VELFactor <value>

Applicable Models: E5080A, M9485A

(Read-Write) Sets and returns the velocity factor of the fixture or added transmission line.

Parameters

<cnm> Any existing channel number. If unspecified, value is set to 1

<pnm> Port Number for which velocity factor is being set. If unspecified, value is set to 1.

<value> Velocity Factor.

Set [SENS:CORR:EXT:PORT:SYSV](#) to use the system velocity factor.

Examples

```
SENS:CORR:EXT:PORT:VELF .6
sense2:correction:extension:port2:velfactor 1
```

Query Syntax SENSE<cnm>:CORRection:EXTension:PORT<pnm>:VELFactor?

Return Type Numeric

Default System Velocity Factor

SENSE<cnm>:CORRection:EXTension:PORT<pnm>:WGCutoff <value>

Applicable Models: E5080A, M9485A

(Read-Write) Sets and returns the cutoff (minimum) frequency of the added waveguide fixture or transmission line.

Parameters

<cnm> Any existing channel number. If unspecified, value is set to 1

<pnm> Port Number for which media type is being set. If unspecified, value is set to 1.

<value> Cutoff frequency in Hz.

This value is ignored when [SENS:CORR:EXT:PORT:MED](#) is set to **COAX** for the same port.

Examples

```
SENS:CORR:EXT:PORT:WGC 1e8
sense2:correction:extension:port2:wgcutoff 100Mhz
```

Query Syntax SENSE<cnm>:CORRection:EXTension:PORT<pnm>:WGCutoff?

Return Type Numeric

Default System Media Cutoff Frequency

SENSe<cnum>:CORRection:EXTension[:STATe] <ON | OFF>

Applicable Models: E5080A, M9485A

(Read-Write) Turns port extensions ON or OFF.

Parameters

<cnum> Any existing channel number. If unspecified, value is set to 1

<ON | OFF> **ON** (or 1) - turns port extensions ON.

OFF (or 0) - turns port extensions is OFF.

Examples

```
SENS:CORR:EXT ON
sense2:correction:extension:state off
```

Query Syntax SENSe<cnum>:CORRection:EXTension[:STATe]?

Return Type Boolean (1 = ON, 0 = OFF)

Default OFF

Last Modified:

16-Mar-2015 First Release



Sense:Correction:Collect:Guided Commands

Performs and applies a SmartCal (Guided) calibration and other error correction features.

To perform a **Guided Calibration**, use ONLY [Sens:Corr:Coll:Guided](#) commands. See the "Guided" example programs for clarification.

SENSe:CORRection:COLLect:GUIDed:
ABORt
ACQuire
ADAPter

 | **COUNt**

 | **ZERO**

 | **CREate?**

 | **DELay**

 | **DESCription**

 | **PATHs**
CHANnel:MODE
CKIT

 | **CATalog?**

 | **PORT**

 | **[SElect]**
CONNector

 | **CATalog?**

 | **PORT**

 | **[SElect]**
DESCription
ETERms:LOAD

 | **[CSET]**
INITiate
ISOLation

 | **AVERage**

 | **INCRement**

 | **PATHs**
ITERations

 | **COUNt?**

 | **MINimum?**

 | **RESet**
PACQuire
PATH

 | **CMETHod**

 | **TMETHod**

PREFerence
 | **SLID**ingload
PSEnsor - **More** commands
SAVE
 | **CSE**T
SMC - **More** commands
STEPS?
THRU

Click on a [blue](#) keyword to view the command details.

See Also

ECal Orientation commands

Examples using these commands.

Calibrating the VNA Using SCPI

[Learn about Measurement Calibration](#)

[Synchronizing the VNA and Controller](#)

SENSe<ch>:CORRection:COLLect:GUIDed:ABORt

Applicable Models: E5080A, M9485A

(Write-only) Aborts the acquiring of a guided calibration that has been [INITialized](#) but has not yet been concluded using the [SAVE](#) command. If at least one Cal standard has already been measured, and the [Calibration Window](#) is being displayed, this command also closes the Calibration Window and re-tiles the other measurement windows.

Parameters

<ch> Channel being calibrated, depending on the [CHAN:MODE](#) setting. If unspecified, value is set to 1.

Examples

```
SENS:CORR:COLL:GUID:ABOR
sense2:correction:collect:guided:abort
```

Query Syntax Not Applicable

Default Not Applicable

SENSe:<ch>CORRection:COLLect:GUIDed[:ACQuire] <std>[,sync]

Applicable Models: E5080A, M9485A

(Write-only) Initiates the measurement of the specified calibration standard. Executing this command with an unnecessary standard has no affect.

The measured data is stored and used for subsequent calculations of error correction coefficients. All standards must be measured before a calibration can be completed. Any measurement can be repeated until the [SENS:CORR:COLL:GUID:SAVE](#) command is executed.

Query the user prompt description using [SENS:CORR:COLL:GUID:DESC?](#)

Query the required calibration steps using [SENS:CORR:COLL:GUID:STEP?](#)

Parameters

<ch> Channel being calibrated, depending on the [CHAN:MODE](#) setting. If unspecified, value is set to 1.

<std> Choose from: STAN1, STAN2, STAN3, through STAN40

[sync] Optional argument. Choose from:

SYNChronous - blocks SCPI commands during standard measurement (default behavior).

ASYNchronous - does NOT block SCPI commands during standard measurement.

[Learn more about this argument](#)

Examples

```
SENS:CORR:COLL:GUID STAN1
sense2:correction:collect:guided:acquire stan1
```

Query Syntax Not Applicable

Default Not Applicable

SENSE<ch>:CORREction:COLLECT:GUIDed:ADAPter:CREate? <conn1>, <conn2>

Applicable Models: E5080A, M9485A

(Read-only) Specifies the use of a THRU adapter to be used during the Guided Cal Unknown THRU and Adapter Removal Cal. Returns an adapter index <n> which is used to refer to the adapter in several related commands. [See Cal Thru Methods](#). While the choice of which end of the adapter is <conn1> and <conn2> is arbitrary, it is necessary to remember which will be used on each test port.

The settings for this command remain until Preset, or the command is sent using a different setting, or until the [ZERO](#) command is sent.

Parameters

<ch> Channel being calibrated, depending on the [CHAN:MODE](#) setting. If unspecified, value is set to 1.

<conn1> Adapter port 1 connector type. Use [SENS:CORR:COLL:GUID:CONN:CAT?](#) to return a list of valid connector types.

<conn2> Adapter port 2 connector type.

Examples

See example using this command.

Return Type Numeric

Default Not Applicable

SENSE<ch>:CORREction:COLLECT:GUIDed:ADAPter:COUNt?

Applicable Models: E5080A, M9485A

(Read-Only) Returns the number of THRU adapters that have been created for this calibration using [SENS:CORR:COLL:GUID:ADAP:CREate](#).

Parameters

<ch> Channel being calibrated, depending on the [CHAN:MODE](#) setting. If unspecified, value is set to 1.

Examples See example using this command.

Return Type Numeric

Default Not Applicable

SENSe:<ch>CORRection:COLLEct:GUIDed:ADAPter:COUNt:ZERO

Applicable Models: E5080A, M9485A

(Write-only) Removes all adapters that have been defined for calibrations on the specified channel using [SENS:CORR:COLL:GUID:ADAP:CREate](#).

Parameters

<ch> Channel being calibrated, depending on the [CHAN:MODE](#) setting. If unspecified, value is set to 1.

Examples `SENS:CORR:COLL:GUID:ADAP:COUNt:ZERO`
`sense2:correction:collect:guided:adapter:count:zero`

Query Syntax Not Applicable

Default Not Applicable

SENSe<ch>:CORRection:COLLEct:GUIDed:ADAPter<n>:DELay <coax>, [w phase, wdelay]

Applicable Models: E5080A, M9485A

(Write-only) Specifies the adapter delay and optionally waveguide delay and optional phase offset (degrees) of adapter <n>.

The settings for this command remain until Preset, or the command is sent using a different setting, or until the [ZERO](#) command is sent.

Parameters

<ch> Channel being calibrated, depending on the [CHAN:MODE](#) setting. If unspecified, value is set to 1.

<n> Adapter index number that was returned from [SENS:CORR:COLL:GUID:ADAP:CREate?](#)

- <coax> Delay value of coax adapter <n> in seconds. If the adapter has no coax connector, enter 0.
- <wphase> Waveguide phase offset in degrees. If the adapter has no waveguide connector, do not enter a value.
- <wdelay> Waveguide delay in seconds. If the adapter has no waveguide connector, do not enter a value.

Examples See example using this command.

Default Not Applicable

SENSE<ch>:CORRection:COLLect:GUIDed:ADAPter<n>:DESCription <string>

Applicable Models: E5080A, M9485A

(Write-only) Specifies the adapter description for use as the guided cal connection prompts.

The settings for this command remain until Preset, or the command is sent using a different setting, or until the [ZERO](#) command is sent.

Parameters

- <ch> Channel being calibrated, depending on the [CHAN:MODE](#) setting. If unspecified, value is set to 1.
- <n> Adapter index number that was returned from [SENS:CORR:COLL:GUID:ADAP:CREate?](#)
- <string> Adapter description.

Examples See example using this command.

Query Syntax Not Applicable

Default Not Applicable

SENSE<ch>:CORRection:COLLect:GUIDed:ADAPter<n>:PATHs <port pairs>

Applicable Models: E5080A, M9485A

(Write-only) Specifies the port pairs for which the adapter will be used for a THRU connection.

For example, for a 3-port cal on channel 1 using ports 1,2,and 3), to use adapter 1 between the ports (1 to 2) and (1 to 3) the following command is used: SENS1:CORR:COLL:GUID:ADAP1:PATH 1,2,1,3.

The adapter must have the same DUT connectors as the ports that are already specified for these ports.

The settings for this command remain until Preset, or the command is sent using a different setting, or until the [ZERO](#) command is sent.

Parameters

<ch> Channel being calibrated, depending on the [CHAN:MODE](#) setting. If unspecified, value is set to 1.

<n> Adapter index number that was returned from [SENS:CORR:COLL:GUID:ADAP:CREate?](#)

<port pair> Ports for which the adapter will be used. The orientation is not critical, as the VNA will align the connector types as necessary. The minimum number of Thru connections required is the number of ports to calibrated -1.

Examples See example using this command.

Query Syntax Not Applicable

Default Not Applicable

SENSe:CORRection:COLLect:GUIDed:CHANnel:MODE <bool>

Applicable Models: E5080A, M9485A

(Read-Write) Determines whether or not to honor the channel <ch> argument in guided calibration SCPI commands.

Parameters

<bool> **OFF (0)** Honor all <ch> arguments. This means the <ch> channel is calibrated regardless of which channel is currently active.

ON (1) Legacy behavior. Behavior is specified by the following table:

<ch> channel type Std or App	Active channel type Std or App	Behavior
Std	Std	Active chan cal'd
Std	App	"Channel not found" error
App	Std	<ch> chan cal'd
App	App	<ch> chan cal'd

Learn about [Standard vs Application](#) channels.

Examples `SENS:CORR:COLL:GUID:CHAN:MODE 0`
`sense:correction:collect:guided:channel:mode ON`

Query Syntax SENSe:CORRection:COLLect:GUIDed:CHANnel:MODE?

Return Type Boolean

Default OFF

SENSe:CORRection:COLLect:GUIDed:CKIT:CATalog? <connector>

Applicable Models: E5080A, M9485A

(Read-only) This command replaces [SENS:CORR:COLL:GUID:CKIT:PORT:CAT?](#)

Returns a comma-separated list of valid kits that use the specified connector type. This includes mechanical cal kits, applicable characterizations found within ECal modules currently connected to the VNA, **and all user characterizations stored in VNA disk memory**. For ECal modules, the returned list includes the serial numbers. See ECal User Characterization commands.

Use items in the list to select the kit to be used with the [SENS:CORR:COLL:GUID:CKIT:PORT](#) and SENSe<ch>:CORRection:COLLect:GUIDed:PSEnSor<pnum>:CKIT commands.

Parameters

<conn> String. Connector type. Use [SENS:CORR:COLL:GUID:CONN:CAT?](#) to return a list of valid connector types.

Examples `SENSe:CORR:COLL:GUID:CKIT:CAT? "Type N (50) male"`

Return Type String

Default Not Applicable

SENSe<ch>:CORRection:COLLect:GUIDed:CKIT:PORT<pnum>[:SElect] <kit>

Applicable Models: E5080A, M9485A

(Read-Write) Specifies the calibration kit (mechanical or ECal) for each port to be used during a guided calibration. An unused port does NOT need to have a specified Cal Kit.

1. Specify the connector type for the port with [SENS:CORR:COLL:GUID:CONN:PORT](#).
2. Query the valid available kits for the connector on each port with [SENS:CORR:COLL:GUID:CKIT:PORT:CAT?](#)
3. Specify the kit using this command.
4. Perform a query of this command. If the <kit> parameter was incorrectly entered, an error will be returned.

When using this command to specify the cal kit for the output of a VMC calibration mixer, specify port 3. If port 3 is already used for the output of the DUT mixer, then specify port 4. [Learn more](#).

Parameters

<ch> Channel being calibrated, depending on the [CHAN:MODE](#) setting. If unspecified, value is set to 1.

<pnum> Any existing port number. If unspecified, value is set to 1

<kit> Calibration kit to be used for the specified port. **Case-sensitive.**

When using an ECal module, include the characterization name in the <kit> string. Use [SENSe:CORR:COLL:GUID:CKIT:CAT?](#) to read the list of characterizations available in the module and in VNA disk memory.

If two or more identical ECal modules are connected to the VNA, the serial number must be included to distinguish the ECal modules.

Examples

```
'Note: All of the following examples specify port 1 only
' Mechanical Cal kit
SENS:CORR:COLL:GUID:CKIT:PORT1 '85055A'
' Standard ECal modules
SENS:CORR:COLL:GUID:CKIT:PORT1 "N4691-60004 ECal"
' Non-factory ECal characterizations are specified as
follows:
SENS:CORR:COLL:GUID:CKIT:PORT1 "N4691-60004 User 1 ECal"
' When two or more ECal modules with the same model number
are
' connected, also specify the serial number as follows:
SENS:CORR:COLL:GUID:CKIT:PORT1 "N4691-60004 ECal 01234"
' When Disk Memory ECal user characterizations are used,
' specify both the User char and the serial number as
follows:
SENS:CORR:COLL:GUID:CKIT:PORT1 "N4691-60004 MyDskChar ECal
01234"
```

Query Syntax SENSE:CORRection:COLLect:GUIDed:CKIT:PORT<pnum>[:SElect]?

Return Type String - If the <kit> parameter was incorrectly entered while writing, an error will be returned.

Default Not Applicable

SENSe:CORRection:COLLect:GUIDed:CONNector:CATalog?

Applicable Models: E5080A, M9485A

(Read only) Returns a list of valid connectors based on the connector descriptions of the available cal kits. Use an item from the returned list to specify a connector for [SENS:CORR:COLL:GUID:CONN:PORT](#)

Here are the more common connector types:

W-band waveguide	Type B	1.00 mm female
V-band waveguide	Type A (50) female	1.00 mm male
U-band waveguide	Type A (50) male	1.85 mm male
R-band waveguide	Type F (75) female	1.85 mm female
Q-band waveguide	Type F (75) male	2.92 mm female
K-band waveguide	Type N (75) female	2.92 mm male

P-band waveguide	Type N (75) male	APC 2.4 female
X-band waveguide	Type N (50) female	APC 2.4 male
7-16 female	Type N (50) male	APC 3.5 female
7-16 male		APC 3.5 male
		APC 7

Examples

```
SENS:CORR:COLL:GUID:CONN:CAT?
```

Returns:

```
Type N (50) female, Type N (50) male, APC 7 (50), 3.5 mm (50) male, 3.5 mm (50) female, User Connector A
```

Return Type Comma separated string values

Default Not Applicable

SENSe<ch>:CORRection:COLLect:GUIDed:CONNector:PORT<pnum>[:SElect] <conn>

Applicable Models: E5080A, M9485A

(Read-Write) Specifies a connector type for every port during the Guided Calibration procedure. Valid connector names are stored within calibration kits. Some cal kits may include both male and female connectors. Therefore, specifying connector gender may be required.

The VNA remembers previous Guided Cal settings. Therefore, for completeness, unused ports should be defined as "Not used". See Guided Cal examples.

- A single port with a valid <conn> name indicates a 1-Port calibration will be performed.
- Two ports with valid <conn> names indicate either a 2-Port SOLT or [TRL](#) calibration will be performed depending on the standards definition found within the cal kit and the capability of the VNA.
- Three ports with valid <conn> names indicate a 3-Port calibration will be performed, and so forth.

Follow these steps to ensure port connectors are specified correctly:

1. Use [SENS:CORR:COLL:GUID:CONN:CAT?](#) to query available connectors before specifying the port connector.
2. Set a connector type for each port using this command.
3. Perform a query of this command. If the connector type was incorrectly entered, an error will be returned.
4. Specify the cal kit to use for each port with [SENS:CORR:COLL:GUID:CKIT:PORT](#)

Parameters

<ch> Channel being calibrated, depending on the [CHAN:MODE](#) setting. If unspecified, value is set to 1.

<pnum> Any existing port number. If unspecified, value is set to 1.

<conn> String - DUT connector type to connect with VNA port <pnum>. **Case-sensitive.**

Examples `'Specifying a 2-port cal (1 & 2) on a 4-port VNA`

```
SENS:CORR:COLL:GUID:CONN:PORT1 'Type N (50) female'
SENS:CORR:COLL:GUID:CONN:PORT2 'Type N (50) male'
SENS:CORR:COLL:GUID:CONN:PORT3 'Not used'
SENS:CORR:COLL:GUID:CONN:PORT4 'Not used'
```

Query Syntax `SENSe:CORRection:COLLect:GUIDed:CONNector:PORT<pnum>[:SElect]?`

Return Type String

Default Not Applicable

`SENSe<ch>:CORRection:COLLect:GUIDed:DESCription? <step>`

Applicable Models: E5080A, M9485A

(Read-only) Returns the connection description for the specified calibration step.

Parameters

<ch> Channel being calibrated, depending on the [CHAN:MODE](#) setting. If unspecified, value is set to 1.

<step> A number from 1 to the number of steps required to complete the calibration (Use [SENS:CORR:COLL:GUID:STEP?](#) to query the number of steps)

Examples `SENS:CORR:COLL:GUID:DESC? 10`

```
'Returns:
Connect APC 7 Open to port3
```

Return Type String

Default Not Applicable

`SENSe<ch>:CORRection:COLLect:GUIDed:ETERms:LOAD[:CSET] <cset>,<calPort> [,csPort]`

Applicable Models: E5080A, M9485A

(Write-only) Loads 1-port error terms from a Cal Set into the current Guided Cal sequence. When the Cal steps are recomputed, connection steps are removed due to the loading of the error terms.

See example of how to use this command.

NOTE: Most users do not need this command.

Parameters

<ch> Channel being calibrated, depending on the [CHAN:MODE](#) setting. If unspecified,

value is set to 1.

<cset> **String** Name of User Cal Set in which the error terms reside.

<pnum> **Integer** Port number of the current cal to receive error terms.

[csPort] **Integer** Optional argument. Port number associated with the error terms in the Cal Set. If unspecified, the same port number as <calPort> is used.

Examples See example

Query Syntax Not Applicable

Default Not Applicable

SENSE<ch>:CORRection:COLLect:GUIDed:INITiate[:IMMEDIATE] [string][, bool][, char]

Applicable Models: E5080A, M9485A

(Write-only) Initiates a guided calibration.

- The VNA determines the measurements needed to perform the calibration using the settings specified from the [SENS:CORR:COLL:GUID:CONN:PORT](#) and [SENS:CORR:COLL:GUID:CKIT:PORT](#) commands.
- After this command is executed, subsequent commands can be used to query the number of measurement steps, issue the acquisition commands, query the connection description strings, and subsequently complete a guided calibration. See example calibration programs.

Parameters

<ch> Channel to be calibrated, depending on the [CHAN:MODE](#) setting. If unspecified, value is set to 1.

[string] Optional argument. Cal Set name or GUID enclosed in quotes.

If NOT specified, behavior depends on the [SENS:CORR:PREFerence:CSET:SAVE](#) setting.

If specified, choose an **existing** Cal Set, either by name or by GUID.

- By Cal Set name: include quotes.
- By Cal Set GUID in the form: "{GUID}"; including quotes and curly brackets.
- Query all Cal Set GUIDs with [SENS:CORR:CSET:CAT?](#)

An error is reported if the Cal Set is not found.

The Cal Set is either supplemented or overwritten depending on the method, connectors, and ports selected. [Learn more about Cal Sets.](#)

[bool] Optional argument. To set this argument, also set the first optional argument. See example below.

OFF (0) If Cal Set stimulus settings differ from the existing channel, do not change channel stimulus settings. The Cal Set is saved to the current setting of

the [SENS:CORR:PREF:CSET:SAVE](#) command. This is the default setting if not specified.

ON (1) If Cal Set stimulus settings differ from the existing channel, change the channel stimulus settings to match the Cal Set settings.

[char] Optional argument. To set this argument, also set the first two optional arguments. See example below.

SYNchronous - blocks further SCPI commands while processing this command.. (default setting).

ASYNchronous - does NOT block further SCPI commands while processing this command.

[Learn more about this argument](#)

Examples

```
SENS:CORR:COLL:GUID:INIT
'set first optional argument
SENS:CORR:COLL:GUID:INIT "MyCalSet"
'set two optional arguments
SENS:CORR:COLL:GUID:INIT " ",1
'set all optional arguments
SENS:CORR:COLL:GUID:INIT "MyCalSet",1,ASYN
```

Query Syntax Not Applicable

Default Not Applicable

SENSe<ch>:CORRection:COLLect:GUIDed:ISOLation:AVERage:INCRement <num>

Applicable Models: E5080A, M9485A

(Read-Write) Specifies amount to increment (increase) the channels averaging factor during measurement of isolation standards in a guided calibration.

Note: If the channel has averaging turned OFF and the value of <num> is greater than 1, averaging will be turned ON only during the isolation measurements and with the averaging factor equal to <num>.

Parameters

- <ch> Channel being calibrated, depending on the [CHAN:MODE](#) setting. If unspecified, value is set to 1.
- <num> Amount to increment the averaging factor for the isolation measurement. The maximum averaging factor for the channel is 65536 (2^{16}).

Examples

```
'Measure isolation on all paths for the cal
SENS:CORR:COLL:GUID:ISOL ALL
'Remove the port pairs 1-to-2 and 1-to-3 from the list of
paths on which to measure isolation
sense:correction:collect:guided:isolation:paths
REMOve,1,2,1,3
```

Query Syntax SENSE<ch>:CORREction:COLLect:GUIDed:ISOLation:AVERage:INCRement?

Return Type Numeric

Default 8 - If this command is NOT sent, but [isolation is measured](#), then averaging will be turned ON with factor set to 8 during the isolation measurements.

SENSE<ch>:CORREction:COLLect:GUIDed:ISOLation[:PATHs] <char>[,<p1a, p1b, p2a, p2b]

Applicable Models: E5080A, M9485A

(Read-Write) Specifies the paths (port pairs) to make isolation measurements on during a guided calibration.

Parameters

<ch> Channel being calibrated, depending on the [CHAN:MODE](#) setting. If unspecified, value is set to 1.

<char> **ALL** Measure isolation on all pairings of the ports that are to be calibrated.

NONE Do not measure isolation on any pairing of the ports to be calibrated. (Default behavior).

ADD Add one or more specific pairings of ports to the list of port pairings for which isolation will be measured.

REMOve Remove one or more specific pairings of ports from the list of port pairings for which isolation will be measured. If many paths are to be measured, it may be easier to first send ALL, then REMOve and specify the paths to remove.

<p1a, p2a...> For use when <char> is **ADD** or **REMOve**.

Specify Port numbers in pairs:

- For 3-port cals, specify up to 3 pairs.
- For 4-port cals, specify up to 6 pairs.

p1a, p1b (Path1 - port A and port B)

p2a, p2b (Path2 - port A and port B)

p3a, p3b (Path3 - port A and port B)

Examples

```
'Measure isolation on all paths for the cal
SENS:CORR:COLL:GUID:ISOL ALL

'Remove the port pairs 1-to-2 and 1-to-3 from the list of
paths on which to measure isolation
sense:correction:collect:guided:isolation:paths
REMOve,1,2,1,3
```

Query Syntax SENSE<ch>:CORRection:COLLect:GUIDed:ISOLation:PATHs?
Note: if isolation is not be measured on any of the paths, the query returns 0

Return Type Numeric

Default 0 - Isolation not measured on any paths.

SENSE<ch>:CORRection:COLLect:GUIDed:ITERations:COUNT? <step>

Applicable Models: E5080A, M9485A

(Read-only) Designed to be used for an iterative cal standard such as a sliding load, this command returns the number of iterative measurement acquisitions that has been made for the specified step.

Zero (0) is returned if the step has not yet been measured.

For most cal steps that have already been measured, this command returns 1.

Set [SENS:CORR:COLL:GUID:PREF:SLID ITER](#) to count acquisition steps.

Parameters

<ch> Channel being calibrated, depending on the [CHAN:MODE](#) setting. If unspecified, value is set to 1.

<step> Guided Cal step number for which the acquisition number will be returned.
 Use [SENS:CORR:COLL:GUID:STEP?](#) to query the number of steps in the calibration.

Examples

```
SENS:CORR:COLL:GUID:ITER:COUN? 4
'Example return:
5
See example program
```

Return Type Numeric

Default Not Applicable

SENSE<ch>:CORRection:COLLect:GUIDed:ITERations:MINimum? <step>

Applicable Models: E5080A, M9485A

(Read-only) Designed to be used for an iterative cal standard such as a sliding load, this command returns the minimum number of required iterative measurement acquisitions for the specified step.

For most connection steps this will return 1, but for an iterative cal standard such as a sliding load, it will return a number such as 5.

Set [SENS:CORR:COLL:GUID:PREF:SLID ITER](#) to count acquisition steps.

Parameters

- <ch> Channel being calibrated, depending on the [CHAN:MODE](#) setting. If unspecified, value is set to 1.
- <step> Guided Cal step number for which to return the number of iterative measurement acquisitions that have been made. Use [SENS:CORR:COLL:GUID:STEP?](#) to query the number of steps in the calibration.

Examples

```
SENS:CORR:COLL:GUID:ITER:MIN? 4
'Example return:
5
See example program
```

Return Type Numeric

Default Not Applicable

SENSe<ch>:CORRection:COLLect:GUIDed:ITERations:RESet <step>

Applicable Models: E5080A, M9485A

(Write-only) Resets the specified guided cal connection step as unmeasured. This clears all previous measurements made for that step.

Parameters

- <ch> Channel being calibrated, depending on the [CHAN:MODE](#) setting. If unspecified, value is set to 1.
- <step> Guided Cal step number to reset. Use [SENS:CORR:COLL:GUID:STEP?](#) to query the number of steps in the calibration.

Examples

```
SENS:CORR:COLL:GUID:ITER:RESet? 4
See example program
```

Return Type Not Applicable

Default Not Applicable

SENSe<ch>:CORRection:COLLect:GUIDed:PACQuire <std>

Applicable Models: E5080A, M9485A

(Write-only) Show the [Cal Window](#), and optionally one or more other specific windows before acquiring a Cal standard. This command will cause the Cal Window to display the specific measurements that are to be made for that particular Cal standard.

NOTE: Most users do not need this command.

Parameters

<ch> Channel being calibrated, depending on the [CHAN:MODE](#) setting. If unspecified, value is set to 1.

<std> Choose from: STAN1, STAN2, STAN3, through STAN40.

Examples

```
SENS:CORR:COLL:GUID:PACQuire STAN2
sense:correction:collect:guided:pacquire STAN5
```

See an example that uses this command.

Query Syntax Not Applicable

Default Not Applicable

SENSe<ch>:CORRection:COLLEct:GUIDed:PATH:CMETHod <port1>,<port2>,<caltype1[,caltype2]>

Applicable Models: E5080A, M9485A

(Read-Write) Specifies the calibration method for each port pair.

Note: Sending this command will overwrite the PNAs SmartCal determinations for the most accurate cal method for your connector settings and Cal Kits. Send this command ONLY if you have a deliberate reason for overwriting the SmartCal logic. You can send the query form of this command to learn the cal method determined by SmartCal.

See [Thru Pairs Sequence](#) to learn how to send this and other Thru commands.

After sending this command, send the query form to be sure that the command was accepted. If not, then the chosen Cal method is not compatible with the specified Thru method. For example, if the specified Thru method is Unknown Thru, an attempt to set Enhanced Response Cal should be rejected.

[Learn more about Thru Methods.](#)

Parameters

<ch> Channel being calibrated, depending on the [CHAN:MODE](#) setting. If unspecified, value is set to 1.

<port1> First port of the pair to be calibrated.

<port2> Second port of the pair to be calibrated.

<caltype1[caltype2]> (String) Cal type for the port pair, enclosed in a single pair of quotes. NOT case-sensitive.

caltype1 Choose from:

- TRL
- SOLT
- QSOLTN
- EnhRespN

For the last two arguments, replace **N** with the port to be used as the source port, which **MUST** be one of the port pair.

caltype2 Optional argument. Use only when performing an adapter removal cal on the pair. This argument specifies the Cal type on the second port. Caltype1 then specifies the Cal type of the first port.

Choose from the same arguments as caltype1.

Examples

```
SENS:CORR:COLL:GUID:PATH:CMETHOD 2,3,"QSOLT2"
sense:correction:collect:guided:path:cmethod 2,3,"solt,tr1"
```

Query Syntax

SENSe<ch>:CORRection:COLLect:GUIDed:PATH:CMETHOD? <port1>,<port2>
If only one caltype is returned then its NOT adapter removal.

Return Type

String

Default

The most accurate Cal method for the current cal.

SENSe<ch>:CORRection:COLLect:GUIDed:PATH:TMETHOD <port1>,<port2>,<thruType1[,thruType2]>

Applicable Models: E5080A, M9485A

(Read-Write) Specifies the calibration **THRU** method for each port pair.

Note: Sending this command will overwrite the VNAs SmartCal determination for the thru method. Send this command **ONLY** if you have a deliberate reason for overwriting the SmartCal logic. You can send the query form of this command to learn the THRU method determined by SmartCal.

See [Thru Pairs Sequence](#) to learn how to send this and other Thru commands.

[Learn more about Thru methods.](#)

Parameters

- <ch> Channel being calibrated, depending on the [CHAN:MODE](#) setting. If unspecified, value is set to 1.
- <port1> First port of the port pair to be calibrated.
- <port2> Second port of the port pair to be calibrated.
- <thruType1> (String) Thru methods for port pair, enclosed in a single pair of quotes. NOT case-sensitive.
Calibration Thru method. Choose from:
 - **Defined Thru** Measures a Thru for which there is a stored definition in

the Cal kit of the lowest-numbered port of the pair. For example, if the port pair is 1,2, then the cal kit for port 1 MUST contain a Defined Thru.

- **Zero Thru** Measures a Zero length Thru, also known as Flush-Thru.
- **Undefined Thru** (Also known as Unknown Thru) A Thru type for which there is NOT a stored definition in the Cal Kit. Valid ONLY for SOLT cal type.
- **Undefined Thru using a Defined Thru** (ECal modules ONLY) Measures the internal Thru as an Unknown Thru.

<thruType2> (String) Thru methods for port pair.

Optional argument. Use ONLY when Adapter Removal Cal is specified for the pair using [SENS:CORR:COLL:GUID:PATH:CMETHOD](#). When specifying ThruType2, this is the only valid argument: **"Defined Thru, Defined Thru"**

Examples

```
SENS:CORR:COLL:GUID:PATH:TMETHOD 2,3,"Zero Thru"
sense:correction:collect:guided:path:tmethod 2,3,"Defined Thru,Defined Thru"
```

Query Syntax

SENSE<ch>:CORREction:COLLect:GUIDed:PATH:TMETHOD? <port1>,<port2>

Always returns two parts:

If the second part of the string is empty, adapter removal is NOT being performed.

If the string is "Defined Thru, Defined Thru", adapter removal IS being performed.

If the string is set to "Zero Thru", query is returned as "Defined Thru"

Return Type String

Default The most accurate Thru method for the current cal.

SENSE<ch>:CORREction:COLLect:GUIDed:PREFERENCE:SLIDingload <char>

Applicable Models: E5080A, M9485A

(Read-Write) Specifies the behavior for guided cal steps that involve a sliding load in a cal that is about to be performed. Send this command BEFORE sending the Guided INIT command.

Although the term 'Preference' is used in the command, this is NOT a VNA preference. This setting does NOT survive instrument preset or reboot. It remains ONLY for the duration of the Guided Cal.

Parameters

<char> Behavior when measurements of sliding load are acquired. Choose from:

DIALog - The Sliding load dialog box appears when the acquire command is received for a sliding load step. All slide positions are measured (with a user-interface prompt) from a single invocation of the acquire command.

ITERate - Each invocation of the acquire command for a sliding load step measures a single slide position and increments the slide position counter. No Move Sliding Load prompt is presented on the VNA screen.

Examples `SENS:CORR:COLL:GUID:PREF:SLID ITER`
See example program

Query Syntax `SENSe<ch>:CORRection:COLLect:GUIDed:PREFeRence:SLIDingload?`

Return Type Character

Default DIALog

`SENSe<ch>:CORRection:COLLect:GUIDed:SAVE[:IMMEDIATE] [bool]`

Applicable Models: E5080A, M9485A

(Write-only) Completes the guided cal by computing the error correction terms, turning Correction ON, and saving the calibration to a Cal Set. If all of the required standards have not been measured, the calibration will not complete properly.

Parameters

<ch> Channel being calibrated, depending on the [CHAN:MODE](#) setting. If unspecified, value is set to 1.

[bool] Optional argument. If unspecified, the default behavior is the current VNA preference setting of [SENSe:CORRection:PREFeRence:CSET:SAVE](#)

OFF (0) Save cal data ONLY to a Cal Register.

ON (1) Save cal data to a Cal Register and a User Cal Set. The filename is automatically generated.

- For application channels (Gain Compression, SMC/VMC, Noise Figure, IMD and so forth), this command saves ONLY to a Cal Register. Use [SENS:CORR:CSET:COPY](#) to copy the cal register to a named calset.
- For a [Calibrate All Channels](#) session, this argument is ignored. Instead, use [SYST:CAL:ALL:CSET:PREFIX](#).

Examples `SENS:CORR:COLL:GUID:SAVE`
`sense2:correction:collect:guided:save:immediate 0`

Query Syntax Not Applicable

Default Not Applicable

`SENSe<ch>:CORRection:COLLect:GUIDed:SAVE:CSET <cal set name or guid>`

Applicable Models: E5080A, M9485A

(Write-only) Completes the guided cal by computing the error correction terms, turning Correction ON, and saving the calibration to an existing, specified Cal Set. This command performs the same function as [SENSe:CORRection:COLLect:GUIDed:SAVE](#), except this command allows the name or GUID of the Cal Set to be specified.

Note: This command is NOT supported for application channels (Gain Compression, SMC/VMC, Noise Figure, IMD and so forth). Use [SENS:CORR:COLL:GUID:SAVE](#) and save to a cal register. You can then use [SENS:CORR:CSET:COPY](#) to copy the cal register to a named calset.

- Use this command instead of specifying the optional name or GUID argument in [SENS:CORR:COLL:GUID:INIT](#).
- Use [SENS:CORRection:CSET](#) commands to get names or GUIDs of existing Cal Sets.
- The cal data is also saved to the channel Cal Register.
- If all of the required standards have not been measured, the calibration will not complete properly.

For Calibrate All Channels

When this command is used during a Cal All session, the <cal set name> argument sets the User Cal Set prefix. All generated Cal Sets will be preceded with this string name.

- Cal Set prefix can also be set using [SYST:CAL:ALL:CSET:PREFIX](#). When the Cal Set prefix has already been set with [SYST:CAL:ALL:CSET:PREFIX](#), this command overwrites it.
- When <cal set name> is an empty string, a User Cal Set will not be saved. Only Cal Registers will be saved.

Parameters

- <ch> Channel being calibrated, depending on the [CHAN:MODE](#) setting. If unspecified, value is set to 1.
- <cal set name or guid> **String** - Name or GUID of an existing Cal Set to be overwritten. If specifying a GUID, curly brackets must be included.
See [Calibrate All Channels](#) note (above).

Examples

```
SENS:CORR:COLL:GUID:SAVE:CSET "{2B893E7A-971A-11d5-8D6C-00108334AE96}"
sense:correction:collect:guided:save:cset "MyCalSet"
```

Query Syntax Not Applicable

Default Not Applicable

SENSe<ch>:CORRection:COLLect:GUIDed:STEPs?

Applicable Models: E5080A, M9485A

(Read-only) Returns the number of measurement steps required to complete the current guided calibration. This command is sent after the [SENS:CORR:COLL:GUID:INIT](#), [SENS:CORR:COLL:GUID:CONN:PORT](#) and [SENS:CORR:COLL:GUID:CKIT:PORT](#) commands.

Parameters

- <ch> Any existing channel number. If unspecified, value is set to 1.

Examples

```
SENS:CORR:COLL:GUID:STEP?
sense2:correction:collect:guided:steps?
```

Return Type Numeric

Default Not Applicable

SENSE<ch>:CORREction:COLLect:GUIDed:THRU:PORTs <t1a, t1b, t2a, t2b, t3a, t3b...>

Applicable Models: E5080A, M9485A

(Read-Write) For calibrating more than 2-ports ONLY. Specifies the port pairs for the Thru connections of the calibration. Send the query form of this command to learn the Thru pairs determined by SmartCal.

Note: Sending this command will overwrite the PNAs SmartCal determinations for the thru ports. Send this command ONLY if you have a deliberate reason for overwriting the SmartCal logic.

See [Thru Pairs Sequence](#) to learn how to send this and other Thru commands.

Parameters

<ch> Channel being calibrated, depending on the [CHAN:MODE](#) setting. If unspecified, value is set to 1.

<t1a,t1b...> Always specify port numbers in pairs: For example: 1,2 or 1,2,1,3

- For 3-port cals, specify two or three pairs.
- For 4-port cals, specify from three up to six pairs.

Examples

```
SENS:CORR:COLL:GUID:THRU:PORT 1,2,1,3,1,4 '4-port
measurement
sense:correction:collect:guided:thru:ports 1,2,2,3 '3-port
measurement
```

Query Syntax SENSE<ch>:CORREction:COLLect:GUIDed:THRU:PORTs?

Return Type Numeric

Default Port pairings that were used in the previous cal.

THRU Pairs sequence

The SmartCal logic always determines the best calibration based on your specified connectors and ports.

The following three commands overwrite the SmartCal logic. Send these commands ONLY if you have a deliberate reason for overwriting the SmartCal logic.

- [SENS:CORR:COLL:GUID:THRU:PORTS](#) <p1, p2>
- [SENS:CORR:COLL:GUID:PATH:TMET](#) <p1,p2, thrutype>
- [SENS:CORR:COLL:GUID:PATH:CMET](#) <p1,p2, calmethod>

When sending one or more of these commands, they must be sent in the following sequence with the other commands listed here.

Note: The **GUID:INIT** command is sent before and after these commands.

1. [SENS:CORR:COLL:GUID:CONN:PORT\(N\)](#)

E5080A

2. [SENS:CORR:COLL:GUID:CKIT:PORT\(N\)](#)
 3. [SENS:CORR:COLL:GUID:INIT](#)
 4. [SENS:CORR:COLL:GUID:THRU:PORTS](#) <P1, P2>
 5. [SENS:CORR:COLL:GUID:PATH:TMET](#) <P1,P2, THRUTYPE>
 6. [SENS:CORR:COLL:GUID:PATH:CMET](#) <P1,P2, CALMETHOD>
 7. [SENS:CORR:COLL:GUID:PATH:CMET?](#) <P1,P2> (RECOMMENDED)
 8. [SENS:CORR:COLL:GUID:INIT](#)
-

Last modified:

18-Mar-2015 First release



Sense:Couple Commands

SENSe:COUPlE

 |
PARAmeter

 |
[STATe]

SENSe:COUPlE:
[PARAmeter\[STATe\]](#)

Click on a **Red** keyword to view the command details.

See Also

- Example Programs
- [Synchronizing the VNA and Controller](#)
- [SCPI Command Tree](#)

SENSe<num>:COUPlE:PARAmeter[:STATe] <bool>

Applicable Models: E5080A, M9485A

(Read-Write) Turns ON and OFF Time Domain Trace Coupling. All of the measurements in the specified channel are coupled.

- To select Transform parameters to couple, use [CALC:TRAN:COUP:PAR](#)
- To select Gating parameters to couple, use [CALC:FILT:COUP:PAR](#)

Learn more about Time Domain Trace Coupling.

Parameters

- <num> Any existing channel number; if unspecified, value is set to 1.
- <bool> **ON or 1** - Turns ON Time Domain Trace Coupling.
OFF or 0 - Turns OFF Time Domain Trace Coupling.

Examples `SENSe:COUP:PAR 0`
`sense2:couple:parameter:state on`

Query Syntax `SENSe<num>:COUPlE:PARAmeter[:STATe]?`

Return Type Boolean

Default ON or 1

E5080A

Last Modified:

29-Sep-2015 First Release

Sense:FOM (Frequency Offset) Commands

Controls the frequency offset settings which cause stimulus and response frequencies to be different.

Note: These commands replace the previous FOM commands. Although the old commands will continue to work, they can NOT be mixed with these new commands.

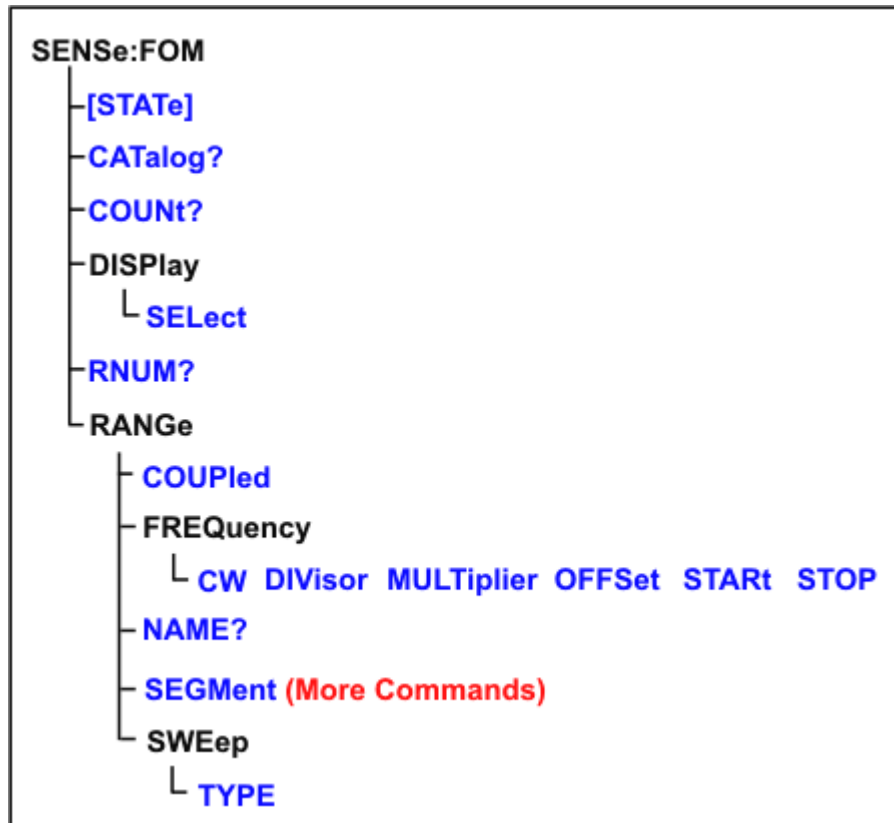

SENSE:FOM:[CATalog?](#)[COUNT?](#)

DISPlay

| [SElect](#)[RNUM?](#)[\[STATe\]](#)

RANGe

| [COUPled](#)

| FREQuency

| [CW](#)| [DIVisor](#)| [MULTiplier](#)| [OFFSet](#)| [STARt](#)| [STOP](#)| [NAME | NAME?](#)| [SEGment](#) More Commands| [SWEp:TYPE](#)

Click on a **Red** keyword to view the command details.

See Also

- FOM Example Program
- Learn about Frequency Offset
- [Synchronizing the VNA and Controller](#)
- [SCPI Command Tree](#)

SENSe<cnum>:FOM:CATalog?**Applicable Models:** E5080A, M9485A

(Read-only) Returns a comma-separated list of available range names in the VNA.

Use [SENSe:FOM:CAT?](#) to see a list of available range names.

Use [SENSe:FOM:COUNT?](#) to see a list of available range numbers.

Use [SENSe:FOM:RNUM?](#) to see the range number for a specific name.

Use [SENSe:FOM:RANG:NAME?](#) to see the range name for a specific number.

External devices can appear in the list of range names. [Learn more.](#)

Parameters

<cnum> Any existing channel number; if unspecified, value is set to 1.

Examples `SENS:FOM:CAT?`
returns
`"Primary, Source, Receivers"`

Return Type String

Default Not Applicable

SENSe<cnum>:FOM:COUNT?

Applicable Models: E5080A, M9485A

(Read-only) Returns the number of valid range numbers in the VNA.

Parameters

<cnum> Any existing channel number; if unspecified, value is set to 1.

Examples `SENS:FOM:COUNT?`
`sense2:fom:count?`

Query Syntax `SENSe<cnum>:FOM:COUNT?`

Return Type Numeric

Default Not Applicable

SENSe<cnum>:FOM:DISPlay:SElect <string>

Applicable Models: E5080A, M9485A

(Read-Write) Select the range to be displayed on the VNA x-axis. All traces in the channel have this same x-axis scaling.

Parameters

<cnum> Any existing channel number; if unspecified, value is set to 1.

<string> Range name. Case insensitive. Use [SENSe:FOM:CAT?](#) to see a list of available frequency range names.

Examples `SENS:FOM:DISPlay:SElect "source2"`
`sense2:fom:display:select "source"`

Query Syntax `SENSe<cnum>:FOM:DISPlay:SElect?`

Return Type String

Default Receivers

SENSe<cnum>:FOM:RNUM? <string>

Applicable Models: E5080A, M9485A

(Read-only) Returns the number of a specified range name.

Use [SENS:FOM:CAT?](#) to see a list of available range names.

Use [SENS:FOM:COUNt?](#) to see a list of available range numbers.

Use [SENS:FOM:RANG:NAME?](#) to see the range name for a specific number.

External devices can appear in the list of range names. [Learn more.](#)

Parameters

<cnum> Any existing channel number; if unspecified, value is set to 1.

<string> Range name for which a number is being queried. Case insensitive.

The FOM range items are typically numbered as follows:

1. Primary
2. Source
3. Receivers
4. Source2 (if present)

Examples `SENS:FOM:RNUM? "receivers"`
`sense2:fom:rnum? "Source2"`

Return Type Numeric

Default Not Applicable

SENSe<cnum>:FOM[:STATe] <bool>

Applicable Models: E5080A, M9485A

(Read-Write) Turns Frequency Offset ON and OFF. Frequency offset settings are not enabled until this setting is ON.

Send this command (FOM ON) AFTER sending other FOM settings to avoid 'out-of-range' errors.

Parameters

<cnum> Any existing channel number; if unspecified, value is set to 1.

<bool> **ON or 1** - Turns FOM ON.
OFF or 0 - Turns FOM OFF.

Examples `SENS:FOM 1`
`sense2:fom:state on`

Query Syntax `SENSe<cnum>:FOM:STATe?`

Return Type Boolean

Default OFF

SENSe<cnum>:FOM:RANGe<n>:COUPlEd <bool>

Applicable Models: E5080A, M9485A

(Read-Write) Sets and returns the state of coupling (ON or OFF) of the specified range to the primary range.

Parameters

<cnum> Any existing channel number; if unspecified, value is set to 1.

<n> Range number to couple to primary range. An error is returned when attempting to couple to the Primary range (1).

Use [SENS:FOM:CAT?](#) to see a list of available range names.

Use [SENS:FOM:COUNT?](#) to see a list of available range numbers.

Use [SENS:FOM:RNUM?](#) to see the range number for a specific name.

Use [SENS:FOM:RANG:NAME?](#) to see the range name for a specific number.

<bool> **ON or 1** - Couple range to primary range.
OFF or 0 - Do NOT couple to primary range.

Examples `SENS:FOM:RANG:COUP 1`
`sense2:fom:range2:coupled 0`

Query Syntax `SENSe<cnum>:FOM:RANGe<n>:COUPlEd?`

Return Type Boolean

Default ON (or 1) Coupled

SENSe<cnum>:FOM:RANGe<n>:FREQUency:CW <num>

Applicable Models: E5080A, M9485A

(Read-Write) Sets and returns the CW frequency.

This setting is valid for the primary range, or if the specified range is already [uncoupled](#) from the primary range and if the [sweep type](#) is CW.

Parameters

- <cnm> Any existing channel number; if unspecified, value is set to 1.
- <n> Range number. If unspecified, value is set to 1.
 Use [SENS:FOM:CAT?](#) to see a list of available range names.
 Use [SENS:FOM:COUNT?](#) to see a list of available range numbers.
 Use [SENS:FOM:RNUM?](#) to see the range number for a specific name.
 Use [SENS:FOM:RANG:NAME?](#) to see the range name for a specific number.
- <num> CW frequency value in Hz. Choose any frequency within the range of the VNA.

Examples

```
SENS:FOM:RANG:FREQ: CW 1e9
sense2:fom:range2:frequency:cw 10000000
```

Query Syntax SENSE<cnm>:FOM:RANGe:<n>:FREQUency: CW?

Return Type Numeric

Default Center frequency of the VNA.

SENSe<cnm>:FOM:RANGe<n>:FREQUency:DIVisor <num>

Applicable Models: E5080A, M9485A

(Read-Write) Sets and returns the divisor value.

This setting is valid only if the specified range is [coupled](#) to the primary range.

Parameters

- <cnm> Any existing channel number; if unspecified, value is set to 1.
- <n> Range number. If unspecified, value is set to 1.
 Use [SENS:FOM:CAT?](#) to see a list of available range names.
 Use [SENS:FOM:COUNT?](#) to see a list of available range numbers.
 Use [SENS:FOM:RNUM?](#) to see the range number for a specific name.
 Use [SENS:FOM:RANG:NAME?](#) to see the range name for a specific number.
- <num> Divisor value (unitless).

Examples

```
SENS:FOM:RANG:FREQ: DIV 3
```

```
sense2:fom:range2:frequency:divisor 0
```

Query Syntax SENSE<cnum>:FOM:RANGe<n>:FREQUency:DIVisor?

Return Type Numeric

Default 1

SENSe<cnum>:FOM:RANGe<n>:FREQUency:MULTiplier <num>

Applicable Models: E5080A, M9485A

(Read-Write) Sets and returns the multiplier value to be used when coupling this range to the primary range.

This setting is valid only if the specified range is [coupled](#) to the primary range.

Parameters

<cnum> Any existing channel number; if unspecified, value is set to 1.

<n> Range number. If unspecified, value is set to 1.

Use [SENS:FOM:CAT?](#) to see a list of available range names.

Use [SENS:FOM:COUNT?](#) to see a list of available range numbers.

Use [SENS:FOM:RNUM?](#) to see the range number for a specific name.

Use [SENS:FOM:RANG:NAME?](#) to see the range name for a specific number.

<num> Multiplier value. (Unitless)

Examples

```
SENS:FOM:RANG:FREQ:MULT 1
sense2:fom:range2:frequency:multiplier 2
```

Query Syntax SENSE<cnum>:FOM:RANGe<n>:FREQUency:MULTplier?

Return Type Numeric

Default 1

SENSe<cnum>:FOM:RANGe<n>:FREQUency:OFFSet <num>

Applicable Models: E5080A, M9485A

(Read-Write) Sets and returns the offset value to be used when coupling this range to the primary range. Learn more about offset value.

This setting is valid only if the specified range is [coupled](#) to the primary range.

Parameters

- <cnm> Any existing channel number; if unspecified, value is set to 1.
- <n> Range number. If unspecified, value is set to 1.
 Use [SENS:FOM:CAT?](#) to see a list of available range names.
 Use [SENS:FOM:COUNT?](#) to see a list of available range numbers.
 Use [SENS:FOM:RNUM?](#) to see the range number for a specific name.
 Use [SENS:FOM:RANG:NAME?](#) to see the range name for a specific number.
- <num> Offset value. (Unitless)

Examples

```
SENS:FOM:RANG:FREQ:OFFS 1E9
sense2:fom:range2:frequency:offset 10000000
```

Query Syntax SENSE<cnm>:FOM:RANGe<n>:FREQUency:OFFSet?

Return Type Numeric

Default 0

SENSe<cnm>:FOM:RANGe<n>:FREQUency:STARt <num>

Applicable Models: E5080A, M9485A

(Read-Write) Sets and returns the Start value of frequency range. Also specify [Stop frequency](#).

This setting is valid for the primary range, or if the specified range is already [uncoupled](#) from the primary range and if the [sweep type](#) is LOG or LINear.

Parameters

- <cnm> Any existing channel number; if unspecified, value is set to 1.
- <n> Range number. If unspecified, value is set to 1.
 Use [SENS:FOM:CAT?](#) to see a list of available range names.
 Use [SENS:FOM:COUNT?](#) to see a list of available range numbers.
 Use [SENS:FOM:RNUM?](#) to see the range number for a specific name.
 Use [SENS:FOM:RANG:NAME?](#) to see the range name for a specific number.
- <num> Start value in Hz. Choose any frequency within the range of the VNA.

Examples

```
SENS:FOM:RANG:FREQ:STAR 1GHz
sense2:fom:range2:frequency:start 100000000
```

Query Syntax SENSE<cnm>:FOM:RANGe<n>:FREQUency:STARt?

Return Type Numeric

Default Minimum frequency of the VNA.

SENSe<cnm>:FOM:RANGe<n>:FREQuency:STOP <num>

Applicable Models: E5080A, M9485A

(Read-Write) Sets and returns the Stop value of frequency range. Also specify [Start frequency](#).

This setting is valid for the primary range, or if the specified range is already [uncoupled](#) from the primary range and if the [sweep type](#) is LOG or LINear.

Parameters

- <cnm> Any existing channel number; if unspecified, value is set to 1.
- <n> Range number. If unspecified, value is set to 1.
 Use [SENS:FOM:CAT?](#) to see a list of available range names.
 Use [SENS:FOM:COUNt?](#) to see a list of available range numbers.
 Use [SENS:FOM:RNUM?](#) to see the range number for a specific name.
 Use [SENS:FOM:RANG:NAME?](#) to see the range name for a specific number.
- <num> Stop value in Hz. Choose any frequency within the range of the VNA.

Examples

```
SENS:FOM:RANG:FREQ:STOP 1e12
sense2:fom:range2:frequency:stop 10000000000
```

Query Syntax SENSe<cnm>:FOM:RANGe<n>:FREQuency:STOP?

Return Type Numeric

Default Maximum frequency of the VNA.

SENSe<cnm>:FOM:RANGe<n>:NAME | NAME?

Applicable Models: E5080A, M9485A

(Read-only) Returns the name of range<n>.

The FOM range items are typically named as follows:

1. Primary
2. Source
3. Receivers
4. Source2 (if present)

Use [SENS:FOM:CAT?](#) to see a list of available range names.

Use [SENS:FOM:COUNt?](#) to see a list of available range numbers.

Use [SENS:FOM:RNUM?](#) to see the range number for a specific name.

Parameters

<cnm> Any existing channel number; if unspecified, value is set to 1.

<n> Range number. If unspecified, value is set to 1.

Examples

```
SENS:FOM:RANG:NAME?
sense2:fom:range2:name?
```

Return Type String

Default Not Applicable

SENSe<cnm>:FOM:RANGe<n>:SWEep:TYPE <char>

Applicable Models: E5080A, M9485A

(Read-Write) Sets and returns the sweep type to be used with the specified range.

This setting is valid only if the specified range is already [uncoupled](#) from the primary range.

Learn about Unsupported Sweep Type combinations.

Parameters

<cnm> Any existing channel number; if unspecified, value is set to 1.

<n> Range number. If unspecified, value is set to 1.

Use [SENS:FOM:CAT?](#) to see a list of available range names.

Use [SENS:FOM:COUNT?](#) to see a list of available range numbers.

Use [SENS:FOM:RNUM?](#) to see the range number for a specific name.

Use [SENS:FOM:RANG:NAME?](#) to see the range name for a specific number.

<char> Sweep type. Choose from:

CW - Also specify [CW frequency](#).

LINEar - Also specify frequency Start/Stop or Center/Span

LOG - Also specify frequency Start/Stop or Center/Span

PHASe - See all Phase sweep settings.

POWER - Also specify power Start/Stop or Center/Span

SEGMENT - Also specify [segment sweep](#) settings.

Examples

```
SENS:FOM:RANG:SWE:TYPE LOG
sense2:fom:range2:sweep:type linear:
```

Query Syntax SENSe<cnm>:FOM:RANGe<n>:SWEep:TYPE?

Return Type Character

Default Linear

Last Modified:

29-Sep-2015 First Release

Sense:FOM:Range:Segment Commands

Constructs a segment table for a specified [UNCOUPLED](#) FOM range.

Note: Do NOT use [Sens:Segment](#) commands for FOM segment sweep.

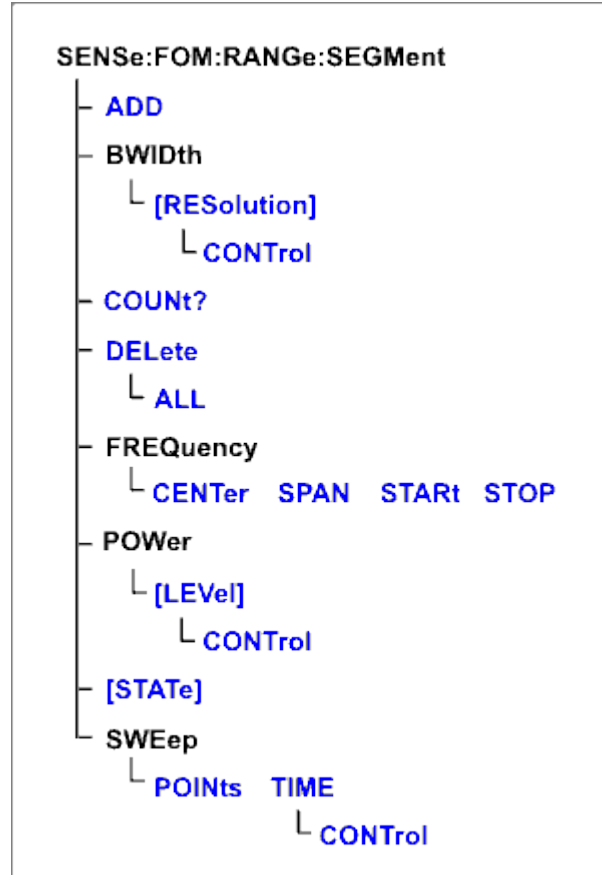

SENSE:FOM:RANGE:SEGMENT:[ADD](#)[BWIDth\[RESolution\]](#)[BWIDth\[RESolution\]:CONTrol](#)[COUNT?](#)[DELete](#)| [ALL](#)**FREQuency**| [CENTer](#)| [SPAN](#)| [START](#)| [STOP](#)[POWer\[LEVel\]](#)| [CONTrol](#)[\[STATe\]](#)**SWEep**| [POINts](#)| [TIME](#)| [CONTrol](#)

Click on a [Red](#) keyword to view the command details.

See Also

- [Other SENSE:FOM Commands](#)
- Example Programs
- [Synchronizing the VNA and Controller](#)
- [SCPI Command Tree](#)

SENSE<num>:FOM:RANGE<n>:SEGMENT<s>:ADD**Applicable Models:** E5080A, M9485A**(Write-only)** Adds a segment.**Parameters**

- <num> Any existing channel number; if unspecified, value is set to 1.
- <n> Range number. If unspecified, value is set to 1.
- <s> Segment number to add. If unspecified, value is set to 1. Segment numbers must be sequential. If a new number is added where one currently exists, the existing

segment and those following are incremented by one.

Examples Two Segments exist (1 and 2). The following command will add a new segment (1). The existing (1 and 2) will become (2 and 3) respectively.

```
sense2:fom:range2:segment:add
```

Query Syntax Not Applicable

Default Not Applicable

SENSe<cnum>:FOM:RANGe<n>:SEGMENT<s>:BWIDth[:RESolution] <num>

Applicable Models: E5080A, M9485A

(Read-Write) Sets the IF Bandwidth for the specified segment. First set [SENS:FOM:RANGe:SEGM:BWIDth:CONTRol ON](#). All subsequent segments that are added assume the new IF Bandwidth value.

Valid either for Receiver range or for Primary range when coupled to Receiver.

Parameters

<cnum> Any existing channel number; if unspecified, value is set to 1.

<n> Range number. If unspecified, value is set to 1.

<s> Segment number for which to set independent IF Bandwidth.

<num> IF Bandwidth in Hz. The list of valid IF Bandwidths is different depending on the VNA model. [See the list of valid IFBW values](#). If an invalid number is specified, the analyzer will round up to the closest valid number.

Examples

```
SENS:FOM:RANG:SEGM:BWIDth 100
sense2:fom:range2:segment4:bwidth:resolution 1e3
```

Query Syntax SENSe<cnum>:FOM:RANGe<n>:SEGMENT<s>:BWIDth[:RESolution]?

Return Type Numeric

Default Varies with model.

SENSe<cnum>:FOM:RANGe<n>:SEGMENT:BWIDth[:RESolution]:CONTRol <bool>

Applicable Models: E5080A, M9485A

(Read-Write) Specifies whether the IF Bandwidth resolution can be set independently for each segment. When set, each segment added after this will be set to ON automatically.

Valid either for Receiver range or for Primary range. Primary range value is ignored unless Receiver is

coupled to Primary.

Parameters

- <cnm> Any existing channel number; if unspecified, value is set to 1.
- <n> Range number. If unspecified, value is set to 1.
- <bool> **ON** (or 1) - turns Bandwidth control ON. Bandwidth can be set for each segment
OFF (or 0) - turns Bandwidth control OFF. Use the channel IF bandwidth setting instead.

Examples

```
SENS:FOM:RANG:SEGM:BWIDth:CONT 0
sense2:fom:range2:segment:bwidth:resolution:control 1
```

Query Syntax SENSE<cnm>:FOM:RANGe<n>:SEGMENT:BWIDth[:RESolution]:CONTrol?

Return Type Boolean

Default OFF

SENSe<cnm>:FOM:RANGe<n>:SEGMENT:COUNT?

Applicable Models: E5080A, M9485A

(Read-only) Returns the number of segments that exist for the specified range.

Parameters

- <cnm> Any existing channel number; if unspecified, value is set to 1.
- <n> Range number. If unspecified, value is set to 1.

Examples

```
SENS:FOM:RANG:SEGM:COUN?
sense2:fom:range2:segment:count?
```

Return Type Numeric

Default Not Applicable

SENSe<cnm>:FOM:RANGe<n>:SEGMENT<s>:DELete

Applicable Models: E5080A, M9485A

(Write-only) Deletes the specified sweep segment.

Parameters

- <cnum> Any existing channel number; if unspecified, value is set to 1.
- <n> Range number. If unspecified, value is set to 1.
- <s> Number of the segment to delete. If unspecified, value is set to 1.

Examples `SENS:FOM:RANG:SEGM3:DEL`
`sense2:fom:range2:segment4:delete`

Query Syntax Not Applicable

Default Not Applicable

SENSe<cnum>:FOM:RANGe<n>:SEGMENT:DELete:ALL

Applicable Models: E5080A, M9485A

(Write-only) Deletes all sweep segments in the specified range.

Parameters

- <cnum> Any existing channel number; if unspecified, value is set to 1.
- <n> Range number. If unspecified, value is set to 1.

Examples `SENS:FOM:RANG:SEGM:DEL:ALL`
`sense2:fom:range2:segment:delete:all`

Query Syntax Not Applicable

Default Not Applicable

SENSe<cnum>:FOM:RANGe<n>:SEGMENT<s>:FREQUency:CENTer <num>

Applicable Models: E5080A, M9485A

(Read-Write) Sets and returns the center frequency for the specified sweep segment. Also specify segment frequency span.

Parameters

- <cnum> Any existing channel number; if unspecified, value is set to 1.
- <n> Range number. If unspecified, value is set to 1.
- <s> Segment number to modify. Choose any existing segment number.
- <num> Center Frequency in Hz. Choose any number between the minimum and maximum

frequency of the analyzer.

Examples `SENS:FOM:RANG:SEGM:FREQ:CENT 1GHz`
`sense2:fom:range2:segment4:frequency:center 1e9`

Query Syntax `SENSe<num>:FOM:RANGe<n>:SEGMENT<s>:FREQUENCY:CENTer?`

Return Type Numeric

Default Stop Frequency of the previous segment. If first segment, start frequency of the analyzer.

SENSe<num>:FOM:RANGe<n>:SEGMENT<s>:FREQUENCY:SPAN <num>

Applicable Models: E5080A, M9485A

(Read-Write) Sets and returns the span frequency for the specified sweep segment. Also specify segment center frequency.

Parameters

- <num> Any existing channel number; if unspecified, value is set to 1.
- <n> Range number. If unspecified, value is set to 1.
- <s> Segment number to modify. Choose any existing segment number.
- <num> Frequency span in Hz. Choose any number between the minimum and maximum frequency of the analyzer.

Examples `SENS:FOM:RANG:SEGM:FREQ:SPAN 1GHz`
`sense2:fom:range2:segment4:frequency:span 1e9`

Query Syntax `SENSe<num>:FOM:RANGe<n>:SEGMENT<s>:FREQUENCY:SPAN?`

Return Type Numeric

Default If first segment, frequency span of the analyzer. Otherwise 0.

SENSe<num>:FOM:RANGe<n>:SEGMENT<s>:FREQUENCY:START <num>

Applicable Models: E5080A, M9485A

(Read-Write) Sets and returns the start frequency for the specified sweep segment. Also specify segment stop frequency.

All other segment Start and Stop Frequency values that are larger than this frequency are changed to this frequency.

Parameters

- <cnm> Any existing channel number; if unspecified, value is set to 1.
- <n> Range number. If unspecified, value is set to 1.
- <s> Segment number to modify. Choose any existing segment number.
- <num> Start frequency in Hz. Choose any number between the minimum and maximum frequency of the analyzer.

Examples

```
SENS:FOM:RANG:SEGM:FREQ:STAR 1GHz
sense2:fom:range2:segment4:frequency:start 1e9
```

Query Syntax SENSE<cnm>:FOM:RANGe<n>:SEGMent<s>:FREQUency:STARt?

Return Type Numeric

Default Stop Frequency of the previous segment. If first segment, start frequency of the analyzer.

SENSE<cnm>:FOM:RANGe<n>:SEGMent<s>:FREQUency:STOP <num>

Applicable Models: E5080A, M9485A

(Read-Write) Sets and returns the stop frequency for the specified sweep segment. Also specify segment start frequency.

All other segment Start and Stop Frequency values that are larger than this frequency are changed to this frequency.

Parameters

- <cnm> Any existing channel number; if unspecified, value is set to 1.
- <n> Range number. If unspecified, value is set to 1.
- <s> Segment number to modify. Choose any existing segment number.
- <num> Stop frequency in Hz. Choose any number between the minimum and maximum frequency of the analyzer.

Examples

```
SENS:FOM:RANG:SEGM:FREQ:STOP 1GHz
sense2:fom:range2:segment4:frequency:stop 1e9
```

Query Syntax SENSE<cnm>:FOM:RANGe<n>:SEGMent<s>:FREQUency:STOP?

Return Type Numeric

Default Stop Frequency of the previous segment. If first segment, start frequency of the analyzer.

SENSe<cnum>:FOM:RANGe<n>:SEGMENT<s>:POWER<p>[:LEVel] <num>

Applicable Models: E5080A, M9485A

(Read-Write) Sets the Port Power level for the specified sweep segment. First set SENS:FOM:RANG:SEGM:POW:CONTRol ON.

When [port power is Coupled](#), setting port power for one port will apply port power for all source ports.

All subsequent segments that are added assume the new Power Level value.

Valid either for Source ranges or for Primary range when [coupled](#) to the source.

Parameters

<cnum> Any existing channel number; if unspecified, value is set to 1.

<n> Range number. If unspecified, value is set to 1.

<s> Segment number to modify. Choose any existing segment number.

<p> Port number of the source. If unspecified, value is set to 1.

<num> Power level in dBm.

Note: The range of settable power values depends on the VNA model and if source attenuators are installed. To determine the range of values, send SOUR:POW? MAX and SOUR:POW? MIN. ([SOUR:POW:ATT:AUTO](#) must be set to ON).

Actual achievable leveled power depends on frequency.

Examples

```
SENS:FOM:RANG:SEGM:POW -5
```

```
sense2:fom:range2:segment4:power2:level 5
```

Query Syntax SENSe<cnum>:FOM:RANGe<n>:SEGMENT<s>:POWER<p>[:LEVel]?

Return Type Numeric

Default 0

SENSe<cnum>:FOM:RANGe<n>:SEGMENT:POWER[:LEVel]:CONTRol <bool>

Applicable Models: E5080A, M9485A

(Read-Write) Specifies whether Power Level is to be set independently for each segment.

Valid either for Source ranges or for Primary range. Primary range value is ignored unless Source is [coupled](#) to Primary.

Parameters

- <cnm> Any existing channel number; if unspecified, value is set to 1.
- <n> Range number. If unspecified, value is set to 1.
- <bool> ON (or 1) - Power level will be set for each segment.
OFF (or 0) - Use the channel power level setting.

Examples

```
SENS:FOM:RANG:SEGM:POW:CONT 0
sense2:fom:range2:segment:power:control on
```

Query Syntax SENSE<cnm>:FOM:RANGe<n>:SEGMENT:POWER[:LEVel]:CONTrol?

Return Type Boolean

Default OFF (or 0)

SENSe<cnm>:FOM:RANGe<n>:SEGMENT<s>[:STATe] <bool>

Applicable Models: E5080A, M9485A

(Read-Write) Turns the specified sweep segment ON or OFF.

Parameters

- <cnm> Any existing channel number; if unspecified, value is set to 1.
- <n> Range number. If unspecified, value is set to 1.
- <s> Segment number to be turned ON or OFF. Choose any existing segment number.
- <bool> ON (or 1) - turns segment ON.
OFF (or 0) - turns segment OFF.

Examples

```
SENS:FOM:RANG:SEGM 0
sense2:fom:range2:segment4:state on
```

Query Syntax SENSE<cnm>:FOM:RANGe<n>:SEGMENT<s>[STATe]?

Return Type Boolean

Default OFF (or 0)

SENSe<cnm>:FOM:RANGe<n>:SEGMENT<s>:SWEep:POINTs <num>

Applicable Models: E5080A, M9485A

(Read-Write) Sets the number of data points for the specified sweep segment.

Parameters

- <cnm> Any existing channel number; if unspecified, value is set to 1.
- <n> Range number. If unspecified, value is set to 1.
- <s> Segment number to modify. Choose any existing segment number.
- <num> Number of points in the segment. The total number of points in all segments cannot exceed 20001. A segment can have as few as 1 point.

Examples

```
SENS:FOM:RANG:SEGM:SWE:POIN 101
sense2:fom:range2:segment4:sweep:points 201
```

Query Syntax SENSE<cnm>:FOM:RANGe<n>:SEGMENT<s>:SWEep:POINTs?

Return Type Numeric

Default 21

SENSE<cnm>:FOM:RANGe<n>:SEGMENT<s>:SWEep:TIME <num>

Applicable Models: E5080A, M9485A

(Read-Write) Sets the time the VNA takes to sweep the specified segment.

Valid ONLY for receiver ranges.

Parameters

- <cnm> Any existing channel number; if unspecified, value is set to 1.
- <n> Range number. If unspecified, value is set to 1.
- <s> Segment number for which to set sweep time.
- <num> Sweep time in seconds. Choose a number between 0 and 100

Examples

```
SENS:FOM:RANG:SEGM:SWE:TIME 1
sense2:fom:range2:segment3:sweep:time .1
```

Query Syntax SENSE<cnm>:FOM:RANGe<n>:SEGMENT<s>:SWEep:TIME?

Return Type Numeric

Default Not Applicable

SENSe<cnum>:FOM:RANGe<n>:SEGMENT:SWEep:TIME:CONTRol <bool>

Applicable Models: E5080A, M9485A

(Read-Write) Specifies whether Sweep Time can be set independently for each sweep segment.

Valid either for Receiver ranges or for Primary range. Primary range value is ignored unless Receiver is [coupled](#) to Primary.

Parameters

<cnum> Any existing channel number; if unspecified, value is set to 1.

<n> Range number. If unspecified, value is set to 1.

<bool> **ON** (or 1) - Sweep time will be set for each segment.
OFF (or 0) - Use the channel sweep time setting.

Examples

```
SENS:FOM:RANG:SEGM:SWE:TIME:CONT 1
sense2:fom:range2:segment:sweep:time:control off
```

Query Syntax SENSe<cnum>:FOM:RANGe<n>:SEGMENT:SWEep:TIME:CONTRol?

Return Type Boolean

Default OFF

Last Modified:

29-Sep-2015 First Release

Sense:Frequency Commands

Sets the frequency sweep functions of the analyzer.

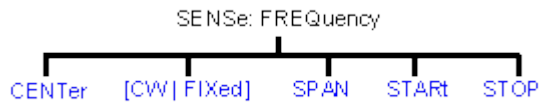

SENSE:FREQUENCY:

[CENTer](#)

[\[CW | FIXed\]](#)

[SPAN](#)

[START](#)

[STOP](#)

Click on a [Red](#) keyword to view the command details.

See Also

- [Example](#) using some of these commands.
- [Learn about Frequency Sweep](#)
- [Synchronizing the VNA and Controller](#)
- [SCPI Command Tree](#)

SENSe<cnum>:FREQUENCY:CENTer <num>

Applicable Models: E5080A, M9485A

(Read-Write) Sets the center frequency of the analyzer.

Parameters

<cnum> Any existing channel number. If unspecified, value is set to 1

<num> Center frequency. Choose any number between the **minimum** and **maximum** frequency limits of the analyzer. Units are Hz.

This command will accept **MIN** or **MAX** instead of a numeric parameter. See [SCPI Syntax](#) for more information.

Examples

```

SENS:FREQ:CENT 1000000
sense2:frequency:center 1mhz
sense2:frequency:center 1e6
  
```

Query Syntax SENSe<cnum>:FREQUENCY:CENTer?

Return Type Numeric

Default Center of the analyzer's frequency span

SENSe<cnum>:FREQUENCY[:CW | :FIXed] <num>

Applicable Models: E5080A, M9485A

(Read-Write) Sets the Continuous Wave (or Fixed) frequency for the power sweep for channels 1 to 36. Must also send [SENS:SWEEP:TYPE CW](#) to put the analyzer into CW sweep mode.

Parameters

<cnum> Any existing channel number. If unspecified, value is set to 1.

<num> CW frequency. Choose any number between the **minimum** and **maximum** frequency limits of the analyzer. Units are Hz.

This command will accept **MIN** or **MAX** instead of a numeric parameter. See [SCPI Syntax](#) for more information.

Examples

```
SENS:FREQ 1000000
SENS:FREQ:CW MIN
sense2:frequency:fixed 1mhz
```

Query Syntax SENSe<cnum>:FREQUENCY[:CW | :FIXed]?

Return Type Numeric

Default 1E5 Hz

SENSe<cnum>:FREQUENCY:SPAN <num>

Applicable Models: E5080A, M9485A

(Read-Write) Sets the frequency span of the analyzer.

Parameters

<cnum> Any existing channel number. If unspecified, value is set to 1

<num> Frequency span in Hz. Choose any number between **0** (minimum) and the **maximum** frequency span of the analyzer.

This command will accept **MIN** or **MAX** instead of a numeric parameter. See [SCPI Syntax](#) for more information.

Examples

```
SENS:FREQ:SPAN 1000000
sense2:frequency:span max
```

Query Syntax SENSe<cnum>:FREQUENCY:SPAN?

Return Type Numeric

Default Maximum frequency span of the analyzer

SENSe<cnum>:FREQUENCY:STARt <num>

Applicable Models: E5080A, M9485A

(Read-Write) Sets the start frequency of the analyzer.

Parameters

<cnum> Any existing channel number. If unspecified, value is set to 1

<num> Start frequency. Choose any number between the **MIN** and **MAX** frequency limits of the analyzer. Units are Hz
 If FREQ:START is set greater than FREQ:STOP, then STOP is set equal to START.
 This command will accept **MIN** or **MAX** instead of a numeric parameter. See [SCPI Syntax](#) for more information.

Examples

```
SENS:FREQ:STAR 1000000
sense2:frequency:start MIN
```

Query Syntax SENSe<cnum>:FREQUENCY:STARt?

If [Sweep type is segment](#), this query returns the start frequency of the first segment.

Return Type Numeric

Default Minimum frequency of the analyzer

SENSe<cnum>:FREQUENCY:STOP <num>

Applicable Models: E5080A, M9485A

(Read-Write) Sets the stop frequency of the analyzer.

Parameters

<cnum> Any existing channel number. If unspecified, value is set to 1

<num> Stop frequency. Choose any number between: the **minimum** and **maximum** frequency limits of the analyzer. Units are Hz.
 If FREQ:STOP is set less than FREQ:START, then START will be set equal to STOP.
 This command will accept **MIN** or **MAX** instead of a numeric parameter. See [SCPI Syntax](#) for more information.

Examples `SENS:FREQ:STOP 1000000`
`sense2:frequency:stop max`

Query Syntax `SENSe<cnum>:FREQuency:STOP?`
If [Sweep type is segment](#), this query returns the stop frequency of the last segment.

Return Type Numeric

Default Maximum frequency of the analyzer

Last Modified:

29-Sep-2015 First Release



Sense:Mixer Commands

Performs Mixer setup and configuration.

SENSe:MIXer:**APPLy****CALC****DISCard****IF:FREQuency**| **SIDeband**| **START**| **STOP****INPut:FREQuency**| **DENominator**| **FIXed**| **MODE**| **NUMerator**| **START**| **STOP****INPut:POWer**| **START**| **STOP**| **USENominal****LO:FREQuency**| **DENominator**| **FIXed**| **ILTI**| **MODE**| **NUMerator**| **START**| **STOP****LO:NAME | NAME****LO:POWer**| **START**| **STOP****LOAD****NORMalize:POINT****OUTPut:FREQuency**| **FIXed**| **MODE**| **SIDeband**| **START**| **STOP****PMAP**| **INPut?**| **OUTPut?****RECalculate****REVerse****ROLE**| **CATalog?**| **DEVice**

SAVE

SEGMENT More Commands

STAGE (number of LOs)

XAXIS

Click on a [Red](#) keyword to view the command details.

See Also

- Example Programs
- Learn about the Frequency Converter Application
- [Synchronizing the VNA and Controller](#)
- [SCPI Command Tree](#)

Note: If you are changing several mixer configuration settings, you can make all the changes first and then issue the [Calculate](#) and [Apply](#) commands as you would do from the user interface.

SENSe<ch>:MIXer:APPLy

Applicable Models: E5080A, M9485A

(Write only) Applies the mixer setup settings and turns the channel ON. (Performs the same function as the Apply button on the mixer setup dialog box).

Parameters

<ch> Any existing channel number. If unspecified, value is set to 1

Examples `SENS:MIX:APPL`

Query Syntax Not Applicable

Default Not Applicable

S

SENSe<ch>:MIXer:CALCulate <char>

Applicable Models: E5080A, M9485A

(Write only) Calculates the Input, IF, or Output frequencies of the mixer setup and updates the channel settings.

Parameters

<ch> Any existing channel number. If unspecified, value is set to 1

<char> Mixer port to be calculated. Choose from:

<char>	1st or only stage requires:	In addition, 2nd stage requires:

INPut	<ul style="list-style-type: none"> • Output Start/Stop/Fixed frequencies • LO Start/Stop/Fixed frequencies • Output sideband (High or Low) 	<ul style="list-style-type: none"> • IF Start/Stop/Fixed frequencies • 2nd Start/Stop/Fixed frequencies • IF sideband (High or Low)
BOTH	NA	<ul style="list-style-type: none"> • IF Start/Stop/Fixed frequencies • Both Start/Stop/Fixed frequencies
OUTPut	<ul style="list-style-type: none"> • Input Start/Stop/Fixed frequencies • LO Start/Stop/Fixed frequencies • Output sideband (High or Low) 	<ul style="list-style-type: none"> • IF Start/Stop/Fixed frequencies • 2nd Start/Stop/Fixed frequencies • IF sideband (High or Low)
LO_1	<ul style="list-style-type: none"> • Input Start/Stop/Fixed frequencies • Output Start/Stop/Fixed frequencies • Output sideband (High or Low) 	<ul style="list-style-type: none"> • IF Start/Stop/Fixed frequencies • 2nd Start/Stop/Fixed frequencies • IF sideband (High or Low)
LO_2	NA	<ul style="list-style-type: none"> • Input Start/Stop/Fixed frequencies • 1st LO Start/Stop/Fixed frequencies • Output Start/Stop/Fixed frequencies • IF sideband(High or Low) • Output sideband(High or Low)

Examples `SENS:MIX:CALC` Output

Query Syntax Not Applicable

Default Not Applicable

SENSe<ch>:MIXer:DISCard**Applicable Models:** E5080A, M9485A

(Write only) Cancels changes that have been made to the Converter setup and reverts to the previously-saved setup. Same as the Cancel button on the mixer setup dialog box.

Parameters

<ch> Any existing channel number. If unspecified, value is set to 1

Examples `SENS:MIX:DISC`

Query Syntax Not Applicable

Default Not Applicable

SENSe<ch>:MIXer:IF:FREQuency:SIDeband <char>**Applicable Models:** E5080A, M9485A

(Read-Write) When [two LO stages are used](#), sets or returns whether to select the sum or difference for the IF1 product. (Input + or - LO1 = IF1)



- This setting corresponds to the  buttons on LO1 on the Mixer setup dialog
- This setting is ignored when [ONE LO stage](#) is selected.
- Also set [SENS:MIX:OUTP:FREQ:SID](#) to LOW or HIGH to determine the output frequency of the mixer.

[See Note](#)

Parameters

<ch> Any existing channel number. If unspecified, value is set to 1.

<char> Sideband value. Choose from

LOW - Difference (-)

HIGH - Sum (+)

Examples `SENS:MIX:IF:FREQ:SID LOW`
`SENSe2:MIXer:IF:FREQ:SIDeband HIGH`

Query Syntax `SENSe<ch>:MIXer:IF:FREQuency:SIDeband?`

Return Type Character

Default LOW

SENSe<ch>:MIXer:IF:FREQuency:STARt <num>

Applicable Models: E5080A, M9485A

(Read-Write) Sets or returns the IF start frequency value of the mixer. [See Note](#)

Parameters

<ch> Any existing channel number. If unspecified, value is set to 1.

<num> IF Start Frequency value

Examples

```
SENS:MIX:IF:FREQ:STAR 1e9
SENSe2:MIXer:IF:FREQ:STARt 1000000000
```

Query Syntax SENSe<ch>:MIXer:IF:FREQuency:STARt?

Return Type Numeric

Default Not Applicable

SENSe<ch>:MIXer:IF:FREQuency:STOP <num>

Applicable Models: E5080A, M9485A

(Read-Write) Sets or returns the stop frequency value of the mixer IF frequency. [See Note](#)

Parameters

<ch> Any existing channel number. If unspecified, value is set to 1.

<num> IF Stop Frequency value

Examples

```
SENS:MIX:IF:FREQ:STOP 2e9
SENSe2:MIXer:IF:FREQ:STOP 2000000000
```

Query Syntax SENSe<ch>:MIXer:IF:FREQuency:STOP?

Return Type Numeric

Default Not Applicable

SENSe<ch>:MIXer:INPut:FREQuency:DENominator <value>

Applicable Models: E5080A, M9485A

(Read-Write) Sets or returns the denominator value of the Input Fractional Multiplier. [See Note](#)

Parameters

<ch> Any existing channel number. If unspecified, value is set to 1.

<value> Input denominator value.

Examples `SENS:MIX:INP:FREQ:DEN 5`
`SENS2:MIXer:INPut:FREQ:DENominator 4`

Query Syntax `SENSe<ch>:MIXer:INPut:FREQuency:DENominator?`

Return Type Numeric

Default Not Applicable

SENSe<ch>:MIXer:INPut:FREQuency:FIXed<value>

Applicable Models: E5080A, M9485A

(Read-Write) Sets or returns the fixed frequency of the input. [See Note](#)

Parameters

<ch> Any existing channel number. If unspecified, value is set to 1.

<value> Input frequency.

Examples `SENSe:MIXer:INPut:FREQ:FIXed 1e9`
`SENSe2:MIXer:INPut:FREQ:FIXed 1000000000`

Query Syntax `SENSe<ch>:MIXer:INPut:FREQuency:FIXed?`

Return Type Numeric

Default Not Applicable

SENSe<ch>:MIXer:INPut:FREQuency:MODE <char>

Applicable Models: E5080A, M9485A

(Read-Write) Sets or returns the Input sweep mode.

Parameters

<ch> Any existing channel number. If unspecified, value is set to 1.

<char> Input sweep mode. Choose either **FIXED** or **SWEPT**

Examples `SENS:MIX:INP:FREQ:MODE FIXED`
`SENSe2:MIXer:INP:FREQ:MODE swept`

Query Syntax SENSE<ch>:MIXer:INPut:FREQuency:MODE?

Return Type Character

Default Fixed

SENSE<ch>:MIXer:INPut:FREQuency:NUMerator <value>

Applicable Models: E5080A, M9485A

(Read-Write) Sets or returns the numerator value of the Input Fractional Multiplier. [See Note](#)

Parameters

<ch> Any existing channel number. If unspecified, value is set to 1.

<value> Input numerator value.

Examples

```
SENS:MIX:INP:FREQ:NUM 3
SENSe2:MIXer:INPut:FREQ:NUMerator 1
```

Query Syntax SENSE<ch>:MIXer:INPut:FREQ:NUMerator?

Return Type Numeric

Default Not Applicable

SENSE<ch>:MIXer:INPut:FREQuency:STARt <value>

Applicable Models: E5080A, M9485A

(Read-Write) Sets or returns the Input start frequency value of the mixer. [See Note](#)

Parameters

<ch> Any existing channel number. If unspecified, value is set to 1.

<value> Input Start frequency

Examples

```
SENS:MIX:INP:FREQ:STAR 1e9
SENSe2:MIXer:INPut:FREQ:STARt 1000000000
```

Query Syntax SENSE<ch>:MIXer:INPut:FREQuency:STARt?

Return Type Numeric

Default Not Applicable

SENSe<ch>:MIXer:INPut:FREQuency:STOP <value>**Applicable Models:** E5080A, M9485A**(Read-Write)** Sets or returns the Input stop frequency value of the mixer. [See Note](#)**Parameters**

<ch> Any existing channel number. If unspecified, value is set to 1.

<value> Input stop frequency

Examples

```
SENS:MIX:INP:FREQ:STOP 2e9
SENSe2:MIXer:INPut:FREQ:STOP 2000000000
```

Query Syntax SENSe<ch>:MIXer:INPut:FREQuency:STOP?**Return Type** Numeric**Default** Not Applicable**SENSe<ch>:MIXer:INPut:POWer <value>****Applicable Models:** E5080A, M9485A**(Read-Write)** Sets or returns the value of the Input Power.**Parameters**

<ch> Any existing channel number. If unspecified, value is set to 1.

<value> Input power in dBm.

Examples

```
SENS:MIX:INP:POW 9
SENSe2:MIXer:INPut:POWer 5
```

Query Syntax SENSe<ch>:MIXer:INPut:POWer?**Return Type** Numeric**Default** Not Applicable**SENSe<ch>:MIXer:INPut:POWer:STARt <value>****Applicable Models:** E5080A, M9485A**(Read-Write)** Sets the input start power for a power sweep in a mixer channel like SMC. The value is only

used when the sweep type is power sweep.

Parameters

<ch> Any existing channel number. If unspecified, value is set to 1.

<value> Input power value in units of dBm.

Examples

```
SENS:MIX:INP:POW STAR 6
SENSe2:MIXer:INPut:POWer:STARt 5
```

Query Syntax SENSE<ch>:MIXer:INPut:POWer:STARt?

Return Type Numeric

Default Not Applicable

SENSe<ch>:MIXer:INPut:POWer:STOP <value>

Applicable Models: E5080A, M9485A

(Read-Write) Sets the input stop power for a power sweep in a mixer channel . The value is only used when the sweep type is power sweep.

Parameters

<ch> Any existing channel number. If unspecified, value is set to 1.

<value> Input power value in units of dBm.

Examples

```
SENS:MIX:INP:POW STOP 9
SENSe2:MIXer:INPut:POWer:STOP 5
```

Query Syntax SENSE<ch>:MIXer:INPut:POWer:STOP?

Return Type Numeric

Default Not Applicable

SENSe<ch>:MIXer:INPut:POWer:USENominal <bool>

Applicable Models: E5080A, M9485A

(Read-Write) Toggles the Use Nominal Incident Power setting ON and OFF. This setting is ONLY to be used with SMC measurements. Learn more about Nominal Incident Power.

Parameters

<ch> Any existing channel number. If unspecified, value is set to 1.

<bool> Nominal Incident Power State. Choose from:
 ON (1) - Turn nominal incident power ON
 OFF (0) - Turn nominal incident power OFF

Examples `SENS:MIX:INP:POW:USEN 1`
`SENSe2:MIXer:INPut:POWer:USENominal OFF`

Query Syntax `SENSe<ch>:MIXer:INPut:POWer:USENominal?`

Return Type Boolean

Default OFF

SENSe<ch>:MIXer:LO<n>:FREQuency:DENominator <value>

Applicable Models: E5080A, M9485A

(Read-Write) Sets or returns the denominator value of the LO Fractional Multiplier. [See Note](#)

Parameters

<ch> Any existing channel number. If unspecified, value is set to 1.
 <n> LO stage number. Choose 1 or 2.
 <value> LO denominator.

Examples `SENS:MIX:LO:FREQ:DEN 5`
`SENSe2:MIXer:LO2:FREQ:DENominator 4`

Query Syntax `SENSe<ch>:MIXer:LO<n>:FREQuency:DENominator?`

Return Type Numeric

Default 1

SENSe<ch>:MIXer:LO<n>:FREQuency:FIXed <value>

Applicable Models: E5080A, M9485A

(Read-Write) Sets or returns the fixed frequency of the specified mixer LO. [See Note](#)

Parameters

<ch> Any existing channel number. If unspecified, value is set to 1.
 <n> LO stage number. Choose 1 or 2

<value> LO frequency.

Examples `SENS:MIX:LO:FREQ:FIX 1e9`
`SENSe2:MIXer:LO2:FREQ:FIXed 1000000000`

Query Syntax `SENSe<ch>:MIXer:LO<n>:FREQuency:FIXed?`

Return Type Numeric

Default Not Applicable

SENSe<ch>:MIXer:LO<n>:FREQuency:ILTI <bool>

Applicable Models: E5080A, M9485A

(Read-Write) Specifies whether to use the Input frequency that is **greater than** the LO or **less than** the LO. To learn more, see the mixer setup dialog box help.

Parameters

<ch> Any existing channel number. If unspecified, value is set to 1.

<n> LO stage number. Choose **1** or **2**

<bool> **ON (1)** - Use the Input that is Greater than the specified LO.
OFF (0) - Use the Input that is Less than the specified LO.

Examples `SENS:MIX:LO1:FREQ:ILTI 1`
`sense2:mixer:lo2:frequency:ilti ON`

Query Syntax `SENSe<ch>:MIXer:LO<n>:FREQuency:ILTI?`

Return Type Boolean

Default OFF

SENSe<ch>:MIXer:LO<n>:FREQuency:MODE <char>

Applicable Models: E5080A, M9485A

(Read-Write) Sets or returns the LO sweep mode.

Parameters

<ch> Any existing channel number. If unspecified, value is set to 1.

<n> LO stage number. Choose **1** or **2**

<char> LO sweep mode. Choose either **FIXED** or **SWEPT**

Examples `SENS:MIX:LO:FREQ:MODE FIXED`
`SENSe2:MIXer:LO2:FREQ:MODE swept`

Query Syntax `SENSe<ch>:MIXer:LO<n>:FREQuency:MODE?`

Return Type Character

Default Fixed

SENSe<ch>:MIXer:LO<n>:FREQuency:NUMerator <value>

Applicable Models: E5080A, M9485A

(Read-Write) Sets or returns the numerator value of the LO Fractional Multiplier. [See Note](#)

Parameters

<ch> Any existing channel number. If unspecified, value is set to 1.

<n> LO stage number. Choose **1** or **2**

<value> LO Numerator.

Examples `SENS:MIX:LO:FREQ:NUM 5`
`SENSe2:MIXer:LO2:FREQ:NUMerator 4`

Query Syntax `SENSe<ch>:MIXer:LO<n>:FREQuency:NUMerator?`

Return Type Numeric

Default Not Applicable

SENSe<ch>:MIXer:LO<n>:FREQuency:START <value>

Applicable Models: E5080A, M9485A

(Read-Write) Sets or returns the LO start frequency value. [See Note](#)

Parameters

<ch> Any existing channel number. If unspecified, value is set to 1.

<n> LO stage number. Choose **1** or **2**

<value> LO Start Frequency in Hertz.

Examples `SENS:MIX:LO:FREQ:STAR 5E9`

Query Syntax `SENSe<ch>:MIXer:LO<n>:FREQuency:STARt?`

Return Type Numeric

Default Not Applicable

SENSe<ch>:MIXer:LO<n>:FREQuency:STOP <value>

Applicable Models: E5080A, M9485A

(Read-Write) Sets or returns the LO stop frequency value. [See Note](#)

Parameters

<ch> Any existing channel number. If unspecified, value is set to 1.

<n> LO stage number. Choose 1 or 2

<value> LO Stop Frequency in Hertz.

Examples `SENS:MIX:LO:FREQ:STOP 5E9`

Query Syntax `SENSe<ch>:MIXer:LO<n>:FREQuency:STOP?`

Return Type Numeric

Default Not Applicable

SENSe<ch>:MIXer:LO<n>:NAME | NAME <value>

Applicable Models: E5080A, M9485A

(Read-Write) Sets or returns the name of the VNA internal source or external source to use as the LO in a converter measurement.

Important Note: This setting is immediately send to the channel configuration. First set and apply mixer frequency settings, then send this command. Otherwise, 'invalid setting' errors may occur.

See Remotely Specifying a Source Port.

Parameters

<ch> Any existing channel number. If unspecified, value is set to 1.

<n> LO stage number. Choose 1 or 2.

<value> **(string)** - LO Source name. Use [Source:CAT?](#) to return a list of valid source ports. An external source must be configured and selected to be valid. [Learn more about](#)

[external source configuration.](#)

Examples	<code>SENS:MIX:LO:NAME "MySource"</code>
Query Syntax	<code>SENSe<ch>:MIXer:LO<n>:NAME?</code>
Return Type	String
Default	"Not Controlled"

SENSe<ch>:MIXer:LO<n>:POWer <value>

Applicable Models: E5080A, M9485A

(Read-Write) Sets or returns the LO Power fixed value.

Parameters

<ch>	Any existing channel number. If unspecified, value is set to 1.
<n>	LO stage. Choose 1 or 2
<value>	LO Power in dBm

Examples	<code>SENS:MIX:LO:POW 9</code>
Query Syntax	<code>SENSe<ch>:MIXer:LO<n>:POWer?</code>
Return Type	Numeric
Default	Not Applicable

SENSe<ch>:MIXer:LO<n>:POWer:STARt <value>

Applicable Models: E5080A, M9485A

(Read-Write) For an LO power sweep, sets or returns the LO power start value.

Parameters

<ch>	Any existing channel number. If unspecified, value is set to 1.
<n>	LO stage. Choose 1
<value>	LO start power in dBm

Examples	<code>SENS:MIX:LO1:POW:STAR -10</code>
-----------------	--

Query Syntax SENSE<ch>:MIXer:LO1:POWer:START?

Return Type Numeric

Default - 20 dBm

SENSE<ch>:MIXer:LO<n>:POWer:STOP <value>

Applicable Models: E5080A, M9485A

(Read-Write) For an LO power sweep, sets or returns the LO power stop value.

Parameters

<ch> Any existing channel number. If unspecified, value is set to 1.

<n> LO stage. Choose 1

<value> LO stop power in dBm

Examples `SENS:MIX:LO1:POW:STOP 10`

Query Syntax SENSE<ch>:MIXer:LO1:POWer:STOP?

Return Type Numeric

Default -10 dBm

SENSE<ch>:MIXer:LOAD <name>

Applicable Models: E5080A, M9485A

(Write-only) Loads a previously-configured mixer attributes file (.mxr)

Parameters

<ch> Any existing channel number. If unspecified, value is set to 1.

<name> Path and file name (including .mxr extension) to load.

Examples `SENSE:MIXer:LOAD "C:/Program Files/Keysight/Network Analyzer/Documents/Mixer/MyMixer.mxr"`

Default Not Applicable

SENSE<ch>:MIXer:NORMALize:POINT <value>

Applicable Models: E5080A, M9485A

(Read-Write) Sets or returns the data point for normalizing the phase measurement. [Learn more.](#)

Parameters

- <ch> Channel number of the SMC measurement. If unspecified, value is set to 1.
- <value> Normalization data point. Choose a data point number between 1 and the max number of data points in the sweep that has the least amount of expected noise.

Examples `SENS:MIX:NORM:POIN 101`
`sense2:mixer:normalize:point 50`

Query Syntax `SENSe<ch>:MIXer:NORMalize:POINT?`

Return Type Numeric

Default Middle point in the sweep

SENSe<ch>:MIXer:OUTPut:FREQuency:FIXed <value>

Applicable Models: E5080A, M9485A

(Read-Write) Sets or returns the output fixed frequency of the mixer. [See Note](#)

Parameters

- <ch> Any existing channel number. If unspecified, value is set to 1.
- <value> Output fixed frequency in Hertz.

Examples `SENS:MIX:OUTP:FREQ:FIX 5e9`

Query Syntax `SENSe<ch>:MIXer:OUTPut:FREQuency:FIXed?`

Return Type Numeric

Default Not Applicable

SENSe<ch>:MIXer:OUTPut:FREQuency:MODE <char>

Applicable Models: E5080A, M9485A

(Read-Write) Sets or returns the Output sweep mode.

Parameters

<ch> Any existing channel number. If unspecified, value is set to 1.

<char> Output sweep mode. Choose either **FIXED** or **SWEPT**

Examples `SENS:MIX:OUT:FREQ:MODE FIXED`
`SENSe2:MIXer:OUTPut:FREQuency:MODE swept`

Query Syntax `SENSe<ch>:MIXer:OUTPut:FREQuency:MODE?`

Return Type Character

Default Fixed

SENSe<ch>:MIXer:OUTPut:FREQuency:SIDeband <value>

Applicable Models: E5080A, M9485A

(Read-Write) Specify whether to select the sum (High) or difference (Low) products.

When one LO is used: Input + or - LO1 = Output frequency

When two LOs are used: IF1 + or - LO2 = Output frequency

Use [SENS:MIX:IF:FREQ:SID](#) when two LOs are used to determine the IF1 frequency.

Use [Sens:Mixer:Stage](#) to set 1 or 2 LOs

[See Note](#)

Parameters

<ch> Any existing channel number. If unspecified, value is set to 1.

<value> Sideband value. Choose from

LOW - Low or Difference (-)

HIGH - High or Sum (+)

Examples `SENS:MIX:OUTP:FREQ:SID LOW`
`SENSe2:MIXer:OUTPut:FREQ:SIDeband HIGH`

Query Syntax `SENSe<ch>:MIXer:OUTPut:FREQuency:SIDeband?`

Return Type Character

Default LOW

SENSe<ch>:MIXer:OUTPut:FREQuency:STARt <value>

Applicable Models: E5080A, M9485A

(Read-Write) Sets or returns the Output start frequency of the mixer. [See Note](#)

Parameters

- <ch> Any existing channel number. If unspecified, value is set to 1.
- <value> Output start frequency

Examples `SENS:MIX:OUTP:FREQ:STAR 1e9`
`SENSe2:MIXer:OUTPut:FREQ:STARt 1000000000`

Query Syntax `SENSe<ch>:MIXer:OUTPut:FREQuency:STARt?`

Return Type Numeric

Default Not Applicable

SENSe<ch>:MIXer:OUTPut:FREQuency:STOP <value>

Applicable Models: E5080A, M9485A

(Read-Write) Sets or returns the Output stop frequency of the mixer. [See Note](#)

Parameters

- <ch> Any existing channel number. If unspecified, value is set to 1.
- <value> Output stop frequency

Examples `SENS:MIX:OUTP:FREQ:STOP 1e9`
`SENSe2:MIXer:OUTPut:FREQ:STOP 1000000000`

Query Syntax `SENSe<ch>:MIXer:OUTPut:FREQuency:STOP?`

Return Type Numeric

Default Not Applicable

SENSe<ch>:MIXer:PMAP <in>,<out>

Applicable Models: E5080A, M9485A

(Write-only) Sets the VNA to DUT port map for FCA measurements. Use `SENS:MIX:PMAP:INP?` and `SENS:MIX:PMAP:OUTP?` to read these values. Learn about selectable FCA DUT ports.

Changing the ports may limit your ability to use an internal second source. If a selected port is shared by one of the sources, then that source will not be available as an LO source. Learn more about Internal second sources.

Parameters

<ch> Any existing channel number. If unspecified, value is set to 1.

<in> VNA port to connect to the DUT input.

- For SMC, choose any unused VNA port.
- For VMC, set to 1.

<out> VNA port to connect to the DUT output. Choose any unused port for SMC and VMC.

Examples

```
SENS:MIX:PMAP 2,1
sense2:mixer:pmap 4,2
```

Query Syntax Not Applicable

Default 1,2



SENSe<ch>:MIXer:PMAP:INPut?

Applicable Models: E5080A, M9485A

(Read-only) Returns the VNA port that is mapped to the DUT input. Use [SENS:MIX:PMAP](#) to set this value.

Learn about selectable FCA DUT ports.

Parameters

<ch> Any existing channel number. If unspecified, value is set to 1.

Examples

```
SENS:MIX:PMAP:INP?
sense2:mixer:pmap:input?
```

Default 1



SENSe<ch>:MIXer:PMAP:OUTPut?

Applicable Models: E5080A, M9485A

(Read-only) Returns the VNA port that is mapped to the DUT output. Use [SENS:MIX:PMAP](#) to set this value.

Learn about selectable FCA DUT ports.

Parameters

<ch> Any existing channel number. If unspecified, value is set to 1.

Examples `SENS:MIX:PMAP:OUTP?`
`sense2:mixer:pmap:output?`

Default 2



SENSe<ch>:MIXer:RECalculate

Applicable Models: E5080A, M9485A

(Write only) Repeats the last calculation that was performed, including all ON (state) segments in segment table.

Parameters

<ch> Any existing channel number. If unspecified, value is set to 1

Examples `SENS:MIX:REC`

Query Syntax Not Applicable

Default Not Applicable

SENSe<ch>:MIXer:REVerse <bool>

Applicable Models: E5080A, M9485A

(Read-Write) Sets whether to include SC12 sweeps during measurements.

Parameters

<ch> Any existing channel number. If unspecified, value is set to 1.

<bool> (Boolean) Choose from:
ON (1) - Include the SC12 (reverse) sweep.
OFF (0) - Do NOT Include the SC12 (reverse) sweep.

Examples `SENS:MIX:REV 1`
`sense2:mixer:reverse ON`

Query Syntax `SENSe<ch>:MIXer:REVerse?`

Return Type Boolean

Default ON (1)



SENSe<ch>:MIXer:SAVE <name>

Applicable Models: E5080A, M9485A

(Write-only) Saves the settings for the mixer/converter test setup to a mixer attributes file.

Parameters

<ch> Any existing channel number. If unspecified, value is set to 1.

<name> Path and file name (including .mxrx extension) to save.

Examples `SENSe:MIXer:SAVE "C:/Program Files/Keysight/Network Analyzer/Documents/Mixer/MyMixer.mxrx"`

Default Not Applicable

SENSe<ch>:MIXer:STAGe <n>

Applicable Models: E5080A, M9485A

(Read-Write) Number of IF stages (LOs) used in the mixer. [See Note](#)

Parameters

<ch> Any existing channel number. If unspecified, value is set to 1.

<n> Number of stages. Choose either **1** or **2**

Examples `SENSe:MIX:STAG 2`
`SENSe:MIXer:STAGE 1`

Query Syntax `SENSe<ch>:MIXer:STAGe?`

Return Type Numeric

Default 1

SENSe<ch>:MIXer:XAXis <char>

Applicable Models: E5080A, M9485A

(Read-Write) Sets or returns the swept frequency range to display on the X-axis for the IMDx channel. For FCA and GCX measurements, use [CALC:MIXer:XAXis](#)

Parameters

<ch> Channel number of the IMDx Converter measurement. If unspecified, value is set to 1.

<char> Frequency range to display on the X-Axis. NOT case-sensitive. Choose from:

- **INPUT** - Input frequency range
- **LO_1** - LO frequency range
- **OUTPUT** - Output frequency range

If the specified frequency range is not swept, the default swept range is used.

Examples

```
SENSe:MIXer:XAXis INPUT
sense2:mixer:xaxis LO_1
```

Return Type Character

Default Search is made in the following order until a swept range is found:

1. OUTPUT
2. INPUT (If the OUTPUT is fixed)
3. Number of Points (If ALL ranges are fixed)

Last modified:

29-Sep-2015 First Release



Sense:Multiplexer Commands

Controls External Test Sets (N44xx, E5091A, "Z", and "H" series).

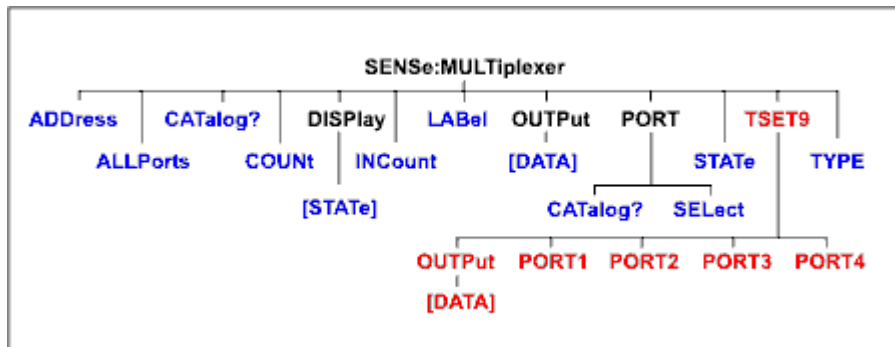
**SENSE:MULTiplexer:**[ADDRESS](#)[ALLPorts](#)[CATalog?](#)[COUNT?](#)[DISPlay](#)[INCount?](#)[LABel](#)**OUTPut**| [A|B|C|D|DATA|](#)

|

| [A|B|C|D:VOLTage|DATA|](#)| [|DATA|DATA|](#)**PORT**| [CATalog?](#)| [SElect](#)[STATE](#)**TSET9**| [OUTPut](#)| [PORT1](#)| [PORT2](#)| [PORT3](#)| [PORT4](#)[TYPE|TYPE](#)

Click on a **Red** keyword to view the command details.

See Also

- See an example program using these commands.
- Learn about External Test Set Control
- [Synchronizing the VNA and Controller](#)
- [SCPI Command Tree](#)

SENSe:MULTiplier<id>:ADDRess <address>**Applicable Models:** E5080A

(Read-Write) Sets and returns the address for the external test set at the specified ID. This command should be immediately preceded by the [SENS:MULT:TYPE](#) command.

Parameters

<id> Id of the external test set. If unspecified, Id is assumed to be 1. Must be previously set by the [SENS:MULT:TYPE](#) command.

<address> Integer The test set address.

- For a GPIB test set (N44xx and some specials), this is the GPIB address.
- For a test set I/O test set (some specials), it is the position of the test set in the chain (starting at 0).
- For USB test sets (E5091A), the address is set by DIP switches on the rear panel.

Examples

```
SENS:MULT1:TYPE "Z5623A_K66" ' use K66 test set, and reference
it through ID 1
SENS:MULT1:ADDR 0 ' first test set in sequence
' All subsequent commands using SENS:MULT1 will refer to this
test set
```

Query Syntax SENSe:MULTiplier<id>:ADDRess?

Return Type Numeric

Default Not Applicable

SENSe<cnum>:MULTiplier<id>:ALLPorts <string>**Applicable Models:** E5080A

(Read-Write) Sets or gets the port selections for all available ports on the specified channel.

Parameters

<cnum> Any existing channel number. If unspecified, value is set to 1.

<id> Id of the external test set. If unspecified, Id is assumed to be 1. Must be previously set by the [SENS:MULT:TYPE](#) command.

<string> Comma-separated list of port selections, one for each port. Each port selection must correspond to one of the values returned by [SENS:MULT:PORT:CAT?](#).
Do NOT include + and - .

Examples

```
' for channel 5 and test set 1, set port 1 to T1,
' port 2 to A, port 3 to R2+, port 4 to R3-.
SENS5:MULT1:ALLP "T1,A,R2,R3 "
```

Query Syntax SENSE<cnum>:MULTiplexer<id>:ALLPorts?

Return Type STRING

Default Not Applicable

SENSe:MULTiplexer:CATalog?

Applicable Models: E5080A

(Read-Only) Returns a comma-separated list of the external test sets models that are currently supported. Choose one of these items to send [SENS:MULT:TYPE](#).

Examples SENS:MULT:CAT?

Return Type String

Default Not Applicable

SENSe:MULTiplexer<id>:COUNT?

Applicable Models: E5080A

(Read-Only) Returns the total number of ports of the specified test set.
Returns 0 if no test set is connected (GPIB test sets only).

Parameters

<id> Id of the external test set. If unspecified, Id is assumed to be 1. Must be previously set by the [SENSe:MULT:TYPE](#) command.

Examples

```
SENS:MULT1:COUN?
sense:multiplexer2:count?
```

Return Type Numeric

Default Not Applicable

SENSe:MULTiplexer<id>:DISPlay[:STATE] <bool>

Applicable Models: E5080A

(Read-Write) Turns ON and OFF the display of the test set control status bar. This status bar indicates the test set that is being controlled and the current port mappings. This setting is turned ON automatically when the test set is enabled.

Parameters

<id> Id of the external test set. If unspecified, Id is assumed to be 1. Must be previously set by the [SENS:MULT:TYPE](#) command.

<bool> **ON or 1** - Turns ON the display.
OFF or 0 - Turns OFF the display.

Examples

```
SENS:MULT1:DISP 1
sense:multiplexer2:display:state on
```

Query Syntax SENSe:MULTiplexer<id>:DISPlay[:STATE]?

Return Type Boolean

Default OFF or 0

SENSe:MULTiplexer<id>:INCount?

Applicable Models: E5080A

(Read-Only) Returns the number of input ports for the specified test set.

- For test sets such as the E5091A that do NOT use jumper cables to route the stimulus and response signals, this command returns the number of test set ports that can be connected to the VNA.
- For test sets that DO use jumper cables to route the stimulus and response signals, such as the N44xx, the return value is not valid.

Parameters

<id> Id of the external test set. If unspecified, Id is assumed to be 1. Must be previously set by the [SENS:MULT:TYPE](#) command.

Examples

```
SENS3:MULT1:INC? ' returns the number of input ports for test set 1 on channel 3
```

Return Type Numeric

Default Not Applicable

SENSe<cnum>:MULTiplexer:LABel <string>

Applicable Models: E5080A

(Read-Write) Sets and returns the display label for the test set on the specified channel. The label appears in a status bar at the bottom of the VNA display when [SENS:MULT:DISP](#) is set to ON.

Parameters

<cnum> Any existing channel number. If unspecified, value is set to 1.

<string> Display label text.

Examples

```
SENS3:MULT:LAB 'High-power output'
```

Query Syntax SENSe<cnum>:MULTiplexer:LABel?

Return Type String

Default Not Applicable

SENSe<cnum>:MULTiplexer<id>:OUTPut:<grp>[:DATA] <num>

Applicable Models: E5080A

(Read-Write) Sets or returns the output port data for specified group with id of the E5092A multiport test set.

Parameters

<cnum> Any existing channel number. If unspecified, value is set to 1.

<id> Id of the external test set either 1 or 2. If unspecified, Id is assumed to be 1. Must be previously set by the [SENS:MULT:TYPE](#) command.

<grp> A | B | C | D

<num> An integer specifying the decimal value of the control line. Values are obtained by adding weights from the following table that correspond to individual lines.

The output port data range is between 0 to 255 (0=All line are turns OFF and 255 all lines are turn ON).

Line	Weight
1	1
2	2
3	4
4	8
5	16
6	32
7	64
8	128

Examples SENS3:MULT1:OUTP:B 8

Query Syntax SENSE<cnum>:MULTiplexer<id>:OUTPut:<grp>[:DATA]?

Return Type Numeric

Default 0

SENSe<cnum>:MULTiplexer<id>:OUTPut:<grp>:VOLTage[:DATA] <volt>

Applicable Models: E5080A

(Read-Write) Sets or returns the output voltage for specified group with id of the E5092A multiport test set.

Parameters

<cnum> Any existing channel number. If unspecified, value is set to 1.

<id> Id of the external test set either 1 or 2. If unspecified, Id is assumed to be 1. Must be previously set by the [SENS:MULT:TYPE](#) command.

<grp> A | B | C | D

<volt> Output voltage range for <grp> is between 0 to 5.2V and resolution is 10mV.

Examples `SENS3:MULT1:OUTP:B:VOLT 4.2`

Query Syntax `SENSe<num>:MULTiplexer<id>:OUTPut:<grp>:VOLtage[:DATA]`

Return Type Numeric

Default 0 V

`SENSe<num>:MULTiplexer<id>:OUTPut[:DATA | DATA] <num>`

Applicable Models: E5080A

(Read-Write) Sets or returns the status of HIGH/LOW of all the control lines of the E5091A whose ID is 1 to 2 (id) when measuring selected channel in the measurement using the E5091A.

Note: This command is available only for E5091A multiport test set.

Parameters

<num> Any existing channel number. If unspecified, value is set to 1.

<id> Id of the external test set. If unspecified, Id is assumed to be 1. Must be previously set by the [SENS:MULT:TYPE](#) command.

<num> An integer specifying the decimal value of the control line. Values are obtained by adding weights from the following table that correspond to individual lines.

Line	Weight
1	1
2	2
3	4
4	8
5	16
6	32
7	64
8	128

Note:

- The E5091A interprets SENS:MULT1:OUTP 0 as all lines OFF.
- All "Z" and "H" series test sets interpret SENS:MULT1:OUTP 0 as all lines ON.

Refer to your test set documentation for setting control line values.

Examples `SENS3:MULT1:OUTP 48 'For Z5623A K64, lines 5 and 6 are OFF; all other lines are set to ON state.`

Query Syntax `SENSe<cnm>:MULTiplexer<id>:OUTPut[:DATA]?`

Return Type Numeric

Default Not Applicable

SENSe<cnm>:MULTiplexer<id>:PORT<pnum>:CATalog?

Applicable Models: E5080A

(Read-Only) Returns a comma-separated list of valid port selections for the specified port.

Parameters

<cnm> Any existing channel number. If unspecified, value is set to 1.

<id> Id of the external test set. If unspecified, Id is assumed to be 1. Must be previously set by the [SENS:MULT:TYPE](#) command.

<pnum> Integer - Input port number for which to return valid Output port selections. Read the number of input ports for the test set using [SENS:MULT:INC?](#)

Examples `SENS:MULT1:PORT3:CAT? ' returns the valid port selections for port 3`

Return Type String

Default Not Applicable

SENSe<cnm>:MULTiplexer<id>:PORT<pnum>:SElect <string>

Applicable Models: E5080A

(Write-Only) Sets and returns a port mapping for a single port. If this command creates a conflict with an

existing port, the VNA will resolve the conflict.

Note: This command is not supported for the Z5623AK44.

Parameters

- <cnm> Channel number of the measurement. If unspecified, value is set to 1.
- <id> Id of the external test set. If unspecified, Id is assumed to be 1. Must be previously set by the [SENSe:MULT:TYPE](#) command.
- <pnum> Integer - Logical port number.
- <string> Physical port number.

Examples `SENS:MULT1:PORT3:SEL "4" 'sets logical port 3 to physical port 4.`

Return Type String

Default Not Applicable

SENSe:MULTiplexer<id>:STATE <bool>

Applicable Models: E5080A

(Read-Write) Enables and disables (ON/OFF) the port mapping and control line output of the specified test set.

If the specified test set is not connected or not ON, then setting State ON will report an error. All other properties can be set when the test set is not connected.

When this command is set to ON, then the display of the test set status bar ([SENS:MULT:DISP](#)) is also set to ON.

Parameters

- <id> Id of the external test set. If unspecified, Id is assumed to be 1. Must be previously set by the [SENS:MULT:TYPE](#) command.
- <bool> ON(1) Enables test set control.
OFF (0) Disables test set control.

Examples `SENS:MULT1:STAT 1
sense2:multiplexer2:state on`

Query Syntax `SENSe<cnm>:MULTiplexer<id>:STATE?`

Return Type Boolean

Default OFF (0)

SENSe:MULTiplexer<id>:TYPE | TYPE <name>

Applicable Models: E5080A

(Read-Write) Loads a configuration file for the specified type of external test set.

This command should be immediately followed by the [SENS:MULT:ADDR](#) command.

Parameters

<name> String The name of the type of test set. Must be one of the items in the list returned by the [SENS:MULT:CAT?](#) query.

<id> Id of the external test set. Set by this command. Use consecutive values starting at 1.

Examples `SENS:MULT1:TYPE "Z5623AK66" ' use K66 test set, and reference it through ID 1`

Query Syntax SENSe:MULTiplexer<id>:TYPE?

Return Type String

Default Not Applicable

Last Modified:

29-Sep-2015 First Release



Sense:Roscillator Command

[Learn about the Reference Osc.](#)

See the rear-panel 10 MHz connector.

SENSe:ROSCillator:SOURce?

Applicable Models: E5080A

(Read-only) Applying a 10 MHz signal to the Reference Oscillator connector automatically sets the Reference Oscillator to EXTernal. This command allows you to check that it worked.

- **EXT** is returned when a signal is present at the 10 MHz Reference Oscillator connector.
- **INT** is returned when NO signal is present at the 10 MHz Reference Oscillator connector.

Examples

```
SENS:ROSC:SOUR?  
sense:roscillator:source?
```

Return Type Character

Default Not applicable

Last Modified:

29-Sep-2015 First Release

E5080A

Sense:Segment Commands

Defines the segment sweep settings.

Enable segment sweep with [SENS:SWE:TYPE SEGM.](#)

SENSe:Segment:**ADD****ARBitrary****BANDwidth | BWIDth**| **[RESolution]**| **CONTRol**| **PORT**| **[RESolution]**| **CONTRol****COUNT****DELeTe**| **ALL****FREQuency**| **CENTer**| **SPAN**| **STARt**| **STOP****LIST****[STATe]**| **CONTRol****POWer**| **[LEVe]**| **CONTRol****SHLO**| **CONTRol****SWEep**| **DELay**| **CONTRol**| **DWELI**| **CONTRol**| **GENeration**| **CONTRol**| **POINTs**| **TIME**| **CONTRol**| **X**| **SPACing**

Click on a **Red** keyword to view the command details.

See Also

- Example: [Upload and Download a Segment List](#)
- [Learn about Segment Sweep](#)
- [Synchronizing the VNA and Controller](#)
- [SCPI Command Tree](#)

SENSe<cnum>:SEGMENT<snum>:ADD

Applicable Models: E5080A, M9485A

(Write-only) Adds a segment.

Parameters

- <cnum> Any existing channel number. If unspecified, value is set to 1
- <snum> Segment number to add. If unspecified, value is set to 1. Segment numbers must be sequential. If a new number is added where one currently exists, the existing segment and those following are incremented by one.

Examples Two Segments exist (1 and 2). The following command will add a new segment (1). The existing (1 and 2) will become (2 and 3) respectively.

```
SENS:SEGM1:ADD
sense2:segment1:add
```

Query Syntax Not applicable. Use Sense:Segment:Count to determine the number of segments in a trace.

Default Not Applicable

SENSe<cnum>:SEGMENT<snum>:ARBITRARY <bool>

Applicable Models: E5080A, M9485A

(Read-Write) Enables you to setup a segment sweep with arbitrary frequencies. The start and stop frequencies of each segment can overlap other segments. Also, each segment can have a start frequency that is greater than its stop frequency which causes a reverse sweep over that segment. Learn more about [Arbitrary Segment Sweep](#).

Parameters

- <cnum> Any existing channel number. If unspecified, value is set to 1.
- <snum> Any existing segment number.
- <bool> **ON or 1** - Allows the setup of arbitrary segment sweep.
OFF or 0 - Prevents the setup of arbitrary segment sweep.

Examples `SENS:SEGM:ARB ON`
`sense2:segment:arbitrary off`

Query Syntax `SENSe<cnum>:SEGMENT:ARbitrary?`

Return Type Boolean

Default OFF or 0

SENSe<cnum>:SEGMENT<snum>:BANDwidth | BWIDth[:RESolution] <num>

Applicable Models: E5080A, M9485A

(Read-Write) Sets the IF Bandwidth for the specified segment. First set [SENS:SEGM:BANDwidth | BWIDth:CONTRol](#) ON. All subsequent segments that are added assume the new IF Bandwidth value.

Parameters

<cnum> Any existing channel number. If unspecified, value is set to 1

<snum> Segment number to modify. Choose any existing segment number.

<num> IF Bandwidth in Hz. The list of valid IF Bandwidths is different depending on the VNA model. [\(Click to see the lists.\)](#) If an invalid number is specified, the analyzer will round up to the closest valid number.

Note: This command will accept **MIN** or **MAX** instead of a numeric parameter. See [SCPI Syntax](#) for more information.

Examples `SENS:SEGM:BWID 1KHZ`
`sense2:segment2:bwidth:resolution max`

Query Syntax `SENSe<cnum>:SEGMENT<snum>:BWIDth[:RESolution]?`

Return Type Numeric

Default Varies with VNA model.

SENSe<cnum>:SEGMENT<snum>:BANDwidth | BWIDth[:RESolution]:CONTRol <bool>

Applicable Models: E5080A, M9485A

(Read-Write) Specifies whether the IF Bandwidth resolution can be set independently for each segment.

Parameters

<cnum> Any existing channel number. If unspecified, value is set to 1

<snum> Segment number to modify. Choose any existing segment number.

<bool> **ON or 1** - Turns Bandwidth control ON. Bandwidth can be independently set for

each segment.

OFF or 0 - Turns Bandwidth control OFF. Use the channel IF bandwidth setting [SENS:BWID](#).

Examples

```
SENS:SEGM:BWID:CONT ON
sense2:segment2:bandwidth:control off
```

Query Syntax SENSE<cnum>:SEGMENT<snum>:BWIDth | BANDwidth[:RESolution]:CONTROL?

Return Type Boolean

Default OFF or 0

SENSe<cnum>:SEGMENT<snum>:BANDwidth | BWIDth:PORT<pnum>[:RESolution] <num>

Applicable Models: E5080A, M9485A

(Read-Write) Specifies whether the IF Bandwidth resolution can be set independently for each segment for the selected port and channel.

Parameters

- <cnum> Any existing channel number. If unspecified, value is set to 1
- <snum> Segment number to modify. Choose any existing segment number.
- <pnum> Individual port number of the source: Port 1 to Port 2/Port 4. If unspecified, value is set to 1.
- <num> IF Bandwidth of each segment in Hz. The list of valid IF Bandwidths is different depending on the VNA model. [\(Click to see the lists.\)](#) If an invalid number is specified, the analyzer will round up to the closest valid number.

Note: This command will accept **MIN** or **MAX** instead of a numeric parameter. See [SCPI Syntax](#) for more information.

Examples

```
SENS:SEGM:BWID:PORT1 1KHZ
sense2:segment2:bandwidth:PORT2:resolution max
```

Query Syntax SENSE<cnum>:SEGMENT<snum>:BWIDth \ BANDwidth:PORT<pnum>[:RESolution]?

Return Type Numeric

Default Varies with VNA model.

SENSe<cnum>:SEGMENT<snum>:BANDwidth | BWIDth:PORT<pnum>[:RESolution]:CONTROL <bool>

Applicable Models: E5080A, M9485A

(Read-Write) Turns ON or OFF the individual (Port 1 to Port 2/Port 4) IF Bandwidth control in the segment sweep table.

Parameters

- <cnm> Any existing channel number. If unspecified, value is set to 1
- <snum> Segment number to modify. Choose any existing segment number.
- <pnum> Individual port number of the source: Port 1 to Port 2/Port 4. If unspecified, value is set to 1.
- <bool> Specified the individual IFBW control, either ON or OFF.
ON or 1 - Turns ON the individual port IFBW control.
OFF or 0 - Turns OFF the individual port IFBW control.

Examples

```
SENS:SEGM:BWID:PORT1:CONT ON
sense2:segment2:bandwidth:PORT2:resolution:control off
```

Query Syntax SENSE<cnm>:SEGMENT<snum>:BWIDth |
BANDwidth:PORT<pnum>[:RESolution]:CONTROL?

Return Type Boolean

Default OFF or 0

SENSe<cnm>:SEGMENT<snum>:COUNT?

Applicable Models: E5080A, M9485A

(Read-only) Queries the number of segments that exist in the specified channel.

Parameters

- <cnm> Any existing channel number. If unspecified, value is set to 1
- <snum> Any existing segment number.

Examples

```
SENS:SEGM:COUNT?
sense2:segment:count?
```

Return Type Numeric

Default 1 segment

SENSe<cnm>:SEGMENT<snum>:DELEte

Applicable Models: E5080A, M9485A

(Write-only) Deletes the specified sweep segment. When ALL segments are deleted, [SENS:SWE:TYPE](#) is automatically set to Linear because there are no segments to sweep.

<cnm> Any existing channel number. If unspecified, value is set to 1.

<snum> Number of the segment to delete. If unspecified, value is set to 1.

Examples `SENS:SEGM:DEL`
`sense2:segment2:delete`

Query Syntax Not Applicable

Default Not applicable

SENSe<cnm>:SEGMENT<snum>:DELeTE:ALL

Applicable Models: E5080A, M9485A

(Write-only) Deletes all sweep segments. When this command is executed, [SENS:SWE:TYPE](#) is automatically set to Linear because there are no segments to sweep.

Parameters

<cnm> Any existing channel number. If unspecified, value is set to 1

<snum> Any existing segment number.

Examples `SENS:SEGM:DEL:ALL`
`sense2:segment:delete:all`

Query Syntax Not Applicable

Default Not Applicable

SENSe<cnm>:SEGMENT<snum>:FREQUency:CENTer <num>

Applicable Models: E5080A, M9485A

(Read-Write) Sets the Center Frequency for the specified segment. The Frequency Span of the segment remains the same. The Start and Stop Frequencies change accordingly.

Note: All previous segment's Start and Stop Frequencies that are larger than the new Start Frequency are changed to the new Start Frequency. All following segment's start and stop frequencies that are smaller than the new Stop Frequency are changed to the new Stop Frequency.

Parameters

<cnm> Any existing channel number. If unspecified, value is set to 1

<snum> Segment number to modify. Choose any existing segment number.

<num> Center Frequency in Hz. Choose any number between the **minimum** and **maximum** frequency of the analyzer.

Note: This command will accept **MIN** or **MAX** instead of a numeric parameter. See [SCPI Syntax](#) for more information.

Examples `SENS:SEGM:FREQ:CENT 1MHZ`
`sense2:segment2:frequency:center 1e9`

Query Syntax `SENSe<cnum>:SEGMENT<snum>:FREQUENCY:CENTer?`

Return Type Numeric

Default Stop Frequency of the previous segment. If first segment, start frequency of the analyzer.

SENSe<cnum>:SEGMENT<snum>:FREQUENCY:SPAN <num>

Applicable Models: E5080A, M9485A

(Read-Write) Sets the Frequency Span for the specified segment. The center frequency of the segment remains the same. The start and stop frequencies change accordingly.

Note: All previous segment's Start and Stop Frequencies that are larger than the new Start Frequency are changed to the new Start Frequency. All following segment's start and stop frequencies that are smaller than the new Stop Frequency are changed to the new Stop Frequency.

Parameters

<cnum> Any existing channel number. If unspecified, value is set to 1

<snum> Segment number to modify. Choose any existing segment number.

<num> Frequency Span in Hz. Choose any number between the **minimum** and **maximum** frequency of the analyzer.

Note: This command will accept **MIN** or **MAX** instead of a numeric parameter. See [SCPI Syntax](#) for more information.

Examples `SENS:SEGM:FREQ:SPAN 1MHZ`
`sense2:segment2:frequency:span max`

Query Syntax `SENSe<cnum>:SEGMENT<snum>:FREQUENCY:SPAN?`

Return Type Numeric

Default If first segment, frequency span of the analyzer. Otherwise 0.

SENSe<cnum>:SEGMENT<snum>:FREQUENCY:START <num>

Applicable Models: E5080A, M9485A

(Read-Write) Sets the Start Frequency for the specified sweep segment.

Notes:

All other segment Start and Stop Frequency values that are larger than this frequency are changed to this frequency.

To return the start and stop frequency of the entire sweep (all segments), Use [SENS:FREQ:START?](#) and [SENS:FREQ:STOP?](#)

Parameters

- <cnm> Any existing channel number. If unspecified, value is set to 1
- <snm> Segment number to modify. Choose any existing segment number.
- <num> Start Frequency in Hz. Choose any number between the **minimum** and **maximum** frequency of the analyzer.

Note: This command will accept **MIN** or **MAX** instead of a numeric parameter. See [SCPI Syntax](#) for more information.

Examples

```
SENS:SEGM:FREQ:STAR 1MHZ
sense2:segment2:frequency:start minimum
```

Query Syntax SENSE<cnm>:SEGMENT<snm>:FREQUENCY:START?

Return Type Numeric

Default Stop Frequency of the previous segment. If first segment, start frequency of the analyzer.

SENSE<cnm>:SEGMENT<snm>:FREQUENCY:STOP <num>

Applicable Models: E5080A, M9485A

(Read-Write) Sets the Stop Frequency for the specified sweep segment.

Notes:

All other segment Start and Stop Frequency values that are larger than this frequency are changed to this frequency.

To return the start and stop frequency of the entire sweep (all segments), Use [SENS:FREQ:START?](#) and [SENS:FREQ:STOP?](#)

Parameters

- <cnm> Any existing channel number. If unspecified, value is set to 1
- <snm> Segment number to modify. Choose any existing segment number.
- <num> Stop Frequency in Hz. Choose any number between the **minimum** and **maximum** frequency of the analyzer.

Note: This command will accept **MIN** or **MAX** instead of a numeric parameter. See

[SCPI Syntax](#) for more information.

Examples `SENS:SEGM:FREQ:STOP 1MHZ`
`sense2:segment2:frequency:stop maximum`

Query Syntax `SENSe<cnm>:SEGMENT<snum>:FREQUENCY:STOP?`

Return Type Numeric

Default If first segment, stop frequency of the analyzer. Otherwise, start frequency of the segment.

`SENSe<cnm>:SEGMENT<snum>:LIST <char>,<numSegs>,<data>`

Applicable Models: E5080A, M9485A

(Read-Write) Reads or writes the entire list of values in the segment sweep table.

Note: For binary data transfer, specify 64-bit instead of 32-bit using [FORMat\[:DATA\]](#). This is because higher frequencies used on VNA exceed the maximum value that can be represented by a 32-bit floating point number.

When sending/receiving this data as binary (FORMat[:DATA] REAL,64), use [FORMat:BORDER](#) to specify the correct 'endianness' (byte ordering) corresponding to your programming environment / computer platform.

Parameters

- <cnm> Any existing channel number. If unspecified, value is set to 1
- <snum> Any existing segment number.
- <char> Choose from:
 - SSTOP** - Frequency values are Start and Stop for each segment.
 - CSPAN** - Frequency values are Center and Span for each segment.
- <numSegs> Total number of sweep segments being input. This allows the VNA to determine how many values per-each-segment are in the input <data> block.
- <data> A 2-dimensional array of Segment data as a single data block. The data elements within a segment are each represented as real floating-point numbers as follows, and the data block is formed by interleaving all the segments together consecutively:
 1. Segment state (Boolean 1 for ON and 0 for OFF)
 2. Number of Points in the segment
 3. Start Freq (when <char> is SSTOP), or Center Freq (when <char> is CSPAN)
 4. Stop Freq (when <char> is SSTOP), or Freq Span (when <char> is CSPAN)
 5. IFBW (optional for the Write)
 6. Dwell Time (optional for the Write)

7. Power (optional for the Write) - see below.

The first four data elements must always be supplied. After those values, data must be supplied for successive optional elements. For example, to set dwell time values, you must also supply IFBW values, because IFBW (#5) precedes dwell time (#6) in the array order.

The [IF Bandwidth](#), [Sweep Time](#) and [Source Power](#) Control settings do NOT affect the order in which elements are interpreted.

The number of elements to supply for Power depends on the following two settings:

1. [Source Power Option](#) - ON allows segments to have independent power levels.
2. [Couple Ports](#) = Off allows different power levels for each test port.

CouplePorts	SourcePowerOption	Number of Elements
False	False	Each port has its own channel-wide power setting, which is set using SOURce:POWer[:LEVel] . Provide exactly 7 elements per segment. The last element (power) is ignored.
False	True	Provide 6 elements + total number of ports. The first 7 elements are still interpreted the same. The remaining elements (in-order) are interpreted as the power levels to set on that segment for Ports 2 through N, where N is the total number of ports currently enabled for the VNA or for a VNA with multiport external test set.
True	False	Provide exactly 7 elements per segment. The last element (power) is ignored.
True	True	Provide exactly 7 elements per segment. The last element (power) is honored.

Examples

```
SENS:SEGM:LIST SSTOP,1,1,201,10E6,26.5E9,1E3,0,-10 1 segment,
state ON, 201 points, 10 MHz to 26.5 GHz, 1kHz IFBW, 0 dwell
time, -10 dBm (port powers coupled)
```

```
sense2:segment:list? cspan
```

See [Upload and Download a Segment List](#) example program

Query Syntax

SENSe<cnum>:SEGMENT:LIST? [char].

If unspecified, char is set to SSTOP.

The number of data elements per segment returned will be 6 + total number of source ports, regardless of the [IF Bandwidth](#), [Sweep Time](#) and [Source Power](#) Control settings. For the N5264A, which has no source ports, the query will return just 6 values per segment. For all other VNA models, the last elements in each

segment correspond to the power level for each port.

Return Type Returns block data in the format specified by [FORMat\[:DATA\]](#).

Default Not Applicable

SENSe<cnum>:SEGMENT<snum>[:STATe] <bool>

Applicable Models: E5080A, M9485A

(Read-Write) Turns ON or OFF the specified sweep segment . At least ONE segment must be ON or [Sweep Mode](#) is automatically set to **Linear**.

Parameters

<cnum> Any existing channel number. If unspecified, value is set to 1

<snum> Segment number to be turned ON or OFF.

<bool> **ON or 1** - Turns segment ON.
OFF or 0 - Turns segment OFF.

Examples

```
SENS:SEGM ON
sense2:segment2:state off
```

Query Syntax SENSE<cnum>:SEGMENT<snum>[:STATe]?

Return Type Boolean

Default OFF or 0

SENSe<cnum>:SEGMENT<snum>:STATe:CONTROL <bool>

Applicable Models: M9485A

(Read-Write) Turns ON or OFF the specified/individual segment state control in the segment sweep table. At least ONE segment must be ON or is automatically set to **Linear**.

Parameters

<cnum> Any existing channel number. If unspecified, value is set to 1

<snum> Segment number to be turned ON or OFF.

<bool> **ON or 1** - Turns ON the individual segment state control. **OFF or 0** - Turns OFF the individual segment state control.

Examples

```
SENS:SEGM:STAT:CONT ON
sense2:segment2:state:control off
```

Query Syntax SENSE<cnum>:SEGMENT<snum>:STATe:CONTROL?

Return Type Boolean

Default OFF or 0

SENSe<cnum>:SEGMENT<snum>:POWer[<port>][:LEVel] <num>

Applicable Models: E5080A, M9485A

(Read-Write) Sets the Port Power level for the specified sweep segment. First set SENS:SEGM:POW:CONTRol ON.

When [port power is Coupled](#), setting port power for one port will apply port power for all source ports. All subsequent segments that are added assume the new Power Level value.

Parameters

<cnum> Any existing channel number. If unspecified, value is set to 1

<snum> Segment number to modify. Choose any existing segment number.

<port> Port number of the source. If unspecified, value is set to 1.

<num> Power level.

Note: The range of settable power values depends on the VNA model and if source attenuators are installed. To determine the range of values, send SOUR:POW? MAX and SOUR:POW? MIN. ([SOUR:POW:ATT:AUTO](#) must be set to ON).

Actual achievable leveled power depends on frequency.

Examples

```
SENS:SEGM:POW 0
sense2:segment2:power1:level -10
```

Query Syntax SENSe<cnum>:SEGMENT<snum>:POWer[<port>][:LEVel]?

Return Type Numeric

Default 0

SENSe<cnum>:SEGMENT<snum>:POWer[:LEVel]:CONTRol <bool>

Applicable Models: E5080A, M9485A

(Read-Write) Specifies whether Power Level can be set independently for each segment.

Parameters

<cnum> Any existing channel number. If unspecified, value is set to 1

<snum> Any existing segment number.

<bool> **ON or 1** - Turns Power Level control ON. Power level can be set for each segment.
OFF or 0 - Turns Power Level control OFF. Use the channel power level setting.

Examples `SENS:SEGM:POW:CONT ON`
`sense2:segment:power:level:control off`

Query Syntax `SENSe<cnum>:SEGMENT:POWER[:LEVEL]:CONTROL?`

Return Type Boolean

Default OFF or 0

SENSe<cnum>:SEGMENT<snum>:SHLO

Applicable Models: E5080A

(Read-Write) Sets or returns the Shift LO state of each segment in the segment sweep table for the selected channel.

Notes: The [SENS:SEGM:SHLO:CONT](#) command must first be set to ON before using this command.

Parameters

<cnum> Any existing channel number. If unspecified, value is set to 1

<snum> Any existing segment number.

Examples `SENS:SEGM:SHLO`
`sense2:segment2:shlo`

Query Syntax `SENSe<cnum>:SEGMENT<snum>:SHLO?`

Return Type Numeric

Default Not Applicable

SENSe<cnum>:SEGMENT<snum>:SHLO:CONTROL <bool>

Applicable Models: E5080A

(Read-Write) Turns ON or OFF the individual Shift LO state control in the segment sweep table.

Parameters

<cnum> Any existing channel number. If unspecified, value is set to 1

<snum> Any existing segment number.

<bool> **ON or 1** - Turns ON the individual Shift LO state control.
OFF or 0 - Turns OFF the individual Shift LO state control.

Examples `SENS:SEGM:SHLO:CONT ON`
`sense2:segment2:shlo:control off`

Query Syntax `SENSe<cnum>:SEGMENT<snum>:SHLO:CONTROL?`

Return Type Boolean

Default OFF or 0

SENSe<cnum>:SEGMENT<snum>:SWEep:DElay <num>

Applicable Models: E5080A, M9485A

(Read-Write) Sets or returns the sweep delay time of selected channel.

Notes: The [SENS:SEGM:SWE:DEL:CONT](#) command must first be set to ON before using this command.

Parameters

<cnum> Any existing channel number. If unspecified, value is set to 1

<snum> Any existing segment number.

<num> Range of sweep delay time is between 0 to 1 and the resolution is 0.001.

Notes: If the specified variable is out of the allowable setup range, the minimum value (if the lower limit of the range is not reached) or the maximum value (if the upper limit of the range is exceeded) is set.

<unit> s (second)

Examples `SENS:SEGM:SWE:DEL`
`sense2:segment2:sweep:delay`

Query Syntax `SENSe<cnum>:SEGMENT<snum>:SWEep:DElay?`

Return Type Numeric / Double precision floating point

Default 0

SENSe<cnum>:SEGMENT<snum>:SWEep:DElay:CONTRol <bool>

Applicable Models: E5080A, M9485A

(Read-Write) Turns ON or OFF the sweep delay time of selected channel.

Parameters

<cnum> Any existing channel number. If unspecified, value is set to 1

<snum> Any existing segment number.

<bool> **ON or 1** - Turns ON sweep delay time.
OFF or 0 - Turns OFF sweep delay time.

Examples `SENS:SEGM:SWE:DEL:CONT ON`
`sense2:segment2:sweep:delay:control off`

Query Syntax `SENSe<cnum>:SEGMENT<snum>:SWEep:DELay:CONTRol?`

Return Type Boolean

Default OFF or 0

SENSe<cnum>:SEGMENT<snum>:SWEep:DWELI <num>

Applicable Models: M9485A

(Read-Write) Sets or returns the sweep dwell time of selected channel.

Notes: The [SENS:SEGM:SWE:DWELI:CONT](#) command must first be set to ON before using this command.

Parameters

<cnum> Any existing channel number. If unspecified, value is set to 1

<snum> Any existing segment number.

<num> Range of sweep dwell time

Notes: If the specified variable is out of the allowable setup range, the minimum value (if the lower limit of the range is not reached) or the maximum value (if the upper limit of the range is exceeded) is set.

<unit> s (second)

Examples `SENS:SEGM:SWE:DWEL`
`sense2:segment2:sweep:dwell`

Query Syntax `SENSe<cnum>:SEGMENT<snum>:SWEep:DWELI?`

Return Type Numeric / Double precision floating point

Default 0

SENSe<cnum>:SEGMENT<snum>:SWEep:DWELI:CONTRol <bool>

Applicable Models: M9485A

(Read-Write) Turns ON or OFF the sweep dwell time of selected channel.

Parameters

- <cnm> Any existing channel number. If unspecified, value is set to 1
- <snm> Any existing segment number.
- <bool> **ON or 1** - Turns ON sweep dwell time.
OFF or 0 - Turns OFF sweep dwell time.

Examples `SENS:SEGM:SWE:DWEL:CONT ON`
`sense2:segment2:sweep:dwell:control off`

Query Syntax `SENSe<cnm>:SEGMent<snm>:SWEep:DWELI:CONTrol?`

Return Type Boolean

Default OFF or 0

SENSe<cnm>:SEGMent<snm>:SWEep:GENeration <char>

Applicable Models: E5080A

(Read-Write) Sets or returns the sweep mode of selected channel.

Notes: The [SENS:SEGM:SWE:GEN:CONT](#) command must first be set to ON before using this command.

Parameters

- <cnm> Any existing channel number. If unspecified, value is set to 1.
- <snm> Any existing segment number.
- <char> Select sweep mode from either of the following:
- "AUTO": Sets the sweep mode to the swept mode.
 - "STEPped": Sets the sweep mode to the stepped mode.

Examples `SENS:SEGM:SWE:GEN AUTO`
`sense2:segment2:sweep:generation stepped`

Query Syntax `SENSe<cnm>:SEGMent<snm>:SWEep:GENeration?`

Return Type Character

Default "AUTO"

SENSe<cnm>:SEGMent<snm>:SWEep:GENeration:CONTrol <bool>

Applicable Models: E5080A

(Read-Write) Turns ON or OFF the sweep mode of selected channel.

Parameters

- <cnum> Any existing channel number. If unspecified, value is set to 1.
- <snum> Any existing segment number.
- <bool> **ON or 1** - Turn ON sweep mode.
OFF or 0 - Turn OFF sweep mode.

Examples

```
SENS:SEGM:SWE:GEN:CONT ON
sense2:segment2:sweep:generation:control off
```

Query Syntax SENSE<cnum>:SEGMENT<snum>:SWEep:GENeration:CONTRol?

Return Type Boolean

Default OFF or 0

SENSe<cnum>:SEGMENT<snum>:SWEep:POINts <num>

Applicable Models: E5080A, M9485A

(Read-Write) Sets the number of data points for the specified sweep segment.

Parameters

- <cnum> Any existing channel number. If unspecified, value is set to 1.
- <snum> Any existing segment number. If unspecified, value is set to 1.
- <num> Number of measurement points in the segment. The total number of points in all segments cannot exceed **20001**. A segment can have as few as 2 point.

Note: This command will accept **MIN** or **MAX** instead of a numeric parameter. See [SCPI Syntax](#) for more information.

Examples

```
SENS:SEGM:SWE:POIN 51
sense2:segment2:sweep:points maximum
```

Query Syntax SENSE<cnum>:SEGMENT<snum>:SWEep:POINts?

Return Type Numeric

Default 201

SENSe<cnum>:SEGMENT<snum>:SWEep:TIME <num>

Applicable Models: E5080A, M9485A

(Read-Write) Sets the total time (including sweep delay time) the analyzer takes to sweep the specified sweep segment, for the segment sweep table of the selected channel.

Parameters

- <cnum> Any existing channel number. If unspecified, value is set to 1.
- <snum> Any existing segment number.
- <num> Sweep time in s (seconds). Choose a number between **0** and **100**.

Note: This command will accept **MIN** or **MAX** instead of a numeric parameter. See [SCPI Syntax](#) for more information.

Examples

```
SENS:SEGM:SWE:TIME 1ms
sense2:segment2:sweep:time .001
```

Query Syntax SENSE<cnum>:SEGMent<snum>:SWEep:TIME?

Return Type Numeric / Double precision floating point

Default Not Applicable

SENSE<cnum>:SEGMent<snum>:SWEep:TIME:CONTRol <bool>

Applicable Models: E5080A, M9485A

(Read-Write) Specifies whether Sweep Time can be set independently for each sweep segment.

Parameters

- <cnum> Any existing channel number. If unspecified, value is set to 1
- <snum> Any existing segment number.
- <bool> **ON or 1** - Turns Sweep Time control ON. Sweep Time can be set for each segment.
OFF or 0 - Turns Sweep Time control OFF. Uses the channel Sweep Time setting.

Examples

```
SENS:SEGM:SWE:TIME:CONT ON
sense2:segment:sweep:time:control off
```

Query Syntax SENSE<cnum>:SEGMent<snum>:SWEep:TIME:CONTRol?

Return Type Boolean

Default OFF or 0

SENSE<cnum>:SEGMent<snum>:X:SPACing <char>

Applicable Models: E5080A, M9485A

(Read-Write) Sets X-axis spacing ON or OFF.

Parameters

<cnum> Any existing channel number. If unspecified, value is set to 1

<snum> Any existing segment number.

<char> **LINear** - turns X-axis point spacing OFF.

OBASe - turns X-axis point spacing ON.

Examples

```
SENS:SEGM:X:SPACing LIN  
sense2:segment:spacing obase
```

Query Syntax SENSE<cnum>:SEGMENT<snum>:X:SPACing?

Return Type Character

Default LINear

Last Modified:

29-Sep-2015 First Release



Sense:Sweep Commands

Specifies the sweep functions of the analyzer.

SENSE:SWEep:**DWELI**| **AUTO**| **SDELay****GRoUps**| **COUnT****MODE****POINts****SLOCal**| **MAXimum**| **STATe****SPEed****STEP****TIME**| **AUTO****TRIGger**| **DELAY**| **MODE****TYPE**

Click on a **Red** keyword to view the command details.

See Also

- Example Programs
 - [Example of Triggering the VNA using SCPI](#)
 - [Learn about sweeping](#)
 - [Synchronizing the VNA and Controller](#)
 - [SCPI Command Tree](#)
-

SENSe<cnum>:SWEep:DWELI <num>

Applicable Models: E5080A, M9485A

(Read-Write) Sets the dwell time between each sweep point.

- Dwell time is **ONLY** available with SENS:SWE:GEN set to **STEPped**; It is **Not** available in **ANALOG**.
- Sending dwell = 0 is the same as setting SENS:SWE:DWEL:AUTO **ON**. Sending a dwell time > 0 sets SENS:SWE:DWEL:AUTO **OFF**.

Parameters

<cnum> Any existing channel number. If unspecified, value is set to 1

<num> Dwell time in seconds.

This command will accept **MIN** or **MAX** instead of a numeric parameter. See [SCPI Syntax](#) for more information.

Examples

```
SENS:SWE:DWEL .1
sense2:sweep:dwelli min
```

Query Syntax SENSe<cnum>:SWEep:DWELI?

Return Type Numeric

Default 0 - (**Note:** dwell time set to 0 is the same as dwell:auto ON)

SENSe<cnum>:SWEep:DWELI:AUTO <bool>

Applicable Models: E5080A, M9485A

(Read-Write) Specifies whether or not to automatically calculate and set the minimum possible dwell time. Setting Auto **ON** has the same effect as setting dwell time to **0**.

Parameters

<cnum> Any existing channel number. If unspecified, value is set to 1

<bool> **ON** (or 1) - turns dwell ON.
OFF (or 0) - turns dwell OFF.

Examples

```
SENS:SWE:DWEL:AUTO ON
sense2:sweep:dwell:auto off
```

Query Syntax SENSe<cnum>:SWEep:DWELI:AUTO?

Return Type Boolean (1 = ON, 0 = OFF)

Default ON

SENSe<cnum>:SWEep:DWELI:SDELay <num>**Applicable Models:** E5080A, M9485A

(Read-Write) Specifies the time to wait just before acquisition begins for each sweep. This delay is in addition to [Dwell Time](#) and the following two External Trigger delays if enabled.

- [Trig:Delay](#) (global scope)
- [Sens:Swe:Trig:Delay](#) (channel scope)

Parameters

<cnum> Any existing channel number. If unspecified, value is set to 1

<num> Sweep delay in seconds.

This command will accept **MIN** or **MAX** instead of a numeric parameter. See [SCPI Syntax](#) for more information.

Examples

```
SENS:SWE:DWEL:SDEL .1
sense2:sweep:dwel:sdelay .5
```

Query Syntax SENSe<cnum>:SWEep:DWELI:SDELay?

Return Type Numeric

Default 0

SENSe<cnum>:SWEep:GENeration <char>**Applicable Models:** E5080A

(Read-Write) Sets sweep as Stepped or Analog.

Parameters

<cnum> Any existing channel number. If unspecified, value is set to 1

<char> Choose from:

STEPped - source frequency is CONSTANT during measurement of each displayed point. More accurate than ANALog. Dwell time can be set in this mode.

ANALog (Auto) - source frequency is continuously RAMPING during measurement of each displayed point. Faster than STEPped. Sweep time (not dwell time) can be set in this mode.

Examples

```
SENS:SWE:GEN STEP
sense2:sweep:generation analog
```

Query Syntax SENSe<cnum>:SWEep:GENeration?

Return Type Character

Default STEPped

SENSe<cnum>:SWEep:GROups:COUNT <num>

Applicable Models: E5080A, M9485A

(Read-Write) Sets the trigger count (groups) for the specified channel. Set trigger mode to group after setting this count.

Parameters

<cnum> Any existing channel number. If unspecified, value is set to 1

<num> Count (groups) number. Choose any number between: 1 and **2e6** (1 is the same as single trigger)

Examples

```
SENS:SWE:GRO:COUN 10
sense2:sweep:groups:count 50
```

Query Syntax SENSe<cnum>:SWEep:GROups:COUNT?

Return Type Numeric

Default 1

SENSe<cnum>:SWEep:MODE <char>

Applicable Models: E5080A, M9485A

(Read-Write) Sets the number of trigger signals the specified channel will ACCEPT.

See [Triggering the VNA Using SCPI](#).

Parameters

<cnum> Any existing channel number. If unspecified, value is set to 1

<char> Trigger mode. Choose from:

HOLD - channel will not trigger

CONTInuous - channel triggers indefinitely

GRoups - channel accepts the number of triggers specified with the last [SENS:SWE:GRO:COUN <num>](#). This is one of the VNA overlapped commands. [Learn more](#).

SINGle - channel accepts ONE trigger, then goes to HOLD.

Note: To perform simple, single-triggering, use SINGle which requires that [TRIG:SOURce](#) remain in the default (internal) setting.

Examples `SENS:SWE:MODE CONT`
`sense2:sweep:mode hold`

Query Syntax `SENSe<cnum>:SWEep:MODE?`

Return Type Character

Default CONTInuous

SENSe<cnum>:SWEep:POINts <num>

Applicable Models: E5080A, M9485A

(Read-Write) Sets the number of data points for the measurement.

Parameters

<cnum> Any existing channel number. If unspecified, value is set to 1

<num> Choose any number between **1** and the VNA maximum number of points. This command will accept **MIN** or **MAX** instead of a numeric parameter. See [SCPI Syntax](#) for more information.

Examples `SENS:SWE:POIN 51`
`sense2:sweep:points max`

Query Syntax `SENSe<cnum>:SWEep:POINts?`

Return Type Numeric

Default 201

SENSe<cnum>:SWEep:SLOCAl:MAXimum <num>

Applicable Models: E5080A

(Read-Write) Sets the Shift LO maximum frequency for the selected channel.

Parameters

<cnum> Any existing channel number. If unspecified, value is set to 1

<num> Range of shift LO maximum frequency is 1.5E8 to Maximum frequency.

Examples `SENS:SWE:SCLOC:MAX 1.5E8`
`sense2:sweep:slocal:maximum 1.5E8`

Query Syntax `SENSe<cnum>:SWEep:SLOCAl:MAXimum?`

Return Type Numeric / Double precision floating point

Default Maximum frequency

SENSe<cnum>:SWEep:SLOCAl:STATe <bool>

Applicable Models: E5080A

(Read-Write) Turns ON or OFF the Shift LO mode for the selected channel.

Parameters

<cnum> Any existing channel number. If unspecified, value is set to 1

<bool> Select shoft LO mode from either of the following:

ON or 1 - Turns ON the Shift LO mode.

OFF or 0 - Turns OFF the Shift LO mode.

Examples

```
SENS:SWE:SLOC:STAT ON
sense2:sweep:slocal:state off
```

Query Syntax SENSe<cnum>:SWEep:SLOCAl:STATe?

Return Type Boolean

Default OFF or 0

SENSe<cnum>:SWEep:SPEEd <char>

Applicable Models: M9485A

(Read-Write) Sets and returns the state of Fast Sweep mode. [Learn more about Fast Sweep.](#)

Parameters

<cnum> Any existing channel number. If unspecified, value is set to 1

<char> Fast Sweep mode. Choose from:

FAST - turns Fast Sweep Mode ON

NORMal - turns Fast Sweep Mode OFF (Normal Mode).

Examples

```
SENS:SWE:SPE NORM
sense2:sweep:speed fast
```

Query Syntax SENSe<cnum>:SWEep:SPEEd?

Return Type Character

Default NORMal

SENSe<cnum>:SWEep:STEP <num>

Applicable Models: E5080A, M9485A

(Read-Write) Sets the step of stimulus

Parameters

<cnum> Any existing channel number. If unspecified, value is set to 1

<num> Value of step for each points in stimulus

Examples

```
SENS:SWE:STEP 1e3
sense2:sweep:step 1000
```

Query Syntax SENSe<cnum>:SWEep:STEP?

Return Type Numeric

Default Not Applicable

SENSe<cnum>:SWEep:TIME <num>

Applicable Models: E5080A, M9485A

(Read-Write) Sets the time the analyzer takes to complete one sweep. If sweep time accuracy is critical, use ONLY the values that are attained using the up and down arrows next to the sweep time entry box. [See Sweep Time.](#)

Parameters

<cnum> Any existing channel number. If unspecified, value is set to 1

<num> Sweep time in seconds.

To select the fastest sweep speed, either send MIN as an argument to this command, or send SENS:SWE:TIME:AUTO 1.

This command will accept **MIN** or **MAX** instead of a numeric parameter. See [SCPI Syntax](#) for more information.

The MAX value will change based on point count, IFBW, and dwell time.

Examples

```
SENS:SWE:TIME 1ms
sense2:sweep:time .001
```

Query Syntax SENSe<cnum>:SWEep:TIME?

Return Type Numeric
Default Not Applicable

SENSe<cnum>:SWEep:TIME:AUTO <bool>

Applicable Models: E5080A, M9485A

(Read-Write) Turns the automatic sweep time function ON or OFF.

Parameters

<cnum> Any existing channel number. If unspecified, value is set to 1
 <bool> **ON** (or 1) - turns the automatic sweep time ON.
OFF (or 0) - turns the automatic sweep time OFF.

Examples `SENS:SWE:TIME:AUTO`
`sense2:sweep:time:auto off`

Query Syntax SENSe<cnum>:SWEep:TIME:AUTO?

Return Type Boolean (1 = ON, 0 = OFF)

Default ON

SENSe<cnum>:SWEep:TRIGger:DELay <num>

Applicable Models: E5080A, M9485A

(Read-Write) Sets and reads the trigger delay for all measurements in the specified CHANNEL. This delay is only applied while [TRIG:SOURce EXTERNAL](#) and [TRIG:SCOP CURRENT](#). After an external trigger is applied, the start of the sweep is delayed for the specified delay value plus any inherent latency.

To apply a trigger delay for all channels (Global), use [TRIG:DEL](#)

Parameters

<cnum> Any existing channel number. If unspecified, value is set to 1
 <num> Trigger delay value in seconds. Range is from 0 to 107 seconds

Examples `SENS:SWE:TRIG:DELay .003`
`sense2:sweep:trigger:delay 1`

Query Syntax SENSe<cnum>:SWEep:TRIGger:DELay?

Return Type Numeric

Default 0

SENSE<cnum>:SWEep:TRIGger:MODE <char>

Applicable Models: E5080A, M9485A

(Read-Write) Sets and reads the trigger mode for the specified channel. This determines what EACH signal will trigger. [Learn more.](#)

Note: Setting Point and Sweep mode forces [Trigger:SCOPE](#) = CURRent

Parameters

<cnum> Any existing channel number. If unspecified, value is set to 1

<char> Trigger mode. choose from:

- **CHANnel** - Each trigger signal causes **ALL traces** in that channel to be swept.
- **SWEep** - Each Manual or External trigger signal causes **ALL traces that share a source port** to be swept.
- **POINT** - Each Manual or External trigger signal causes one data point to be measured.

Examples

```
SENS:SWE:TRIG:MODE SWE
sense2:sweep:trigger:mode point
```

Query Syntax SENSE<cnum>:SWEep:TRIGger:MODE?

Return Type Character

Default Channel

SENSE<cnum>:SWEep:TYPE <char>

Applicable Models: E5080A, M9485A

(Read-Write) Sets the type of analyzer sweep mode. First set sweep type, then set sweep parameters such as frequency or power settings.

Note: For SweptIMD channels, use SENS:IMD:SWE:TYPE SEGMENT

See Also: FCA Segment Sweep commands

Parameters

<cnum> Any existing channel number. If unspecified, value is set to 1

<char> Choose from:

LINEar | LOGarithmic | POWER | CW | SEGMENT

Note: SWEep TYPE cannot be set to SEGMENT if there are no segments turned ON.

A segment is automatically turned ON when the analyzer is started.

Examples `SENS:SWE:TYPE LIN`
`sense2:sweep:type segment`

Query Syntax `SENSe<num>:SWEp:TYPE?`

Return Type Character

Default LINear

Last Modified:

29-Sep-2015 First Release



Source Commands

Controls the power delivered to the DUT.

```

SOURce:
  CATalog?
  POWer
    | ALC[:MODE]
      | CATalog?
    | CENTer
    | CORRection - More commands
    | COUPle
    | [LEVel]
      | [IMMediate][AMPLitude]
      | SLOPe
        | STATe
    | MODE
    | PORT
      | START
      | STOP
    | SPAN
    | START
    | STOP

```

Click on a **Red** keyword to view the command details.

See Also

- Example Programs
- [Learn about Power Settings](#)
- [Synchronizing the VNA and Controller](#)
- [SCPI Command Tree](#)
- Remotely Specifying a Source Port

SOURce<cnum>:CATalog?

Applicable Models: E5080A, M9485A

(Read-only) Returns a list of valid port names that can be controlled. Some ports only have string names,

NOT numbers. All commands that require a port argument have provisions for specifying either a port number OR a string name.

See also: Remotely Specifying a Source Port.

Parameters

<cnum> Any existing channel number. If unspecified, value is set to 1

Examples

```
SOUR:CAT?
source:catalog

'VNA models return
"Port 1,Port 2,Port 3,Port 4, MXG"
```

Return Type Comma-separated list of strings.

Default Not Applicable

[SOURce<cnum>:POWER<port>:ALC\[:MODE\] <char>, \[src\]](#)

Applicable Models: M9485A

(Read-Write) Sets and returns the ALC mode for the specified channel and port. Use [SOUR:POW:ALC:MODE:CAT?](#) to return a list of valid ALC modes for the VNA.

[Learn more about ALC mode.](#)

Parameters

<cnum> Any existing channel number. If unspecified, value is set to 1

<port> Source port number of the VNA. If unspecified, value is set to 1. To make settings for ports that are not simple numbers, use the [src] argument.

<char> ALC Mode.

For the VNA choose from:

- **INTernal** Standard ALC loop
- **OPENloop** No ALC loop

[src] **String**. (NOT case sensitive). Source port. Optional. Use [SOUR:CAT?](#) to return a list of valid port names

Examples

```
SOUR:POW:ALC INT
source2:power2:alc:mode openloop
source:power:alc:mode openloop,"Port 1 Src2"
```

Query Syntax SOURce<cnum>:POWER<port>:ALC:MODE? [src]

Return Type Character

Default INTERNAL

SOURce<num>:POWER<port>:ALC[:MODE]:CATalog? [src]

Applicable Models: M9485A

(Read-only) Returns a list of valid ALC modes for the specified channel and port number. Use the returned values to set [SOUR:POW:ALC:MODE](#).

Parameters

- <num> Any existing channel number. If unspecified, value is set to 1
- <port> Source port number of the VNA. If unspecified, value is set to 1. To make settings for ports that are not simple numbers, use the [src] argument.
- [src] **String**. (NOT case sensitive). Source port. Optional. Use [SOUR:CAT?](#) to return a list of valid port names.
- While this argument can be used to make settings for ALL ports, it is designed to access ports such as an [external source](#), true mode balanced port, or one of the Source 2 outputs on the 2-port 2-source VNA model such as "Port 1 Src2". Otherwise, the <port> argument performs the same function. If both arguments are specified, [src] takes priority.

Examples

```
SOUR:POW:ALC:CAT?
source2:power2:alc:mode:catalog?
source:power:alc:mode:catalog? "Port 1 Src2"
```

Return Type Comma-separated list of strings.

Default Not applicable

SOURce<num>:POWER<port>:CENTer <num>

Applicable Models: E5080A, M9485A

(Read-Write) Sets the power sweep center power. Must also set: [SENS:SWE:TYPE POWER](#) and [SOURce:POWER:SPAN <num>](#).

Parameters

- <num> Any existing channel number. If unspecified, value is set to 1
- <num> Center power. Actual achievable leveled power depends on frequency.
- <port> If provided, this argument is **ignored** by the VNA.

Examples `SOUR:POW:CENT -15`

```
source2:power:center -7
```

Query Syntax SOURce<cnum>:POWER:CENTer?

Return Type Numeric

Default 0 dBm

SOURce<cnum>:POWER<port>:COUPle <bool>

Applicable Models: E5080A, M9485A

(Read-Write) Turns Port Power Coupling ON or OFF.

Parameters

<cnum> Any existing channel number. If unspecified, value is set to 1

<bool> **ON** (or 1) - turns coupling ON. The same power level is used for both source ports.
OFF (or 0) - turns coupling OFF. Power level can be set individually for each source port.

<port> If provided, this argument is **ignored** by the VNA.

Examples

```
SOUR:POW:COUP ON
source2:power:couple off
```

Query Syntax SOURce<cnum>:POWER:COUPle?

Return Type Boolean (1 = ON, 0 = OFF)

Default ON

SOURce<cnum>:POWER<port>[:LEVel][:IMMediate][:AMPLitude] <num>, [src]

Applicable Models: E5080A, M9485A

(Read-Write) Sets the RF power output level.

Parameters

<cnum> Any existing channel number. If unspecified, value is set to 1

<port> Source port number of the VNA. If unspecified, value is set to 1. To make settings for ports that are not simple numbers, use the [src] argument.

<num> Source power in dBm.

Note: The range of settable power values depends on the VNA model and if source attenuators are installed. To determine the range of values, perform a query using MAX, then MIN, as an argument. ([SOUR:POW:ATT:AUTO](#) must be set to ON)
 Example: SOURce:POWER? Max

Actual achievable leveled power depends on frequency.

[src] **String**. (NOT case sensitive). Source port. Optional. Use [SOUR:CAT?](#) to return a list of valid port names.

While this argument can be used to make settings for ALL ports, it is designed to access ports such as an [external source](#), true mode balanced port, or one of the Source 2 outputs on the 2-port 2-source VNA model such as "Port 1 Src2". Otherwise, the <port> argument performs the same function. If both arguments are specified, [src] takes priority.

Examples

```
SOUR:POW1 5
source2:power:level:immediate:amplitude maximum
sour:pow 5, "Port 1 Src2"
```

Query Syntax SOURce<num>:POWER[:LEVel][:IMMediate][:AMPLitude]? [src]

Return Type Numeric

Default 0 dBm

[SOURce<num>:POWER<port>\[:LEVel\]:SLOPe <num>](#)

Applicable Models: E5080A, M9485A

(Read-Write) Sets the RF power slope value.

Also enable the slope state using [SOUR:POW:SLOP:STAT ON](#).

Parameters

- <num> Any existing channel number. If unspecified, value is set to 1
- <num> Slope value in db/GHz. Choose any value between **-2** and **2** (0 is no slope).
- <port> If provided, this argument is **ignored** by the VNA.

Examples

```
SOUR:POW:SLOP .5234434
source2:power:level slope -1.345
```

Query Syntax SOURce<num>:POWER[:LEVel]:SLOPe?

Return Type Numeric

Default 0

[SOURce<num>:POWER<port>\[:LEVel\]:SLOPe:STATe <bool>](#)

Applicable Models: E5080A, M9485A

(Read-Write) Turns Power Slope ON or OFF. Set the slope using [SOUR:POW:SLOP](#).

Parameters

- <num> Any existing channel number. If unspecified, value is set to 1

- <bool> **ON** (or 1) - turns slope ON.
OFF (or 0) - turns slope OFF.
- <port> If provided, this argument is **ignored** by the VNA.

Examples

```
SOUR:POW:SLOP:STAT ON
source2:power:slope:state off
```

Query Syntax SOURce<num>:POWER[:LEVEl]:SLOPe:STATe?

Return Type Boolean (1 = ON, 0 = OFF)

Default OFF

[SOURce<num>:POWER<port>:MODE <state>, \[src\]](#)

Applicable Models: E5080A, M9485A

(Read-Write) Sets the state of VNA source for the specified port.

Parameters

- <num> Any existing channel number. If unspecified, value is set to 1
- <port> Source port number of the VNA. If unspecified, <port> is set to 1. To make settings for ports that are not simple numbers, use the [src] argument.
- <state> Source state. Choose from:
- **AUTO** Source power is turned ON when required for a measurement.
 - **ON** Source power is always ON regardless of the measurement.
 - **OFF** Source power is always OFF regardless of the measurement.
- [src] **String.** (NOT case sensitive). Source port. Optional. Use [SOUR:CAT?](#) to return a list of valid port names.
- While this argument can be used to make settings for ALL ports, it is designed to access ports such as an [external source](#), true mode balanced port, or one of the Source 2 outputs on the 2-port 2-source VNA model such as "Port 1 Src2". Otherwise, the <port> argument performs the same function. If both arguments are specified, [src] takes priority.

Examples

```
SOUR:POW:MODE ON
source2:power4:mode OFF
sour:pow:mode on, "Port 1 Src2"
```

Query Syntax SOURce<num>:POWER<port>:MODE? [src]

Return Type Character

Default Auto

SOURce<num>:POWer<port>:PORT:STARt <num>, [src]

Applicable Models: E5080A, M9485A

(Read-Write) Sets and reads the power sweep start power value for a specific port. This allows uncoupled forward and reverse power sweep ranges. Must also set [SENS:SWE:TYPE POWER](#) and [SOUR:POW:COUPlE OFF](#).

Parameters

<num> Any existing channel number. If unspecified, value is set to 1

<port> Source port number of the VNA. If unspecified, <port> is set to 1. To make settings for ports that are not simple numbers, use the [src] argument.

<num> Start power in dBm.

Note: The range of settable power values depends on the VNA model and if source attenuators are installed. To determine the range of values, perform a query using MAX, then MIN, as an argument. ([SOUR:POW:ATT:AUTO](#) must be set to ON)
Example: SOURce:POWer:STARt? MIN

Actual achievable leveled power depends on frequency.

[src] **String.** (NOT case sensitive). Source port. Optional. Use [SOUR:CAT?](#) to return a list of valid port names.

While this argument can be used to make settings for ALL ports, it is designed to access ports such as an [external source](#), true mode balanced port, or one of the Source 2 outputs on the 2-port 2-source VNA model such as "Port 1 Src2".

Otherwise, the <port> argument performs the same function. If both arguments are specified, [src] takes priority.

Examples

```
SOUR:POW1:PORT:STAR -15
source2:power:port:start 5, "bal port 1"
```

Query Syntax SOURce<num>:POWer<port>:PORT:STARt? [src]

Return Type Numeric

Default -10 dBm

SOURce<num>:POWer<port>:PORT:STOP <num>, [src]

Applicable Models: E5080A, M9485A

(Read-Write) Sets and reads the power sweep stop power value for a specific port. This allows uncoupled forward and reverse power sweep ranges. Must also set [SENS:SWE:TYPE POWER](#) and [SOUR:POW:COUPlE OFF](#).

Parameters

<num> Any existing channel number. If unspecified, value is set to 1

<port> Source port number of the VNA. If unspecified, <port> is set to 1. To make settings for ports that are not simple numbers, use the [src] argument.

<num> Stop power in dBm.

Note: The range of settable power values depends on the VNA model and if source attenuators are installed. To determine the range of values, perform a query using MAX, then MIN, as an argument. ([SOUR:POW:ATT:AUTO](#) must be set to ON)
Example: SOURce:POWer:STARt? MIN

Actual achievable leveled power depends on frequency.

[src] **String.** (NOT case sensitive). Source port. Optional. Use [SOUR:CAT?](#) to return a list of valid port names.

While this argument can be used to make settings for ALL ports, it is designed to access ports such as an [external source](#), true mode balanced port, or one of the Source 2 outputs on the 2-port 2-source VNA model such as "Port 1 Src2".

Otherwise, the <port> argument performs the same function. If both arguments are specified, [src] takes priority.

Examples `SOUR:POW1:PORT:STOP -15`
`source2:power:port:stop 5, "bal port 1"`

Query Syntax SOURce<cnum>:POWer<port>:PORT:STOP? [src]

Return Type Numeric

Default 0 dBm

[SOURce<cnum>:POWer<port>:SPAN <num>](#)

Applicable Models: E5080A, M9485A

(Read-Write) Sets the power sweep span power. Must also set:

[SENS:SWE:TYPE Power](#) and [SOURce:POWer:CENTer <num>](#).

Parameters

<cnum> Any existing channel number. If unspecified, value is set to 1.

<num> Span power. Actual achievable leveled power depends on frequency.

<port> If provided, this argument is **ignored** by the VNA.

Examples `SOUR:POW:SPAN -15`
`source2:power:span -7`

Query Syntax SOURce<cnum>:POWer:SPAN?

Return Type Numeric

Default 10 dBm

[SOURce<cnum>:POWer<port>:STARt <num>](#)

Applicable Models: E5080A, M9485A

(Read-Write) Sets the power sweep start power for ALL ports being used by the specified channel. Must also set:

[SENS:SWE:TYPE POWER](#) and [SOURce:POWer:STOP <num>](#).

To set start power for a specific port, use [SOUR:POW:PORT:START](#).

Parameters

<cnum> Any existing channel number. If unspecified, value is set to 1

<num> Start power.

Note: The range of settable power values depends on the VNA model and if source attenuators are installed. To determine the range of values, perform a query using MAX, then MIN, as an argument. ([SOUR:POW:ATT:AUTO](#) must be set to ON)
Example: SOURce:POWer:START? MIN

Actual achievable leveled power depends on frequency.

<port> If provided, this argument is **ignored** by the VNA.

Examples

```
SOUR:POW:STAR -15
source2:power:start -7
```

Query Syntax SOURce<cnum>:POWer:START?

Return Type Numeric

Default -10 dBm

[SOURce<cnum>:POWer<port>:STOP <num>](#)

Applicable Models: E5080A, M9485A

(Read-Write) Sets the power sweep stop power for ALL ports being used by the specified channel.. Must also set: [SENS:SWE:TYPE POWER](#) and [SOURce:POWer:START <num>](#).

To set start power for a specific port, use [SOUR:POW:PORT:STOP](#).

Parameters

<cnum> Any existing channel number. If unspecified, value is set to 1

<num> Stop power.

Note: The range of settable power values depends on the VNA model and if source attenuators are installed. To determine the range of values, perform a query using MAX, then MIN, as an argument. ([SOUR:POW:ATT:AUTO](#) must be set to ON)
Example: SOURce:POWer:STOP? MAX

Actual achievable leveled power depends on frequency.

<port> If provided, this argument is **ignored** by the VNA.

Examples `SOUR:POW:STOP -15`
`source2:power:stop -7`

Query Syntax `SOURce<cnum>:POWer:STOP?`

Return Type Numeric

Default 0 dBm

Last Modified:

29-Sep-2015 First Release



Source:Power:Correction Commands

Used to perform source power calibration on internal and external sources.

Note: Only ONE Source Power Cal can be performed at a time.

SOURce:POWer:CORREction:

COLLect

- | [ABORt](#)
- | [\[ACQuire\]](#)
- | AVERage
 - | [\[COUnT\]](#)
 - | [NTOLerance](#)
- | DISPlay
 - | [\[STATe\]](#)
- | FCHeck]
 - | [\[STATe\]](#)
- | ITERation
 - | [\[COUnT\]](#)
 - | [NTOLerance](#)

| [SAVE](#)

- | SENSor
 - | [\[FRANge\]](#)
 - | [RCFactor](#)
 - | [SElect](#)

| TABLE

- | [DATA](#)
- | [FREQuency](#)
- | LOSS
 - | [\[STATe\]](#)
- | [POINts?](#)
- | [\[SElect\]](#)

DATA

- | [PRIor](#)

LEVel [\[AMPLitude\]](#)

OFFSet

- | [\[MAGNitude\]](#)

[\[STATe\]](#)

Click on a [Red](#) keyword to view the command details.

[Red](#) commands are superseded.

See Also

- Example program using these commands.

- Template for creating your own Power Meter Driver
- [Learn about Source Power Cal](#)
- [Synchronizing the VNA and Controller](#)
- [SCPI Command Tree](#)

Note: The [SOURce:POWer:CORRection:COLLect:ACQuire](#) command, used to step the VNA and read a power meter, cannot be sent over the GPIB unless the power meter is connected to a different GPIB interface. See the alternative methods described in the command details.

[SOURce<ch>:POWer<port>:CORRection:COLLect:ABORt](#)

Applicable Models: E5080A, M9485A

(Write-only) Aborts a source power calibration sweep that is in progress.

To use this ABORt command, you MUST use the **ASYNchronous** argument with [SOUR:POW:CORR:COLL:ACQ](#)

After aborting, this message appears in the error log: **+243,"Requested operation was canceled".**

Parameters

<ch> Channel number of the source power cal. If unspecified, value is set to 1

<port> Port number to correct for source power. If unspecified, value is set to 1.

Examples

```
SOUR:POW:CORR:COLL:ABOR
source1:power2:correction:collect:abort
```

Query Syntax Not Applicable

Default Not Applicable

[SOURce<ch>:POWer<port>:CORRection:COLLect\[:ACQuire\] <char>,<id>\[,src\]\[,sync\]](#)

Applicable Models: E5080A, M9485A

Note: With VNA Rev. 6.2, a new "id" argument has been added to this command, replacing [SOUR:POW:CORR:COLL:METH](#).

(Write-only) Initiates a source power cal acquisition sweep using the power sensor attached to the specified channel (A or B) on the power meter, using a USB power sensor, or using the specified VNA receiver.

For source power cal, the power meter can NOT be controlled by the VNA using the GPIB Talker/Listener interface. Instead use one of the following methods:

- If present, use the GPIB dedicated controller port.
- Connect the power meter to the VNA using a [USB / GPIB interface](#) (Keysight 82357B).
- SCPI programming of the VNA using a LAN Client interface (see example).
- Send SCPI commands through the COM interface using the SCPI String Parser object.
- Directly control the Power Meter and VNA to step frequency; then acquire and store the Power reading. (see example).

- Configure the Power Meter/Sensor as a PMAR Device. [Learn how.](#) [See SCPI commands.](#)

Parameters

<ch> Channel number of the source power cal. If unspecified, value is set to 1

<port> Port number to correct for source power. If unspecified, value is set to 1.

<char> Acquisition Choose from:

- **PMETer** - Power Meter is used for all readings.
- **PMReceiver** - Power meter for the first iteration; then use the reference receiver for remaining readings if necessary (same as "fast iteration" box checked on [dialog box](#))
- **RECeiver** - Use VNA measurement receiver for all readings.

<id> **String** (Not case sensitive). The power sensor or VNA receiver to use for measuring power.

For **PMETer** or **PMRECeiver**, choose from:

- **"ASENSOR"** or **"BSENSOR"**. For U series USB sensors, always specify **"ASENSOR"**

For **RECeiver**, choose from:

- Any VNA receiver to acquire readings using physical or [logical receiver notation](#).
- Any configured PMAR device name. [Learn more about PMAR Devices.](#) [See PMAR commands.](#)

[src] Optional argument. **String**. (NOT case sensitive). Source port. Use [SOUR:CAT?](#) to return a list of valid port names.

While this argument can be used to make settings for ALL ports, it is designed to access ports that are not simple numbers, such as "Port 1 Src2". Otherwise, the <port> argument performs the same function. If both arguments are specified, [src] takes priority.

[sync] If this argument is specified, must also specify [src].

Choose from:

- **SYNChronous** - Blocks SCPI commands during standard measurement (default behavior).
- **ASYNchronous** - Does NOT block SCPI commands during standard measurement.

[Learn more about this argument](#)

Examples

```
SOUR:POW:CORR:COLL PMET,"ASENSOR","Port 1",ASYN 'acquires
power meter readings using the A sensor, source port 1,
asynchronous.
sourcel:power2:correction:collect:acquire receiver,"a1"
'acquires source cal readings using the reference receiver
for port 1.
```

Query Syntax Not Applicable

Default Not Applicable

SOURce<ch>:POWER<port>:CORRection:COLLect:AVERage[:COUNT] <num>

Applicable Models: E5080A, M9485A

(Read-Write) This command, along with [SOUR:POW:CORR:COLL:AVER:NTOLerance](#), allows for settling of the power sensor READINGS.

Sets the maximum number of acquisitions that will be used to acquire one **settled reading** from the power meter. These settings affect every use of the power meter (PMAR and source power cal).

When this average meets the [Average:NTOLerance](#) value or this number of readings has been made, the average is returned as the valid reading.

This setting is not necessary when using a VNA receiver ([SOUR:POW:CORR:COLL REC](#)) to make the measurement.

[Learn more.](#)

Parameters

<ch> If provided, this argument is **ignored** by the VNA.

<port> If provided, this argument is **ignored** by the VNA.

<num> Maximum number of readings to make to allow for settling. Choose any number between 3 and 1000.

Examples

```
SOUR:POW:CORR:COLL:AVER 2
source:power:correction:collect:average:count 3
```

Query Syntax SOURce:POWER:CORRection:COLLect:AVERage[:COUNT]?

Return Type Numeric

Default 3

SOURce<ch>:POWER<port>:CORRection:COLLect:AVERage:NTOLerance <num>

Applicable Models: E5080A, M9485A

(Read-Write) This command, along with [SOUR:POW:CORR:COLL:AVER:COUNT](#), allows for settling of the power sensor READINGS.

Each power reading is averaged with the previous readings at each stimulus point. When the average meets this nominal tolerance value or the [max number of readings](#) has been made, the average is returned as the valid reading.

This setting is not necessary when using a VNA receiver ([SOUR:POW:CORR:COLL REC](#)) to make the measurement.

[Learn more.](#)

Parameters

- <ch> If provided, this argument is **ignored** by the VNA.
- <port> If provided, this argument is **ignored** by the VNA.
- <num> Power measurement settling tolerance value in dB. Choose any number between 0 and 5.

Examples

```
SOUR:POW:CORR:COLL:AVER:NTOL .05
source1:power2:correction:collect:average:ntolerance .003
```

Query Syntax SOURce:POWer:CORRection:COLLect:AVERage:NTOLerance?

Return Type Numeric

Default .050 dBm

[SOURce<ch>:POWer<port>:CORRection:COLLect:DISPlay\[::STATe\] <bool>](#)

Applicable Models: E5080A, M9485A

(Read-Write) Enables and disables the display of power readings on the VNA screen. Send this command BEFORE you begin a source power cal acquisition. After the source power cal data is acquired, this setting is reset to ON.

Parameters

- <ch> Channel number of the source power cal. If unspecified, value is set to 1
- <port> If provided, this argument is **ignored** by the VNA.
- <ON|OFF> **ON (1)** Source power calibration dialog box is shown on the VNA screen. Power readings are plotted against the Tolerance value as limit lines.
OFF (0) - Source power calibration dialog box is NOT shown on the VNA screen.

Examples

```
SOUR:POW:CORR:COLL:DISP ON
source1:power2:correction:collect:display:state off
```

Query Syntax SOURce:POWer:CORRection:COLLect:DISPlay[::STATe]?

Return Type Boolean (1 = ON, 0 = OFF)

Default ON (1)

[SOURce<ch>:POWer<port>:CORRection:COLLect:FCHeck\[::STATe\] <bool>](#)

Applicable Models: E5080A, M9485A

(Read-Write) Enables and disables frequency checking of source power cal acquisition sweeps. ONLY use when you have more than one power sensor.

Parameters

- <ch> Channel number of the source power cal. If unspecified, value is set to 1
- <port> If provided, this argument is **ignored** by the VNA.
- <ON|OFF> **ON (1)** turns source power cal frequency checking ON. A requested acquisition will only succeed for those frequency points which fall within a frequency range specified for the power sensor being used. An acquisition will pause in mid-sweep if the frequency is about to exceed the maximum frequency limit specified for that sensor. When the sweep is paused in this manner, a sensor connected to the other channel input of the power meter can be connected to the measurement port in place of the previous sensor, and used to complete the sweep. However, the maximum frequency specified for the second sensor would need to be sufficient for the sweep to complete. Frequency limits are specified using the [SOUR:POW:CORR:COLL:SEN](#) command.
- OFF (0)** - turns source power cal frequency checking OFF. An acquisition will use just one power sensor for the entire sweep, regardless of frequency.

Examples

```
SOUR:POW:CORR:COLL:FCH ON
source1:power2:correction:collect:fcheck:state off
```

Query Syntax SOURce:POWER:CORRection:COLLect:FCHeck[:STATe]?

Return Type Boolean (1 = ON, 0 = OFF)

Default OFF (0)

[SOURce<ch>:POWER<port>:CORRection:COLLect:ITERation\[:COUNT\] <num>](#)

Applicable Models: E5080A, M9485A

(Read-Write) This command, along with [SOUR:POW:CORR:COLL:ITER:NTOL](#) describes the number of adjustments to set the power to a desired level.

These settings determine how many attempts (COUNT) the analyzer will make in an attempt to get close enough (NTOLerance) to the target power level.

[Learn more.](#)

Parameters

- <ch> If provided, this argument is **ignored** by the VNA.
- <port> If provided, this argument is **ignored** by the VNA.
- <num> Maximum number of readings. Choose any number between 1 and 1000.

Examples

```
SOUR:POW:CORR:COLL:ITER 2
source:power:correction:collect:iteration 3
```

Query Syntax SOURce:POWER:CORRection:COLLect:ITERation[:COUNT]?

Return Type Numeric

Default 1

SOURce<ch>:POWER<port>:CORRection:COLLect:ITERation:NTOLerance <num>

Applicable Models: E5080A, M9485A

(Read-Write) This command, along with [SOUR:POW:CORR:COLL:ITER:COUNT](#) describes the number of adjustments to make to the source power.

These settings determine how many attempts (COUNT) the analyzer will make in an attempt to get close enough (NTOLerance) to the target power level.

[Learn more.](#)

Parameters

- <ch> If provided, this argument is **ignored** by the VNA.
- <port> If provided, this argument is **ignored** by the VNA.
- <num> Tolerance value in dBm. Choose any number between 0 and 5

Examples

```
SOUR:POW:CORR:COLL:ITER:NTOL .005
source:power:correction:collect:iteration:ntolerance .1
```

Query Syntax SOURce:POWER:CORRection:COLLect:ITERation:NTOLerance?

Return Type Numeric

Default .05

SOURce<ch>:POWER<port>:CORRection:COLLect:<pmChan>SENsor[:FRANge] <num1>,<num2>

Applicable Models: E5080A, M9485A

(Read-Write) Specifies the frequency range over which the power sensors connected to the specified channels (A and B) of the power meter can be used (minimum frequency, maximum frequency). If the power meter has only a single channel, that channel is considered channel A.

Parameters

- <ch> Channel number of the source power cal. If unspecified, value is set to 1
- <port> If provided, this argument is **ignored** by the VNA.
- <pmChan> Power Meter channel. Choose from:
 - A** - Channel A
 - B** - Channel B

<num1> Minimum frequency for the sensor. If a frequency unit is not specified, Hz is assumed. No limits are placed on this value.

<num2> Maximum frequency for the sensor. If a frequency unit is not specified, Hz is assumed. No limits are placed on this value.

Examples

```
SOUR:POW:CORR:COLL:ASEN 100E3, 3E9
sourcel:power2:correction:collect:bsensor:frange 10 MHz, 18 GHz
```

Query Syntax SOURce:POWer:CORRection:COLLect:ASENsor[:FRANge]?
SOURce:POWer:CORRection:COLLect:BSEnSor[:FRANge]?

Return Type Numeric

Default 0,0

SOURce<ch>:POWer<port>:CORRection:COLLect:<pmChan>SENsor:RCFactor <num>

Applicable Models: E5080A, M9485A

(**Read-Write**) Specifies the reference cal factor for the power sensor connected to channel A or B of the power meter. If the power meter has only a single channel, that channel is considered channel A.

Note: If the sensor connected to the specified channel of the power meter contains cal factors in EPROM (such as the Keysight E-series power sensors), those will be the cal factors used during the calibration sweep. The reference cal factor value associated with this command, and any cal factors entered into the VNA for that sensor channel, will not be used.

Parameters

<ch> Channel number of the source power cal. If unspecified, value is set to 1

<port> If provided, this argument is **ignored** by the VNA.

<pmChan> Power Meter channel. Choose from:

A - Channel A

B - Channel B

<num> Reference cal factor in percent. Choose any number between 1 and 150.

Examples

```
SOUR:POW:CORR:COLL:ASEN:RCF 98.7
sourcel:power2:correction:collect:bsensor:rcfactor 105
```

Query Syntax SOURce:POWer:CORRection:COLLect:ASENsor:RCFactor?
SOURce:POWer:CORRection:COLLect:BSEnSor:RCFactor?

Return Type Numeric

Default 100

SOURce<ch>:POWer<port>:CORRection:COLLect:<pmChan>SENsor:SElect

Applicable Models: E5080A, M9485A

(Read-Write) Sets and returns the power sensor channel (A or B) to be used. This performs the same function as the **Use this sensor only** checkbox in the [Power Sensor Settings dialog](#).

Notes:

- This command is NOT necessary when performing a [Guided Power Cal using Multiple Sensors](#).
- This command can be used with Application channels.

Parameters

- <ch> Channel number of the source power cal. If unspecified, value is set to 1
- <port> If provided, this argument is **ignored** by the VNA.
- <pmChan> Power Meter channel. Choose from:
- A** - Channel A
 - B** - Channel B

Examples

```
SOUR:POW:CORR:COLL:<pmChan>SEN:SEL 'Write
source1:power2:correction:collect:bsensor:select? 1e9 'Read
```

Query Syntax

SOURce:POWer:CORRection:COLLect:ASENsor:SElect? <Frequency>
 SOURce:POWer:CORRection:COLLect:BSEnSor:SElect? <Frequency>
 Returns a boolean 1 or 0 (ON or OFF) indicating whether the sensor is to be used at the specified frequency.
 If [frequency checking](#) is OFF, then the <Frequency> parameter is ignored. The query returns if the sensor is selected for ALL frequencies.

Return Type Numeric

Default Not Applicable

SOURce<ch>:POWer<port>:CORRection:COLLect:TABLE:DATA <data>

Applicable Models: E5080A, M9485A

(Read-Write) Read or write data into the selected table. Use [SOUR:POW:CORR:COLL:TABL:SElect](#) to select a table.

- When the power sensor table is selected, the data is interpreted as cal factors in **percent**.
- When the loss table is selected, POSITIVE values in dB are interpreted as LOSS. To compensate for gain, use negative values.
- Each table can contain up to 9999 segments. Values can be loaded using the Characterize Adapter macro.
- Learn more about [Power Loss Compensation](#).

Parameters

- <ch> Channel number of the source power cal. If unspecified, value is set to 1

<port> If provided, this argument is **ignored** by the VNA.

<data> Data to write into the selected table.

Examples `SOURce:POWer:CORRection:COLLect:TABLE:DATA 0.12, 0.34, 0.56`

Query Syntax `SOURce<ch>:POWer:CORRection:COLLect:TABLE:DATA?`

If the selected table is currently empty, no data is returned.

Return Type Numeric - one number per table segment.

Default Not Applicable

`SOURce<ch>:POWer<port>:CORRection:COLLect:TABLE:FREQuency <data>`

Applicable Models: E5080A, M9485A

(Read-Write) Read or write frequency values for the selected table (cal factor table for a power sensor, or the loss compensation table). Use [SOUR:POW:CORR:COLL:TABL:SElect](#) to select a table.

Parameters

<ch> Channel number of the source power cal. If unspecified, value is set to 1

<port> If provided, this argument is **ignored** by the VNA.

<data> Frequency data to write into the selected table.

Examples `SOURce:POWer:CORRection:COLLect:TABLE:FREQuency 10E6, 1.5E9, 9E9`

Query Syntax `SOURce<ch>:POWer:CORRection:COLLect:TABLE:FREQuency?`

If the selected table is currently empty, no data is returned.

Return Type Numeric - one number per table segment

Default Not Applicable

`SOURce<ch>:POWer<port>:CORRection:COLLect:TABLE:LOSS[:STATE] <bool>`

Applicable Models: E5080A, M9485A

(Read-Write) Indicates whether or not to adjust the power readings using the values in the loss table during a source power cal sweep. Learn more about [Power Loss Compensation](#).

Parameters

<ch> Channel number of the source power cal. If unspecified, value is set to 1

<port> If provided, this argument is **ignored** by the VNA.

<bool> **ON (or 1)** - turns use of the loss table ON.
OFF (or 0) - turns use of the loss table OFF.

Examples `SOUR:POW:CORR:COLL:TABL:LOSS ON`
`source1:power2:correction:collect:table:loss:state off`

Query Syntax `SOURce:POWer:CORRection:COLLect:TABLE:LOSS[:STATe]?`

Return Type Boolean (1 = ON, 0 = OFF)

Default OFF (0)

[SOURce<ch>:POWer<port>:CORRection:COLLect:TABLE:POINts?](#)

Applicable Models: E5080A, M9485A

(Read-only) Returns the number of segments that are currently in the selected table.

Parameters

<ch> Channel number of the source power cal. If unspecified, value is set to 1
 <port> If provided, this argument is **ignored** by the VNA.

Examples `SOUR:POW:CORR:COLL:TABL:POIN?`
`source1:power2:correction:collect:table:points?`

Return Type Numeric

Default 0

[SOURce<ch>:POWer<port>:CORRection:COLLect:TABLE\[:SELEct\] <char>](#)

Applicable Models: E5080A, M9485A

(Read-Write) Selects which table you want to write to or read from. Read or write using

[SOURce:POWer:CORRection:COLLect:TABLE:FREQuency](#) and

[SOURce:POWer:CORRection:COLLect:TABLE:DATA](#)

Parameters

<ch> Channel number of the source power cal. If unspecified, value is set to 1
 <port> If provided, this argument is **ignored** by the VNA.
 <char> Choose from:
NONE - No table selected
ASENsor - Cal Factor table for Power Sensor A
BSENsor - Cal Factor table for Power Sensor B

LOSS - Loss compensation table

Examples `SOUR:POW:CORR:COLL:TABL ASEN`
`source1:power2:correction:collect:table:select bsensor`

Query Syntax `SOURce:POWer:CORRection:COLLect:TABLE[:SElect]?`

Return Type Character

Default NONE

`SOURce<ch>:POWer<port>:CORRection:DATA <data>[,src]`

Applicable Models: E5080A, M9485A

(Read-Write) Writes and reads source power calibration data.

The effect from this command on the channel is immediate. Do NOT send `SOUR:POW:CORR:COLL:SAVE` after this command as it may invalidate the uploaded data.

When querying source power calibration data, if no source power cal data exists for the specified channel and source port, then no data is returned.

If a change in the instrument state causes interpolation and/or extrapolation of the source power cal, the correction data associated with this command correspond to the new instrument state (interpolated and/or extrapolated data).

If the channel is sweeping the source backwards, then the first data point is the highest frequency value; the last data point is the lowest. Use the `SENS:X:VALues?` command to return the X-axis values in the displayed order.

Parameters

<ch> Channel number of the source power cal. If unspecified, value is set to 1

<port> Port number to correct for source power. If unspecified, value is set to 1.

<data> Correction Data

[src] **String**. (NOT case sensitive). Source port. Optional. Use [SOUR:CAT?](#) to return a list of valid port names.

While this argument can be used to make settings for ALL ports, it is designed to access ports that are not simple numbers, such as "Port 1 Src2". Otherwise, the <port> argument performs the same function. If both arguments are specified, [src] takes priority.

Examples `SOURce1:POWer2:CORRection:DATA 0.12, -0.34, 0.56`

Query Syntax `SOURce<ch>:POWer<port>:CORRection:DATA? [src]`

Return Type Depends on [FORMat:DATA](#) command

Default Not Applicable

`SOURce<ch>:POWer<port>:CORRection:DATA:PRlor <data>[,src]`

Applicable Models: E5080A, M9485A

(Read-Write) Writes and reads power correction values from the previous iteration of the source power cal. Data for which the first power meter reading were within the tolerance limit, the prior correction value is 0.

In all other respects, this command is the same as [SOUR:POW:CORR:DATA](#).

This command can be used to determine the final power reading at each point of the power cal, for a cal that did not pass tolerance limits. The formula for determining the power reading (in dB):

Power reading = Target power at the source port + specified power cal offset value + prior iteration corr value actual power corr value.

The "actual" value in this equation is returned with [SOUR:POW:CORR:DATA?](#)

Parameters

- <ch> Channel number of the source power cal. If unspecified, value is set to 1
- <port> Port number to correct for source power. If unspecified, value is set to 1.
- <data> Correction Data
- [src] **String.** (NOT case sensitive). Source port. Optional. Use [SOUR:CAT?](#) to return a list of valid port names.
While this argument can be used to make settings for ALL ports, it is designed to access ports that are not simple numbers, such as "Port 1 Src2". Otherwise, the <port> argument performs the same function. If both arguments are specified, [src] takes priority.

Examples `SOURce1:POWer2:CORRection:DATA:PRIor 0.12, -0.34, 0.56`

Query Syntax `SOURce<ch>:POWer<port>:CORRection:DATA:PRIor? [src]`

Return Type Depends on [FORMat:DATA](#) command

Default Not Applicable

[SOURce<ch>:POWer<port>:CORRection:LEVel\[:AMPLitude\] <num>\[,src\]](#)

Applicable Models: E5080A, M9485A

(Read-Write) Specifies the power level that is expected at the desired reference plane (DUT input or output). This is not used for [segment sweep with independent power levels](#) or [power sweeps](#).

Note: Although this command still works, it is recommended that you specify cal power by setting the [test port power](#) and [offset](#) value.

Parameters

- <ch> Channel number of the source power cal. If unspecified, value is set to 1
- <port> Port number to correct for source power. If unspecified, value is set to 1.
- <num> Cal power level in dBm. Because this could potentially be at the output of a

device-under-test, no limits are placed on this value here. It is realistically limited by the specifications of the device (power sensor) that will be used for measuring the power. The power delivered to the VNA receiver must never exceed VNA specifications for the receiver!

[src] **String**. (NOT case sensitive). Source port. Optional. Use [SOUR:CAT?](#) to return a list of valid port names.

While this argument can be used to make settings for ALL ports, it is designed to access ports that are not simple numbers, such as "Port 1 Src2". Otherwise, the <port> argument performs the same function. If both arguments are specified, [src] takes priority.

Examples

```
SOUR:POW:CORR:LEV 10
sourcel:power2:correction:level:amplitude 0 dbm
```

Query Syntax SOURce:POWer:CORRection:LEVel[:AMPLitude]? [src]

Return Type Numeric

Default 0 dBm

[SOURce<ch>:POWer<port>:CORRection:OFFSet\[:MAGNitude\] <num>\[,src\]](#)

Applicable Models: E5080A, M9485A

(Read-Write) Sets or returns a power level offset from the VNA test port power. This can be a gain or loss value (in dB) to account for components you connect between the source and the reference plane of your measurement. For example, specify 10 dB to account for a 10 dB amplifier at the input of your DUT.

Cal power is the sum of the test port power setting and this offset value. Following the calibration, the VNA power readouts are adjusted to the cal power.

Parameters

<ch> Channel number of the source power cal. If unspecified, value is set to 1

<port> Port number to correct for source power. If unspecified, value is set to 1.

<num> Gain or loss value in dB. Choose a value between -200 and 200

[src] **String**. (NOT case sensitive). Source port. Optional. Use [SOUR:CAT?](#) to return a list of valid port names.

While this argument can be used to make settings for ALL ports, it is designed to access ports that are not simple numbers, such as "Port 1 Src2". Otherwise, the <port> argument performs the same function. If both arguments are specified, [src] takes priority.

Examples

```
SOUR:POW:CORR:OFFS 10
sourcel:power2:correction:offset:magnitude -3
```

Query Syntax SOURce:POWer:CORRection:OFFSet[:MAGNitude]? [src]

Return Type Numeric

Default 0 dB

SOURce<ch>:POWER<port>:CORRection[:STATe] <bool>[,src]**Applicable Models:** E5080A, M9485A**(Read-Write)** Enables and disables source power correction for the specified port on the specified channel.**Parameters**

- <ch> Channel number of the source power cal. If unspecified, value is set to 1
- <port> Port number to correct for source power. If unspecified, value is set to 1.
- <bool> ON (or 1) turns source power correction ON.
OFF (or 0) - turns source power correction OFF.
- [src] **String.** (NOT case sensitive). Source port. Optional. Use [SOUR:CAT?](#) to return a list of valid port names.

While this argument can be used to make settings for ALL ports, it is designed to access ports that are not simple numbers, such as "Port 1 Src2". Otherwise, the <port> argument performs the same function. If both arguments are specified, [src] takes priority.

Examples

```
SOUR:POW:CORR ON
source1:power2:correction:state off
```

Query Syntax SOURce:POWer:CORRection[:STATe]? [src]**Return Type** Boolean (1 = ON, 0 = OFF)**Default** OFF (0)

Last Modified:

29-Sep-2015 First Release



Status Register Commands

The status registers enable you to query the state of selected events that occur in the analyzer.

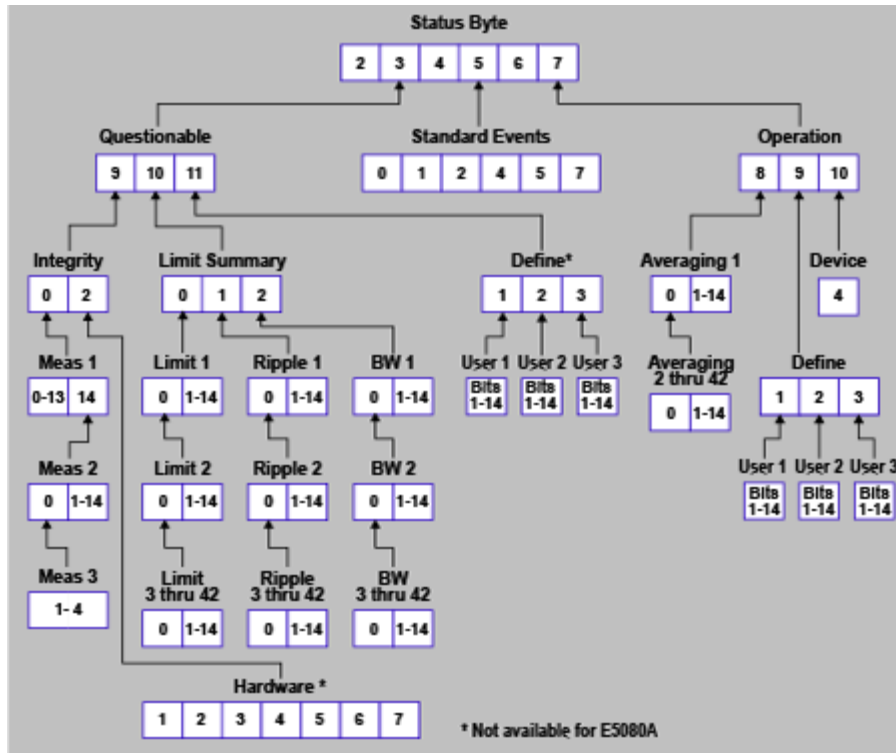

Note: This documentation requires familiarity with the "Standard Status Data Structure - Register Model" as defined in IEEE Std 488.2-1992. Also, first read [Learn about Status Registers](#)

STATus:

[OPERation](#)

| [AVERaging](#)

| [DEvice](#)

[PRESet](#)

[QUESTionable](#)

| [INTegrity](#)

| [MEASurement](#)

| [LSUMmary](#)

| [LIMit](#)

| [BLIMit](#)

| [RLIMit](#)

Click on a [Red](#) keyword to view the command details.

See Also

- Example Programs
- [Learn about Status Registers](#)
- [Synchronizing the VNA and Controller](#)
- [SCPI Command Tree](#)

Notes:

- Any bit not shown in the registers is not used but may be reserved for future use.
- The SCPIStringParser can NOT be used with SCPI Status Reporting. However, the *OPC? will work.

Status Byte Register

Applicable Models: E5080A, M9485A

Summarizes the states of the other registers and monitors the VNA output queue. It also generates **service requests**. The Enable register is called the Service Request Enable Register.

Commands	Description
*CLS	Clears ALL "event" registers and the SCPI Error / Event queue. The corresponding ENABLE registers are unaffected.
*STB?	Reads the value of the analyzer's status byte. The byte remains after being read.
*SRE?	Reads the current state of the Service Request Enable Register.
*SRE <num>	Sets bits in the Service Request Enable register. The current setting of the SRE register is stored in non-volatile memory. Use *SRE 0 to clear the enable. <num> Combined value of the weights for bits to be set.

Bit	Weight	Description	Bit is set to 1 when the following conditions exist:
2	4	Error / Event queue Summary (EAV)	the Error / Event queue is not empty. To read the error message, use SYST:ERR?
3	8	Questionable Register Summary	any enabled bit in the questionable event status register is set to 1
4	16	Message Available	the output queue is not empty
5	32	Standard Event Register Summary	any enabled bit in the standard event status register is set to 1
6	64	Request Service	any of the other bits in the status byte register is set to 1 (used to alert the controller of a service request within the analyzer). This bit cannot be disabled.
7	128	Operation Register Summary	any enabled bit in the standard operation event status register is set to 1

Standard Event Status Register

Applicable Models: E5080A, M9485A

Monitors "standard" events that occur in the analyzer. This register can only be cleared by:

- a Clear Command (*CLS).
- reading the Standard Enable Status Register (*ESE?).
- a power-on transition. The analyzer clears the register and then records any transitions that occur, including setting the Power On bit (7).

Commands	Description
*ESE?	Reads the settings of the standard event ENABLE register.
*ESE <bits>	Sets bits in the standard event ENABLE register. The current setting is saved in non-volatile memory. <bits> The sum of weighted bits in the register. Use *ESE 0 to clear the enable register.
*ESR?	Reads and clears the EVENT settings in the Standard Event Status register.
*OPC	Sets bit 0 when the overlapped command is complete. (see Understanding Command Synchronization / OPC).
*OPC?	Operation complete query - read the Operation Complete bit (0).

Bit	Weight	Description	Bit is set to 1 when the following conditions exist:
0	1	Operation Complete	the two following events occur in order : <ol style="list-style-type: none"> 1. the *OPC command is sent to the analyzer 2. the analyzer completes all pending overlapped commands
1	NA	Request Control	Not Supported - the analyzer application is not configured to control GPIB operation
2	4	Query Error	a query error is detected indicating: - an attempt to read data from the output queue when no data was present OR - data in the output queue was lost, as in an overflow
4	16	Execution Error	an execution error is detected indicating: - a <PROGRAM DATA> element was outside the legal range or inconsistent with the operation of the analyzer OR - the analyzer could not execute a valid command due to some internal condition
5	32	Command Error	a command error is detected indicating that the analyzer received a command that: <ul style="list-style-type: none"> • did not follow proper syntax • was misspelled

			<ul style="list-style-type: none"> was an optional command it does not implement
7	128	Power ON	Power to the analyzer has been turned OFF and then ON since the last time this register was read.

STATus:OPERation<keyword>

Applicable Models: E5080A, M9485A

Summarizes conditions in the Averaging and Operation:Define:User<1|2|3> event registers.

<keyword> Example

:CONDition? **STAT:OPER:COND?**

:ENABle <bits> **STAT:OPER:ENAB 1024**

[:EVENT]? **STAT:OPER?**

:NTRansition **STAT:OPER:NTR 1024**

<bits>

:PTRansition **STAT:OPER:PTR 0**

<bits>

Bit	Weight	Description	Bit is set to 1 when the following conditions exist:
8	256	Averaging summary	either enabled bit in the Averaging summary event register is set to 1
9	512	User Defined summary	
10	1024	Device summary	either enabled bit in the Device summary event register is set to 1

STATus:OPERation:AVERaging<n>:<keyword>

Applicable Models: E5080A, M9485A

Monitors and summarizes the status of Averaging on traces 1 to 580. When averaging for a trace is complete, the representative bit is set to 1.

Bit 0 is used to summarize the status in the registers that follow. For example, Average Register 3, bit 0, summarizes the status from registers 4 through 42.

All enable bits are set to 1 by default.

To find the measurement number, use [Calc:Par:Mnum](#).

<n> Averaging Register. Choose from 1 to 42

<keyword> Example

:CONDition? **STAT:OPER:AVER1:COND?**

:ENABle <bits> STAT:OPER:AVER1:ENAB 1024

[:EVENT]? STAT:OPER:AVER1?

:NTRansition
<bits> STAT:OPER:AVER1:NTR 1024:PTRansition
<bits> STAT:OPER:AVER1:PTR 0

		Averaging Register <n>											
Bit	Weight	1	2	3	4	5	6	7	8	...	41	42	Bit is set to 1 when the following conditions exist:
0	1	2-42	3-42	4-42	5-42	6-42	7-42	8-42	9-42	...	42	--	Summary Bit - If any bit from that register fails, it propagates to the previous register, bit 0.
		Trace Numbers											
1	2	1	15	29	43	57	71	85	99	...	561	575	Averaging on this trace is complete
2	4	2	16	30	44	58	72	86	100	...	562	576	Averaging on this trace is complete
3	8	3	17	31	45	59	73	87	101	...	563	577	Averaging on this trace is complete
4	16	4	18	32	46	60	74	88	102	...	564	578	Averaging on this trace is complete
5	32	5	19	33	47	61	75	89	103	...	565	579	Averaging on this trace is complete
6	64	6	20	34	48	62	76	90	104	...	566	580	Averaging on this trace is complete
7	128	7	21	35	49	63	77	91	105	...	567	--	Averaging on this trace is complete
8	256	8	22	36	50	64	78	92	106	...	568	--	Averaging on this trace is complete
9	512	9	23	37	51	65	79	93	107	...	569	--	Averaging on this trace is complete
10	1024	10	24	38	52	66	80	94	108	...	570	--	Averaging on this trace is

													complete
11	2048	11	25	39	53	67	81	95	109	...	571	--	Averaging on this trace is complete
12	4096	12	26	40	54	68	82	96	110	...	572	--	Averaging on this trace is complete
13	8192	13	27	41	55	69	83	97	111	...	573	--	Averaging on this trace is complete
14	16384	14	28	42	56	70	84	98	112	...	574	--	Averaging on this trace is complete

To determine Register, Bit number, and Weight for trace numbers between 113 and 560 (not shown in the above table) use the following calculations.

The averaging status for trace numbers higher than 580 can NOT be tracked.

The following example calculates the Register, Bit number, and Bit Weight for trace # 400:

- To determine **Register** number, use $((\text{Trace \#} - 1) / 14) + 1$.
- To determine **Bit Number**, use the **remainder** +1 of the above calculation.
- $((400-1)/14) + 1 = \text{Register\# } r+1\text{Bit}$
 - $399/14 = 28 \text{ r}7$
 - $28+1 = \text{Register } 29$
 - $7+1 = \text{Bit number } 8$
- To determine **Bit Weight**: Use above table. For example: Bit 8 = **256**



STATus:OPERation:DEvice<keyword>

Applicable Models: E5080A, M9485A

Summarizes conditions in the OPERation:DEvice event registers.

<keyword> Example

:CONDition? **STAT:OPER:DEV:COND?**

:ENABle <bits> **STAT:OPER:DEV:ENAB 16**

[:EVENT]? **STAT:OPER:DEV?**

:NTRansition
<bits> **STAT:OPER:DEV:NTR 16**

:PTRansition
<bits> **STAT:OPER:DEV:PTR 0**

Bit	Weight	Description	Bit is set to 1 when the following conditions exist:
0	1	Unused	
1	2	Unused	
2	4	Unused	
3	8	Unused	
4	16	Sweep Completed	When sweep is complete
5	32	Unused	
6	64	Unused	
7	128	Unused	
8	256	Unused	
9	512	Unused	
10	1024	Unused	
11	2048	Unused	
12	4096	Unused	
13	8192	Unused	
14	16384	Unused	

STATus:PRESet**Applicable Models:** E5080A, M9485A**(Write-only)** Initializes all the status registers.

Example

STAT:PRES**STATus:QUESTIONable:<keyword>****Applicable Models:** E5080A, M9485A

Summarizes conditions that monitor the quality of measurement data.

<keyword> Example

:CONDition? **STAT:QUES:COND?**:ENABle <bits> **STAT:QUES:ENAB 1024**[:EVENT] ? **STAT:QUES?**

:NTRansition <bits> **STAT:QUES:NTR 1024**

:PTRansition <bits> **STAT:QUES:PTR 0**

Bit	Weight	Description	Bit is set to 1 when the following conditions exist:
9	512	Integrity Reg summary	any enabled bit in the Integrity event register is set to 1
10	1024	Limit Registers summary	any enabled bit in the Limit event registers is set to 1
11	2048	Define Registers summary	any enabled bit in the Define event registers is set to 1

STATUS:QUESTIONABLE:INTEGRITY <keyword>

Applicable Models: E5080A, M9485A

Summarizes conditions in the Measurement Integrity register.

<keyword> Example

:CONDition? **STAT:QUES:INT:COND?**

:ENABle <bits> **STAT:QUES:INT:ENAB 1024**

[:EVENT]? **STAT:QUES:INT?**

:NTRansition <bits> **STAT:QUES:INT:NTR 1024**

:PTRansition <bits> **STAT:QUES:INT:PTR 0**

Bit	Weight	Description	Bit is set to 1 when the following conditions exist:
0	1	Measurement Summary	any bit in the Measurement Integrity event register is set to 1
2	4	Hardware Summary	any bit in the Hardware event register is set to 1

STATUS:QUESTIONABLE:INTEGRITY:MEASUREMENT <n> <keyword>

Applicable Models: E5080A, M9485A

Note: This register can be used ONLY with standard S-parameter measurements.

Monitors the lag between changing a channel setting and when the data is ready to query.

When you change the channel state (start/stop freq, bandwidth, and so forth), then the questionable bit for that channel is set. This indicates that your desired channel state does not yet match the data you would get if querying a data trace. When the next sweep is complete (without aborting in the middle), and the data trace matches the channel state that produced it, the bit is cleared for that channel.

<n> Measurement register number. Choose from 1 to 3

<keyword> Example

:CONDition? STAT:QUES:INT:MEAS1:COND?

:ENABLE <bits> STAT:QUES:INT:MEAS2:ENAB 1024

[:EVENT]? STAT:QUES:INT:MEAS3?

:NTRansition
<bits> STAT:QUES:INT:MEAS2:NTR 1024

:PTRansition
<bits> STAT:QUES:INT:MEAS1:PTR 0

		Measurement Register <n>			
Bit	Weight	1	2	3	Bit is set to 1 when the following conditions exist:
0	1	1	Summary from Meas Reg 3		a setting change on this channel has occurred and the data does not yet reflect that change.
1	2	2	15	29	a setting change on this channel has occurred and the data does not yet reflect that change.
2	4	3	16	30	a setting change on this channel has occurred and the data does not yet reflect that change.
3	8	4	17	31	a setting change on this channel has occurred and the data does not yet reflect that change.
4	16	5	18	32	a setting change on this channel has occurred and the data does not yet reflect that change.
5	32	6	19		a setting change on this channel has occurred and the data does not yet reflect that change.
6	64	7	20		a setting change on this channel has occurred and the data does not yet reflect that change.
7	128	8	21		a setting change on this channel has occurred and the data does not yet reflect that change.

8	256	9	22		a setting change on this channel has occurred and the data does not yet reflect that change.
9	512	10	23		a setting change on this channel has occurred and the data does not yet reflect that change.
10	1024	11	24		a setting change on this channel has occurred and the data does not yet reflect that change.
11	2048	12	25		a setting change on this channel has occurred and the data does not yet reflect that change.
12	4096	13	26		a setting change on this channel has occurred and the data does not yet reflect that change.
13	8192	14	27		a setting change on this channel has occurred and the data does not yet reflect that change.
14	16384	Summary from Meas Reg 2	28		a setting change on this channel has occurred and the data does not yet reflect that change.

STATus:QUESTIONable:LSUMmary:<keyword>

Applicable Models: E5080A, M9485A

Summary register of limit test, ripple test and bandwidth test. bit 0: summary bit for the limit test. bit 1: summary bit for the ripple limit test. bit 2: summary bit for the bandwidth limit test.

<keyword> Example

:CONDition? **STAT:QUES:LSUM:COND?**

:ENABLE <bits> **STAT:QUES:LSUM:ENAB 8**

[:EVENT]? **STAT:QUES:LSUM?**

:NTRansition
<bits> **STAT:QUES:LSUM:NTR 8**

:PTRansition
<bits> **STAT:QUES:LSUM:PTR 0**

STATus:QUESTIONable:LSUMmary:BLIMit <n>:<keyword>

Applicable Models: E5080A, M9485A

Monitors and summarizes the status of ripple limit line failures. When a trace fails, the representative bit is set to 1.

Bit 0 is used to summarize failures in the registers that follow. Refer the STATus:QUESTIONable:LSUMmary:LIMit for the trace number information.

All enable bits are set to 1 by default.

To find the measurement number, use [Calc:Par:Mnum](#)

<n> Bandwidth Limit register. Choose from 1 to 42..

<keyword> Example

:CONDition?	STAT:QUES:LSUM:BLIM:COND?
:ENABle <bits>	STAT:QUES:LSUM:BLIM:ENAB 1024
[:EVENT]?	STAT:QUES:LSUM:BLIM?
:NTRansition <bits>	STAT:QUES:LSUM:BLIM:NTR 1024
:PTRansition <bits>	STAT:QUES:LSUM:BLIM:PTR 0

STATus:QUEStionable:LSUMmary:LIMit<n>: <keyword>

Applicable Models: E5080A, M9485A

Monitors and summarizes the status of limit line failures. When a trace fails, the representative bit is set to 1.

Bit 0 is used to summarize failures in the registers that follow. For example, Limit Register 3, bit 0, summarizes the failures from registers 4 through 42.

All enable bits are set to 1 by default.

To find the measurement number, use [Calc:Par:Mnum](#)

<n> Limit register. Choose from 1 to 42.

<keyword> Example

:CONDition?	STAT:QUES:LSUM:LIM4:COND?
:ENABle <bits>	STAT:QUES:LSUM:LIM1:ENAB 1024
[:EVENT]?	STAT:QUES:LSUM:LIM3?
:NTRansition <bits>	STAT:QUES:LSUM:LIM2:NTR 1024
:NTRansition?	STAT:QUES:LSUM:LIM1:NTR?
:PTRansition <bits>	STAT:QUES:LSUM:LIM5:PTR 0
:PTRansition?	STAT:QUES:LSUM:LIM1:PTR?

		Limit Register <n>											
Bit	Weight	1	2	3	4	5	6	7	8	...	41	42	Bit is set to 1 when the following conditions exist:

0	1	2-42	3-42	4-42	5-42	6-42	7-42	8-42	9-42	...	42	--	Summary Bit - If any bit from that register fails, it propagates to the previous register, bit 0.
Trace Numbers													
1	2	1	15	29	43	57	71	85	99	...	561	575	any point on trace fails the limit test
2	4	2	16	30	44	58	72	86	100	...	562	576	any point on trace fails the limit test
3	8	3	17	31	45	59	73	87	101	...	563	577	any point on trace fails the limit test
4	16	4	18	32	46	60	74	88	102	...	564	578	any point on trace fails the limit test
5	32	5	19	33	47	61	75	89	103	...	565	579	any point on trace fails the limit test
6	64	6	20	34	48	62	76	90	104	...	566	580	any point on trace fails the limit test
7	128	7	21	35	49	63	77	91	105	...	567	--	any point on trace fails the limit test
8	256	8	22	36	50	64	78	92	106	...	568	--	any point on trace fails the limit test
9	512	9	23	37	51	65	79	93	107	...	569	--	any point on trace fails the limit test
10	1024	10	24	38	52	66	80	94	108	...	570	--	any point on trace fails the limit test
11	2048	11	25	39	53	67	81	95	109	...	571	--	any point on trace fails the limit test
12	4096	12	26	40	54	68	82	96	110	...	572	--	any point on trace fails the limit test
13	8192	13	27	41	55	69	83	97	111	...	573	--	any point on trace fails the limit test
14	16384	14	28	42	56	70	84	98	112	...	574	--	any point on trace fails the limit test

To determine Register, Bit number, and Weight for trace numbers between 113 and 560 (not shown in the above table) use the following calculations.

The limit status for trace numbers higher than 580 can NOT be tracked.

The following example calculates the Register, Bit number, and Bit Weight for trace # 400:

- To determine Limit **Register** number, use $((\text{Trace \#} - 1) / 14) + 1$.

- To determine Limit **Bit Number**, use the **remainder +1** of the above calculation.
- $((400-1)/14) + 1 = \text{Register\# r+1Bit}$
 - $399/14 = 28 \text{ r}7$
 - $28+1 = \text{Register } 29$
 - $7+1 = \text{Bit number } 8$
- To determine Limit **Bit Weight**: Use above table. For example: Bit 8 = **256**

STATus:QUEStionable:LSUMmary:RLIMit <cnum>:<keyword>

Applicable Models: E5080A, M9485A

Monitors and summarizes the status of ripple limit line failures. When a trace fails, the representative bit is set to 1.

Bit 0 is used to summarize failures in the registers that follow. Refer the STATus:QUEStionable:LSUMmary:LIMit for the trace number information.

All enable bits are set to 1 by default.

To find the measurement number, use [Calc:Par:Mnum](#)

<n> Ripple limit channel status register. Choose from 1 to 42.

<keyword> Example

:CONDition?	STAT:QUES:LSUM:RLIM:COND?
:ENABle <bits>	STAT:QUES:LSUM:RLIM:ENAB 1024
[:EVENT]?	STAT:QUES:LSUM:RLIM?
:NTRansition <bits>	STAT:QUES:LSUM:RLIM:NTR 1024
:PTRansition <bits>	STAT:QUES:LSUM:RLIM:PTR 0

Last modified:

29-Sep-2015 First Release

System
System Commands

Controls and queries settings that affect the VNA system.

SYSTEM:
ABORt:THReshold
ACTive
 | **CHANnel**
 | **MEASurement**
BEEPer:VOLume
BEEP:STAT
CAL:ALL **More commands**
CHANnels
 | **CATalog?**
 | **COUPle[:STATe]**
 | **COUPle:GROUp**
 | **COUPle:PARallel[:ENABle]**
 | **COUPle:PARallel:STATe**
 | **DELete**
 | **HOLD**
 | **RESume**
CLOCK[:STATe]
COMMunicate **More commands**
CONFigure
 | **DIRectory**

CONFigure:EDEVice **More commands**
CORRection
 | **INTerpolate:LINEar** **More commands**
 | **WIZard[:IMMediate]**
ERRor?
 | **COUNT?**
 | **REPort**
 | **SUNLeveled**
FCORrection:CHANnel:COUPler[:STATe]
FPReset
ISPControl[:STATe]
MACRO:COPI
 | **CHANnel[:TO]**
 | **CHANnel:STATe**
 | **SOURce**
MCLass
 | **CATalog?**
 | **PARAmeter:CATalog?**
MEASurement
 | **CATalog?**
 | **NAME?**
 | **TRACe?**
 | **WINDow?**

POFF
POWer:
LIMit
LOCK
STATe
PREferences More commands
PRESet
SECurity
[LEVel]
SET
SHORtcut
ARGuments
DELete
EXECute
PATH
TITLe
TOUCHscreen[:STATe]
UPReset
FPANel[:STATe]
LOAD[:FILE]
SAVE[:STATe]
WINDows
CATalog?

Click on a **Red** keyword to view the command details.

See Also

- [Referring to Traces Channels Windows and Meas Using SCPI](#)
- Learn about VNA Preferences
- Example Programs
- [Synchronizing the VNA and Controller](#)
- [SCPI Command Tree](#)

SYSTem:ABORt:THReshold <value>

Applicable Models: E5080A, M9485A

(Read-Write) When a VNA setting is made while a sweep is in progress, the sweep is immediately aborted by default. This command allows you to change that behavior by specifying a time threshold. When a setting change is made during a sweep and if the total sweep time is less than the threshold time, then the sweep is allowed to finish instead of immediately aborting.

In general, VNA setting changes that could cause an aborted sweep are changes that affect how a measurement is made, such as changes in stimulus conditions.

For example, with a threshold setting of 60 seconds:

- Sweeps that require 60 seconds or less from start to finish will be allowed to complete if a VNA setting change is made at any time during the sweep.
- Sweeps that require MORE than 60 seconds from start to finish will be immediately aborted when

a VNA setting change is made at any time during the sweep.

Notes:

- Preset clears this setting.
- Save state saves this setting.
- Sweep times are estimated.
- This setting affects ALL channels.

Parameters

<value> Threshold time in seconds. Set to 0 to immediately abort a sweep when a VNA setting is made.

Examples

```
SYST:ABOR:THR 10
```

```
'When a setting is made during a sweep, if that sweep
requires less than 10 seconds more to complete, it will be
allowed to finish instead of aborting.'
```

Query Syntax SYSTem:ABORT:THReshold?

Default 0 - No threshold time; all sweeps are immediately aborted.

SYSTem:ACTive:CHANnel?

Applicable Models: E5080A, M9485A

(Read-only) Returns the number of the active channel. The active channel is the channel number that contains the active measurement. The active measurement is the trace that has a highlighted **Tr#** in the [Trace Status](#) area.

If there is no active channel, 0 is returned.

Examples

```
SYST:PRES
SYST:ACT:CHAN?
'Returns 1
```

Return Type Integer

Default Not Applicable

SYSTem:ACTive:MEASurement?

Applicable Models: E5080A, M9485A

(Read-only) Returns the name of the active measurement. While looking at the VNA display, the active measurement is the trace that has a highlighted **Tr#** in the [Trace Status](#) area. Only displayed

measurements can be active.

If there is no active measurement, " " (empty string) is returned.

Examples

```

SYST:PRES
SYST:ACT:MEAS?

>Returns "CH1_s11_1"

```

Return Type String

Default Not Applicable

SYSTem:BEEPer:VOLume <num>

Applicable Models: M9485A

(Read-Write) Sets and reads the volume of the internal speaker.

Parameters

<num> Relative volume of the internal speaker.
Choose a volume between 0 (off) and 100.

Examples

```

SYST:BEEP:VOL 5
system:beeper:volume

```

Query Syntax SYSTem:BEEPer:VOLume?

Default 0

SYSTem:BEEPer:STATus <num>

Applicable Models: E5080A, M9485A

(Read-Write) Sets the beeper on or off.

Parameters

<num> Set the beeper volume on (1) or off (0).

Examples

```

SYST:BEEP:STAT 1

```

Query Syntax SYSTem:BEEPer:STAT?

Default 0

SYSTem:CHANnels:CATalog?**Applicable Models:** E5080A, M9485A**(Read-only)** Returns the channel numbers currently in use.

Examples

```

SYST:CHAN:CAT?
system:channels:catalog?
>Returns:
"1,2,3"

```

Return Type String of comma-separated numbers**Default** Not Applicable**SYSTem:CHANnels:COUPle[:STATe] <bool>****Applicable Models:** E5080A, M9485A**(Read-Write)** Sets and reads the state of channel coupling.

When set to ON, all existing S-parameter channels receive the stimulus settings of the active channel. Subsequent changes made to any coupled channel are changed on all coupled channels.

Channels with applications such as SMC are not affected.

Coupling is primarily aimed at stimulus settings (such as start, stop, points, power) but also applies to many trigger settings and to Cal Set pointers.

Parameters

<bool> **ON** (or 1) Channels are coupled
OFF (or 0) Channels are NOT coupled

Examples

```

SYST:CHAN:COUP 1
system:channels:couple:state OFF

```

Query Syntax SYSTem:CHANnels:COUPle[:STATe]?**Default** OFF**SYSTem:CHANnels:COUPle:GROUp <array>****Applicable Models:** M9485A**(Read-Write)** Sets and reads the group of channel for the mult-DUT parallel measurement.

Parameters

<array> {<number of group>, <start channel No.>, <end channel No.>, ... }

The first item means number or groups.

Next pairs show start/end channel numbers of the group. 1 pair for 1 group.

Example:

{0} Global coupling (default setting)

{1, 1,4} Couples channel 1-4

{2, 1,3, 5,7} Couples channel 1-3 and 5-7 independently

Examples

```
SYST:CHAN:COUP:GROU 2,1,3,5,7
```

```
system:channels:couple:group 1,1,4
```

Query Syntax SYSTem:CHANnels:COUPle[:GROUp?]

Default 0

SYSTem:CHANnels:COUPle:PARAllel[:ENABle] <bool>

Applicable Models: M9485A

(Read-Write) Sets and reads the Multi DUT parallel measurement state. SYST:CHAN:COUP should be also turned on when Multi DUT parallel measurement is performed.

Parameters

<bool> **ON** (or 1) Multi DUT parallel measurement are enabled

OFF (or 0) Multi DUT parallel measurement are NOT enabled

Examples

```
SYST:CHAN:COUP:PAR 1
```

```
system:channels:couple:parallel OFF
```

Query Syntax SYSTem:CHANnels:COUPle:PARAllel[:ENABle]?

Default OFF

SYSTem:CHANnels:COUPle:PARAllel:STATe? <value>

Applicable Models: M9485A

(Read Only) Gets the information if the parallel measurement is executed in the last sweep, for the targeted channel..

Parameters

<value> Channel number

Examples `SYST:CHAN:COUP:PAR:STAT? 1`
`system:channels:couple:parallel:state? 2`

Query Syntax `SYSTem:CHANnels:COUPle:PARAllel:STATe?`

Default Not Applicable

SYSTem:CHANnels:DELeTe <value>

Applicable Models: E5080A, M9485A

(Write-only) Deletes the specified channel.

Parameters

<value> Channel number to delete

Examples `SYST:CHAN:DEL 2`

Query Syntax Not Applicable

Default Not Applicable

SYSTem:CHANnels:HOLD

Applicable Models: E5080A, M9485A

(Write-only) Places all channels in hold mode. To place a single channel in hold mode, use [SENS:SWE:MODE](#).

Examples `SYST:CHAN:HOLD`

Query Syntax Not Applicable

Default Not Applicable

SYSTem:CHANnels:RESume

Applicable Models: E5080A, M9485A

(Write-only) Resumes the trigger mode of all channels that was in effect before sending [SYSTem:CHANnels:HOLD](#) (must be sent before `SYST:CHAN:RESume`).

Examples `SYST:CHAN:RES`

Query Syntax Not Applicable

Default Not Applicable

SYSTEM:CLOCK[:STATE] <bool>

Applicable Models: E5080A, M9485A

(Read-Write) Sets and reads the clock visibility state in the VNA status bar.

Parameters

<bool> **ON** (or 1) Clock is visible in the VNA status bar.
OFF (or 0) Clock is NOT visible in the VNA status bar.

Examples `SYST:CLOC 1`
`system:clock:state OFF`

Query Syntax `SYSTEM:CLOCK[:STATE]?`

Default ON

SYSTEM:CONFigure:DIRectory? <char>

Applicable Models: E5080A, M9485A

(Read-only) Returns the directory path location for the specified file type.

Parameters None

<char> Type of file. Choose from:

STATE - This is the location for the storage of state files

- On Windows XP, this returns: "c:\program files\Keysight\network analyzer\documents"
- On Windows 7, this returns: "c:\users\public\documents\network analyzer"

APPLICATION - This is the location of the VNA firmware executable files

- On Windows XP, this returns: "c:\program files\Keysight\network analyzer"
- On Windows 7, this returns: "c:\program files (x86)\Keysight\network analyzer"

SUPPORT - This is the location of private support files for the VNA firmware

- On Windows XP, this returns: "c:\program files\Keysight\network

analyzer"

- On Windows 7, this returns: "c:\programdata\Keysight\network analyzer"

Example `SYST:CONF:DIR? SUPP`

Return Type String

Default Not applicable

SYSTEM:CORREction:WIZard[:IMMediate] <char>

Applicable Models: E5080A, M9485A

(Write-only) Launches either the Calibration Wizard or the Version 2 Calibration Kit File Manager dialog box.

Remote operation returns immediately after the dialog is launched. This is done to avoid timeout issues with I/O protocols such as VISA. Although it is possible to send commands to the VNA while the dialog is open, this is not encouraged. Application programs should wait until the dialog is closed before resuming remote operations.

Parameters

<char> Choose from:

MAIN - Launches the Calibration Wizard which matches the current channel, such as standard S-params, NoiseFigure, GCA, and so forth.

CKIT - Launches the Version 2 Calibration Kit File Manager dialog box.

Both display on the VNA screen.

Examples `SYST:CORR:WIZ MAIN`
`system:correction:wizard:immediate ckit`

Query Syntax Not Applicable

Default Not Applicable

SYSTEM:ERRor?

Applicable Models: E5080A, M9485A

(Read-only) Returns the next error in the error queue. Each time the analyzer detects an error, it places a message in the error queue. When the `SYSTEM:ERROR?` query is sent, one message is moved from the error queue to the output queue so it can be read by the controller. Error messages are delivered to the output queue in the order they were received. The error queue is cleared when any of the following conditions occur:

- When the analyzer is switched ON.

- When the *CLS command is sent to the analyzer.
- When all of the errors are read.

If the error queue overflows, the last error is replaced with a "Queue Overflow" error. The oldest errors remain in the queue and the most recent error is discarded.

[See list of all SCPI Errors.](#)

Examples `SYST:ERR?`
`system:error?`

Default Not Applicable

SYSTem:ERRor:COUNT?

Applicable Models: E5080A, M9485A

(Read-only) Returns the number of errors in the error queue. Use SYST:ERR? to read an error.

[See list of all SCPI Errors.](#)

Examples `SYST:ERR:COUN?`
`system:error:count?`

Default Not Applicable

SYSTem:ERRor:REPort:SUNLeveled <bool>

Applicable Models: E5080A, M9485A

(Read-Write) Specifies whether or not to report [Source Unleveled](#) errors to the SCPI system error buffer. This setting will revert to the default (OFF) setting on Instrument Preset.

Parameters

<bool> **ON** (or 1) Report Source Unleveled Errors. Read errors from the system error buffer using [SYST:ERR?](#)
OFF (or 0) Do NOT report Source Unleveled Errors.

Examples `SYST:ERR:REP:SUNL 1`
`system:error:report:sunleveled ON`

Query Syntax SYSTem:ERRor:REPort:UNLeveled?

Default OFF

SYSTem:FCORrection:CHANnel<cnum>:COUPler[:STATe] <char>

Applicable Models: E5080A, M9485A

(Read-Write) Sets and returns the coupler state. This command is not effective for SMC class.

[Learn more about security level.](#)

Parameters

<char> Choose from:

OFF

AUTO

Examples

```
SYST:FCOR:CHAN:COUP AUTO
system:fcORrection:channel1:coupler OFF
```

Query Syntax SYSTem:FCORrection:CHANnel<num>:COUPler[:STATe]?

Return Type Character

Default AUTO

SYSTem:FPRreset

Applicable Models: E5080A, M9485A

(Write-only) Performs a standard [Preset](#), then deletes the default trace, measurement, and window. The VNA screen becomes blank.

Examples

```
SYST:FPR
system:fpreset
```

Default Not applicable

SYSTem:ISPControl[:STATe] <bool>

Applicable Models: E5080A, M9485A

(Read-Write) Sets and reads turns ON/OFF or returns the status of the Initial Source Port Control feature (to switch the stimulus output in the trigger hold state to a test port).

Variable

Parameters

<bool> **ON** (or 1) Source is outputted only when measurement is done .Source is not outputted during hold state.

OFF (or 0) Source is always outputted.

Examples

```
SYST:ISPC 1
```

```
system:ispcontrol OFF
```

Query Syntax SYSTem:ISPControl[:STATe]?

Default ON

SYSTem:MACRo:COPIY:CHANnel<cnum>[:TO] <num>

Applicable Models: E5080A, M9485A

(Write-only) Copies ALL settings from <cnum> channel to <num> channel. Learn more about [copy channels](#).

Use SENS:PATH:CONF:COPIY to copy ONLY mechanical switch and attenuator settings.

Parameters

<cnum> Channel number to copy settings from. If unspecified, value is set to 1.

<num> Channel number to copy settings to.

Examples

```
SYST:MACR:COPIY:CHAN1 2
system:macro:copy:channel2:to 3
```

Query Syntax Not Applicable

Default Not Applicable

SYSTem:MACRo:COPIY:CHANnel<fromChannel>:STATe <toChannel>,<toWindow>,[<copyScope>]

Applicable Models: E5080A, M9485A

(Write-only) Copies settings only, or settings and measurements, traces, markers, and limit lines from an existing channel, <fromChannel>, to a new channel, <toChannel>. Traces can be copied into the Active Window, a user specified window, or a new (next available) window. .

Parameters

<fromChannel> Channel number to copy settings from. If unspecified, value is 1.

<toChannel> 0 for next available channel, or N for channel number to copy settings to.

<toWindow> -1 will create a new window, 0 will use the active window, and N will use the specified window N. <toWindow> is ignored when <copyScope> is "stimulus"

<copyScope> must be "stimulus" which copies only settings, or "state" which copies settings, measurements, traces, markers, and limit lines.

Examples

```
SYST:MACR:COPIY:CHAN1:STAT 2,0,"stimulus"
```

Copies only settings from channel #1 to channel #2. This is equivalent to `SYST:MACR:COPY:CHAN1 2`

```
SYST:MACR:COPY:CHAN1:STAT 2,-1,"state"
```

Copies settings, measurements, traces, etc. from channel #1 to channel #2. Traces are placed into a new window (next available window), and additional windows will be created as necessary so that all traces are copied.

```
SYST:MACR:COPY:CHAN1:STAT 0,-1
```

Copies settings, measurements, etc. from channel #1 to the next available channel and places traces into the next available new window.

Query Syntax Not Applicable

Default Not Applicable

SYSTEM:MACRO:COPY:CHANNEL<fromChan>:SOURCE <fromPort>,<toChan>,<toPort>

Applicable Models: E5080A, M9485A

(Write-only) Copies and applies an existing Source Power Calibration to another channel. Learn more about [source power calibration](#).

Parameters

- <fromChan> Channel number of the existing source power correction.
- <fromPort> Port number of the existing source power correction.
- <toChan> Channel number to which the source power correction will be copied.
- <toPort> Port number to which the source power correction will be applied.

Examples

```
SYST:MACR:COPY:CHAN1:SOUR 1,2,1
system:macro:copy:channel2:source 2,1,2
```

Query Syntax Not Applicable

Default Not Applicable

SYSTEM:MCLASS:CATALOG?

Applicable Models: E5080A, M9485A

(Read-only) Returns measurement classes available on the VNA. [Learn more about Measurement Classes.](#)

Parameters None

Examples `SYST:MClass:CAT?`

Return Type String of comma-separated measurement class names. See the complete list of measurement class names.

Default Not Applicable

SYSTem:MClass:PARAmeter:CATalog? <name>

Applicable Models: E5080A, M9485A

(Read-only) Returns ALL parameters that are supported by the specified measurement class.

Parameters

<name> String. Measurement Class name. See the complete list of measurement class names.

Examples `'Returns all parameters for Gain Compression.'`

`SYST:MCL:PAR:CAT? "Gain Compression"`

Return:

`"S11,S12,S13,S14,S21,S22,S23,S24,S31,S32,S33,S34,S41,S42,S43,S44,A,B,C,D,R,R1,R2"`

Return Type String of comma-separated parameters

Default Not Applicable

SYSTem:MEASurement:CATalog? [chan]

Applicable Models: E5080A, M9485A

(Read-only) Returns ALL measurement numbers, or measurement numbers from a specified channel.

Parameters

[chan] Optional. Channel number to catalog. If not specified, all measurement numbers are returned.

Examples `'Returns all measurement numbers'`

`SYST:MEAS:CAT?`

`'Returns the measurement numbers on channel 2'`

```
system:measurement:catalog? 2
```

Return Type String of comma-separated numbers
For example: "1,2"

Default Not Applicable

SYSTem:MEASurement<n>:NAME?

Applicable Models: E5080A, M9485A

(Read-only) Returns the name of the specified measurement.

Parameters

<n> Measurement number for which to return the measurement name. If unspecified, value is set to 1.

Examples 'Returns the name of measurement 2
SYST:MEAS2:NAME?

Return Type String

Default Not Applicable

SYSTem:MEASurement<n>:TRACe?

Applicable Models: E5080A, M9485A

(Read-only) Returns the trace number of the specified measurement number. Trace numbers restart for each window while measurement numbers are always unique.

Parameters

<n> Measurement number for which to return the trace number. If unspecified, value is set to 1.

Examples 'Returns the trace number of measurement 1
SYST:MEAS1:TRAC?

Return Type Numeric

Default Not Applicable

SYSTem:MEASurement<n>:WINDow?

Applicable Models: E5080A, M9485A

(Read-only) Returns the window number of the specified measurement number.

Parameters

<n> Measurement number for which to return the window number. If unspecified, value is set to 1.

Examples `'Returns the window number of measurement 2
SYST:MEAS2:WIND?`

Return Type Numeric

Default Not Applicable

SYSTEM:POFF

Applicable Models: E5080A, M9485A

(Write-only) Shuts down the system.

Parameters

<n> Shutdown or restart. Choose from:
1 - Restart.
0 - Shutdown .

Examples `'Shuts down the system
SYST:POFF`

Default 0 (Shutdown)

SYSTEM:POWER<pnum>:LIMit <value>

Applicable Models: E5080A, M9485A

(Read-Write) Sets and returns the power limit for the specified port. [Learn more about Power Limit.](#)

Parameters

<pnum> Port number. Choose any VNA port.

<value> Power limit in dBm

Examples `SYST:POW1:LIM 5
system:power2:limit 0`

Query Syntax SYSTem:POWer<pnum>:LIMit?

Return Type Numeric

Default 100 dBm

SYSTem:POWer:LIMit:LOCK <bool>

Applicable Models: E5080A, M9485A

(Read-Write) Enables or disables the ability to change the power limit values through the user interface. [Learn more about Power Limit.](#)

Parameters

<bool> Power limit lock. Choose from:
ON or 1 - Enables the ability to change the power limit values from the user interface.
OFF or 0 - Disables the ability to change the power limit values from the user interface.

Examples

```
SYST:POW:LIM:LOCK 1
system:power:limit:lock OFF
```

Query Syntax SYSTem:POWer:LIMit:LOCK?

Return Type Boolean

Default OFF

SYSTem:POWer<pnum>:LIMit:STATE <bool>

Applicable Models: E5080A, M9485A

(Read-Write) Enables or disables the power limit for the specified port. [Learn more about Power Limit.](#)

Parameters

<pnum> Port number. Choose any VNA port.
 <value> Power limit state. Choose from:
ON or 1 Enables the power limit for the port<pnum>.
OFF or 0 Disables the power limit for the port<pnum>.

Examples

```
SYST:POW1:LIM:STAT ON
```

```
system:power2:limit:state 0
```

Query Syntax SYSTem:POWer<pnum>:LIMit:STATE?

Return Type Boolean

Default OFF

SYSTem:PRESet

Applicable Models: E5080A, M9485A

(Write-only) Deletes all traces, measurements, and windows. In addition, resets the analyzer to factory defined default settings and creates a S11 measurement named "CH1_S11_1". For a list of default settings, see [Preset](#).

Regardless of the state of the User Preset Enable checkbox, the SYST:PRESet command will always preset the VNA to the factory preset settings, and [SYST:UPReset](#) will always perform a User Preset.

If the VNA display is disabled with [DISP:ENAB OFF](#) then SYST:PRESet will NOT enable the display.

This command performs the same function as [*RST](#) with one exception: Syst:Preset does NOT reset [Calc:FORMAT](#) to ASCII as does *RST.

Examples

```
SYST:PRESet
system:presSet
```

Default Not applicable

SYSTem:SECurity[:LEVel] <char>

Applicable Models: E5080A, M9485A

(Read-Write) Sets and returns the display of frequency information on the VNA screen and printouts.

[Learn more about security level.](#)

Parameters

<char> Choose from:

NONE - ALL frequency information is displayed.

LOW - NO frequency information is displayed. Frequency information can be redisplayed using the Security Setting dialog box or this command.

HIGH - LOW setting plus [GPIB console](#) is disabled. Frequency information can be redisplayed ONLY by performing a Preset, recalling an instrument state with None or Low security settings, or using this command.

EXTRa - HIGH setting plus:

- [ASCII data saving](#) is disabled. Same method to redisplay frequency information as HIGH setting.

- Mixer setup files (*.mxr) can NOT be saved.

Examples `SYST:SEC LOW`
`system:security:level high`

Query Syntax `SYSTem:SECurity[:LEVel]?`

Return Type Character

Default None

SYSTem:SET <block>

Applicable Models: E5080A, M9485A

(Read-Write) Sends a definite-length binary block Instrument state and sets the VNA with those settings. This command does the same as saving a *.sta file to the VNA ([MMEM:STOR STATE](#)) and then [MMEM:TRAN](#) to transfer the file to the computer.

Parameters

<block> The Instrument state file as definite-length arbitrary binary block.

Examples `SYST:SET <block>`

Query Syntax `SYSTem:SET?` (This saves the instrument state file to the remote computer.)

Return Type Definite-length arbitrary binary block.

Default Not Applicable

SYSTem:SHORtcut<n>:ARGuments<string>

Applicable Models: M9485A

(Read-Write) Reads and writes the arguments for the specified macro. On the [Edit Macro Dialog](#), this is called the "Macro run string parameters".

Parameters

<n> Numeric. Number of the macro that is stored in the VNA.
 To find the number of a macro, either open the [Macro Setup dialog](#) and count the line number of the desired macro, or query the titles of all of the macros for the desired macro title.

<string> Arguments for the specified macro.

Examples `SYST:SHOR1:ARG`
`"http://na.tm.Keysight.com/pna/help/PNAWebHelp/help.htm"`

Query Syntax `SYSTem:SHORTcut<n>:ARGuments?`

Default Not Applicable

SYSTem:SHORTcut<n>:DELeTe

Applicable Models: M9485A

(Write-only) Removes the specified macro from the list of macros in the VNA. Does not delete the macro executable file.

Parameters

<n> Numeric. Number of the macro that is stored in the VNA.
 To find the number of a macro, either open the [Macro Setup dialog](#) and count the line number of the desired macro, or query the titles of all of the macros for the desired macro title.

Examples `SYST:SHOR1:DEL`

Query Syntax Not Applicable

Default Not Applicable

SYSTem:SHORTcut<n>:EXECute

Applicable Models: M9485A

(Write-only) Executes (runs) the specified Macro (shortcut) that is stored in the VNA.

Parameters

<n> Numeric. Number of the macro that is stored in the VNA.
 To find the number of a macro, either open the [Macro Setup dialog](#) and count the line number of the desired macro, or query the titles of all of the macros for the desired macro title.

Examples `SYST:SHOR1:EXEC`

Query Syntax Not Applicable

Default Not Applicable

SYSTem:SHORTcut<n>:PATH <string>

Applicable Models: M9485A

(Read-Write) Defines a Macro (shortcut) by linking a path and file name to the Macro number. To be executed, the executable file must be put in the VNA at the location indicated by this command.

Parameters

- <n> Numeric. Number of the macro to be stored in the analyzer. If the index number already exists, the existing macro is replaced with the new macro.
- <string> Full path, file name, and extension, of the existing macro "executable" file.
To find the number of a macro, either open the [Macro Setup dialog](#) and count the line number of the desired macro, or query the titles of all of the macros for the desired macro title.

Examples `SYST:SHOR1:PATH "C:/Program Files/Keysight/Network Analyzer/Documents/unguideMultiple.vbs"`

Query Syntax SYSTem:SHORTcut<n>:PATH?

Default Not Applicable

SYSTem:SHORTcut<n>:TITLe<string>

Applicable Models: M9485A

(Read-Write) Reads and writes the name of the specified macro.

Parameters

- <n> Numeric. Number of the macro that is stored in the VNA.
To find the number of a macro, either open the [Macro Setup dialog](#) and count the line number of the desired macro, or query the titles of all of the macros for the desired macro title.
- <string> The name to be assigned to the macro.

Examples `SYST:SHOR1:TITL "Guided 4-Port Cal"`

Query Syntax SYSTem:SHORTcut<n>:TITLe?

Default Not Applicable

SYSTem:TOUCHscreen[:STATe] <bool>**Applicable Models:** E5080A**(Read-Write)** Enables and disables the **PNA-X** touchscreen.

This setting remains until changed again from the front-panel or remotely, or until the hard drive is changed or reformatted.

Parameters

<bool> Choose from:
ON (1) Enables the touchscreen.
OFF (0) Disables the touchscreen.

Examples `SYST:TOUC 1`
`system:touchscreen:state OFF`

Query Syntax SYSTem:TOUCHscreen[:STATe]?**Return Type** Boolean**Default** **ON** when shipped from factory.**SYSTem:UPReset****Applicable Models:** E5080A, M9485A**(Write-only)** Performs a User Preset. There must be an active User Preset state file (see [Load](#) and [Save](#)) or an error will be returned. [Learn more about User Preset.](#)

Regardless of the state of the User Preset Enable checkbox, the SYST:PRESet command will always preset the VNA to the factory preset settings, and [SYST:UPReset](#) will always perform a User Preset.

Examples `SYST:UPReset`
`system:upreset`

Query Syntax Not Applicable**Default** Not Applicable**SYSTem:UPReset:FPANel[:STATe] <bool>****Applicable Models:** E5080A, M9485A**(Read-Write)** 'Checks' and 'clears' the enable box on the [User Preset dialog box](#). This only affects subsequent Presets from the front panel user interface.

Regardless of the state of the User Preset Enable checkbox, the [SYST:PRESet](#) command will always

preset the VNA to the factory preset settings, and [SYST:UPReset](#) will always perform a User Preset.

Parameters

<bool> Front Panel User Preset State. Choose from:
0 User Preset OFF
1 User Preset ON

Examples

```
SYST:UPR:FPAN 1
system:upreset:fpanel:state 0
```

Query Syntax SYSTem:UPREset:FPANel[:STATe]?

Return Type Boolean

Default 0

SYSTem:UPReset:LOAD[:FILE] <file>

Applicable Models: E5080A, M9485A

(Write-only) Loads an existing instrument state file (.sta or .cst) to be used for User Preset. Subsequent execution of [SYSTem:UPReset](#) will cause the VNA to assume this instrument state.

Regardless of the state of the User Preset Enable checkbox, the [SYST:PRESet](#) command will always preset the VNA to the factory preset settings, and [SYST:UPReset](#) will always perform a User Preset.

[Learn more about User Preset.](#)

Parameters

<file> String - Name of the file to be loaded. The default folder "C:/Program Files/Keysight/Network Analyzer/Documents" is used if unspecified. Change the default folder name using [MMEMory:CDIRectory](#).

Examples

```
SYST:UPR:LOAD '1MHzto20GHzUserPreset.cst'
system:upreset:load:file 'C:/Documents and
Settings/Administrator/My Documents/NewUserPreset.cst'
```

Query Syntax Not Applicable

Default Not Applicable

SYSTem:UPReset:SAVE[:STATE]

Applicable Models: E5080A, M9485A

(Write-only) Saves the current instrument settings as UserPreset.sta. Subsequent execution of [SYSTem:UPReset](#) will cause the VNA to assume this instrument state.

Regardless of the state of the User Preset Enable checkbox, the [SYST:PRESet](#) command will always preset the VNA to the factory preset settings, and [SYST:UPReset](#) will always perform a User Preset.

[Learn more about User Preset.](#)

Examples

```
SYST:UPR:SAVE
system:upreset:save:state
```

Query Syntax Not Applicable

Default Not Applicable

SYSTem:WINDows:CATalog?

Applicable Models: E5080A, M9485A

(Read-only) Returns the window numbers that are currently being used.

Examples

```
SYST:WIND:CAT?
system:windows:catalog?
```

Return Type String of comma-separated numbers.
For example: "1,2"

Default Not Applicable

Last modified:

7-Jan-2015 Initial Release



SYSTem:CALibrate:ALL Commands

Contains the settings to configure a "Cal All" Calibration.
Use the [Guided Cal](#) interface to perform the calibration.

SYSTem:CALibrate:ALL:**CHANnel:**| [PORTs\[:SElect\]](#)**CSET:**| [CATalog?](#)| [PREFix](#)**GUIDed:**| [CHANnel?](#)| [PORTs?](#)**IFBW****MCLass:**| **PROPerTy:**| [NAME:CATalog?](#)| **VALue:**| [CATalog?](#)| [\[STATE\]](#)**PORT<n>:**| [RECeiver:ATTen](#)| **SOURce:POWer:**| [ATTen](#)| [OFFSet](#)| [\[VALue\]](#)**RESet****SElect**

Click on a [blue](#) keyword to view the command details.

See Also

- [About Calibrate All Channels](#)
- Example Program
- [Guided Cal commands](#)
- [Synchronizing the VNA and Controller](#)

- [SCPI Command Tree](#)

SYSTem:CALibrate:ALL:CHANnel<ch>:PORTs[:SElect] <value>

Applicable Models: E5080A, M9485A

(Write-Read) For each channel to be calibrated, sets and returns the ports to be calibrated. Specify port numbers ONLY for standard channels. [Application channels](#) are not necessary because they have designated input/output/LO ports.

Parameters

<ch> Channel number to be calibrated.

<value> Ports to be calibrated for the specified channel. Select any of the native VNA ports (1,2,3,4).

Examples `SYST:CAL:ALL:CHAN2:PORT 1,2,3`

Query Syntax `SYSTem:CALibrate:ALL:CHANnel<ch>:PORTs[:SElect]?`

Return Type Comma-separated port numbers.

Default 1,2

SYSTem:CALibrate:ALL:CSET:CATalog?

Applicable Models: E5080A, M9485A

(Read-only) Returns the User Cal Set or cal register names that were produced by the cal all session.

Parameters None

Examples `SYST:CAL:ALL:CSET:CATalog?`
'returns this format:
`"MyCalAll_STD_001, MyCalAll_SMC_002"`
 See example program

Return Type String of comma-separated Cal Set or cal register names

Default Not Applicable

SYSTem:CALibrate:ALL:CSET:PREFix<value>

Applicable Models: E5080A, M9485A

(Write-Read) Sets and returns the prefix to be used when saving User Cal Sets that result from the Cal All session. The Meas Class and channel number are appended to this prefix for each calibrated channel. Use [SYST:CAL:ALL:CSET:CATalog?](#) to read the saved cal set names.

- [SENS:CORR:COLL:GUID:SAVE:CSET](#) can also be used to set the Cal Set prefix.
- If a Cal Set prefix is NOT set using either command, the cal data for each channel will be saved only to cal registers. [Learn about cal registers.](#)

Parameters

<value> (String) User Cal Set prefix.

Examples `SYST:CAL:ALL:CSET:PREFix "MyCalAll"`

Query Syntax `SYSTem:CALibrate:ALL:CSET:PREFix?`

Return Type String

Default " " (Empty string)

SYSTem:CALibrate:ALL:GUIDed:CHANnel?

Applicable Models: E5080A, M9485A

(Read-only) Reads the channel number of the Cal All Calibration. Use this value as the <ch> argument for the subsequent [Guided:Cal](#) commands.

Parameters None

Examples `chan = SYST:CAL:ALL:GUID:CHAN?`

Return Type Numeric

Default Not applicable

SYSTem:CALibrate:ALL:GUIDed:PORTs?

Applicable Models: E5080A, M9485A

(Read-only) Returns the ports to be calibrated during the Cal All Channels calibration. Specify connectors and cal kits for these ports using the [Guided:Cal](#) commands.

Specify the ports to be calibrated for each channel using [SYST:CAL:ALL:CHAN<ch>:PORT](#).

Parameters None

Examples `ports = SYST:CAL:ALL:GUID:PORT?`

Return Type Comma-separated list of port numbers

Default Not applicable

SYSTem:CALibrate:ALL:IFBW <value>

Applicable Models: E5080A, M9485A

(Write-Read) Sets and returns the IFBW for a Cal All calibration. [Learn more about this setting.](#)

Parameters

<value> IF Bandwidth in Hz. The list of valid IF Bandwidths is different depending on the VNA model. [See the list of valid settings.](#) If an invalid number is specified, the VNA will round up to the closest valid setting.

This command supports MIN and MAX as arguments. [Learn more.](#)

Examples `SYST:CAL:ALL:IFBW 10e3`

Query Syntax `SYSTem:CALibrate:ALL:IFBW?`

Return Type Numeric

Default 1 kHz

SYSTem:CAL:ALL:MCLass:PROPerTy:NAME:CATalog? [mclass]

Applicable Models: E5080A, M9485A

(Read-only) Returns the unique, settable properties for the current cal all session.

[See a list of valid properties and values for each measurement class.](#)

Parameters

[mclass] Optional argument. String name of the measurement class for which properties are to be returned. See a list of valid measurement class Application names. The measurement class must be included in the current Cal All calibration.

Examples `SYST:CAL:ALL:MCL:PROP:NAME:CAT?`

`'with NFX app, returns:`

`"Noise Cal Method,Noise Tuner,AutoOrient Tuner,Tuner In,Tuner Out,Receiver Characterization Method,ENR File,Noise Source Connector,Noise Source CalKit"`

Return Type String of comma-separated properties.

Default Not applicable

SYSTem:CAL:ALL:MCLass:PROPerTy:VALue:CATalog? <prop>

Applicable Models: E5080A, M9485A

(Read-only) Returns the valid property values for a specific property name.

[See a list of valid properties and values for each measurement class.](#)

Parameters

<prop> (String) Property name for which valid values are to be returned.

Examples

```
SYST:CAL:ALL:MCL:PROP:VAL:CAT? "Noise Cal Method"
'with NFX app, returns:
"Scalar,Vector"
```

Return Type String of comma-separated values

Default Not applicable

SYSTem:CALibrate:ALL:MCLass:PROPerTy:VALue[:STATe] <prop>,<value>

Applicable Models: E5080A, M9485A

(Write-Read) Sets and returns the property value for a specific property name.

[See a list of valid properties and values for each measurement class.](#)

Parameters

<prop> (String) Property name for which value is to be set or returned.

<value> Property value. To read a list of valid values, use [SYST:CAL:ALL:MCL:PROP:VAL:CAT?](#)

Examples

```
SYST:CAL:ALL:MCL:PROP:VAL "Noise Cal Method","Noise:Scalar"
SYST:CAL:ALL:MCL:PROP:VAL? "Noise Source Connector"
```

Query Syntax SYSTem:CALibrate:ALL:MCLass:PROPerTy:VALue[:STATe]? <prop>

Return Type String

Default Varies with the property name.

SYSTem:CALibrate:ALL:PATH:CONFig:ELEMent[:STATe] <element>,<setting>

Applicable Models: E5080A, M9485A

(Write-Read) Sets and returns the Path Configuration settings for a Cal All calibration. [Learn more about this setting.](#)

Parameters

- <element> (String) Path configuration element to be set. See a list of configurable RF Path elements and settings.
- <setting> (String) Path configuration element setting.

Examples

```
SYST:CAL:ALL:PATH:CONFig:ELEMent
"Port1NoiseTuner","Internal"
```

Query Syntax SYSTem:CALibrate:ALL:PATH:CONFig:ELEMent[:STATe]? <element>

Return Type String

Default Not Applicable

SYSTem:CALibrate:ALL:PORT<n>:RECeiver:ATTen<value>[,src]

Applicable Models: E5080A, M9485A

(Write-Read) Sets and returns the Receiver Attenuator setting for a Cal All calibration.

Parameters

- <n> Receiver port number.
- <value> Attenuation value in dB for a Cal All calibration. Choose a valid value for the VNA model. See valid settings.
- [src] String. (NOT case sensitive). Source port. Optional. Use [SOUR:CAT?](#) to return a list of valid port names.
- While this argument can be used to make settings for ALL ports, it is designed to access ports such as an external source, true mode balanced port, or one of the Source 2 outputs on the 2-port 2-source VNA model such as "Port 1 Src2". Otherwise, the <port> argument performs the same function. If both arguments are specified, [src] takes priority.

Examples

```
SYST:CAL:ALL:PORT2:REC:ATT 10
```

Query Syntax SYSTem:CALibrate:ALL:PORT<n>:RECeiver:ATTen?

Return Type Numeric

Default 0

SYSTem:CALibrate:ALL:PORT<n>:SOURce:POWER:ATTen<value>[,src]

Applicable Models: E5080A, M9485A

(Write-Read) Sets and returns the Source Attenuator setting for the Cal All calibration.

Parameters

<n> Source port number.

<value> Attenuation value in dB for the Cal All calibration. Choose a valid value for the VNA model. See valid settings.

[src] String. (NOT case sensitive). Source port. Optional. Use [SOUR:CAT?](#) to return a list of valid port names.

While this argument can be used to make settings for ALL ports, it is designed to access ports such as an external source, true mode balanced port, or one of the Source 2 outputs on the 2-port 2-source VNA model such as "Port 1 Src2". Otherwise, the <port> argument performs the same function. If both arguments are specified, [src] takes priority.

Examples

```
SYST:CAL:ALL:PORT2:SOUR:POW:ATT 10
```

Query Syntax SYSTem:CALibrate:ALL:PORT<n>:SOURce:POWER:ATTen?

Return Type Numeric

Default 0

SYSTem:CALibrate:ALL:PORT<n>:SOURce:POWER:OFFSet <value>[,src]

Applicable Models: E5080A, M9485A

(Write-Read) Sets and returns the power offset value for a Cal All calibration.

Power Offset provides a method of compensating port power for added attenuation or amplification in the source path. The result is that power at the specified port reflects the added components.

Parameters

<n> Source port number.

<value> Power offset value in dB for a Cal All calibration.

- For amplification, use positive offset.
- For attenuation, use negative offset.

[src] String. (NOT case sensitive). Source port. Optional. Use [SOUR:CAT?](#) to return a list of valid port names.

While this argument can be used to make settings for ALL ports, it is designed to access ports such as an external source, true mode balanced port, or one of the Source 2 outputs on the 2-port 2-source VNA model such as "Port 1 Src2".

Otherwise, the <port> argument performs the same function. If both arguments are specified, [src] takes priority.

Examples `SYST:CAL:ALL:PORT2:SOUR:POW:OFFS 10`

Query Syntax `SYSTem:CALibrate:ALL:PORT<n>:SOURce:POWER:OFFSet?`

Return Type Numeric

Default 0

SYSTem:CALibrate:ALL:PORT<n>:SOURce:POWER[:VALue] <value>[,src]

Applicable Models: E5080A, M9485A

(Write-Read) Sets and returns the power level at which a Cal All calibration is to be performed.

Parameters

<n> Source port number.

<value> Power level at which the calibration is to be performed.

[src] String. (NOT case sensitive). Source port. Optional. Use [SOUR:CAT?](#) to return a list of valid port names.

While this argument can be used to make settings for ALL ports, it is designed to access ports such as an external source, true mode balanced port, or one of the Source 2 outputs on the 2-port 2-source VNA model such as "Port 1 Src2".

Otherwise, the <port> argument performs the same function. If both arguments are specified, [src] takes priority.

Examples `SYST:CAL:ALL:PORT2:SOUR:POW 0`

Query Syntax `SYSTem:CALibrate:ALL:PORT<n>:SOURce:POWER[:VALue]?`

Return Type Numeric

Default Preset power of the VNA model.
[See the data sheet for the power level for each model.](#)

SYSTem:CALibrate:ALL:RESet

Applicable Models: E5080A, M9485A

(Write-only) Resets all properties associated with the Cal All session to their default values.

Parameters None

Examples `SYST:CAL:ALL:RES`

Query Syntax Not Applicable

Default Not Applicable

SYSTem:CALibrate:ALL:SElect <value>

Applicable Models: E5080A, M9485A

(Write-Read) Sets and returns the list of channels to be calibrated during the Cal All session.

Parameters

<value> Channel numbers to be calibrated. These channels must already exist.

Examples `SYST:CAL:ALL:SEL 1,2,3`

Query Syntax SYSTem:CALibrate:ALL:SElect?

Return Type Comma-separated channel numbers.

Default Existing channels

Last modified:

16-Mar-2015 First release

External Device Commands

Configures and makes settings for an external device.

```

SYST:CONF:EDEvice:
| ADD
| CAT?
| DRIVe
| DTYPe
| EXISts?
| IOConfig
| IOENable
| LOAD
| REMOve
| SAVE
| STATe
| TOUT
| PMAR More commands
| SOURce:
|   DPP
|   TMODe

```

Click on a **Red** keyword to view the command details.

See Also

- Learn about: [Configure an External Source](#)
- Learn about: [Configure a PMAR Device](#)
- Example: Configure an External Source
- Example: Configure a PMAR Device
- [SYST:PREF:ITEM:EDEV:DPOL](#) - Determines whether external devices remain activated or are de-activated when the VNA is Preset or when a Instrument State is recalled.
- [Synchronizing the VNA and Controller](#)
- [SCPI Command Tree](#)

SYSTem:CONFIgure:EDEVice:ADD <name>

Applicable Models: E5080A, M9485A

(Write-only) Adds an external device to the list of configured devices. This is the same as pressing **New** on the [Select an external device](#) dialog.

Upon creation, all settings on the new device are set to the defaults. The device is not active until set using [SYST:CONF:EDEV:STAT](#)

Parameters

<name> String - Model and type of the external device.
 To see a list of configured external devices, use [SYST:CONF:EDEV:CAT?](#)

Examples

```
SYST:CONF:EDEV:ADD "myDevice"
system:configure:edev:add "myDevice"
```

Query Syntax Not Applicable

Default Not Applicable

SYSTem:CONFIgure:EDEVice:CAT?

Applicable Models: E5080A, M9485A

(Read-only) Returns a list of names of all configured devices. These are devices that appear in the [external devices](#) dialog.

Use [SENS:FOM:CAT?](#) to report all **active** devices.

Use [Source:CAT?](#) to report all **active** sources.

Parameters None

Example

```
SYST:CONF:EDEV:CAT?
system:configure:edev:cat
```

Return Type String of comma-separated devices. "Device0:Driver0, Device1:Driver1"

Default Not applicable

SYSTem:CONFIgure:EDEVice:DRIVER <name>,<value>

Applicable Models: E5080A, M9485A

(Read-Write) Sets and returns the external device driver (model).

Parameters

<name> String - Name of the device.

<value> String - External device driver (model). Choose from the following:
AGPM for all power meters.
AGPULSEGEN for supported pulse generators.
DCSource for all supported DC Sources

DCMeter for all supported DC Meters

[See a list of supported external source drivers.](#)

Examples `SYST:CONF:EDEV:DRIV "myDevice", "AGPM"`
`system:configure:edev:driver "myDevice", "AGESG"`

Query Syntax `SYSTem:CONFigure:EDEVice:DRIVER? <name>`

Return Type String

Default "AGGeneric"

SYSTem:CONFigure:EDEVice:DTYPE <name>,<type>

Applicable Models: E5080A, M9485A

(Read-Write) Sets and returns the Device Type for the external device.

Parameters

<name> String - Name of the device to modify.

<type> String - Device type - not case sensitive. Choose from:
"Source" - external source
"Power Meter" - power meter
"DC Meter" - DC voltmeter
"DC Source" - DC power supply
"Pulse Generator" - external pulse generator

Examples `SYST:CONF:EDEV:DTYP "myDevice", "Power Meter"`
`system:configure:edev:dtype "myDevice", "Source"`

Query Syntax `SYSTem:CONFigure:EDEVice:DTYPe? <name>`

Return Type String

Default None

SYSTem:CONFigure:EDEVice:EXISts? <string>

Applicable Models: E5080A, M9485A

(Read-only) Returns whether the named device is present on the bus for which it is configured.

Parameters

<string> Name of the external device.

Example `SYST:CONF:EDEV:EXIS? "MyPowerMeter"`

Return Type Boolean

- **0** - The device is not in the collection or the device fails to respond and times out when communication is attempted.
- **1** - The device responds when communication is attempted.

Default Not applicable

SYSTEM:CONFigure:EDEvice:IOConfig <name>,<value>

Applicable Models: E5080A, M9485A

(Read-Write) Sets and return the configuration path for the specified external device.

Parameters

<name> String - Name of the device.

<value> String - Configuration path. Any valid VISA resource shown in the IO Configuration field of the [external devices dialog](#), enclosed in quotes. Do NOT use the ID string of a PMAR USB power sensor as the resource string. The ID string is returned by SYST:COMM:USB:PMET:CAT?

Examples `SYST:CONF:EDEV:IOC "myDevice", "GPIB0::13::INSTR"`
`system:configure:edev:ioconfig`
`"myDevice", "GPIB0::13::INSTR"`

Query Syntax `SYSTEM:CONFigure:EDEvice:IOConfig? <name>`

Return Type String

Default " " Empty String

SYSTEM:CONFigure:EDEvice:IOENable <name>,<value>

Applicable Models: E5080A, M9485A

(Read-Write) Enable or disable communication with an external device.

When disabled (OFF), the VNA will NOT attempt to connect to the external device regardless of the instrument state command ([SYST:CONF:EDEV:STATe](#)). Therefore, no errors will be produced if the device is not connected.

This command is useful for debugging and testing states when the external device is not connected. This command is unnecessary in ordinary operation (when the device is connected).

Parameters

<name> String - Name of the device.

<value> Boolean - Choose from:

OFF or **0** - Device communication disabled

ON or **1** - Device communication enabled

Examples

```
SYST:CONF:EDEV:IOEN "myDevice", ON
system:configure:edev:ioenable "myDevice", 0
```

Query Syntax SYSTem:CONFIgure:EDEVice:IOENable? <name>

Return Type Boolean

Default ON

SYSTem:CONFIgure:EDEVice:LOAD <file>,<name>

Applicable Models: E5080A, M9485A

(Write-only) Recalls an external device configuration file from the VNA hard drive.

Currently, only DC Supply and DC Meter configuration files are supported. See more DC Device commands.

Use [SYST:CONF:EDEV:SAVE](#) to save a configuration file.

Parameters

<file> String - Filename of the external device configuration file.

<name> String - Name of the external device. Currently, only DC Supply and DC Meter configuration files are supported.

Examples

```
SYST:CONF:EDEV:LOAD "myDevice.xml", "MyDCMeter"
```

Query Syntax Not Applicable

Default Not Applicable

SYSTem:CONFIgure:EDEVice:REMOve <name>

Applicable Models: E5080A, M9485A

(Write-only) Removes the specified device from the list of configured devices. If the device is a Source and both Active and I/O Enabled is checked (ON), then the RF power state is set to OFF. [Learn more.](#)

Parameters

<name> String - Name of the device. Not case sensitive. Use [SYST:CONF:EDEV:CAT?](#) to return a list of configured devices.

Examples

```
SYST:CONF:EDEV:REM "myDevice"
system:configure:edev:remove "myDevice"
```

Query Syntax Not Applicable

Default Not Applicable

SYSTem:CONFigure:EDEvice:SAVE <file>,<name>

Applicable Models: E5080A, M9485A

(Write-only) Saves an external device configuration file to the VNA hard drive.

Currently, only DC Supply and DC Meter configuration files are supported. See more DC Device commands.

Use [SYST:CONF:EDEV:LOAD](#) to recall a configuration file.

Parameters

<file> String - Filename of the external device configuration file.

<name> String - Name of the external device. Currently, only DC Supply and DC Meter configuration files are supported.

Examples

```
SYST:CONF:EDEV:SAVE "myDevice.xml", "MyDCSupply"
```

Query Syntax Not Applicable

Default Not Applicable

SYSTem:CONFigure:EDEvice:STATE <name>,<value>

Applicable Models: E5080A, M9485A

(Read-Write) Set and return the state of activation of the device. When [SYST:CONF:EDEV:IOEN](#) = ON, and this command is set to ON, the VNA will attempt communication with the external device. An error is returned if communication cannot be verified.

Send this command AFTER sending other external device settings (especially [SYST:CONF:EDEV:DTYP](#))

to avoid communicating with the device before it has been fully configured.

See Also: [SYST:PREF:ITEM:EDEV:DPOL](#) - Determines whether external devices remain activated or are de-activated when the VNA is Preset or when a Instrument State is recalled.

Parameters

<name> String - Name of the device.
 <value> Boolean - Choose from:
OFF or **0** - Device is NOT activated
ON or **1** - Device is activated.

Examples

```
SYST:CONF:EDEV:STAT "myDevice", ON
system:configure:edev:state "myDevice", 0
```

Query Syntax SYSTem:CONFigure:EDEvice:STATe? <name>

Return Type Boolean

Default OFF - When configured using the front panel user interface, the device is ON (activated) by default.

SYSTem:CONFigure:EDEvice:TOUT <name>,<value>

Applicable Models: E5080A, M9485A

(Read-Write) Set and return the time out value for the specified external device. This is the time allowed for communication with the device before an error is generated.

Parameters

<name> String - Name of the device.
 <value> Time out value in seconds.

Examples

```
SYST:CONF:EDEV:TOUT "myDevice",2
system:configure:edev:tout "myDevice",5
```

Query Syntax SYSTem:CONFigure:EDEvice:TOUT? <name>

Return Type Numeric

Default 20

SYSTem:CONFigure:EDEvice:SOURce:DPP <name>,<value>

Applicable Models: E5080A, M9485A

(Read-Write) Sets and returns the amount of time the VNA should wait after for an external source to settle before making a measurement at each data point. This setting applies to all channels that use this external source.

Parameters

<name> String - Name of the device.

<value> Dwell time in seconds.

Examples

```
SYST:CONF:EDEV:SOUR:DPP "myDevice",2
system:configure:edev:source:dpp "myDevice",.1
```

Query Syntax SYSTem:CONFigure:EDEVice:SOURce:DPP? <name>

Return Type Numeric

Default 3.114 e-3

SYSTem:CONFigure:EDEVice:SOURce:TMODe <name>,<value>

Applicable Models: E5080A, M9485A

(Read-Write) Sets and returns the trigger mode for an external source. [Learn more.](#)

Parameters

<name> String - Name of the device.

<value> Trigger Mode. Choose from:

CW - Software CW mode

HW - Hardware list mode

Examples

```
SYST:CONF:EDEV:SOUR:TMOD "myDevice",CW
system:configure:edev:source:tmode "myDevice",hw
```

Query Syntax SYSTem:CONFigure:EDEVice:SOURce:TMODe? "myDevice"

Return Type Character

Default Depends on Source and VNA Model

Last Modified:

16-Mar-2015 First Release

SYST:CONF:EDEvice:PMAR Commands

Configures and makes settings for an external Power Meter as Receiver.

SYSTem:CONFIgure:EDEVice:PMAR

```

| CALibrate
| FLIMit
| FMAXimum
| FMINimum
| READing:
  | COUNT
  | NTOLerance
| SENSor
| TABLE:
  | CFAC:
    | DATA
    | FREQuency
  | LOSS:
    | DATA
    | FREQuency
    | STATE
  | RFACTor
| ZERO

```

Click on a [blue](#) keyword to view the command details.

See Also

- Learn about: [Configure a Power Meter As Receiver](#)
- See root [SYST:CONF:EDEV](#) commands
- Learn about [Configure and External Device](#)
- [SYST:PREF:ITEM:EDEV:DPOL](#) - Determines whether External Devices remain activated or are de-activated when the VNA is Preset or when a Instrument State is recalled.
- [Synchronizing the VNA and Controller](#)
- [SCPI Command Tree](#)

SYSTem:CONFIgure:EDEVice:PMAR:CALibrate <name>

Applicable Models: E5080A, M9485A

(Write-only) Performs a calibration of the power sensor. Calibration usually involves connecting the power sensor to the meter's 1 mW reference.

- Keysight P-Series sensors have an internal reference so you can calibrate them using this command without connecting to the meters reference port.

- Keysight USB power sensors do not require calibrating.
- For other sensors, refer to the documentation to determine if it has calibration capability.

This command is always synchronous, so *OPC? is the only way to determine that the operation is complete. Set an I/O timeout of at least 20 seconds.

Parameters

<name> String - Name of the power meter.

Examples

```
SYST:CONF:EDEV:PMAR:CAL "myDevice"
system:configure:edevic:pmar:calibrate "myDevice"
```

Query Syntax Not Applicable

Default Not Applicable

SYSTem:CONFigure:EDEVice:PMAR:FLIMit <name>,<value>

Applicable Models: E5080A, M9485A

(Read-Write) Enable or disable the power meter min and max frequencies.

Parameters

<name> String - Name of the power meter.

<value> Boolean. State of min and max frequency. Choose from:

OFF or **0** - Min and max frequencies disabled.

ON or **1** - Min and max frequencies enabled.

Examples

```
SYST:CONF:EDEV:PMAR:FLIM "myDevice", 0
system:configure:edevic:pmar:flimit "myDevice", ON
See example program
```

Query Syntax SYSTem:CONFigure:EDEVice:PMAR:FLIMit? <name>

Return Type Boolean

Default OFF

SYSTem:CONFigure:EDEVice:PMAR:FMAXimum <name>,<value>

Applicable Models: E5080A, M9485A

(Read-Write) Set and return the maximum frequency of the power meter.

Parameters

<name> String - Name of the power meter.

<value> Numeric - Max frequency in Hz.

Examples

```
SYSTem:CONF:EDEv:PMAR:FMAX "myDevice", 1e10
system:configure:edevic:pmar:fmaximum "myDevice", 3e9
See example program
```

Query Syntax SYSTem:CONF:EDEv:PMAR:FMAXimum? <name>

Return Type Numeric

Default Not Applicable

SYSTem:CONF:EDEv:PMAR:FMINimum <name>,<value>

Applicable Models: E5080A, M9485A

(Read-Write) Set and return the minimum frequency of the power meter.

Parameters

<name> String - Name of the power meter.

<value> Numeric - Min frequency in Hz.

Examples

```
SYSTem:CONF:EDEv:PMAR:FMIN "myDevice", 1e10
system:configure:edevic:pmar:fminimum "myDevice", 3e9
See example program
```

Query Syntax SYSTem:CONF:EDEv:PMAR:FMAXimum? <name>

Return Type Numeric

Default Not Applicable

SYSTem:CONF:EDEv:PMAR:READING:COUNT <name>,<value>

Applicable Models: E5080A, M9485A

(Read-Write) This command, along with SYST:CONF:EDEV:PMAR:READ:NTOL, allows for settling of the power sensor READINGS.

Set and return the maximum number of power readings that are taken at each stimulus point to allow for measurement settling. Each reading is averaged with the previous readings at that stimulus point.

When this average meets the Average:NTOLerance value or this number of readings has been made, the average is returned as the valid reading.

Parameters

<name> String - Name of the power meter.

<value> Number of readings. Choose a value between 1 and 25

Examples

```
SYST:CONF:EDEV:PMAR:READ:COUN "myDevice", 20
system:configure:edevic:pmar:reading:count "myDevice", 10
See example program
```

Query Syntax SYSTem:CONFigure:EDEVice:PMAR:READING:COUNT? <name>

Return Type Numeric

Default 3

SYSTem:CONFigure:EDEVice:PMAR:READING:NTOLerance <name>,<value>

Applicable Models: E5080A, M9485A

(Read-Write) This command, along with SYST:CONF:EDEV:PMAR:READ:COUN, allows for settling of the power sensor READINGS.

Each power reading is averaged with the previous readings at each stimulus point. When the average meets this nominal tolerance value, or the max number of readings has been made, the average is returned as the valid reading.

Parameters

<name> String - Name of the power meter.

<value> Power measurement settling tolerance value in dB. Choose any number between 0 and 5.

Examples

```
SYST:CONF:EDEV:PMAR:READ:NTOL "myDevice", .5
system:configure:edevic:pmar:reading:ntolerance
"myDevice", .01
See example program
```

Query Syntax SYSTem:CONFigure:EDEvice:PMAR:READing:NTOLerance? <name>

Return Type Numeric

Default .05

SYSTem:CONFigure:EDEvice:PMAR:SENSor <name>,<value>

Applicable Models: E5080A, M9485A

(Read-Write) Sets and returns the power sensor channel (1 or 2) to be used. This performs the same function as the **Use this sensor only** checkbox.

Parameters

<name> String - Name of the power meter.

<value> Power Meter channel.

1 - Channel A

2 - Channel B

Examples

```
SYST:CONF:EDEV:PMAR:SENS "myDevice",2
system:configure:edevic:pmar:sensor "myDevice",1
See example program
```

Query Syntax SYSTem:CONFigure:EDEvice:PMAR:SENSor? <name>

Return Type Numeric

Default 1

SYSTem:CONFigure:EDEvice:PMAR:TABLE:CFAC:DATA <name>,<value>[,value]

Applicable Models: E5080A, M9485A

(Read-Write) Sets and returns the cal factor data for the power sensor.

Parameters

<name> String - Name of the power meter.

<value>[,value] Cal factor data in percent. For each frequency used with SYST:CONF:EDEV:PMAR:TABL:CFAC:FREQ, enter a cal factor number between 1 and 100.

Examples `SYST:CONF:EDEV:PMAR:TABL:CFAC:DATA "myDevice", 98,99,99`
`system:configure:edevic:pmar:table:cfac:data "myDevice",`
`97,97,97`
 See example program

Query Syntax `SYSTEM:CONFIGure:EDEVice:PMAR:TABLE:CFAC:DATA? <name>`

Return Type Numeric - one number per table segment.

Default Not Applicable

SYSTEM:CONFIGure:EDEVice:PMAR:TABLE:CFAC:FREQuency <name>,<value>[,value]

Applicable Models: E5080A, M9485A

(Read-Write) Sets and returns the cal factor frequencies for the power sensor.

Parameters

<name> String - Name of the power meter.

<value>[,value] Cal factor frequencies in Hz.

Examples `SYST:CONF:EDEV:PMAR:TABL:CFAC:FREQ "myDevice", 1e7,1e8,1e9`
`system:configure:edevic:pmar:table:cfac:frequency`
`"myDevice", 5e7,5e8,5e9`
 See example program

Query Syntax `SYSTEM:CONFIGure:EDEVice:PMAR:TABLE:CFAC:FREQuency?<name>`

Return Type Numeric - one number per table segment.

Default Not Applicable

SYSTEM:CONFIGure:EDEVice:PMAR:TABLE:LOSS:DATA <name>,<value>[,value]

Applicable Models: E5080A, M9485A

(Read-Write) Sets and returns the power loss data for the power sensor.

Each table can contain up to 9999 segments. Values can also be loaded using the Characterize Adapter macro.

Parameters

<name> String - Name of the power meter.

<value>[,value] Loss data in dB. POSITIVE values in dB are interpreted as LOSS. To compensate for gain, use negative values.
For each frequency used with SYST:CONF:EDEV:PMAR:TABLE:LOSS:FREQ, enter a cal factor number between 1 and 100.

Examples

```
SYST:CONF:EDEV:PMAR:TABLE:LOSS:DATA "myDevice",.01,.02,.03
system:configure:edevic:pmar:table:loss:data "myDevice",
.04,.05,.06
```

See example program

Query Syntax SYSTem:CONFigure:EDEVice:PMAR:TABLE:CFAC:DATA? <name>

Return Type Numeric - one number per table segment.

Default Not Applicable

SYSTem:CONFigure:EDEVice:PMAR:TABLE:LOSS:FREQuency <name>,<value>[,value]

Applicable Models: E5080A, M9485A

(Read-Write) Sets and returns frequencies for the power loss data.

Parameters

<name> String - Name of the power meter.

<value>[,value] Power Loss frequencies in Hz.

Examples

```
SYST:CONF:EDEV:PMAR:TABLE:LOSS:FREQ "myDevice",1e7,1e8,1e9
system:configure:edevic:pmar:table:loss:frequency
"myDevice",5e7,5e8,5e9
```

See example program

Query Syntax SYSTem:CONFigure:EDEVice:PMAR:TABLE:LOSS:FREQuency? <name>

Return Type Numeric - one number per table segment.

Default Not Applicable

SYSTem:CONFigure:EDEVice:PMAR:TABLE:LOSS:STATe <name>,<value>

Applicable Models: E5080A, M9485A

(Read-Write) Sets and returns whether to use the power loss table.

Parameters

<name> String - Name of the power meter.

<value> Boolean. State of the power loss table. Choose from:

OFF or **0** - Power loss table not used.

ON or **1** - Power loss table used.

Examples

```
SYST:CONF:EDEV:PMAR:TABL:LOSS:STAT "myDevice",1
system:configure:edevic:pmar:table:loss:state "myDevice",1
See example program
```

Query Syntax SYSTem:CONFigure:EDEVice:PMAR:TABLE:LOSS:STATe? <name>

Return Type Boolean

Default OFF

SYSTem:CONFigure:EDEVice:PMAR:TABLE:RFACtor <name>,<value>

Applicable Models: E5080A, M9485A

(Read-Write) Sets and returns the reference cal factor for the power sensor.

Note: If the sensor connected to the power meter contains cal factors in EPROM (such as the Keysight E-series power sensors), those will be the cal factors used. The reference cal factor value associated with this command, and any cal factors entered into the VNA for that sensor channel, will not be used.

Parameters

<name> String - Name of the power meter.

<value> Reference cal factor in percent. Choose any number between 1 and 150.

Examples

```
SYST:CONF:EDEV:PMAR:TABL:RFAC "myDevice", 1
system:configure:edevic:pmar:table:rfactor "myDevice", 1
See example program
```

Query Syntax SYSTem:CONFigure:EDEVice:PMAR:TABLE:RFACtor? <name>

Return Type Numeric

Default 100

SYSTem:CONFigure:EDEvice:PMAR:ZERO <name>[,SYNC,<value>]

Applicable Models: E5080A, M9485A

(Write-only) Performs a zeroing of the PMAR device.

This command is always synchronous, so *OPC? is the only way to determine that the operation is complete. Set an I/O timeout of at least 20 seconds.

Keysight P-Series sensors do ONLY Internal zeroing. These, and Keysight USB power sensors when Internal is selected, do NOT require disconnecting from the measurement path before zeroing.

All other Keysight sensors do ONLY External zeroing.

Parameters

<name> String - Name of the power meter.

[,SYNC,<value>] Optional argument for use with power sensors that support both internal and external types of zeroing such as Keysight USB power sensors.

Choose from:

SYNC,INTernal - Internal zeroing. Power is automatically removed from the sensor input before zeroing occurs (Default setting).

SYNC,EXTernal - External zeroing. First remove the sensor input, then send this command. External zeroing is recommended for powers below -30 dBm with the U2000-Series sensors (-20 dBm for the H models).

Examples

```
SYST:CONF:EDEV:PMAR:ZERO "myDevice"
system:configure:edevice:pmar:zero "myDevice",sync,internal
```

Query Syntax Not Applicable

Default Not Applicable

Last Modified:

16-Mar-2015 First Release

SYSTEM:CORRection:INTErpolate:LINear Commands**Applicable Models:** E5080A, M9485A

The five **SYSTEM:CORRection:INTErpolate:LINear** commands are used as a sequence. They are not meant to be used independent of the others. The commands perform linear interpolation on a scalar data of (x,y) pairs based on a master set of x and y values to a new mapping based on a desired set of x values. The desired set of x values (or range) must fall within the master set of x values (or range) and can have a different number of points than the master data set.

Definition:

Linear interpolation operates by drawing a straight line between each two adjacent data points on the master (x,y) pairs that fall on either side of the new desired data point represented by (x',y'). in other words if

(xi, yi) represents data pairs on the master data set and (xj',yj') represents a data point on the interpolated result data set then:

$$X_i < X_j' < X_{i+1} \text{ and } Y_j' = Y_i + [(Y_{i+1} - Y_i)/(X_{i+1} - X_i)] (X_j' - X_i)$$

Note: The master data set must represent a function on the Cartesian coordinate system. In other words, for each x value in the master data set, there can be only one corresponding Y value.

There are five steps in the sequence:

1. SYSTEM:CORRection:INTErpolate:LINear:INPUt:X - loads in the master X values
2. SYSTEM:CORRection:INTErpolate:LINear:INPUt:Y - loads in the master Y values
3. SYSTEM:CORRection:INTErpolate:LINear:OUTPUt:X - loads in the desired interpolated X values
4. SYSTEM:CORRection:INTErpolate:LINear:CALCulate - calculates the interpolated Y values
5. SYSTEM:CORRection:INTErpolate:LINear:OUTPUt:Y? - reads back the interpolated Y values.

Example

The following function uses the SYSTEM:CORRection:INTErpolate:LINear commands:

```
Function InterpolateData_Single(inputX() As Double, inputY() As Single,
outputX() As Double, ByRef interpData() As Single)
    x = visa_io.ag_send_binBlock64("SYST:CORR:INT:LIN:INP:X ", inputX)
    x = visa_io.ag_send_binBlock("SYST:CORR:INT:LIN:INP:Y ", inputY)
    x = visa_io.ag_send_binBlock64("SYST:CORR:INT:LIN:OUTP:X ", outputX)
    x = visa_io.ag_send_rd("*OPC?")
    x = visa_io.ag_send_wait("SYST:CORR:INT:LIN:CALC")
    x = visa_io.ag_send_rd("*OPC?")
    interpData = visa_io.ag_send_rd_binBlock("SYST:CORR:INT:LIN:OUTP:Y?")
    CheckError
```

End Function

```
'Here is a code snippet that uses the function above.
'copy the B-Response Error term from one calset to another.
'The source calset has a super set stimulus and
'and the receiving calset has a subset stimulus
```

```
Dim BResp_freqList() As Double
Dim BResp_Re() As Single
Dim BResp_Im() As Single

GetErrorTerm_noChan BResp_Calset, "ResponseTracking(B)",
BResp_freqList, BResp_Re, BResp_Im

Dim Noise_freqList() As Double

GetCalsetStimulus calsetName, Noise_freqList, 1, "Noise Figure Cold
Source"
' Response Stimulus Range

Dim BResp_Re_interp() As Single
Dim BResp_Im_interp() As Single

InterpolateData_Single BResp_freqList, BResp_Re, Noise_freqList,
BResp_Re_interp
InterpolateData_Single BResp_freqList, BResp_Im, Noise_freqList,
BResp_Im_interp

PutErrorTerm channel, calsetName, "ResponseTracking(B)",
BResp_Re_interp, BResp_Im_interp
```

Last Modified:

18-Mar-2015 First Release

System Preferences Commands

Sets and reads the VNA Preferences settings.

```
SYSTem:PREFerences
| DEFault
| ITEM
  | EEXTrapolate
  | EDEV: DPOLicy
  | GDELay:TWOPoint
  | MCControl
  | MCMethod
  | MCPreset
  | MRU
  | OFFSet
    | RCV
    | SRC
  | PRESet:POWER:STATE
  | PSRTrace
  | RECeivers
    | CERRor
    | OVERload:POWER
  RETRace:POWER
  | RTOF
  | SWITCh:DEF
```

Click on a [Red](#) keyword to view the command details.

See Also

- [SENS:CORRection:PREFerences](#)
- Learn about VNA Preferences
- Example Programs
- [Synchronizing the VNA and Controller](#)
- [SCPI Command Tree](#)

SYSTem:PREFerences:DEFault

Applicable Models: E5080A, M9485A

(Write-only) Resets the VNA preferences to their default settings. Some default settings vary depending on the VNA Model. Learn more about VNA Preferences.

Examples `SYST:PREF:DEF`
`system:preferences:default`

Query Syntax Not Applicable

Default Not Applicable

SYSTem:PREFerences:ITEM:EDEV:DPOLicy <bool>

Applicable Models: E5080A, M9485A

(Read-Write) Set and return whether External Devices remain activated or are de-activated when the VNA is Preset or when a Instrument State is recalled.

This setting remains until changed again using this command, or until the hard drive is changed or reformatted.

Parameters

<bool> Choose from:

OFF (0) External devices **remain active** when the VNA is Preset or when a Instrument State is recalled.

ON (1) External devices are **de-activated** ([SYST:CONF:EDEV:STAT](#) to OFF) when the VNA is Preset or when a Instrument State is recalled.

Examples `SYST:PREF:ITEM:EDEV:DPOL 1`
`system:preferences:item:edev:dpolicy OFF`

Query Syntax SYSTem:PREFerences:ITEM:EDEV:DPOLicy?

Return Type Boolean

Default ON or 1

SYSTem:PREFerences:ITEM:EEXTRapolate <bool>

Applicable Models: E5080A, M9485A

(Read-Write) Sets whether a Swept IMD or IMDx calibration can exceed the stop frequency limit of an ECal module. [Learn more.](#)

Parameters

<bool> Choose from:

ON (1) Allow extrapolation.

OFF (0) Do NOT allow extrapolation.

Examples `SYST:PREF:ITEM:EEXT 1`
`system:preferences:item:eextrapolate OFF`

Query Syntax `SYSTEM:PREferences:ITEM:EEXTrapolate?`

Return Type Boolean

Default OFF

SYSTEM:PREferences:ITEM:GDElay:TWOPoint <bool>

Applicable Models: E5080A, M9485A

(Read-Write) Sets the default group delay aperture setting. [Learn more about group delay aperture.](#)

Parameters

<bool> Choose from:
ON (1) Sets default group delay aperture to 2 points.
OFF (0) Sets default group delay aperture to 11 points.

Examples `SYST:PREF:ITEM:GDElay:TWOPoint 1`
`system:preferences:item:gdelay:twopoint OFF`

Query Syntax `SYSTEM:PREferences:ITEM:GDElay:TWOPoint?`

Return Type Boolean

Default OFF

SYSTEM:PREferences:ITEM:MCControl <bool>

Applicable Models: None

(Read-Write) Set and return whether the Coupled Markers setting controls the ON|OFF state of markers that are coupled. [Learn more about Coupled Markers.](#) Refer also to [CALC:MARK:COUP:STATE ON.](#)

Parameters

<bool> Choose from:
ON (1) – With Coupled Markers ON, when a marker is turned on, the same-numbered marker on all coupled traces will also be turned on. Likewise, turning off a marker will turn it off on all coupled traces.
OFF (0) – Turning a marker on or off will have no effect on the markers on other

traces.

Examples `SYST:PREF:ITEM:MCC 1`
`system:preferences:item:mccontrol OFF`

Query Syntax `SYSTem:PREFerences:ITEM:MCControl?`

Return Type Boolean

Default OFF (0)

SYSTem:PREFerences:ITEM:MCMMethod <bool>

Applicable Models: None

(Read-Write) Set and return whether Coupled Markers is set to Channel or All after Preset. [Learn more about Coupled Markers](#). Refer also to [CALC:MARK:COUP:STATE ON](#) and [SYST:PREF:ITEM:MCPR ON](#).

Parameters

<bool> Choose from:
ON (1) – Marker Coupling Method is set to Channel after Preset.
OFF (0) – Marker Coupling Method is set to ALL after Preset.

Examples `SYST:PREF:ITEM:MCM 1`
`system:preferences:item:mcmethod OFF`

Query Syntax `SYSTem:PREFerences:ITEM:MCMMethod?`

Return Type Boolean

Default OFF (0)

SYSTem:PREFerences:ITEM:MCPRest <bool>

Applicable Models: None

(Read-Write) Set and return whether Coupled Markers is set to ON or OFF after Preset. [Learn more about Coupled Markers](#).

Parameters

<bool> Choose from:
OFF (0) – Coupled Markers is OFF after Preset.
ON (1) – Coupled Markers is ON after Preset.

Examples `SYST:PREF:ITEM:MCPR 1`
`system:preferences:item:mcpreset OFF`

Query Syntax `SYSTem:PREFerences:ITEM:MCPRreset?`

Return Type Boolean

Default OFF (0)

SYSTem:PREFerences:ITEM:MRU <bool>

Applicable Models: E5080A, M9485A

(Read-Write) Set and return whether to list files for recall on softkeys by most-recently used or alphabetically.

Parameters

<bool> Choose from:
ON (1) – Recall softkeys show most recently-used files.
OFF (0) – Recall softkeys show alphabetically-ordered files.

Examples `SYST:PREF:ITEM:MRU 1`
`system:preferences:item:mru OFF`

Query Syntax `SYSTem:PREFerences:ITEM:MRU?`

Return Type Boolean

Default OFF (0)

SYSTem:PREFerences:ITEM:OFFSet:RCV <bool>

Applicable Models: E5080A, M9485A

(Read-Write) Set and return whether to offset the test port receivers by the amount of receiver attenuation. [Learn more.](#)

To send this command using the VNA front panel, open the [GPIB Command Processor Console](#), then type either of the following examples at the command prompt. Then type the Query Syntax and press enter to be sure the VNA took the command.

This setting remains until changed again using this command, or until the hard drive is changed or reformatted.

Parameters

<bool> Choose from:
ON (1) Offset the test port receivers
OFF (0) Do NOT offset the test port receivers

Examples `SYST:PREF:ITEM:OFFS:RCV 1`
`system:preferences:item:offset:rcv OFF`

Query Syntax `SYSTem:PREFerences:ITEM:OFFSet:RCV?`

Return Type Boolean

Default PNA-L and E836xB: **OFF** (does NOT offset the display).
VNA: **ON** (offsets the display).

SYSTem:PREFerences:ITEM:OFFSet:SRC <bool>

Applicable Models: E5080A, M9485A

(Read-Write) Set and return whether to offset the reference receiver by the amount of source attenuation.
[Learn more.](#)

To send this command using the VNA front panel, open the [GPIB Command Processor Console](#), then type either of the following examples at the command prompt. Then type the Query Syntax and press enter to be sure the VNA took the command.

This setting remains until changed again using this command, or until the hard drive is changed or reformatted.

Parameters

<bool> Choose from:
ON (1) Offset the reference receivers.
OFF (0) Do NOT Offset the reference receivers.

Examples `SYST:PREF:ITEM:OFFS:SRC 1`
`system:preferences:item:offset:src OFF`

Query Syntax `SYSTem:PREFerences:ITEM:OFFSet:SRC?`

Return Type Boolean

Default All models: **ON** (offset the display).

SYSTem:PREFerences:ITEM:PRESet:POWer[:STATe] <char>

Applicable Models: E5080A, M9485A

(Read-Write) Set and return the Preset Power ON/OFF state. [Learn more.](#)

This setting remains until changed again using this command, or until the hard drive is changed or reformatted.

Parameters

<char> Choose from:

ON - Instrument Preset always turns RF power ON.

AUTO - When the current power setting is OFF, leave power OFF after Preset. When the current power setting is ON, turn power ON after Preset.

Examples

```
SYST:PREF:ITEM:PRE:POW ON
system:preferences:item:preset:power:state auto
```

Query Syntax SYSTem:PREFerences:ITEM:PREset:POWer[:STATe]?

Return Type Character

Default ON

SYSTem:PREFerences:ITEM:PSRTrace <char>

Applicable Models: E5080A, M9485A

(Read-Write) At the end of a power sweep, while waiting to trigger the next sweep, maintain source power at either the start power level or at the stop power level.

To send this command using the VNA front panel, open the [GPIB Command Processor Console](#), then type either of the following examples at the command prompt. Then type the Query Syntax and press enter to be sure the VNA took the command.

This setting remains until changed again using this command, or until the hard drive is changed or reformatted.

Parameters

<char> Choose from:

START - Maintain source power at the start power level.

STOP - Maintain source power at the stop power level.

Examples

```
SYST:PREF:ITEM:PSRT STOP
system:preferences:item:psrtrace start
```

Query Syntax SYSTem:PREFerences:ITEM:PSRTrace?

Return Type Character

Default START

SYSTem:PREFerences:ITEM:RECEivers:CERRor[:STATe] <bool>

Applicable Models: E5080A, M9485A

(Read-Write) Set and return whether to display receiver overload warnings. [Learn more.](#)

Parameters

<bool> Choose from:
ON (1) Display overload warnings,
OFF (0) Do NOT display overload warnings.

Examples

```
SYST:PREF:ITEM:REC:CERR 1
system:preferences:item:receivers:cerror:state OFF
```

Query Syntax SYSTem:PREFerences:ITEM:RECEivers:CERRor[:STATe]?

Return Type Boolean

Default ON

SYSTem:PREFerences:ITEM:RECEivers:OVERload:POWER[:STATe] <bool>

Applicable Models: E5080A, M9485A

(Read-Write) Set and return whether to turn source power OFF when a receiver is overloaded. [Learn more.](#)

Parameters

<bool> Choose from:
ON (1) Turn OFF source power to ALL ports when a receiver is overloaded.
OFF (0) Power remains ON when a receiver is overloaded.

Examples

```
SYST:PREF:ITEM:REC:OVER:POW 1
system:preferences:item:receivers:overload:power:state OFF
```

Query Syntax SYSTem:PREFerences:ITEM:RECEivers:OVERload:POWER[:STATe]?

Return Type Boolean

Default OFF (0)

SYSTem:PREFerences:ITEM:RETRace:POWer <char>

Applicable Models: E5080A, M9485A

(Read-Write) For single-band frequency or segment sweeps ONLY, specify whether to turn RF power ON or OFF during a retrace. [Learn more about RF power during sweep retrace.](#)

To send this command using the VNA front panel, open the [GPIB Command Processor Console](#), then type either of the following examples at the command prompt. Then type the Query Syntax and press enter to be sure the VNA took the command.

This setting remains until changed using this command, or until the hard drive is changed or reformatted.

Parameters

<char> Choose from:

AUTO: Power is left ON during retrace of single-band frequency or segment sweeps ONLY.

OFF: Power is turned OFF during retrace of single-band frequency or segment sweeps ONLY.

Examples

```
SYST:PREF:ITEM:RETR:POW OFF
system:preferences:item:retrace:power auto
```

Query Syntax SYSTem:PREFerences:ITEM:RETRace:POWer?

Return Type Character

Default AUTO

SYSTem:PREFerences:ITEM:RTOF <bool>

Applicable Models: E5080A, M9485A

(Read-Write) Set and return whether to display limit line failures as red trace segments or red data points (dots). [Learn more.](#)

Parameters

<bool> Choose from:

ON (1) Display failures as red trace segments. (Red Trace On Fail).

OFF (0) Display failures as red data points (dots).

Examples

```
SYST:PREF:ITEM:RTOF 1
system:preferences:item:rtof OFF
```

Query Syntax SYSTem:PREFerences:ITEM:RTOF?

Return Type Boolean

Default OFF

SYSTem:PREFerences:ITEM:SWITCh:DEF <string>, <int>

Applicable Models: E5080A, M9485A

(Read-Write) Sets the default setting for the Noise Tuner switch. This is the setting that occurs when a new channel is created. Learn more.

This command will return an error on VNA models with a built-in Noise tuner.

To send this command using the VNA front panel, open the [GPIB Command Processor Console](#), then type either of the following examples at the command prompt. Then type the Query Syntax and press enter to be sure the VNA took the command.

This setting remains until changed using this command, or until the hard drive is changed or reformatted.

Parameters

<string> Name of the switch to set. Choose from:

- **"Port1NoiseTuner"**

<int> Value to set. Choose from:

0 Sets the default (preset) to INTERNAL

1 Sets the default (preset) to EXTERNAL

Examples

```
SYST:PREF:ITEM:SWIT:DEF "Port1NoiseTuner" 1 'Write
system:preferences:item:switch:def? "Port1NoiseTuner" 'Read
```

Query Syntax SYSTem:PREFerences:ITEM:SWITCh:DEF? <switch>

Return Type Integer

Default 1 (External)

Last Modified:

16-Mar-2015 Initial Release

Trigger Commands

Controls External Triggering .

TRIGger:**AUX**| [COUNT](#)**CHANnel:AUX**| [DURATION](#)| [\[ENABLE\]](#)| [INTERVAL](#)| [OPOLarity](#)| [POSITION](#)| [TYPE](#)[DElay](#)**PREference**| [AIGLobal](#)[READY:POLarity](#)**[SEQUence]**| [SCOPE](#)| [SOURCE](#)| [SLOPE](#)| [TYPE](#)

Click on a **Red** keyword to view the command details.

See Also

- [Example program Triggering the VNA](#)
- See other SCPI Triggering commands
- [Learn about External / Aux Triggering](#)
- [Synchronizing the VNA and Controller](#)

- [SCPI Command Tree](#)

TRIGger:AUXiliary:COUNT?**Applicable Models:** E5080A**(Read-only)** Returns the number of AUX trigger output connector in the instrument.**Parameters**

Examples

```
TRIG:AUX:COUN?
trigger:auxiliary:count?
```

Return Type Numeric**Default** Not Applicable**TRIGger:CHANnel<ch>:AUXiliary<n>:DURation <num>****Applicable Models:** E5080A**(Read-Write)** Specifies the width of the output pulse, which is the time that the Aux trigger output will be asserted.**Parameters**

<ch> Any existing channel number. If unspecified, value is set to 1.

<n> Rear panel connector used to send or receive signals.
If unspecified, value is set to 1.

<num> Duration value in seconds. Choose a value between 1us (1E-6) and 1.

Examples

```
TRIG:CHAN:AUX:DUR .1
trigger:channel2:aux:duration .01
```

Query Syntax TRIGger:CHANnel<ch>:AUXiliary<n>:DURation?**Return Type** Numeric**Default** 1E-6**TRIGger:CHANnel<ch>:AUXiliary<n>[:ENABLE] <bool>****Applicable Models:** E5080A**(Read-Write)** Turns ON / OFF the trigger output.**Parameters**

<ch> Any existing channel number. If unspecified, value is set to 1.

<n> Rear panel connector used to send or receive signals.
If unspecified, value is set to 1.

<bool> **ON or 1** - Turns trigger output ON.
OFF or 0 - Turns trigger output OFF.

Examples `TRIG:CHAN:AUX 1`
`trigger:channel2:aux:enable off`

Query Syntax `TRIGger:CHANnel<ch>:AUXiliary<n>:[ENABLE]?`

Return Type Boolean

Default OFF

[TRIGger:CHANnel<ch>:AUXiliary<n>:INTerval <char>](#)

Applicable Models: E5080A

(Read-Write) Specifies how often a trigger output signal is sent.

Parameters

<ch> Any existing channel number. If unspecified, value is set to 1.

<n> Rear panel connector used to send or receive signals.
If unspecified, value is set to 1.

<char> Choose from:

-
- **SWEep** - Trigger signal is sent once every sweep.

Examples `TRIG:CHAN:AUX:INT POI`
`trigger:channel2:aux:interval sweep`

Query Syntax `TRIGger:CHANnel<ch>:AUXiliary<n>:INTerval?`

Return Type Character

SWEep

[TRIGger:CHANnel<ch>:AUXiliary<n>:OPOLarity <char>](#)

Applicable Models: E5080A

(Read-Write) Specifies the polarity of the Aux Output signal being supplied by the VNA.

Parameters

<ch> Any existing channel number. If unspecified, value is set to 1.

<n> Rear panel connector used to send or receive signals.
If unspecified, value is set to 1.

<char> Choose from:

- **POSitive** - VNA sends positive going pulse.
- **NEGative** - VNA sends negative going pulse.

Examples

```
TRIG:CHAN:AUX:OPOL NEG
trigger:channel2:aux:polarity positive
```

Query Syntax TRIGger:CHANnel<ch>:AUXiliary<n>:OPOLarity?

Return Type Character

Default NEGative

[TRIGger:CHANnel<ch>:AUXiliary<n>:POSition <char>](#)

Applicable Models: E5080A

(Read-Write) Specifies whether the aux trigger out signal is sent **BEFORE** or **AFTER** the acquisition.

Parameters

<ch> Any existing channel number. If unspecified, value is set to 1.

<n> Rear panel connector used to send or receive signals.
If unspecified, value is set to 1.

<char> Choose from:

- **BEFORE** - Use if the external device needs to be triggered before the data is acquired, such as a power meter.
- **AFTER** - Use if the external device needs to be triggered just after data has been acquired, such as an external source. This could be more efficient since it allows the external device to get ready for the next acquisition at the same time as the VNA.

Examples

```
TRIG:CHAN:AUX:POS BEF
trigger:channel2:aux:position after
```

Query Syntax TRIGger:CHANnel<ch>:AUXiliary<n>:POSition?

Return Type Character

Default AFTer

TRIGger:CHANnel<ch>:AUXiliary<n>:TYPE <char>

Applicable Models: E5080A

(Read-Write) Specifies the type of Aux input detection that the VNA will employ.

Parameters

<ch> Any existing channel number. If unspecified, value is set to 1.

<n> Rear panel connector used to send or receive signals.
If unspecified, value is set to 1.

<char> Choose from:

EDGE - VNA responds to the leading edge of a signal.

LEVel - VNA responds to the level (HIGH or LOW) of a signal.

Examples

```
TRIG:CHAN:AUX:TYPE EDGE
trigger:channel2:aux:type level
```

Query Syntax TRIGger:CHANnel<ch>:AUXiliary<n>:TYPE?

Return Type Character

Default EDGE

TRIGger:DELay <num>

Applicable Models: E5080A, M9485A

(Read-Write) Sets and reads the trigger delay for ALL channels (globally). This delay is only applied while [TRIG:SOURce](#) = EXTernal and [TRIG:SCOP](#) = ALL After an external trigger is applied, the start of the sweep is held off for an amount of time equal to the delay setting plus any inherent latency.

To apply a trigger delay for the specified channel ONLY, use [SENS:SWE:TRIG:DELay](#)

Parameters

<num> Delay value in seconds. Choose from 0 to 107.

Examples

```
TRIG:DEL .0003
```

Sets the trigger delay to 300 microseconds. The sweep will not start until approximately 300 microseconds after an external trigger is applied.

Query Syntax TRIGger:DELay?

Return Type Numeric

Default 0

TRIGger:PREFerece:AIGLobal <bool>**Applicable Models:** E5080A**(Read-Write)** Sets the Trigger OUT behavior to either Global or Channel. [Learn more about this setting.](#)

This command will cause the VNA to Preset.

This setting remains until changed again using this command, or until the hard drive is changed or reformatted.

To send this command using the VNA front panel, open the [GPIB Command Processor Console](#), then type either of the following examples at the command prompt. Then type the Query Syntax and press enter to be sure the VNA took the command.**Parameters**

<bool> Choose from:

- **ON** (or 1) - Trigger properties apply to ALL channels (Global).
Allows use of [CONT:SIGNal](#) command to configure the external trigger properties.
"Per Point" trigger property is not settable. Use the channel's [Point trigger](#) setting.
- **OFF** (or 0) - External Trigger properties apply to each channel independently.
 - Must use [TRIG:CHAN:AUX](#) commands to configure the external trigger properties. [CONT:SIGNal](#) will NOT work.
 - "Per Point" trigger output property is set using the channel's [Point trigger](#) setting **AND** [TRIG:CHAN:AUX:INTERval](#).

Examples

```
TRIG:PREF:AIGL 1
trigger:preference:aiglobal 0
```

Query Syntax TRIGger:PREFerece:AIGLobal?**Return Type** Boolean**Default** 0**TRIGger:READy:POLarity <char>****Applicable Models:** E5080A**(Read-Write)** Specifies the polarity of Ready for Trigger output.

All existing Ready for Trigger outputs are configured simultaneously with this command.

Parameters

<char> **LOW** - Outputs a TTL low when the VNA is ready for trigger.
HIGH - Outputs a TTL high when the VNA is ready for trigger.

Examples

```
TRIG:READ:POL HIGH
trigger:ready:polarity low
```

Query Syntax TRIGger:READy:POLarity?

Return Type Character

Default Low

[TRIGger\[:SEquence\]:SCOPE <char>](#)

Applicable Models: E5080A, M9485A

(Read-Write) Specifies whether a trigger signal is sent to all channels or only the current channel.

See [Triggering the VNA using SCPI](#).

Parameters

<char> Choose from:

- **ALL** - trigger signal is sent to all channels. Also sets [SENS:SWEep:TRIG:POINT OFF](#) on **ALL** channels.
- **CURRent** - trigger signal is sent to only one channel at a time. With each trigger signal, the channel is incremented to the next triggerable channel.
- **ACTive** - trigger signal is sent to only active channel at a time.

Examples `TRIG:SCOP ALL`
`trigger:sequence:scope current`

Query Syntax TRIGger[:SEquence]:SCOPE?

Return Type Character

Default ALL

[TRIGger\[:SEquence\]:SLOPE <char>](#)

Applicable Models: E5080A, M9485A

(Read-Write) Specifies the polarity expected by the external trigger input circuitry. Also specify [TRIG:TYPE](#) (Level |Edge).

See [Triggering the VNA using SCPI](#).

Parameters

<char> Choose from:

- **POSitive** (rising Edge) or High Level
- **NEGative** (falling Edge) or Low Level

Examples `TRIG:SLOP NEG`
`trigger:sequence:slope positive`

Query Syntax TRIGger[:SEquence]:SLOPE?

Return Type Character

Default POSitive

TRIGger[:SEQuence]:SOURce <char>

Applicable Models: E5080A, M9485A

(Read-Write) Sets the source of the sweep trigger signal. This command is a super-set of [INITiate:CONTinuous](#) which can NOT set the source to External.

See [Triggering the VNA using SCPI](#).

Parameters

<char> Choose from:

- **EXTernal** - external (rear panel) source.
- **IMMediate** - internal source sends continuous trigger signals
- **MANual** - sends one trigger signal when manually triggered from the front panel or [INIT:IMM](#) is sent.

Examples `TRIG:SOUR EXT`
`trigger:sequence:source immediate`

Query Syntax TRIGger[:SEQuence]:SOURce?

Return Type Character

Default IMMediate

TRIGger[:SEQuence]:TYPE <char>

Applicable Models: E5080A, M9485A

(Read-Write) Specifies the type of EXTERNAL trigger input detection used to listen for signals on the Meas Trig IN connectors. Edge triggers are most commonly used.

Parameters

<char> Choose from:

- EDGE** VNA responds to the rising and falling edge of a signal.
 - LEVel** VNA responds to a level (HIGH or LOW).
- Use [TRIG:SLOPe](#) to specify Rising or falling - High or Low.

Examples `TRIG:TYPE EDGE`
`trigger:sequence:type level`

Query Syntax TRIGger[:SEQuence]:TYPE?

Return Type Character

Default LEVel

E5080A

Last modified:

29-Sep-2015 First Release

Examples

Channels, Windows, and Measurements using SCPI

SOURCE and most **SENSE** commands act on the **channel** that is specified in the command. Channel 1 is default if not specified.

Most **DISPLAY** commands act on the **window and trace** specified in the command. Window1 and Trace1 are default if not specified.

CALCulate:MEASure commands act on the **trace** in the specified channel.

- CALCulate<channel number>:MEASure<meas number(trace number)>:xxxxxxx

The following program does the following:

- Presets the analyzer
- Create 2 windows
- Create 2 Measurements
- Change frequency ranges for channels
- Turn marker 1 ON for each measurement

To run this program, you need:

- An established [GPIB interface connection](#)

See Other SCPI Example Programs

Example

```
GPIB.Write "SYSTem:PReset"

'Create two windows
GPIB.Write ":DISPlay:SPLit 2"

'Create one trace on each window
GPIB.Write ":CALCulatel:PARAmeter:COUNT 1"
GPIB.Write ":CALCulate2:PARAmeter:COUNT 1"

'Define the parameter for each trace
GPIB.Write ":CALCulatel:MEASure1:PARAmeter 'S21'"
GPIB.Write ":CALCulate2:MEASure2:PARAmeter 'S12'"

'Change each channel's frequency range
GPIB.Write "SENSe1:FREQuency:SPAN 1e9"
GPIB.Write "SENSe2:FREQuency:SPAN 2e9"

'Turn marker 1 ON for each measurement
GPIB.Write "CALCulatel:MEASure1:MARKer:STATe ON"
GPIB.Write "CALCulate2:MEASure2:MARKer:STATe ON"
```

Create a Measurement using SCPI

This VBScript program creates a new S21 measurement and displays it on the VNA screen.

The SCPI commands in this example are sent over a COM interface using the SCPIStringParser object. You do NOT need a GPIB connection to run this example.

This VBScript (*.vbs) program can be run as a macro in the VNA. To do this, copy the following code into a text editor file such as Notepad and save it on the VNA hard drive as NewMeas.vbs. [Learn how to setup and run the macro.](#)

See Other SCPI Example Programs

Example

```
Dim app
Dim scpi
' Create / Get the VNA application.
Set app = CreateObject("AgilentPNA835x.Application")
Set scpi = app.ScpiStringParser

' A comment
'Preset the analyzer
scpi.Execute ("SYST:PREset")
'Define a measurement parameter
scpi.Execute ("CALCulate:MEASure1:PARAmeter 'S21'")
```

Getting and Putting Data using SCPI

This Excel VBA Program with VISA-COM does the following:

- Reads data from the analyzer
- Puts the data back into memory

To run this program, you need:

- An established [GPIB interface connection](#)

See Other SCPI Example Programs

Note: To change the read and write location of data, removing the comment from the beginning of ONE of the lines, and replace the comment in the beginning of the FDATA lines.

```

Sub SampleGetPutData()
    '*** The variables of the resource manager and the instrument I/O are
    declared.
    Dim ioMgr As VisaComLib.ResourceManager
    Dim GPIB As VisaComLib.FormattedIO488
    '*** The memory area of the resource manager and the instrument I/O are
    acquired.
    Set ioMgr = New VisaComLib.ResourceManager
    Set GPIB = New VisaComLib.FormattedIO488
    '*** Open the instrument.
    Set GPIB.IO = ioMgr.Open("GPIB0::16::INSTR")
    GPIB.IO.timeout = 10000

    Dim Numpts As Long
    Dim Datam As Variant

    'Select the measurement
    GPIB.WriteString "CALCulatel:MEASure1:PARAMeter 'S21'", True
    'Read the number of data points
    GPIB.WriteString "SENSel:SWEep:POINTs?", True
    Numpts = GPIB.ReadNumber
    'Turn continuous sweep off
    GPIB.WriteString "INITiate:CONTinuous OFF", True
    'Take a sweep
    GPIB.WriteString "INITiate1:IMMediate;*WAI", True
    'Ask for the Data
    'PICK ONE OF THESE LOCATIONS TO READ
    GPIB.WriteString "CALCulatel:MEASure1:DATA:FDATA?", True
        ' Formatted Meas
    'GPIB.WriteString "CALCulatel:MEASure1:DATA:FMEM?", True
        ' Formatted Memory
    'GPIB.WriteString "CALCulatel:MEASure1:DATA:SDATA?", True
        ' Corrected, Complex Meas
    'GPIB.WriteString "CALCulatel:MEASure1:DATA:SMEM?", True
        ' Corrected, Complex Memory
    'GPIB.WriteString "SENSel:CORrection:CSET:ETERm:DATA? 'Directivity(1,1)'",
    True ' Error-Term Directivity

    'Parse the data
    Datam = GPIB.ReadList(ASCIIType_R8, ",")

    'PUT THE DATA BACK IN
    GPIB.WriteString "CALCulatel:MEASure1:DATA:FDATA ", False

```

```
        ' Formatted Meas
' GPIB.WriteString "CALCulatel:MEASure1:DATA:FMEM ", False
        ' Formatted Memory
' GPIB.WriteString "CALCulatel:MEASure1:DATA:SDATA ", False
        ' Corrected, Complex Meas
' GPIB.WriteString "CALCulatel:MEASure1:DATA:SMEM ", False
        ' Corrected, Complex Memory
' GPIB.WriteString "SENSE1:CORREction:CSET:ETERm:DATA 'Directivity(1,1)',",
False ' Error-Term Directivity

GPIB.WriteList Datam, ASCIIType_R8, ",", True

'*** End procedure
GPIB.IO.Close
End Sub
```



Perform Guided ECal using SCPI

This VBScript program performs a Guided ECal Calibration. While this example is good to use as a starting point for Guided ECal, the Guided comprehensive cal example has some advanced features that are not in this program.

The SCPI commands in this example are sent over a COM interface using the SCPIStringParser object. You do NOT need a GPIB connection to run this example.

This VBScript (*.vbs) program can be run as a macro in the VNA. To do this, copy the following code into a text editor file such as Notepad and save it on the VNA hard drive as Guided.vbs. [Learn how to setup and run the macro.](#)

Example in VBScript

```
' Performing a 2-port cal (Ports 1 and 2)
Dim app
Dim scpi

' Create / Get the VNA application.
Set app = CreateObject("AgilentPNA835x.Application")
Set scpi = app.ScpiStringParser

' Specify the DUT connectors
' (for each connector of your DUT, one of the ECal module's ports must have
' that same connector, or else you cannot achieve the cal using that
' module).
scpi.Execute "sens:corr:coll:guid:conn:port1 ""APC 3.5 female"" "
scpi.Execute "sens:corr:coll:guid:conn:port2 ""APC 3.5 male"" "

' Note: If your VNA has more than 2 ports, you would need to uncomment
' one or both of these next two lines, to explicitly specify this is
' just a 2-port cal.
'scpi.Execute "sens:corr:coll:guid:conn:port3 ""Not used"" "
'scpi.Execute "sens:corr:coll:guid:conn:port4 ""Not used"" "
MsgBox "Connectors defined for Ports 1 and 2"

' Specify ECal modules
scpi.Parse "sens:corr:coll:guid:ckit:port1 'N4691-60004 ECal'"
scpi.Parse "sens:corr:coll:guid:ckit:port2 'N4691-60004 ECal'"
' Non-factory characterizations are specified as follows:
'scpi.Parse "sens:corr:coll:guid:ckit:port2 'N4691-60004 User 1 ECal'"
' When two or more ECal modules with the same model number are connected
' also specify the serial number as follows:
'scpi.Parse "sens:corr:coll:guid:ckit:port2 'N4691-60004 ECal 01234'"
' When Disk Memory ECal user characterizations are used,
' specify both the User char and the serial number as follows:
'scpi.Parse "sens:corr:coll:guid:ckit:port2 'N4691-60004 MyDskChar ECal
01234'"
'
MsgBox "Cal kits defined for Ports 1 and 2"

' Initiate the calibration and query the number of steps
scpi.Execute "sens:corr:coll:guid:init"
```



```

numSteps = scpi.Execute("sens:corr:coll:guid:steps?")
MsgBox "Number of steps is " + CStr(numSteps)

' Measure the standards
For i = 1 To numSteps
step = "Step " + CStr(i) + " of " + CStr(numSteps)
strPrompt = scpi.Execute("sens:corr:coll:guid:desc? " + CStr(i))
MsgBox strPrompt, vbOKOnly, step
scpi.Execute "sens:corr:coll:guid:acq STAN" + CStr(i)
Next

' Conclude the calibration
scpi.Execute "sens:corr:coll:guid:save"
MsgBox "Cal is done!"

```

Example in Excel VBA

```

Sub SampleEcal()
    '*** The variables of the resource manager and the instrument I/O are
    declared.
    Dim ioMgr As VisaComLib.ResourceManager
    Dim GPIB As VisaComLib.FormattedIO488
    '
    ' *** The memory area of the resource manager and the instrument I/O
    are acquired.
    Set ioMgr = New VisaComLib.ResourceManager
    Set GPIB = New VisaComLib.FormattedIO488
    '*** Open the instrument.
    Set GPIB.IO = ioMgr.Open("GPIB0::16::INSTR")
    GPIB.IO.timeout = 10000
    '
    ' Performing a 2-port cal (Ports 1 and 2)
    ' Specify the DUT connectors
    ' (for each connector of your DUT, one of the ECal module's ports must
    have
    ' that same connector, or else you cannot achieve the cal using that
    module).
    GPIB.WriteString "sens:corr:coll:guid:conn:port1 ""APC 3.5 female""",
    True
    GPIB.WriteString "sens:corr:coll:guid:conn:port2 ""APC 3.5 female""",
    True
    GPIB.WriteString "sens:corr:coll:guid:conn:port3 ""Not used""
    GPIB.WriteString "sens:corr:coll:guid:conn:port4 ""Not used""
    MsgBox "Connectors defined for Ports 1 and 2"
    '
    ' Specify ECal modules
    ' SENSE:CORR:COLL:GUID:CKIT:CAT? to read the list of available Ecal

```

```

module.

    GPIB.WriteString "sens:corr:coll:guid:ckit:port1 'N4431B ECal 03605'",
True
    GPIB.WriteString "sens:corr:coll:guid:ckit:port2 'N4431B ECal 03605'",
True
    '
    MsgBox "Cal kits defined for Ports 1 and 2"

    ' Initiate the calibration and query the number of steps
    GPIB.WriteString "sens:corr:coll:guid:init", True
    GPIB.WriteString "sens:corr:coll:guid:steps?", True
    numSteps = GPIB.ReadNumber
    MsgBox "Number of steps is " + CStr(numSteps)

    ' Measure the standards
    For i = 1 To numSteps
        step = "Step " + CStr(i) + " of " + CStr(numSteps)
        GPIB.WriteString "sens:corr:coll:guid:desc? " & CStr(i), True
        strPrompt = GPIB.ReadString
        MsgBox strPrompt, vbOKOnly, step
        GPIB.WriteString "sens:corr:coll:guid:acq STAN" & CStr(i), True
    Next

    ' Conclude the calibration
    GPIB.WriteString "sens:corr:coll:guid:save", True
    MsgBox "Cal is done!"

    '*** End procedure
    GPIB.IO.Close
End Sub

```

Last modified:

5-Apr-2011 edited for ECal options

Perform Guided Mechanical Cal using SCPI

This sample programs perform a Guided Calibration using Mechanical standards for a 2-port cal (Ports 1 and 2).

[Example in Excel VBA with VISA-COM](#)

```

Sub SampleGuidedCal2Port()
    '*** The variables of the resource manager and the instrument I/O are
    declared.
    Dim ioMgr As VisaComLib.ResourceManager
    Dim GPIB As VisaComLib.FormattedIO488
    '*** The memory area of the resource manager and the instrument I/O are
    acquired.
    Set ioMgr = New VisaComLib.ResourceManager
    Set GPIB = New VisaComLib.FormattedIO488
    '*** Open the instrument.
    Set GPIB.IO = ioMgr.Open("GPIB0::16::INSTR")
    GPIB.IO.timeout = 10000

    Dim numSteps As Integer, strPrompt As String

    ' Specify the DUT connectors
    GPIB.WriteString "sens:corr:coll:guid:conn:port1 ""APC 3.5 female""", True

    GPIB.WriteString "sens:corr:coll:guid:conn:port2 ""APC 3.5 male""", True
    ' Note: If your PNA has more than 2 ports, you would need to uncomment
    ' one or both of these next two lines, to explicitly specify this is
    ' just a 2-port cal.
    'gpiB.writestring "sens:corr:coll:guid:conn:port3 ""Not used"" ",True
    'gpiB.writestring "sens:corr:coll:guid:conn:port4 ""Not used"" ",True
    MsgBox "Connectors defined for Ports 1 and 2"
    ' Select the Cal Kit for each port being calibrated.
    GPIB.WriteString "sens:corr:coll:guid:ckit:port1 ""85052D""", True
    GPIB.WriteString "sens:corr:coll:guid:ckit:port2 ""85052D""", True
    MsgBox "Cal kits defined for Ports 1 and 2"
    ' Initiate the calibration and query the number of steps
    GPIB.WriteString "sens:corr:coll:guid:init"
    GPIB.WriteString "sens:corr:coll:guid:steps?"
    numSteps = GPIB.ReadNumber
    MsgBox "Number of steps is " + CStr(numSteps)
    ' Measure the standards
    'The following series of commands shows that standards
    'can be measured in any order. These steps acquire
    'measurement of standards in reverse order.
    'It is easiest to iterate through standards using
    'a For-Next Loop.
    For i = numSteps To 1 Step -1
        step = "Step " + CStr(i) + " of " + CStr(numSteps)
        GPIB.WriteString "sens:corr:coll:guid:desc? " + CStr(i)
        strPrompt = GPIB.ReadString
        MsgBox strPrompt, vbOKOnly, step
        GPIB.WriteString "sens:corr:coll:guid:acq STAN" + CStr(i), True
    Next
    ' Conclude the calibration
    GPIB.WriteString "sens:corr:coll:guid:save", True
    MsgBox "Cal is done!"

```

```

    **** End procedure
    GPIB.IO.Close
End Sub

```

Example in VB script

The following example is written in VB script.

The SCPI commands in this example are sent over a COM interface using the SCPIStringParser object. You do NOT need a GPIB connection to run this example.

This VBScript (*.vbs) program can be run as a macro in the VNA. To do this, copy the following code into a text editor file such as Notepad and save it on the VNA hard drive as Guided.vbs. [Learn how to setup and run the macro.](#)

```

Dim app
Dim scpi

' Create / Get the VNA application.
Set app = CreateObject("AgilentPNA835x.Application")
Set scpi = app.ScpiStringParser

' Specify the DUT connectors
scpi.Execute "sens:corr:coll:guid:conn:port1 ""APC 3.5 female"" "
scpi.Execute "sens:corr:coll:guid:conn:port2 ""APC 3.5 male"" "

' Note: If your VNA has more than 2 ports, you would need to uncomment
' one or both of these next two lines, to explicitly specify this is
' just a 2-port cal.
'scpi.Execute "sens:corr:coll:guid:conn:port3 ""Not used"" "
'scpi.Execute "sens:corr:coll:guid:conn:port4 ""Not used"" "
MsgBox "Connectors defined for Ports 1 and 2"

' Select the Cal Kit for each port being calibrated.
scpi.Execute "sens:corr:coll:guid:ckit:port1 ""85052D"" "
scpi.Execute "sens:corr:coll:guid:ckit:port2 ""85052D"" "
MsgBox "Cal kits defined for Ports 1 and 2"

' Initiate the calibration and query the number of steps
scpi.Execute "sens:corr:coll:guid:init"
numSteps = scpi.Execute("sens:corr:coll:guid:steps?")
MsgBox "Number of steps is " + CStr(numSteps)

' Measure the standards
'The following series of commands shows that standards
'can be measured in any order. These steps acquire
'measurement of standards in reverse order.
'It is easiest to iterate through standards using
'a For-Next Loop.
For i = numSteps To 1
step = "Step " + CStr(i) + " of " + CStr(numSteps)
strPrompt = scpi.Execute("sens:corr:coll:guid:desc? " + CStr(i))
MsgBox strPrompt, vbOKOnly, step
scpi.Execute "sens:corr:coll:guid:acq STAN" + CStr(i)
Next

' Conclude the calibration
scpi.Execute "sens:corr:coll:guid:save"
MsgBox "Cal is done!"

```

Setup Sweep Parameters using SCPI

This Visual Basic program sets up sweep parameters on the Channel 1 measurement. To run this program, you need:

- An established [GPIB interface connection](#)

See Other SCPI Example Programs

```
GPIB.Write "SYSTem:PRESet"  
'Select the measurement  
GPIB.Write "CALCulate:MEASure1:PARAmeter 'S21'"  
'Set sweep type to linear  
GPIB.Write "SENSE1:SWEep:TYPE LIN"  
  
'Set IF Bandwidth to 700 Hz  
GPIB.Write "SENSE1:BANDwidth 700"  
  
'Set Center and Span Freq's to 4 GHz  
GPIB.Write "SENSE1:FREQuency:CENTer 4ghz"  
GPIB.Write "SENSE1:FREQuency:SPAN 4ghz"  
  
'Set number of points to 801  
GPIB.Write "SENSE1:SWEep:POINTs 801"  
  
'Set sweep generation mode to Auto (Analog)  
GPIB.Write "SENSE1:SWEep:GENeration ANAL"  
  
'Set sweep time to Automatic  
GPIB.Write "SENSE1:SWEep:TIME:AUTO ON"  
  
'Query the sweep time  
GPIB.Write "SENSE1:SWEep:TIME?"  
SweepTime = GPIB.Read
```

Triggering the VNA using SCPI

To understand how to trigger the VNA using SCPI, it is very important to understand the [VNA trigger model](#). Here is a very simple explanation. These three separate functions control VNA triggering:

1. [Trigger:Source](#) - Where the trigger signals originate:
 - Internal Continuous
 - Internal Manual (Single)
 - External - a trigger source that is connected to the VNA rear panel.
2. [Trigger:Scope](#) - what gets triggered:
 - Global - each signal triggers all channels in turn.
 - Channel - each signal triggers ONE channel.
3. Channel settings ([Sense<ch>:Sweep:Mode](#)) How many triggers will each channel accept before going into hold.
 - HOLD - channel will not trigger.
 - CONTinuous - channel triggers indefinitely.
 - GROups - channel accepts the number of triggers specified with the last [SENS:SWE:GRO:COUN](#) <num>.
 - **SINGLE** - channel accepts ONE trigger, then goes to HOLD.
 - Point trigger [SENS1:SWE:TRIG:POINT](#)

When controlling the VNA using SCPI, a SINGLE trigger is used to ensure that a complete sweep is taken. This example demonstrates how to Single trigger the VNA using the following two methods:

- **Simplest Triggering**
 - This method uses the **default** Trigger Source = Internal to send a stream of trigger signals.
 - The channel is configured to ACCEPT only a single trigger signal, then HOLD ([Sense<ch>:Sweep:Mode SINGLE](#)). This is the ONLY required command.
 - This method can also be used when an External trigger source sends a continuous stream of trigger signals.
- **Advanced Triggering**
 - This method SENDS a single trigger from the Source, which can be from either Internal (using INIT:IMM) or External triggering.
 - Each channel is configured to accept an unlimited number of triggers. This method is the only way to perform point triggering.
 - When you require some channels to accept continuous triggers and other channels to accept single triggers, see [INIT:IMM Advanced](#) to learn how.

The SCPI commands in this example are sent over a COM interface using the SCPIStringParser object. You do NOT need a GPIB connection to run this example.

This VBScript (*.vbs) program can be run as a macro in the VNA. To do this, copy the following code into a text editor file such as Notepad and save it on the VNA hard drive as Trigger.vbs. [Learn how to setup and run the macro.](#)

Measurement setup example: This section of code can be used at the start of both methods. It sets up:

- S11 traces on two channels
- 10 data points
- Sweep time of 2 seconds - this is slow enough to allow us to watch as each trace is triggered.

```

Sub SampleTrigger()
'
'   *** The memory area of the resource manager and the instrument I/O
are acquired.
Set ioMgr = New VisaComLib.ResourceManager
Set GPIB = New VisaComLib.FormattedIO488
'*** Open the instrument.
Set GPIB.IO = ioMgr.Open("GPIB0::16::INSTR")
GPIB.IO.timeout = 10000

'Preset the analyzer
GPIB.WriteString "SYST:Preset", True
GPIB.WriteString ":DISPlay:SPLit 2", True
'Create one trace on each window
GPIB.WriteString ":CALCulatel:PARAMeter:COUNT 1", True
GPIB.WriteString ":CALCulate2:PARAMeter:COUNT 1", True
'Define the parameter for each trace
GPIB.WriteString ":CALCulatel:MEASure1:PARAMeter 'S11'", True
GPIB.WriteString ":CALCulate2:MEASure2:PARAMeter 'S22'", True
'set number of points to 10
GPIB.WriteString "SENS1:SWE:POIN 10", True
GPIB.WriteString "SENS2:SWE:POIN 10", True
'Set slow sweep so we can see
GPIB.WriteString "SENS1:SWE:TIME 2", True
GPIB.WriteString "SENS2:SWE:TIME 2", True
'=====
' Put both channels in Hold
GPIB.WriteString "SENS1:SWE:MODE HOLD", True
GPIB.WriteString "SENS2:SWE:MODE HOLD", True
'=====
'Pick Single Send or Single Accept
resp = MsgBox("Single Send? - Click No for Single Accept", vbYesNo,
"VNA Trigger Demo")
If resp = vbYes Then
    SingleSend
Else

```

```

        SingleAccept
    End If

    '*** End procedure
    GPIB.IO.Close
End Sub

```

Simple Triggering The following example sends a continuous stream of trigger signals and each VNA channel is set to ACCEPT only a signal trigger signal, then HOLD.

- This example can be used to configure External triggering where the trigger source sends a continuous stream of trigger signals. Configure the type of trigger signal that the VNA responds to using the [CONTrol:SIGNal](#) command. The command in this example sets the VNA to respond to HIGH TTL signals at the rear-panel BNC1 trigger IN connector. This command also automatically sets Trigger Source to External Trigger.
- The [TRIG SCOPE](#) (Global or Channel) setting is NOT necessary with a continuous stream of trigger signals. The example program directly controls when each channel is triggered.
- Point triggering can NOT be used with a continuous stream of trigger signals because in point triggering the channel will accept as many triggers as necessary to complete ONE full sweep. Use the [single SEND](#) example for point triggering.

```

Sub SingleAccept()
    'PNA sends continuous trigger signals
    GPIB.WriteString "TRIG:SOUR IMMEDIATE", True

    'Uncomment the following to set External triggering
    'gpiB.writestring"CONT:SIGN BNC1,TILHIGH", true
    AcceptOne
End Sub

Sub AcceptOne()
    'The following command makes the channel immediately sweep
    GPIB.WriteString "SENS1:SWE:MODE SINGLE", True

    '*OPC? allows the measurement to complete before the controller sends
    another command
    GPIB.WriteString "*OPC?", True
    Dmy = GPIB.ReadNumber
    ' You could do something to ch2 here before sweeping it
    GPIB.WriteString "SENS2:SWE:MODE SINGLE;*OPC?", True
    Dmy = GPIB.ReadNumber
    resp = MsgBox("Another trigger?", vbOKCancel, "VNA Trigger Demo")

```



```

If resp = vbOK Then
    AcceptOne
End If
End Sub

```

Advanced Trigger This example section performs Single Send triggering. Here, single triggering is accomplished by SENDING one trigger signal from the Trigger source and each channel is setup to accept unlimited trigger signals. See the [INIT:IMM](#) command for more details.

- Using this method, it is possible to change [Trigger:Scope](#) to Global or Channel. Set trigger scope to channel if there is some code to execute between channel measurements. Similarly, this method can be used to set [Point triggering](#). Use this method if there is some code to execute between data point measurements.
- In addition, this method can also be used to perform External triggering if the external trigger source is capable of SENDING single triggers. See the [CONTrol:SIGNal](#) command to set the type of signal to which the VNA will respond.
- If the external source can only send a continuous stream of trigger signals, then the [Single Accept](#) section must be used.

```

Sub SingleSend()
    'Set Source Internal - Manual Triggering
    GPIB.WriteString "TRIG:SOUR MANual", True
    'If using an External trigger source that is capable of
    'sending SINGLE trigger signals, then uncomment the following.
    'This command automatically sets trigger source to External
    '    gpib.writestring"CONT:SIGN BNC1,TILHIGH", true
    'Setup Trigger Scope
    'WHAT gets triggered
    'Pick one using comments
    'Set Channel triggering
    '    gpib.writestring"TRIG:SCOPE CURRENT", true
    'Set Global triggering (Default)
    GPIB.WriteString "TRIG:SCOPE ALL", True
    'Set Channel Settings
    'The channels respond to UNLIMITED trigger signals (Default)
    GPIB.WriteString "SENS1:SWE:MODE CONTinuous", True
    GPIB.WriteString "SENS2:SWE:MODE CONTinuous", True
    'To do Point trigger on one or more channels, uncomment the following.
    'Point trigger automatically sets Trig:Scope to Current/Channel
    '    gpib.writestring"SENS1:SWE:TRIG:POINT ON", true

```

```
'      gpib.writestring"SENS2:SWE:TRIG:POINT ON", true
  IntTrig
End Sub

Sub IntTrig()
  'If External triggering, replace this Sub with code
  'to single trigger the External Trig Source
  '*OPC? allows the measurement to complete before the controller sends
  another command
  GPIB.WriteString "INITiate:IMMediate;*OPC?", True
  Dmy = GPIB.ReadNumber
  resp = MsgBox("Another trigger?", vbOKCancel, "VNA Trigger Demo")
  If resp = vbOK Then
    IntTrig
  End If
End Sub
```

Last modified:

2015-09-29 First release

Upload and Download a Segment List

This program creates two segments, then uploads the segment data to the VNA.

The second part [downloads the segment list from the VNA](#).

[See all Segment SCPI commands](#).

Create and Upload a Segment List

Example in Excel VBA with VISA-COM

```

Sub SampleSegmentSetup()
    '*** The variables of the resource manager and the instrument I/O are
    declared.
    Dim ioMgr As VisaComLib.ResourceManager
    Dim GPIB As VisaComLib.FormattedIO488
    '
    '    *** The memory area of the resource manager and the instrument I/O
    are acquired.
    Set ioMgr = New VisaComLib.ResourceManager
    Set GPIB = New VisaComLib.FormattedIO488
    '*** Open the instrument.
    Set GPIB.IO = ioMgr.Open("GPIB0::16::INSTR")
    GPIB.IO.timeout = 10000

    Dim Buf As String * 100
    Dim srcPortNames As Variant
    Dim numberOfSrcPorts As Integer
    Dim segData As Variant
    Const numSegs = 2
    Const Chan = 1
    Const addIFBW_PWR = 0
    ' In case of a measurement receiver VNA like N5264A
    ' which has no source ports, "SOURCE:CATalog?" will
    ' return an empty list (just a pair of quotation marks)
    GPIB.WriteString "SOURCE:CATalog?", True
    Buf = GPIB.ReadString
    srcPortNames = Split(Buf, ",")
    If Left(srcPortNames(0), 2) = Chr(34) & Chr(34) Then
        numberOfSrcPorts = 0
    Else
        numberOfSrcPorts = UBound(srcPortNames) + 1
    End If
    ' Building up a string consisting of the sweep segment data
    ' we want to set up. This example will create two segments.
    ' Set state of first segment to be ON (1 = ON, 0 = OFF),
    ' 101 points, start freq of 10 MHz, stop freq of 1 GHz
    segData = "1,101,10E6,1E9"
    ' If you want to include one or more of: IFbandwidth, Dwell Time
    ' or Port Power, set Const addIFBW_PWR = 1

    If addIFBW_PWR = 1 Then
        GPIB.WriteString "SENSe" & Chan & ":SEGment:BWIDth:CONTROL ON"
        GPIB.WriteString "SENSe" & Chan & ":SEGment:SWEep:TIME:CONTROL ON"
        GPIB.WriteString "SENSe" & Chan & ":SEGment:POWER:CONTROL ON"
        ' Turning off coupling allows power to vary per each port

```

```

        GPIB.WriteString "SOURCE" & Chan & ":POWER:COUPLE OFF"
        segData = AddOptionalSettings(segData, numberOfSrcPorts)
    End If

    ' Set state of second segment to be ON, 201 points,
    ' start freq of 1 GHz, stop freq of 3 GHz

    segData = segData & ",1,201,1E9,3E9"

    ' Uncomment this line below only if you uncommented the
    ' AddOptionalSettings line above for the first segment.
    'segData = AddOptionalSettings(segData, numberOfSrcPorts)
    ' Upload our segment list to the channel
    GPIB.WriteString "SENSE1:SEGMENT:LIST SSTOP," & numSegs & "," & segData
    ' Set segment sweep type on Channel 1
    GPIB.WriteString "SENSE1:SWEep:TYPE SEGment"
    ' Having the PNA display the segment sweep table for the channel
    GPIB.WriteString "DISPlay:WINDow1:TABLE SEGment"

    '*** End procedure
    GPIB.IO.Close
End Sub
Function AddOptionalSettings(ByVal pStr As String, ByVal numSrcPorts As
Integer) As String
    Dim i

    ' Specifying 1 kHz IF bandwidth and Dwell Time of 0
    pStr = pStr & ", 1E3, 0"
    ' -10 dBm power for each of the source ports
    For i = 0 To numSrcPorts - 1
        pStr = pStr & ",-10"
    Next
    AddOptionalSettings = pStr
End Function

```

Example in VBScript

The SCPI commands in this example are sent over a COM interface using the SCPIStringParser object. You do NOT need a GPIB connection to run this example.

This VBScript (*.vbs) program can be run as a macro in the VNA. To do this, copy the following code into a text editor file such as Notepad and save it on the VNA hard drive as Unguided.vbs. [Learn how to setup and run the macro.](#)

```

Option Explicit
Dim app
Set app = CreateObject("AgilentPNA835x.Application")
' Preset the VNA
app.Preset
Dim scpi
Set scpi = app.ScpiStringParser
' In case of a measurement receiver VNA like N5264A
' which has no source ports, "SOURCE:CATALOG?" will
' return an empty list (just a pair of quotation marks)

```

```

Dim srcPortNames
srcPortNames = Split( scpi.Execute("SOURCE:CATalog?"), ",")
Dim numberOfSrcPorts
If Left( srcPortNames(0), 2 ) = Chr(34) & Chr(34) Then
    numberOfSrcPorts = 0
Else
    numberOfSrcPorts = UBound(srcPortNames) + 1
End If
' Building up a string consisting of the sweep segment data
' we want to set up. This example will create two segments.
Dim segData
' Set state of first segment to be ON (1 = ON, 0 = OFF),
' 101 points, start freq of 10 MHz, stop freq of 1 GHz
segData = "1,101,10E6,1E9"
' If you want to include one or more of: IFbandwidth, Dwell Time
' or Port Power, remove the comments from these next two lines
'TurnOnOptions 1 'Call the subroutine
'segData = AddOptionalSettings(segData, numberOfSrcPorts)
' Set state of second segment to be ON, 201 points,
' start freq of 1 GHz, stop freq of 3 GHz
segData = segData & ",1,201,1E9,3E9"
' Uncomment this line below only if you uncommented the
' AddOptionalSettings line above for the first segment.
'segData = AddOptionalSettings(segData, numberOfSrcPorts)
Const numSegs = 2
' Upload our segment list to the channel
scpi.Execute "SENSE1:SEGMENT:LIST SSTOP," & numSegs & "," & segData
' Set segment sweep type on Channel 1
scpi.Execute "SENSE1:SWEep:TYPE SEGment"
' Having the VNA display the segment sweep table for the channel
scpi.Execute "DISPlay:WINDow1:TABLE SEGment"
Sub TurnOnOptions(ByVal chan)
    scpi.Execute "SENSe"&chan&":SEGMENT:BWIDth:CONTRol ON"
    scpi.Execute "SENSe"&chan&":SEGMENT:SWEep:TIME:CONTRol ON"
    scpi.Execute "SENSe"&chan&":SEGMENT:POWEr:CONTRol ON"
    ' Turning off coupling allows power to vary per each port
    scpi.Execute "SOURCE"&chan&":POWEr:COUPlE OFF"
End Sub
Function AddOptionalSettings(ByVal inStr, ByVal numSrcPorts)

```

```

' Specifying 1 kHz IF bandwidth and Dwell Time of 0
inStr = inStr & ",1E3,0"
' -10 dBm power for each of the source ports
Dim i
For i = 0 To numSrcPorts - 1
    inStr = inStr & ",-10"
Next
AddOptionalSettings = inStr
End Function

```

Download a Segment List

This example assumes that the active trace is in Window 1

```

Option Explicit
Dim app
Set app = CreateObject("AgilentPNA835x.Application")
Dim scpi
Set scpi = app.ScpiStringParser
' Set the display-active channel's sweep type to segment sweep
' (if the VNA's currently active measurement window doesn't
' contain any traces, this querying for active channel will
' result in a SCPI error which scpi.Parse will trap and throw)
Dim chan
chan = CLng( scpi.Parse("SYSTem:ACTive:CHANnel?") )
scpi.Execute "SENSe"&chan&":SWEep:TYPE SEGment"
' Having the VNA display the segment sweep table for the channel
scpi.Execute "DISPlay:WINDow1:TABLE SEGment"
' Get the total number of segments
Dim numSegs
numSegs = CLng( scpi.Execute("SENSe"&chan&":SEGment:COUNT?") )
' Read the segment listing
Dim segDataStr
segDataStr = scpi.Execute("SENSe"&chan&":SEGment:LIST?")
Dim segData
segData = Split(segDataStr, ",")
' Get upper bound of the array of data values
' (lower bound of array resulting from VB 'Split' function is 0)
Dim segArrayUB
segArrayUB = UBound(segData)

```

```

Dim numDataElementsPerSeg
numDataElementsPerSeg = (segArrayUB + 1) / numSegs
WScript.Echo "Number of segments = " & numSegs
WScript.Echo "Number of data values per segment = " & numDataElementsPerSeg
Dim segInfStr
segInfStr = "Segment 1: state = " & CBool(segData(0))
segInfStr = segInfStr & ", num points = " & CLng(segData(1))
segInfStr = segInfStr & ", start freq = " & CDb1(segData(2))
segInfStr = segInfStr & ", stop freq = " & CDb1(segData(3))
segInfStr = segInfStr & ", IFBW = " & CDb1(segData(4))
segInfStr = segInfStr & ", dwell time = " & CDb1(segData(5))
' In case of a measurement receiver VNA like N5264A
' which has no source ports, "SOURce:CATalog?" will
' return an empty list
Dim srcPortNames
srcPortNames = Split( scpi.Execute("SOURce"&chan&":CATalog?"), ",")
Dim srcPortNamesUB
srcPortNamesUB = UBound(srcPortNames)
' First source port name will be preceded by a quotation mark
' and the last name will be followed by one of those, so stripping
' those off now.
srcPortNames(0) = Right( srcPortNames(0), Len(srcPortNames(0)) - 1 )
srcPortNames(srcPortNamesUB) = Left( srcPortNames(srcPortNamesUB),
InStrRev(srcPortNames(srcPortNamesUB), Chr(34)) - 1 )
Dim firstPortIndex
firstPortIndex = 6
Dim lastPortIndex
lastPortIndex = numDataElementsPerSeg - 1
Dim j
For j = firstPortIndex To lastPortIndex
    segInfStr = segInfStr & ", " & srcPortNames(j - firstPortIndex) & "
    power = " & CDb1(segData(j))
Next
WScript.Echo segInfStr

```

Concepts

GPIB Fundamentals

The General Purpose Interface Bus (GPIB) is a system of hardware and software that allows you to control test equipment to make measurements quickly and accurately. This topic contains the following information:

- [The GPIB Hardware Components](#)
- [The GPIB / SCPI Programming Elements](#)
- [Specifications](#)
- [GPIB Interface Capability Codes](#)

Note: All of the topics related to programming assume that you already know how to program, preferably using a language that can control instruments.

Other Topics about GPIB Concepts

The GPIB Hardware Components

The system bus and its associated interface operations are defined by the IEEE 488 standard. The following sections list and describe the main pieces of hardware in a GPIB system:

Controllers

Controllers specify the instruments that will be the talker and listener in a data exchange. The controller of the bus must have a GPIB interface card to communicate on the GPIB.

- The **Active Controller** is the computer or instrument that is currently controlling data exchanges.
- The **System Controller** is the only computer or instrument that can take control and give up control of the GPIB to another computer or instrument, which is then called the active controller.

Talker / Listener Instruments and GPIB Addresses

- **Talkers** are instruments that can be addressed to send data to the controller.
- **Listeners** are instruments that can be addressed to receive a command, and then respond to the command. All devices on the bus are required to listen.

Every GPIB instrument must have its own unique address on the bus. The VNA address (default = 716) consists of two parts:

1. **The Interface select code** (typically 7) indicates which GPIB port in the system controller is used to communicate with the device.
2. **The primary address** (16) is set at the factory. You can change the primary address of any device on the bus to any number between 0 and 30. To change the analyzer address click [System / Configure / SICL-GPIB](#).

A secondary address is sometimes used to allow access to individual modules in a modular instrument system, such as a VXI mainframe. The VNA does NOT have a secondary address.

Cables

GPIB Cables are the physical link connecting all of the devices on the bus. There are eight data lines in a GPIB cable that send data from one device to another. There are also eight control lines that manage traffic on the data lines and control other interface operations.

You can connect instruments to the controller in any arrangement with the following limitations:

- Do not connect more than 15 devices on any GPIB system. This number can be extended with the use of a bus extension.
- Do not exceed a total of 20 meters of total cable length or 2 meters per device, whichever is less.
- Avoid stacking more than three connectors on the back panel of an instrument. This can cause unnecessary strain on the rear-panel connector.

The GPIB / SCPI Programming Elements

The following software programming elements combine to become a GPIB program:

- [GPIB / SCPI Commands](#)
- [Programming Statements](#)
- [Instrument Drivers](#)

GPIB Commands

The GPIB command is the basic unit of communication in a GPIB system. The analyzer responds to three types of GPIB commands:

1. IEEE 488.1 Bus-management Commands

These commands are used primarily to tell some or all of the devices on the bus to perform certain interface operations.

All of the functions that can be accomplished with these commands can also be done with IEEE 488.2 or SCPI commands. Therefore, these commands are not documented in this Help system. For a complete list of IEEE 488.1 commands refer to the IEEE 488 standard. **Examples** of IEEE 488.1 Commands

- **CLEAR** - Clears the bus of any pending operations
- **LOCAL** - Returns instruments to local operation

2. IEEE 488.2 Common Commands

These commands are sent to instruments to perform interface operations. An IEEE 488.2 common command consists of a single mnemonic and is preceded by an asterisk (*). Some of the commands have a query form which adds a "?" after the command. These commands ask the instrument for the current setting. See a complete list of the [Common Commands](#) that are recognized by the analyzer.

Examples of IEEE 488.2 Common Commands

- *OPC - Operation Complete
- *RST - Reset
- *OPT? - Queries the option configuration

3. SCPI Commands

The Standard Commands for Programmable Instruments (SCPI) is a set of commands developed in 1990. The standardization provided in SCPI commands helps ensure that programs written for a particular SCPI instrument are easily adapted to work with a similar SCPI instrument. SCPI commands tell instruments to do device specific functions. For example, SCPI commands could tell an instrument to make a measurement and output data to a controller. **Examples** of SCPI Commands:

```
CALCULATE:AVERAGE:STATE ON
```

SENSE:FREQUENCY:START?

For more information on SCPI:

- [The Rules and Syntax of SCPI Commands](#) provides more detail of the SCPI command structure.
- [SCPI Command Tree](#) is a complete list of the SCPI commands for the analyzer

Programming Statements

SCPI commands are included with the language specific I/O statements to form program statements. The programming language determines the syntax of the programming statements. SCPI programs can be written in a variety of programming languages such as VEE, HP BASIC, or C++. **Example** of a Visual Basic statement:

- `GPIB.Write "SOURCE:FREQUENCY:FIXED 1000 MHz"`

Note about examples**Instrument Drivers**

Instrument drivers are subroutines that provide routine functionality and can be reused from program to program. GPIB industry leaders have written standards for use by programmers who develop drivers. When programmers write drivers that comply with the standards, the drivers can be used with predictable results. To comply with the standard, each instrument driver must include documentation describing its functionality and how it should be implemented.

GPIB Specifications

Interconnected devices - Up to 15 devices (maximum) on one contiguous bus.

Interconnection path - Star or linear (or mixed) bus network, up to 20 meters total transmission path length or 2 meters per device, whichever is less.

Message transfer scheme - Byte-serial, bit-parallel, asynchronous data transfer using an interlocking 3-wire handshake.

Maximum data rate - 1 megabyte per second over limited distances, 250 to 500 kilobytes per second typical maximum over a full transmission path. The devices on the bus determine the actual data rate.

Address capability - Primary addresses, 31 Talk and 31 Listen; secondary addresses, 961 Talk and 961 Listen. There can be a maximum of 1 Talker and up to 14 Listeners at a time on a single bus. See also previous section on [GPIB addresses](#).

GPIB Interface Capability Codes

The IEEE 488.1 standard requires that all GPIB compatible instruments display their interface capabilities on the rear panel using codes. The codes on the analyzer, and their related descriptions, are listed below:

SH1 full source handshake capability

AH1 full acceptor handshake capability

T6 basic talker, serial poll, no talk only, unaddress if MLA (My Listen Address)

TE0 no extended talker capability

L4 basic listener, no listen only, unaddress if MTA (My Talk Address)

LEO no extended listener capability

SR1 full service request capability

RL1 full remote / local capability

PPO **no parallel poll capability**

DC1 full device clear capability

DT1 full device trigger capability

C1 system controller capability

C2 send IFC (Interface Clear) and take charge controller capability

C3 send REN (Remote Enable) controller capability

C4 respond to SRQ (Service Request)

The Rules and Syntax of SCPI

Most of the commands used for controlling instruments on the GPIB are SCPI commands. The following sections will help you learn to use SCPI commands in your programs.

- [Branches on the Command Tree](#)
- [Command and Query](#)
- [Multiple Commands](#)
- [Command Abbreviation](#)
- [Bracketed \(Optional\) Keywords](#)
- [Vertical Bars \(Pipes\)](#)
- [MIN and MAX Parameters](#)

Other Topics about GPIB Concepts

Branches on the Command Tree

All major functions on the analyzer are assigned keywords which are called ROOT commands. (See GPIB Command Finder for a list of SCPI root commands). Under these root commands are branches that contain one or more keywords. The branching continues until each analyzer function is assigned to a branch. A root command and the branches below it is sometimes known as a subsystem.

For example, under [SOURce:POWer](#) are several branch commands.

Sometimes the same keyword, such as `STATE`, is used in several branches of the command tree. To keep track of the current branch, the analyzer's command parser uses the following rules:

- **Power On and Reset** - After power is cycled or after `*RST`, the current path is set to the root level commands.
- **Message Terminators** - A message terminator, such as a `<NL>` character, sets the current path to the root command level. Many programming language output statements send message terminators automatically. Message terminators are described in Sending Messages to the Analyzer.
- **Colon (:)** - When a colon is between two command keywords, it moves the current path down one level in the command tree. For example, the colon in `:SOURCE:POWER` specifies that `POWER` is one level below `SOURCE`. When the colon is the first character of a command, it specifies that the following keyword is a root level command. For example, the colon in `:SOURCE` specifies that `source` is a root level command.

Note: You can omit the leading colon if the command is the first of a new program line. For example, the following two commands are equivalent:

```
SOUR:POW:ATT:AUTO
:SOUR:POW:ATT:AUTO
```

- **<WSP>** - Whitespace characters, such as `<tab>` and `<space>`, are generally ignored. There are two important exceptions:
 - Whitespace inside a keyword, such as `:CALC U LATE`, is not allowed.
 - Most commands end with a parameter. You must use whitespace to separate these ending parameters from commands. **Always refer to the command documentation.** In the following example, there is whitespace between `STATE` and `ON`.

```
CALCULATE1:SMOOTHING:STATE ON
```

- **Comma (,)** - If a command requires more than one parameter, you must separate adjacent parameters using a comma. For example, the `SYSTEM:TIME` command requires three values to set the analyzer clock: one for hours, one for minutes, and one for seconds. A message to set the clock to 8:45 AM would be `SYSTEM:TIME 8,45,0`. Commas do not affect the current path.
- **Semicolon(;)** - A semicolon separates two commands in the same message without changing the current path. See [Multiple Commands](#) later in this topic.
- **IEEE 488.2 Common Commands** - Common commands, such as `*RST`, are not part of any subsystem. An instrument interprets them in the same way, regardless of the current path setting.

Command and Query

A SCPI command can be an Event command, Query command (a command that asks the analyzer for information), or both. The following are descriptions and examples of each form of command. GPIB Command Finder lists every SCPI command that is recognized by the analyzer, and its form.

Form

Examples

Event commands - cause an action to occur inside the analyzer.

```
:INITIATE:IMMEDIATE
```

Query commands - query only; there is no associated analyzer state to set.

```
:SYSTEM:ERROR?
```

Command and query - set or query an analyzer setting. The query form appends a question mark (?) to the set form

```
:FORMAt:DATA ! Command
:FORMAt:DATA? ! Query
```

Multiple Commands

You can send multiple commands within a single program message. By separating the commands with semicolons the current path does not change. The following examples show three methods to send two commands:

1. Two program messages:

```
SOURCE:POWER:START 0DBM
SOURCE:POWER:STOP 10DBM
```

2. **One long message.** A colon follows the semicolon that separates the two commands causing the command parser to reset to the root of the command tree. As a result, the next command is only valid if it includes the entire keyword path from the root of the tree:

```
SOURCE:POWER:START 0DBM;:SOURCE:POWER:STOP 10DBM
```

3. **One short message.** The command parser keeps track of the position in the command tree. Therefore, you can simplify your program messages by including only the keyword at the same level in the command tree.

```
SOURCE:POWER:START 0DBM;STOP 10DBM
```

Common Commands and SCPI Commands

You can send Common commands and SCPI commands together in the same message. (For more information on these types of commands see [GP-IB Fundamentals](#).) As in sending multiple SCPI commands, you must separate them with a semicolon.

Example of Common command and SCPI commands together

```
*RST;SENSE:FREQUENCY:CENTER 5MHZ;SPAN 100KHZ
```

Command Abbreviation

Each command has a long form and an abbreviated short form. The syntax used in this Help system use uppercase characters to identify the short form of a particular keyword. The remainder of the keyword is lower case to complete the long form.

```
SOUR - Short form
SOURce - Long form
```

Either the complete short form or complete long form must be used for each keyword. However, the keywords used to make a complete SCPI command can be a combination of short form and long form.

The following is **unacceptable** - The first three keywords use neither short or long form.

```
SOURc:POwe:Atten:Auto on
```

The following is **acceptable** - All keywords are either short form or long form.

```
SOUR:POWER:ATT:AUTO on
```

In addition, the analyzer accepts lowercase and uppercase characters as equivalent as shown in the following equivalent commands:

```
source:POW:att:auto ON
Source:Pow:Att:Auto on
```

Optional [Bracketed] Keywords

You can omit some keywords without changing the effect of the command. These optional, or default, keywords are used in many subsystems and are identified by brackets in syntax diagrams.

Example of Optional Keywords

The `HCOPY` subsystem contains the optional keyword `IMMEDIATE` at its first branching point. Both of the following commands are equivalent:

```
"HCOPY:IMMEDIATE"
"HCOPY"
```

The syntax in this Help system looks like this:

```
HCOPY[:IMMEDIATE]
```

Vertical Bars | Pipes

Vertical bars, or "pipes", can be read as "**or**". They are used in syntax diagrams to separate alternative parameter options.

Example of Vertical Bars:

```
SOURce:POWER:ATTenuation:AUTO <on|off>
```

Either `ON` or `OFF` is a valid parameter option.

MIN and MAX Parameters

The special form parameters "`MINimum`" and "`MAXimum`" can be used with commands that specify single frequency (Hz) and time (seconds) as noted in the command documentation. **Note:** Also with these commands, `KHZ`, `MHz`, and `GHz` are accepted as suffixes/units.

The short form (`min`) and long form (`minimum`) of these two keywords are equivalent.

- **MAXimum** refers to the largest value that the function can currently be set to
- **MINimum** refers to the smallest value that the function can currently be set to.

For example, the following command sets the start frequency to the smallest value that is currently possible:

```
SENS:FREQ:START MIN
```

In addition, the max and min values can also be queried for these commands.

For example, the following command returns the smallest value that Start Frequency can currently be set to:

```
SENS:FREQ:START? MIN
```

E5080A

An error will be returned if a numeric parameter is sent that exceeds the MAX and MIN values.

For example, the following command will return an "Out of range" error message.

```
SENS:FREQ:START 1khz
```



Configure for Remote Control

The following settings are used to configure the VNA for remote control using SCPI commands.

How to Configure for SICL / GPIB Operation

Using **Hardkey/SoftTab/Softkey**

1. Press **System** > **System Settings** > **SICL/GPIB...**

◀ **Programming Commands** ▶

SICL / GPIB / SCPI dialog box help

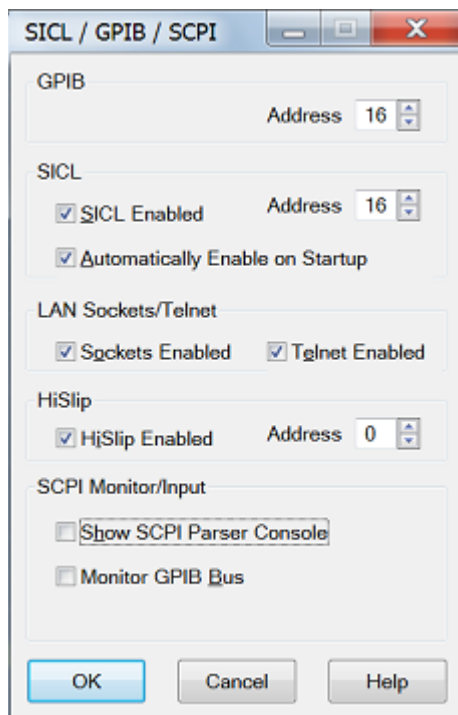

GPIB

Address Sets the VNA address used to send and receive GPIB/SCPI commands to the system controller (external computer).

Use the National Instruments interface or the Keysight (Agilent) Connection Expert interface to change the System Controller address. Use the VNA as the system controller of external devices. Learn about the [VNA as controller](#).

SICL

SICL Enabled When checked, the analyzer is capable of running GPIB programs on its computer to control analyzer functions. The programs must be run from a GPIB-capable programming environment (VEE, Visual Basic). This mode does not allow control of external GPIB instruments.

To uncheck this box, exit the VNA application - (Click File, then Exit). The VNA restarts with the SICL enabled box unchecked unless **Automatically Enable on Startup** is checked.

Learn more about [Configuring for VISA and SICL](#).

Address Sets the VNA address.

Automatically Enable on Startup When checked, SICL Enabled is automatically selected when starting the VNA application.

LAN Sockets/Telnet

Provides ability to communicate with the VNA from a PC that uses a Windows, or non-Windows, operating system.

- These settings are checked by default. If you have security concerns, clear these check boxes.
- These settings remain after the VNA is shutdown and restarted.

Sockets Enabled When checked, provides the ability to control the VNA from a remote SCPI program using port number 5025. See the C# example that illustrates how this is done.

Telnet Enabled When checked, provides the ability to send single SCPI commands from a remote Windows, or non-Windows, PC to the VNA using port number 5024.

How to send single SCPI commands using Telnet:

1. On the remote PC, click **Start**, then **Run**
2. Type: **telnet** <computer name> **5024**
where <computer name> is the full computer name of the VNA. See how to find the computer name of the VNA.
3. A Telnet window with a **SCPI>** prompt should appear on the remote PC screen.
4. From the SCPI prompt:
 - Type single SCPI commands
 - If an invalid SCPI command is sent, the prompt will disappear. Press **Enter** or **Ctrl C** to recover the SCPI prompt.
 - To exit the telnet window click **X** in the upper-right corner.
 - To get a normal telnet prompt, press **Ctrl]** (closing bracket).
 - To close the normal telnet window, type **Quit** and press **Enter**.

HiSLIP

HiSLIP has the same functionality as VXI 11 (SICL) with better performance. Therefore, it is enabled by default on the VNA.

Address 0 by default. No change is necessary for the VNA.

On the remote computer, use address string TCPIP0::::hislip<address>. ("hislip" is case-sensitive).

SCPI Monitor / Input

Show SCPI Parse Console Launches a window that is used to send single SCPI/GPIB commands.

Note: The Status Register system can NOT be used from the GPIB Console.

- Type a valid command, with appropriate arguments and press enter.
- Use the arrow keys to recall previous commands.
- The console window may launch behind the VNA application. Press **Control+Tab** to bring the console window to the top.

Monitor GPIB Bus Enables monitoring activity on the GPIB.

Local and Remote Operation

The analyzer **LCL** and **RMT** (Local and Remote) operation labels appear in the lower right corner of the status bar.

Note: The status bar is NOT visible when the analyzer is preset. See [how to make the status bar visible](#).

- **LCL** appears when NOT under SCPI control
- **RMT** appears when under SCPI control. Remote operation disables the front panel keys except for the **Macro/Local** key.

To return to Local (front panel) operation, press the Macro / Local key

Sending the GPIB "GTL" (go to local) command also returns the analyzer to Local operation.

Sending the GPIB "LLO" (local lockout) command disables the front panel Local button.

Last Modified:

10-Oct-2014 First Release

5-Mar-2015 Add PXI

Getting Data from the Analyzer

Data is sent from the analyzer in response to program queries. Data can be short response messages, such as analyzer settings, or large blocks of measurement data. This topic discusses how to read query responses and measurement data from the analyzer in the most efficient manner.

- [Response Message Syntax](#)
- [Clearing the Output Queue](#)
- [Response Data Types](#)
- [Transferring Measurement Data](#)

Note: Some PCs use a modification of the IEEE floating point formats with the byte order reversed. To reverse the byte order for data transfer into a PC, use the [FORMat:BOReR](#) command.

Other Topics about GPIB Concepts

Response Message Syntax

Responses sent from the analyzer contain data, appropriate punctuation, and message terminators.

<NL><^END> is always sent as a response message terminator. Most programming languages handle these terminators transparent to the programmer.

Response messages use commas and semicolons as separators in the following situations:

- a comma separates response data items when a single query command returns multiple values

```
FORM:DATA? 'Query
ASC, +0 'Analyzer Response
```

- a semicolon separates response data when multiple queries are sent within the same messages

```
SENS:FREQ:STAR?;STOP? --Example Query
+1.23000000000E+008; +7.89000000000E+008<NL><^END> 'Analyzer Response
```

Clearing the Output Queue

After receiving a query, the analyzer places the response message in its output queue. Your program should read the response immediately after the query is sent. This ensures that the response is not cleared before it is read. The response is cleared when one of the following conditions occur:

- When the query is not properly terminated with an ASCII carriage return character or the GPIB <^END> message.
- When a second program query is sent.
- When a program message is sent that exceeds the length of the input queue
- When a response message generates more response data than fits in the output queue.
- When the analyzer is switched ON.

Response Data Types

The analyzer sends different response data types depending on the parameter being queried. You need to know the type of data that will be returned so that you can declare the appropriate type of variable to accept the data. For more information on declaring variables see your programming language manual. The GPIB Command Finder lists every GPIB command and the return format of data in response to a query. The analyzer returns the following types of data:

- [Numeric Data](#)
- [Character Data](#)
- [String Data](#)
- [Block Data](#)

Numeric Data

All numeric data sent over the GPIB is ASCII character data. Your programming environment may convert the character data to numeric data for you. Boolean data (1 | 0) is a type of numeric data.

Character Data

Character data consists of ASCII characters grouped together in mnemonics that represent specific analyzer settings. The analyzer always returns the short form of the mnemonic in upper-case alpha characters. Character data looks like string data. Therefore, refer to the GPIB Command Finder to determine the return format for every command that can be queried.

Example of Character Data

```
MLOG
```

String Data

String data consists of ASCII characters. String parameters can contain virtually any set of ASCII characters. When sending string data to the analyzer, the string **must** begin with a single quote (') or a double quote (") and end with the same character (called the delimiter).

Note: The analyzer responds best to all special characters if the string is enclosed in single quotes. If quotes are not used, the analyzer will convert the text to uppercase. The analyzer may not respond as you expect.

The analyzer always encloses data in double quotes when it returns string data.

Example of String Data

```
GPIB.Write "DISP:WINDow:TITLe:DATA?"
```

```
"This is string response data."
```

Block Data

Block data is used to transfer measurement data. Although the analyzer will accept either definite length blocks or indefinite length blocks, it always returns definite length block data in response to queries unless the specified format is ASCII. The following graphic shows the syntax for definite block data:

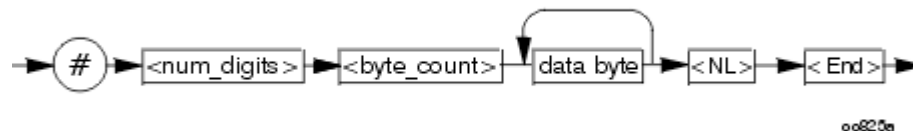

<num_digits> specifies how many digits are contained in <byte_count>

<byte_count> specifies how many data bytes will follow in <data bytes>

Example of Definite Block Data

```
#210ABCDE+WXYZ<nl><end>
```

Where:

- # - always sent before definite block data
- 2 - specifies that the byte count is two digits (2)
- 10 - specifies the number of data bytes that will follow, not counting <NL><END>
- ABCDE+WXYZ - 10 digits of data
- <NL><END> - always sent at the end of block data

Transferring Measurement Data

Measurement data is blocks of numbers that result from an analyzer measurement. Measurement data is available from various processing arrays within the analyzer. For more information on the analyzer's data processing flow, see [Accessing Data Map](#). Regardless of which measurement array is read, transferring measurement data is done the same.

See an example.

When transferring measurement data, the [FORMat:DATA](#) command allows you to choose from the following two data types:

- REAL
- ASCII

The following graphic shows the differences in transfer times between the two:

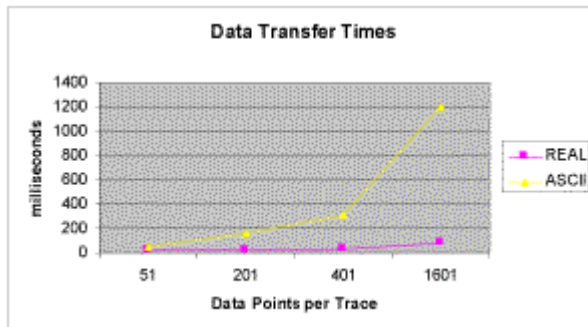

REAL Data

REAL data (also called floating-point data) types transfer faster. This is because REAL data is binary and takes about half the space of ASCII data. The disadvantage of using REAL data is that it requires a header that must be read. See [definite length block data](#). The binary floating-point formats are defined in the IEEE 754-1985 standard. The following choices are available in REAL format:

- **REAL,32** - IEEE 32-bit format - single precision (not supported by HP BASIC)
- **REAL,64** - IEEE 64-bit format - double precision

ASCII Data

The easiest and slowest way to transfer measurement data is to use ASCII data. ASCII data is sent if the data contains both numbers and characters (the setting of FORMat:DATA is ignored). ASCII data is separated by commas.

Last Modified:

10-Oct-2014 First Release



Synchronizing the VNA and Controller

Synchronizing the VNA and Controller means to keep VNA and the controller working at approximately the same pace. In this topic:

- [The Problem and the Solution](#)
- [VNA Queues](#)
- [Synchronization Methods](#)
- [When To Synchronize the Analyzer and Controller](#)
 - [Completion of a Measurement](#)
 - [Measurements with External Trigger](#)
 - [Averaged Measurements](#)
 - [During Calibration Acquire](#)

See Also

- Synchronize an External PSG Source
- [Triggering the VNA using SCPI](#)

The Problem

The controller sends commands to the VNA as fast as the GPIB bus will allow. The VNA stores these commands in the VNA [Input queue](#). However, the VNA executes those commands at a slower rate than they are accepted. If left unchecked, the VNA input buffer will contain a long list of commands waiting to be executed.

At some point, the controller will send a query command which requires a response from the VNA. The controller will not send more commands until a response is received. It will wait for a response from the VNA for the amount of time set by the Timeout setting. If the VNA is working off a long list of commands in the input buffer, it may not execute and respond to the query command until the controller has quit waiting, or "timed out".

The Solution

The easiest way to keep the controller and the VNA "synched" is to send query commands often. This stops the controller from sending more commands until the VNA executes and responds to the query. This limits the number of commands that are waiting in the VNA input queue to be processed.

Although any query will stop the controller from sending more commands, a good practice is to send [*OPC?](#) Most of the time, as soon as this query is executed, the VNA will immediately reply. The exception to this is the Overlapped command.

- **Sequential** commands are executed quickly and in the order in which they are received.
- **Overlapped** (also known as Asynchronous) commands take longer to execute. Therefore, they allow the VNA to execute other commands while waiting. However, the programmer may want to prevent the analyzer from processing new commands until the overlapped command has completed. If the VNA is executing an overlapped command when a [*OPC?](#) is received, it will wait until the overlapped command is complete before processing new commands.

Note: The analyzer has two overlapped commands:

- [INITiate:IMMediate](#)
- [SENSe:SWEep:MODE GROUPS](#) (when INIT:CONT is ON)

Several calibration commands have an optional ASYNchronous argument which allows them to behave like overlapped commands. [Learn more.](#)

Analyzer Queues

Queues are memory buffers that store messages until they can be processed. The analyzer has the following queues:

- [Input Queue](#)
- [Output Queue](#)
- [Error Queue](#)

Input Queue

The controller sends statements to the analyzer without regard to the amount of time required to execute the statements. The input queue is very large (31k bytes). It temporarily stores commands and queries from the controller until they are read by the analyzer's command parser. The input queue is cleared when the analyzer is switched ON.

Output Queue

When the analyzer parses a query, the response is placed in the output queue until the controller reads it. Your program should immediately read the response or it may be cleared from the output queue. The following conditions will clear a query response:

- When a second query is sent before reading the response to the first. This does not apply when multiple queries are sent in the same statement.
- When a program statement is sent that exceeds the length of the input queue.
- When a response statement generates more data than fits in the output queue.
- When the analyzer is switched ON.

Error Queue

Each time the analyzer detects an error, it places a message in the error queue. When the `SYSTEM:ERROR?` query is sent, one message is moved from the error queue to the output queue so it can be read by the controller. Error messages are delivered to the output queue in the order they were received. The error queue is cleared when any of the following conditions occur:

- When the analyzer is switched ON.
- When the `*CLS` command is sent to the analyzer.
- When all of the errors are read.

If the error queue overflows, the last error is replaced with a "Queue Overflow" error. The oldest errors remain in the queue and the most recent error is discarded.

Synchronization Methods

The following common commands are used to synchronize the analyzer and controller. Examples are included that illustrate the use of each command in a program. See the SCPI command details to determine if a command is an overlapped command.

- [*WAI](#)
- [*OPC?](#)
- [*OPC](#)

*WAI

The *WAI command:

- **Stops the analyzer** from processing subsequent commands until all overlapped commands are completed.
- **It does NOT stop the controller** from sending commands to this and other devices on the bus. This is the easiest method of synchronization.

Example of the *WAI command

```
GPIB.Write "ABORT;:INITIATE:IMMEDIATE" 'Restart the measurement.
GPIB.Write "CALCULATE:MARKER:SEARCH:MAXIMUM" 'Search for max amplitude.
GPIB.Write "CALCULATE:MARKER:X?" 'Which frequency?
```

The following time line shows how the processing times of the three commands relate to each other:

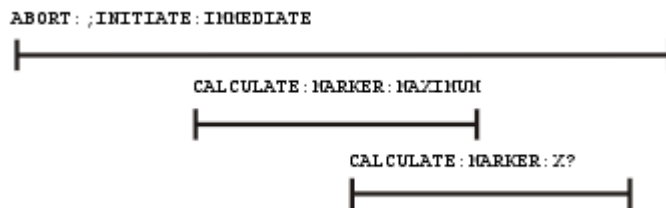

INITIATE:IMMEDIATE is an overlapped command. It allows the immediate processing of the sequential command, CALCULATE:MARKER:SEARCH:MAXIMUM. However, the INITIATE:IMMEDIATE is not considered complete until the measurement is complete. Therefore, the marker searches for maximum amplitude before the measurement completes. **The CALCULATE:MARKER:X? query could return an inaccurate value.**

To solve the problem, insert a *WAI command.

```
GPIB.Write "ABORT;:INITIATE:IMMEDIATE" 'Restart the measurement.
GPIB.Write "*WAI" 'Wait until complete.
GPIB.Write "CALCULATE:MARKER:MAXIMUM" 'Search for max amplitude.
GPIB.Write "CALCULATE:MARKER:X?" 'Which frequency
```

The time line now looks like this:

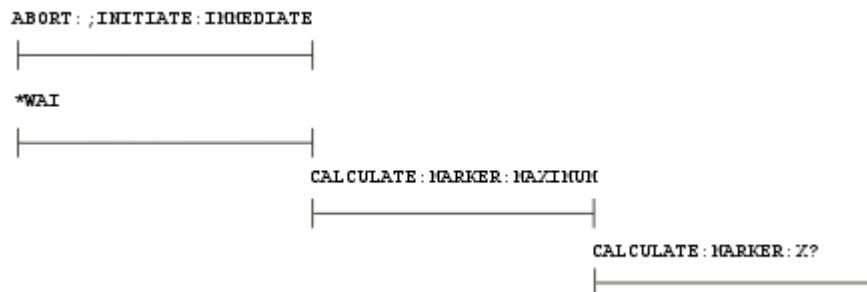

The `*WAI` command keeps the `MARKER:SEARCH:MAXIMUM` from taking place until the measurement is completed. The `CALCULATE:MARKER:X?` query returns the correct value.

Note: Although `*WAI` stops the analyzer from processing subsequent commands, it does not stop the controller. The controller could send commands to other devices on the bus.

*OPC?

The `*OPC?` query stops the controller until all pending commands are completed.

In the following example, the **Read** statement following the `*OPC?` query will not complete until the analyzer responds, which will not happen until all pending commands have finished. Therefore, the analyzer and other devices receive no subsequent commands. A "1" is placed in the analyzer output queue when the analyzer completes processing an overlapped command. The "1" in the output queue satisfies the **Read** command and the program continues.

Example of the *OPC? query

This program determines which frequency contains the maximum amplitude.

```
GPIB.Write "ABORT; :INITIATE:IMMEDIATE"! Restart the measurement
GPIB.Write "*OPC?" 'Wait until complete
Meas_done = GPIB.Read 'Read output queue, throw away result
GPIB.Write "CALCULATE:MARKER:MAX" 'Search for max amplitude
GPIB.Write "CALCULATE:MARKER:X?" 'Which frequency?
Marker_x = GPIB.Read
PRINT "MARKER at " & Marker_x & " Hz"
```

*OPC

The `*OPC` command allows the analyzer and the controller to process commands while processing the overlapped command.

When the analyzer completes processing an overlapped command, the `*OPC` command sets bit 0 of the standard event register to 1. This requires polling of status bytes or use of the service request (SRQ) capabilities of your controller. See [Reading the Analyzer's Status Registers](#) for more information about the standard event status register, generating SRQs, and handling interrupts.

Note: Be careful when sending commands to the analyzer between the time you send `*OPC` and the time you receive the interrupt. Some commands could jeopardize the integrity of your measurement. It also could affect how the instrument responds to the previously sent `*OPC`.

Example of polled bit and SRQ processes.

When To Synchronize the Analyzer and Controller

The need to synchronize depends upon the situation in which the overlapped command is executed. The following section describes situations when synchronization is required to ensure a successful operation.

- [Completion of a Measurement](#)
- [Measurements with External Trigger](#)
- [Averaged Measurements](#)

Completion of a Measurement

To synchronize the analyzer and controller to the completion of a measurement, use the `ABORT; INITIATE: IMMEDIATE` command sequence to initiate the measurement.

This command sequence forces data collection to start (or restart) under the current measurement configuration. A restart sequence, such as `ABORT; INITIATE: IMMEDIATE` is an overlapped command. It is complete when all operations initiated by that restart command sequence, including the measurement, are finished. The `*WAI`, `*OPC?` and `*OPC` commands allow you to determine when a measurement is complete. This ensures that valid measurement data is available for further processing.

Measurements with External Trigger

See [Triggering the VNA using SCPI](#).

[External Triggering](#)

Averaged Measurements

Averaged measurements are complete when the average count is reached. The average count is reached when the specified number of individual measurements is combined into one averaged measurement result. Use synchronization to determine when the average count has been reached.

If the analyzer continues to measure and average the results after the average count is reached, use synchronization to determine when each subsequent measurement is complete.

During Calibration Acquire

During a calibration with slow sweep speeds, such as when using a narrow IF bandwidth, you may want to have your program perform other operations, such as checking for the click event of a Cancel button.

To do this, use the optional ASYNchronous argument with the ACQUIRE command as shown in several calibration example programs. The VNA parser returns immediately while the cal step measurement proceeds. It does NOT block commands and wait for the measurement step to finish. You can send `*ESR?` or `*STB?` queries to monitor the status register bytes to see when the OPC (operation complete) bit gets set, which indicates the cal measurement step has finished. Learn more about [status registers](#).

Note: Do NOT issue the `*OPC?` command when using the ASYN argument. If your program is using the `ScpiStringParser`, then you can ONLY use `*OPC?` to detect when the OPC bit is set, so do NOT use the ASYN argument with the calibration commands when using that parser.

When using the ASYN argument, set the timeout value in the IO settings to at least 5 seconds. There are intervals during the cal acquires when the VNA takes a several seconds to respond to additional commands, such as when the processor is calculating error terms.

The following commands have this argument:

Command	Example
SENS:CORR:COLL:GUID:ACQUIRE (Guided Cal)	Guided 2-Port or 4-Port Cal
SENS:CORR:COLL:ACQUIRE (Unguided Cal)	Perform Unguided ECAL
SOUR:POW:CORR:COLL:ACQUIRE (Source Power Cal)	Perform a Source and Receiver Power Cal (shows polling loop)

In addition, the [SENS:CORR:COLL:GUIDed:INITialize](#) command has this optional argument for long calibration initialization, such as a [CalAll](#) calibration.

Last Modified:

10-Oct-2014 First Release



The VNA as a USB Device

VNA can be controlled as a USB Device using SCPI. This is done through the Keysight I/O Libraries which must be installed on your remote computer.

All data types, especially [Binary block data](#), transfer MUCH faster using USB as compared to GPIB.

To communicate with the VNA as a USB device

1. Connect the VNA to the remote computer using the rear-panel device-side USB connector.
2. The 'Found New Hardware' wizard is launched. Follow the prompts to install the VNA driver software.
3. The Keysight I/O Libraries will recognize the VNA as a Test and Measurement device and show the following dialog.

Note: The VNA is not a USB Mass Storage Device. Therefore, Windows Explorer does NOT recognize it as a USB device. You can NOT use Windows Explorer to transfer files to and from the VNA. For file transfer, use the SCPI command [MMEM:TRANsfer](#).

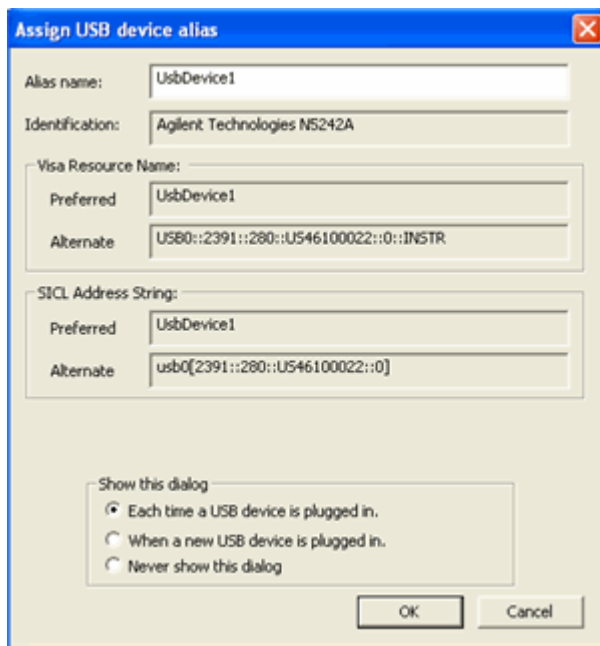

Alias name Change this to a name that is easy to recognize. Once configured, use the Alias name to communicate with the USB device using applications such as VISA and SICL:

- VISA: `viOpen (...,"UsbDevice1",...)`
- SICL: `iopen ("UsbDevice1")`

For more information, see the Connectivity Guide in the Keysight I/O libraries.

Last Modified:

10-Oct-2014 First Release

Reading the Analyzer's Status Register

The VNA has several status registers that your program can read to know when specific events occur. There are two methods of reading the status registers in the analyzer: the Polled Bit method and the Service Request method.

- [The Status Registers](#)
- [Setting and Reading Bits in Status Registers](#)
- [Polled Bit Method](#)
- [Service Request Method](#)

See Also

[IEE 482 Common commands](#)

Example: Status Reporting

[Status Commands](#)

Other Topics about GPIB Concepts

Important Notes:

- A new [Limit Line Fail command](#) that makes it easy to determine if Limit Line testing has failed.
- [*OPC?](#) can be used to easily determine when a channel has completed a sweep. This requires no interaction with the Status Register system. Most VNA programming examples use [*OPC?](#).
- Most of the Status Register system can NOT be used with the SCPIStringParser Object. However, [*OPC?](#) can be used.

The Status Registers

Most of the status registers in the analyzer have sixteen bits. For simplicity, this topic will illustrate their use with 8-bit registers. Bits in registers represent the status of different conditions inside of the analyzer. In the following graphic, a register is represented by a row of boxes; each box represents a bit. Bit 3 is ON.

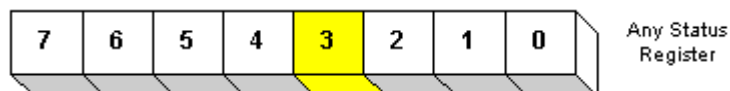

Each VNA Status Register is actually comprised of the following registers. [See an image of the VNA Status registers.](#)

- **Enable Registers** - When using the [SRQ method of polling](#), you first set bits in the enable register which tells the VNA which events to monitor. This is not necessary using the [Polled Bit method](#), as you can only monitor a single event. A [*CLS](#) (clear status) command will not clear the enable register. The [*ESE](#) and [*ESE?](#) commands are used to set and query Enable bits, while [*ESR](#) is used to read and clear an Enable register. [Learn how to set bits.](#)
- **Condition Registers** - A condition register continuously monitors events in the VNA. Bits in the condition register change real time as conditions occur. These bits are not latched, so this

register is used mainly for diagnostic purposes. The registers that only summarize lower level registers do NOT have a condition register.

- **Event Registers** - This is the register that is read to determine if an event has occurred. An event register latches the bits from the corresponding condition register. When an event register bit is set, subsequent changes to the corresponding condition register bit are ignored. The bit remains set until a query command such as *CLS clears the bit. [Learn how to read the Event Register.](#)
- **Positive and Negative Transition Registers** - Transition registers control what type of in a condition register will set the corresponding bit in the event register.
 - **Positive** transitions (**0 to 1**) are only reported to the event register if the corresponding positive transition bit is set to 1.
 - **Negative** transitions (**1 to 0**) are only reported to the event register if the corresponding negative transition bit is set to 1.
 - Setting **both** transition bits to 1 causes both **positive and negative** transitions to be reported.

Transition registers are read-write and are unaffected by *CLS (clear status) or queries. They are reset to their default settings at power-up and after *RST and SYSTem:PRESet commands. The **following are the default settings** for the transition registers:

- All Positive Transition registers = 1
- All Negative Transition registers = 0

This means that, by default, the analyzer will latch all event registers on the negative to positive transition (0 to 1).

The following is an example of why you would set transition registers:

A critical measurement requires that you average 10 measurements and then restart averaging. You decide to poll the averaging bit. When averaging is complete, the bit makes a positive transition. After restart, you poll the bit to ensure that it is set back from 1 to 0, a negative transition. You set the negative transition bit for the averaging register.

Setting and Reading Bits in Status Registers

Both the Polled-Bit method and Service Request method require that you set and read status register bits. Most of the VNA status registers contain 16 bits, numbered 0 to 15. Each bit has a weighted value. The following example shows how to set the bits in a 8-bit status register.

8-bit register

Bit	0	1	2	3	4	5	6	7
Weight	1	2	4	8	16	32	64	128

How to set bits 4 and 5 in the Standard Event Status Enable register:

Step	Example
1. Determine the weighted bit value for these bits	weights 16 and 32 (respectively)
2. Add these values together	$16 + 32 = 48$
3. Send this number as an argument in the	STAT:QUES:LIMIT1:ENAB 48

appropriate command. (see [Status Commands](#))

The Polled Bit Method

With the Polled Bit Method, your program monitors a bit in the status register that represents the condition of interest to you. When the VNA sets the bit to 1, your program sees it and responds accordingly.

- If your program **periodically** monitors a bit in the status register, it is free to do other things as well. However, your program can respond only as fast as the bit is polled.
- If your program **continually** monitors a bit, it can respond immediately, but will be unavailable to do anything other than poll the bit.

Advantage: This method requires very little programming.

Procedure:

1. Decide which condition to monitor. The [Status Commands](#) topic lists all of the possible conditions that can be monitored in the analyzer.
2. Determine the command to be used to monitor the bit.
3. Determine how often to poll the bit until it is set.
4. Construct the routine to respond when the bit is set.

The Service Request (SRQ) Method

Your program enables the bits in the status registers representing the condition of interest. When the condition occurs, the VNA actively interrupts your program from whatever it is doing, and an event handler in your program responds accordingly. Do this method if you have several conditions you want to monitor or the conditions are such that it is not practical to wait for the condition to occur.

Advantage: This method frees your program to do other things until the condition occurs. The program is interrupted to respond to the condition.

Disadvantage: This method can require extensive programming depending on the number and type of conditions that you want to monitor.

Procedure:

1. Decide which conditions to monitor. The [Status Commands](#) topic lists all of the possible analyzer conditions that can be monitored.
2. Set the enable bits in the **summary** registers and the **status byte** register.

Enabling is like making power available to a light. Without power available, the switch can be activated, but the light won't turn ON. In the analyzer, without first enabling a bit, the condition may occur, but the controller won't see it unless it is enabled.

The condition, and the bit in the **summary** registers in the reporting path, must be enabled. This is like streams (conditions) flowing into rivers (summary registers), and rivers flowing into the ocean (controller). See the diagram of status registers in [Status Commands](#).

Bit 6 of the **status byte** register is the only bit that can interrupt the controller. When **any** representative bit in the status byte register goes ON, bit 6 is automatically switched ON.

3. Enable your program to interrupt the controller. This is done several ways depending on the programming language and GPIB interface card you use. An example program is provided showing how this is done with in Visual Basic with a National Instruments GPIB card.

E5080A

4. Construct a subroutine to handle the interrupt event. If you are monitoring more than one condition in your system, your event handler must determine which condition caused the interrupt. Use the *SPE command to determine the instrument that caused the interrupt, then poll the summary registers, then poll condition registers to determine the cause of the interrupt.



Referring to Traces, Measurements, Channels, and Windows Using SCPI

Sometimes in a SCPI program you may need to refer to traces that you have not created. This can be a bit confusing in the VNA. Here are the THREE ways to refer to a specific measurement trace.

Note: The terms "Trace" and "Measurement" effectively mean the same thing in this discussion.

1. The **Trace Number** is also picked by you when 'feeding' a newly-created measurement name to a window number using [DISP:WINDow<wmun>:TRACe<tnum>:FEED](#). The trace number is used ONLY by SCPI and is mainly used to refer to traces in the DISPlay node. This is NOT the number that appears as **Tr#** on the screen. While you can assign any Trace number you want, when a measurement is created from the GUI, the VNA assigns numbers to the traces sequentially, starting with one in each window. Therefore, when there is more than one window, these numbers are not unique.
2. The **Tr#** that appears on the VNA screen is the third and most visible way to refer to a trace. Since we already have a "Trace Number", we call this the **Measurement Number** in the VNA Help file. This number is issued sequentially by the VNA regardless of channel and window. It is therefore unique among all traces. [CALC<cnum>:MEAS<mnum>:xxxxx](#) commands specify the Channel number and **Measurement Number**. This command returns the name of the active measurement: [SYSTem:ACTive:MEAS?](#)

The concept of the **Active measurement** versus **Selected Measurement** is also a bit confusing. As seen on the screen, the Active measurement has the highlighted Tr# . While there can only be ONE active measurement, every channel has a selected measurement. The target measurement must first be selected before most CALC node settings can be made.

1. Use [CALC<cnum>:PAR:MNUM <measNum>](#) which requires the channel and measurement (**Tr**) number.

Here are other relevant commands for referring to traces, measurements, channels, and windows:

- [CALC<cnum>:PAR:CATalog:EXTended?](#) - Catalog the Measurement Names for the specified channel.
- [SYSTem:ACTive:CHANnel?](#) - Returns the number of the active channel. The active channel is the channel number that contains the active measurement.
- [SYSTem:ACTive:MEAS?](#) - Returns the name of the active measurement. As seen on the screen, the Active measurement has the highlighted Tr#.
- [SYSTem:CHANnels:CATalog?](#) - Returns the channel numbers currently in use.
- [SYSTem:WINDows:CATalog?](#) - Returns the window numbers that are currently being used.
- [SYSTem:MEAS:CATalog? \[chan\]](#) - Returns ALL measurement numbers, or optionally measurement numbers from a specified channel.
- [SYSTem:MEAS<n>:NAME?](#) - Returns the name of the specified measurement (Tr#) number.
- [SYSTem:MEAS<n>:TRACe?](#) - Returns the trace number of the specified measurement number.
- [SYSTem:MEAS<n>:WINDow?](#) - Returns the window number of the specified measurement number.

Last modified:

10-Oct-2014 First Release

Configure for SCPI LAN using SICL / VISA

- [VNA Supported Interfaces](#)
- [Keysight I/O Libraries](#)
- [SICL / VISA Programs Running on the VNA](#)
- [Configure the VNA for SICL / VISA](#)
- [Configure the External Controller](#)

Other Topics about GPIB Concepts

VNA Supported Interfaces

The VNA supports the following interfaces for SICL / VISA communication:

- **LAN** - as a remote GPIB interface. The VNA LAN is presented as a virtual GPIB interface. It does NOT support simple TCPIP-based control. Therefore, when configuring the Keysight IO libraries on your PC, add a **REMOTE GPIB** interface, which uses the LAN client interface.
- **GPIB** - requires that your external controller have a GPIB card.

The following interfaces are NOT supported:

- **USB**
- **Serial**

Important Note:

To enable VISA or SICL communication over LAN, you must do the following:

1. On the VNA, click **System**, point to **Configure**, then click **SICL/GPIB**.
2. Check **SICL Enabled**. To automatically enable SICL when the VNA is booted, check **Automatically enable on Startup**.
3. Click **OK**.

The VNA is now ready to be controlled over LAN.

[Learn more about this dialog box.](#)

Keysight I/O Libraries

The Keysight I/O libraries includes the drivers to allow you to communicate with Keysight test instruments. Every VNA is shipped with the Keysight I/O libraries installed. We recommend you do NOT upgrade the Keysight I/O libraries on the VNA as unexpected results may occur. If you choose to upgrade the Keysight I/O libraries on the VNA, do NOT change the default folder path in the InstallShield Wizard.

To communicate with the VNA, the Keysight I/O libraries must also be installed on your external controller. To purchase the Keysight I/O libraries, or download a free upgrade, go to www.Keysight.com and search for IO Libraries. Scroll to find Software, Firmware & Drivers.

SICL / VISA Programs Running on the VNA

You can run your SICL / VISA program on the VNA to control the VNA. Although the Keysight I/O libraries are already installed on the VNA, it is configured as the **Host**. You must also configure a SICL or VISA LAN **Client** interface on the VNA, specifying the LAN hostname of that same VNA.

If your program uses the COM interface to VISA, and is compiled on a PC with the Keysight IO Libraries Suite (version 14 or later), and the resulting executable is copied and run on the VNA, it will produce a "type mismatch error". This is because the VNA has the 'M' version of Keysight I/O libraries. The following

Visual Basic code is an example of how to avoid this error when communicating with the VNA from within the VNA:

```
Dim rm As IResourceManager
Dim fmio As IFormattedIO488
Set rm = CreateObject("AgilentRM.SRMcls")
Set fmio = CreateObject("VISA.BasicFormattedIO")
Set fmio.IO = rm.Open("GPIB0::22")
fmio.WriteString "*IDN?" & Chr(10)
MsgBox fmio.ReadString()
```

Controlling the VNA over LAN while controlling other instruments over GPIB

The VNA can NOT be both a controller and talker/listener on the same GPIB bus. Using SICL / VISA, you can use LAN to control the VNA, leaving the VNA free to use the rear-panel GPIB interface to control other GPIB devices.

Configure the VNA for SICL / VISA

1. On the VNA, click **System** then check **Windows Taskbar**
2. Click **Start** then point to **Program Files, Keysight IO Libraries**, then click **IO Config**
3. Select each GPIB Interface and click **Edit** to verify (or make) the default settings in the following table. These settings are REQUIRED when using a [82357B USB / GPIB](#) Interface with the VNA.
4. When complete, click **OK** to close the edit dialog.
5. Click **OK** to close the IO Config dialog.

VISA Interface Name	SICL Interface Name	Dialog box title	Description
GPIB0	gpib0	GPIB Using NI-488.2	VNA Rear-panel GPIB connector. This GPIB interface can be used to control the VNA OR for the VNA to control external equipment. IT CAN NOT DO BOTH IN THE SAME PROGRAM. Learn more about pass-through options.
GPIB1	hpib7	Internal Instrument Configuration	Internal interface for programs running on the VNA to control itself.
GPIB4	inst0	Internal Instrument Configuration	Used for LXI compliance . Do NOT delete this interface.

Configure the External Controller

Please refer to the Keysight I/O libraries documentation to learn how to configure your controller to communicate with the VNA. These links can show you how to find the following VNA information:

- VNA full computer name
- [GPIB Address](#)
- IP Address

This example program can help test your VISA configuration.

Rear Panel IO Connectors

Interface Control

The Interface Control feature allows you to send remote commands and data to the following VNA rear-panel Interfaces: GPIB, Material Handler I/O, Test Set I/O, and Auxiliary I/O.

- [Overview](#)
- [How to Access Interface Control Settings](#)
- [Interface Control Dialog Box](#)

Other System Configuration Topics

Note: Interface Control can be used ONLY with Standard channels; NOT with Application channels.

Overview

The Interface Control feature allows you to send data to control external equipment such as GPIB instruments, a material handler, test set, or other equipment, without needing to create a remote program. The VNA manages the timing and required interface setup. See Rear Panel Tour

- A unique set of control data can be sent for each channel. In addition, a unique set of control data can be sent before the channel sweep starts, and after the sweep ends.
- Interface Control settings can be saved and recalled from the [Interface Control dialog box](#), or with [Instrument State Save and Recall](#).
- Interface Control settings can be copied to other channels using [Copy Channels](#).
- Control data can only be WRITTEN to the interfaces, NOT READ from the interfaces.
- Control data is sent in the following order. This order cannot be changed.
 1. [GPIB Interface](#)
 2. [Dwell Time](#)

How to access Interface Control settings

Using **Hardkey/SoftTab/Softkey**

1. Press **Setup** > **Internal Hardware** > **Interface Control...**

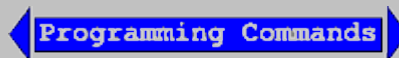

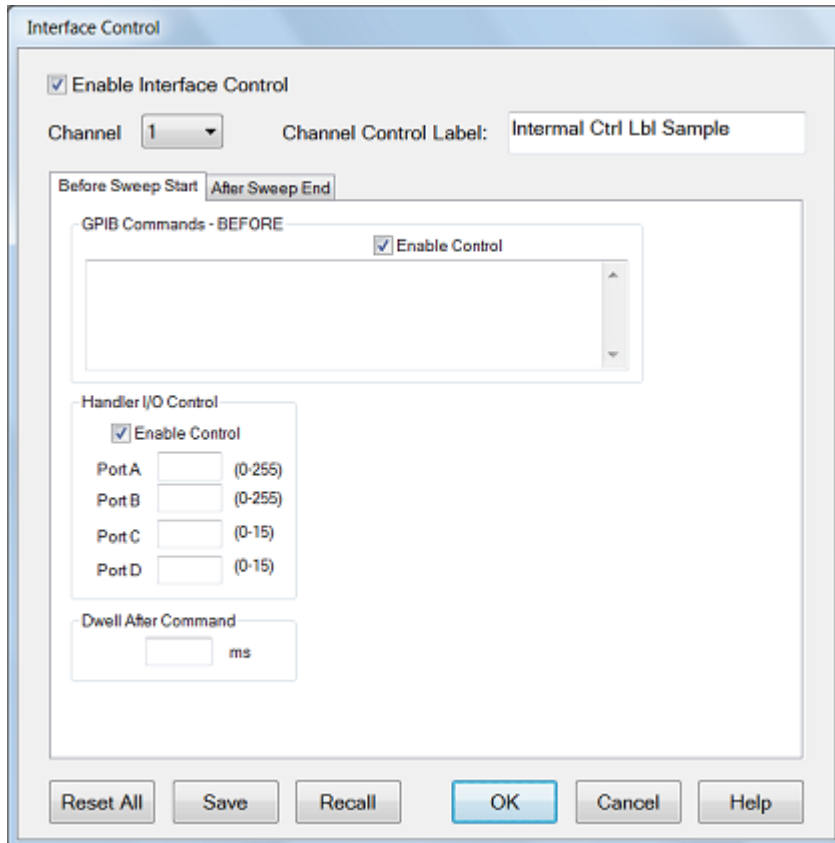

Interface Control dialog box help

See [Interface Control Overview \(scroll up\)](#)

An [Instrument Preset](#) will reset all of the fields to their default settings.

Note: If an error is encountered when sending Interface Control data, an error message is displayed on the VNA screen. The [Channel Trigger State](#) is set to Hold. You must fix the condition that caused the error, then change the Channel Trigger State to its original setting.

Enable Interface Control Enables and disables ALL Interface Control communication. When cleared (default setting) Interface Control is disabled and NO data is sent. To send data, the individual interfaces must also be enabled.

Channel Specifies the channel number for dialog settings. Each channel is configured individually. The list box shows the channels that currently have measurements. There must be at least one measurement present in order to make settings.

Channel Label Specifies the label (D in the following figure) to be displayed on the status bar at the bottom of the VNA screen. The status bar is automatically displayed when Interface Control is enabled.

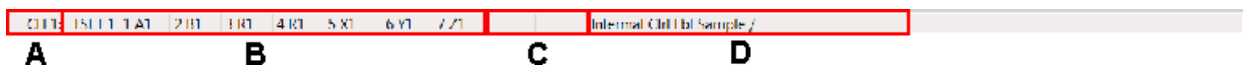

[Learn about the primary status bar.](#)

Before Sweep Start - After Sweep End Tabs

Commands / data for all four interfaces can be sent both Before Sweep Start and After Sweep End. However, they are configured and enabled on separate tabs of the Interface Control dialog box. For example, to send GPIB commands both Before and After a VNA sweep, the Enable Control checkbox must be selected and commands entered on BOTH the Before Sweep Start and After Sweep End tabs.

Before Sweep Start The data is sent BEFORE the first trace on the channel begins sweeping.

After Sweep End The data is sent AFTER the last trace on the channel completes sweeping.

GPIB Commands

Notes:

- GPIB instruments CAN be connected to the VNA using a [USB/GPIB adapter](#).
- GPIB Queries are NOT supported.

Enable Control Enables and disables sending commands out the GPIB interface.

Multi-line edit control Each line contains a GPIB command using the following syntax:

```
address  command
```

Where:

address a number between 0 and 31. The VNA will look through all of the GPIB interfaces for an instrument connected to the specified address. If an instrument with that address is not recognized, an error is returned.

command a GPIB command, with or without enclosing quotes. Enclosing quotes are ignored.

Address and command are separated by at least one space.

Commands should be separated by a new line, or carriage return. For example:

```
19 ":init:cont off"
16 init:imm
```

The front-panel **Enter** key inserts a new line into the field.

The number of GPIB commands that can be entered is limited only by the available memory of the VNA.

Handler I/O

Enable Control Enables and disables sending data out the Handler IO Connector (E5080A)

Ports A, B, C, D Sends values to the respective Handler I/O port. Although ports C and D are normally bidirectional, ONLY Output mode is allowed using the Interface Control feature. It cannot read from these, or any other, ports.

Dwell After Command Specifies a wait time, in milliseconds, after all commands to all interfaces are sent. Any positive integer is allowed. This is used to allow all external devices to settle before beginning a measurement. An erratic trace could indicate that more settling time is necessary.

Reset All Sets ALL fields on ALL channels to their default values.

Save and Recall Saves and recalls the contents of this dialog box. If the Interface Control dialog box is populated with settings during an [Instrument State Save](#), the settings are automatically recalled with the Instrument State settings.

Interface control uses an *.xml file type. An example file is stored on the VNA hard drive. You can recall it into the dialog, or you can open and edit it with a word processor, such as Word Pad.

OK Applies the settings and closes the dialog box.

Cancel Does not apply changes that were made, and closes the dialog box.

Last Modified:

29-Sep-2015 First Release



Programming Guide

Two ways to find programming commands:

1. From a User Interface (Hardkey):

Trace
 Channel
 Display
 Setup
 Meas
 Format
 Scale
 Math
 Avg BW
 Calibration
 Marker
 Search
 Save Recall
 Power
 Frequency
 Sweep
 Trigger
 System

	GPIB / SCPI
2.	<u>Command Tree</u>
See Also	Example Programs Learning about GPIB

See Also

- Shut Down or Restart the VNA Remotely
- [LXI and VXI Compliance](#)
- [Using Macros](#)
- Code Translator App.
- Data Access Map

LXI and VXI Compliance

The VNA products are LXI and VXI compliant.

LXI

Learn more about LXI at <http://www.lxistandard.org/>

VXI

Learn more about VXI at <http://www.vxi.org/>

LAN Status

When a LAN connection is used with the VNA, the LAN Status dialog allows you to see the IP address and other LAN connection properties.

How to view LAN Status

Using **Hardkey/SoftTab/Softkey**

1. Press **System > System Setting > Lan Status....**

Using a mouse

1. Right click on the LCL (or RMT) icons on the status bar.
2. Select on **Lan Status....**

◀ Programming Commands ▶

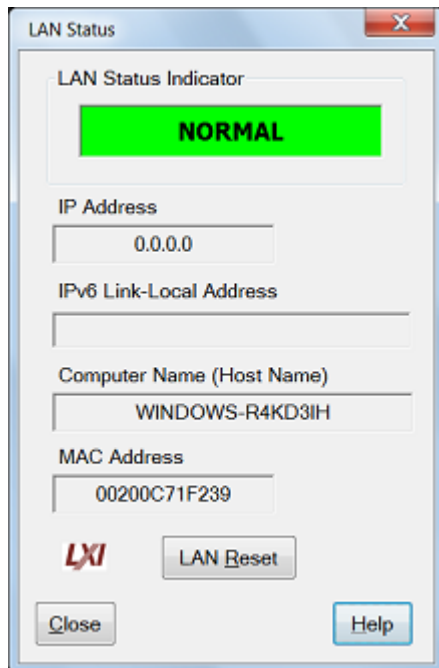

LAN Status dialog box help

Indicator Shows the current status of the LAN connection.

NORMAL - Indicates that the VNA LAN is ready for communication.

IDENTIFY - Indicates that a remote computer has invoked an LXI identification operation on the VNA using the web-based interface or LXIDeviceIDState COM property.

FAULT - Indicates that the VNA LAN interface is not connected to the Internet.

IP Address Shows the current IPv4 address of the VNA

IPv6 Link-Local Address Shows the current IPv6 address of the VNA

Computer Name Shows the full computer name of the VNA. Learn how to change this. If you see the IP address listed here, that means there is no DNS server specified in the network setup.

MAC Address Shows the unique address of the VNA computer. Also known as HostID.

LAN Reset Provides a LAN Configuration Initialize (LCI) mechanism. Press to return the following settings to factory default conditions:

- **IP Address Configuration (DHCP):** Enabled
- **ICMP Ping Responder:** Enabled
- **Web Password for configuration:** Resets the password to 'Keysight'.

Web Server Software

If your VNA is LXI Class C compliant ([see above](#)), you can connect to the VNA using a web browser over an internet connection.

To do this, when the above dialog indicates a **NORMAL** condition:

1. From a web browser, type **http://<your_VNA_computer_name>**. For example, to connect to the fictitious VNA in the dialog above, type: **http://WINDOWS-R4KD3IH**
2. You will see the welcome screen with connection links.

Last modified:

29-Sep-2015 First Release

Using Macros

Macros are executable programs that you write, load into the analyzer, and then run from the analyzer. You can have up to 25 macros set up to run on the analyzer.

- [How to Setup Macros](#)
- [How to Run Macros](#)
- [Macro Example](#)

How to Setup Macros

Using **Hardkey/SoftTab/Softkey**

1. Press **Macro** > **Key Setup** > **Macro Setup...**

In the Macro Setup dialog box:

1. Create an executable program and save it on the VNA hard drive. See SCPI example programs in VBscript.
2. Use a mouse or the front-panel 'down-arrow' to select a blank line below the last entry. (There may be NO entry.)
3. Click **Edit** to start the [Edit Macro Setup](#) dialog.
4. In the **Macro Title** box, type a descriptive title for your macro.
5. Click **Browse...**
6. Change **Files of Type**.
7. Find and select your executable file. Change **Files of Type** if necessary.
8. Click **OK** on the Edit Macro Setup dialog.
9. Click **OK** on the Macro Setup dialog.
10. Press **MACRO** to run. It may be necessary to first Preset the VNA to see your macro in the menu.

Macro Setup dialog box help

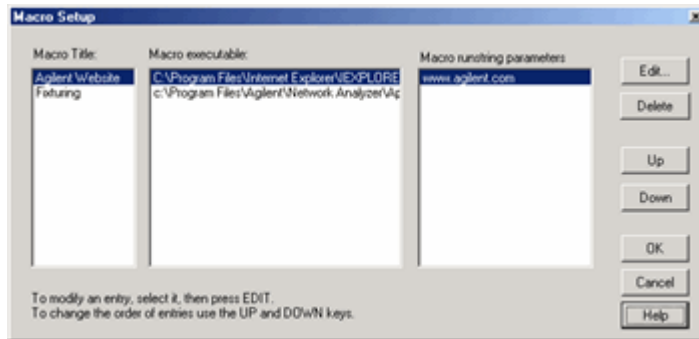

Macro setup allows you to create up to 25 macros that can be launched from the VNA application.

An external keyboard is required to enter the Macro Title and the Run string parameters.

To add a Macro, use a mouse or the front-panel 'down arrow' (NOT the 'Down' key) to select a blank line. Then click **Edit**.

Macro Title Shows the titles that appear in the softkeys and menu when you press the Macro key. These titles are associated with the executable files and should be descriptive so you can easily identify them.

Macro Executable Lists the complete path to the executable file. To follow the example of launching the Keysight VNA Series Home Page, the path to the executable could be "C:/Program Files/Internet Explorer/iexplore.exe".

Macro Runstring Parameters Lists the parameters that get passed to the program that is referenced in the executable file. Again following the example of launching the VNA Series Home Page, you could assign the runstring parameters "http://www.Keysight.com/find/pna".

Edit Invokes the [Macro Edit dialog box](#).

Delete Deletes the selected macro.

Up Allows you to reorder the macros, moving the selected macro up one line. This order determines how they appear in the VNA Menu and in the softkeys and when you press the Macro front-panel key.

Down Moves the selection down one line in the list of macros.

Macro Edit dialog box help

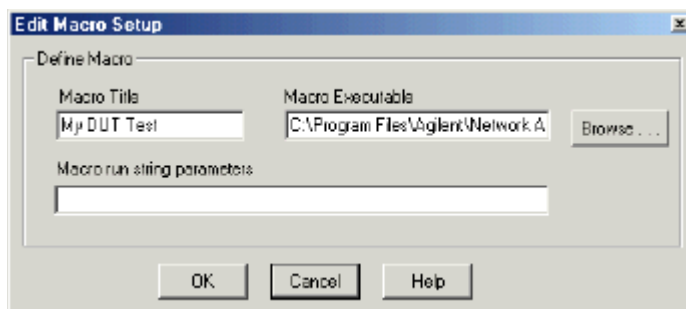

Macro Title Add a title that appears in the softkeys and menu.

Macro Executable Set the complete path to the macro executable file. Click **Browse** to navigate to the macro executable file and establish the complete path to the file.

Macro run string parameters Optionally add parameters that are passed to the program referenced

in the executable file.

[See Macro Setup dialog box](#)

How to Run Macros

Using **Hardkey/SoftTab/Softkey**

1. Press **Macro** > **Macro<#>**
2. then select the macro to run

Macro Example

The following is an example Visual Basic Scripting (vbs) program that you can copy, install, and run on your VNA.

Note: Print these instructions if viewing in the analyzer. This topic will be covered by the Macro Setup dialog box.

1. Copy the following code into a Notepad file.
2. Save the file on the analyzer hard drive in the **C:/Documents** folder. Name the file **FilterTest.vbs**
3. Close Notepad
4. [Setup the macro in the VNA](#)
5. [Run the macro](#)

Notepad is a text editor that is installed on all PCs that use a Microsoft Operating system. To launch Notepad on the analyzer:

1. Click **View**, then click **Title Bars**
2. Click the **Start** button on the windows taskbar
3. Point to **Programs, Accessories**.
4. Click **Notepad**

```
'Start copying here
'This program creates a S21 measurement
'It is written in VBscript using SCPI commands

Dim app
Dim scpi
'Create / Get the VNA application
Set app = CreateObject ("AgilentPNA835x.Application")
Set scpi = app.ScpiStringParser

'Preset the Analyzer.FPReset presets the setting and deletes all traces and
windows
scpi.Execute ("SYST:FPReset")
'Create and turn on window 1
scpi.Execute ("DISPlay:WINDow1:STATE ON")
'Define a measurement name, parameter
scpi.Execute ("CALCulate:PARAMeter:DEFine:EXT 'MyMeas', 's21'")
'Associate ("FEED") the measurement name ('MyMeas') to WINDow (1), and give
the new TRACE a number (1).
scpi.Execute ("DISPlay:WINDow1:TRACe1:FEED 'MyMeas'")
```

E5080A

'End copying here

Last Modified:

2-Sep-2014 First Release



Product Support

Troubleshooting the VNA

By running a few checks, you can identify if the analyzer is at fault. Before calling Keysight Technologies or returning the instrument for service, please make the following checks.

- [Check the Basics](#)
- [Check Error Terms](#)
- [Check the Service Guide](#)
- [Error Log Data](#)

Other Support Topics

Check the Basics

A problem can often be solved by repeating the procedure you were following when the problem occurred. Before calling Keysight Technologies or returning the instrument for service, please make the following checks:

Note: Problems with the VNA application (slow or terminates unexpectedly) can be caused by a faulty Solid State Drive (SSD). For more information, see Preventing VNA Hard Drive Problems and [The VNA SSD Recovery Process](#).

1. Is there power at the power socket? Is the instrument plugged in?
2. Is the instrument turned on? Check to see if the front panel line switch and at least one of the LED rings around the test ports glows green. This indicates the power supply is on.
3. If you are experiencing difficulty with the front-panel keypad or peripherals, the USB bus may be overloaded. Remove the USB devices, restart the VNA, and reconnect the USB devices. See [Power-up](#).
4. If other equipment, cables, and connectors are being used with the instrument, make sure they are connected properly and operating correctly.
5. Review the procedure for the measurement being performed when the problem appeared. Are all the settings correct?
6. If the instrument is not functioning as expected, return the unit to a known state by pressing the **Preset** key.
7. Is the measurement being performed, and the results that are expected, within the [specifications](#) and capabilities of the instrument?
8. If the problem is thought to be due to firmware, check to see if the instrument has the [latest firmware](#) before starting the troubleshooting procedure.
9. Check that the measurement calibration is valid. See [Accurate Measurement Calibrations](#) for more information.

Check Error Terms

If you print the error terms at set intervals (weekly, monthly, and so forth), you can compare current error terms to these records. A stable, repeatable system should generate repeatable error terms over long time intervals, for example, six months. If a subtle failure or mild performance problem is suspected, the magnitude of the error terms should be compared against values generated previously with the same instrument and calibration kit. See the [procedure for monitoring error terms](#).

- A long-term trend often reflects drift, connector and cable wear, or gradual degradation, indicating the need for further investigation and preventative maintenance. Yet, the system may still conform to specifications. The cure is often as simple as cleaning and gaging connectors or inspecting cables.
- A sudden shift in error terms reflects a sudden shift in systematic errors, and may indicate the need for further troubleshooting.

Consider the following while troubleshooting:

- All parts of the system, including cables and calibration devices, can contribute to systematic errors and impact the error terms.
- Connectors must be clean and gauged, and within specification for error term analysis to be meaningful. See Chapter 2 in the VNA Service Guide for information on cleaning and gaging connectors.
 - Avoid unnecessary bending and flexing of the cables following measurement calibration, thus minimizing cable instability errors.
 - Use good connection techniques during the measurement calibration. The connector interface must be repeatable. See the VNA Service Guide for information on connection techniques.
- It is often worthwhile to perform the procedure twice (using two distinct measurement calibrations) to establish the degree of repeatability. If the results do not seem repeatable, check all connectors and cables.
- Use error-term analysis to troubleshoot minor, subtle performance problems. See Chapter 3, "Troubleshooting," in the VNA Service Guide if a blatant failure or gross measurement error is evident.

Check the Service Guide

Check the VNA Service Guide for specific troubleshooting procedures to help identify problems. You can download a copy of the Service Guide from our Web site: <http://www.keysight.com/find/na>.

Error Log Data

The VNA creates automatic log of data for troubleshooting purpose. For security reasons, if this data needs to be deleted, then :SERV:LOGG:CLE command can be used to clear the log recorded by the VNA.

The log file stores data related to:

- Power ON time
- Number of times of power ON
- Result of power ON test
- Number of times of overload
- Event Log
- Hardware driver installation/error Log
- Connected USB device Log
- User calibration Log

- Firmware error Log
 - Temperature of analog boards
 - Internal test result
-

Last modified:

10/16/06 Added phase lock lost



VNA Error Messages

- [500 - 750 Calibrate](#)
- [770 - 1000 Hardware](#)
- [1000 - 1200 Measure](#)
- [1281 - 1535 Parser](#)
- [1536 - 1650 Display](#)
- [1700 - 2000 Channel](#)
- [2048 - 2200 General](#)
- [Standard SCPI Errors](#)

Note: The **EventID**'s listed below are provided for COM programming. For more information, see Working with VNA Events

For more information on VNA error messages ([see Error Messages](#)).

Memory Overflow Error

Memory overflow. Trigger state set to Hold. Lower the IF bandwidth, or increase dwell or sweep time.

Severity: Informational

Further explanation: The measurement that you are currently making requires that data be stored faster than it can be processed. Very few customers will experience this situation.

Suggestions: To limit the amount of data to be stored, try lowering the IF Bandwidth, slow the sweep time, increase the dwell time, or limit the number of data points. There are many other settings that can be adjusted to solve this problem.

EventID:

Cal Errors

Message: 512

"A secondary parameter (power, IFBW, sweep time, step mode) of the calibrated state has changed."

Severity: Informational

Further explanation: The calibration is questionable when any of these secondary parameters change after the calibration is performed.

Suggestions: If you require an accurate measurement with the new settings, repeat the calibration.

EventID: 68020200 (hex)

Message: 513

"Calibration cannot be completed until you have measured all the necessary standards for your selected Cal Type."

Severity: Informational

Further explanation: You probably received this message because you attempted to turn correction on without first measuring all of the calibration standards

Suggestions: Finish measuring the cal standards

EventID: 68020201 (hex)

Message: 514

"Calibration set has been recalled using a file previously saved on an analyzer that had a different hardware configuration."

Severity: Informational

Further explanation:

Suggestions:

EventID: 68020202 (hex)

Message: 515

"Calibration is required before correction can be turned on. Channel number is <x>, Measurement is <x>."

Severity: Informational

Further explanation: There are no error correction terms to apply for the specified channel and measurement.

Suggestions: Perform or recall a calibration

EventID: 68020203 (hex)

Message: 516

"Critical parameters in your current instrument state do not match the parameters for the calibration set, therefore correction has been turned off. The critical instrument state parameters are sweep type, start frequency, frequency span, and number of points."

Severity: Informational

Further explanation: None

Suggestions: You can either recalibrate using the new settings or change back to the original setting that was used when the calibration was performed.

EventID: 68020204 (hex)

Message: 517

"Interpolation is turned off and you have changed the stimulus settings of the original calibration, so correction has been turned off."

Severity: Informational

Further explanation: The most accurate calibration is maintained only when the original stimulus settings are used.

Suggestions: If reduced accuracy is OK, set interpolation ON to allow stimulus setting changes.

EventID: 68020205 (hex)

Message: 518

"Interpolation is turned off and you have selected correction ON. Correction has been restored with the previous stimulus settings."

Severity: Informational

Further explanation: None

Suggestions: None

EventID: 68020206 (hex)

Message: 519

"Stimulus settings for your current instrument state exceeded the parameters of the original calibration, so correction has been turned off."

Severity: Informational

Further explanation: Correction data outside the stimulus settings does not exist.

Suggestions: Perform a broadband calibration, with increased numbers of points with interpolation ON, to maintain calibration over the widest possible stimulus frequency settings.

EventID: 68020207(hex)

Message: 520

"Cal Type is set to NONE for Channel <x>, Measurement <x>; please select Calibration menu or press Cal hard key."

Severity: Informational

Further explanation: A cal operation can not proceed until a calibration exists or the cal type is selected. This error can occur if the calibration can not be found. Also this error can happen if a calibration type is not specified before attempting to programmatically execute cal acquisitions.

Suggestions To find a calibration, select a Cal Set that contains the calibration needed for the current measurements. OR specify the cal type before beginning a calibration procedure.

EventID: 68020208 (hex)

Message: 521

"The measurement you set up does not have a corresponding calibration type, so correction has been turned off or is not permitted."

Severity: Informational

Further explanation: The calibration for the channel may apply only to certain S-Parameters. For example, a 1-Port calibration for S11 can not be applied to a 1-Port calibration applied to S22.

Suggestions: Select a calibration type, such as full 2-Port cal, that can be applied to all the measurements to be selected.

EventID: 68020209 (hex)

Message: 522

"The calibration type you selected cannot be set up."

Severity: Informational

Further explanation: "Please use the SCPI command ROUTe:PATH:DEFine:PORT <num>,<num> for full 2 port type port assignment."

Suggestions:

EventID: 6802020A (hex)

Message: 523

"The calibration path you selected cannot be set up because it is not valid for the current measurement."

Severity: Informational

Further explanation: "Please use the SCPI command ROUTe:PATH:DEFine:PORT <num>,<num> for full 2 port type port assignment related to your current measurement."

Suggestions:

EventID: 6802020B (hex)

Message: 524

"The source power calibration is complete."

Severity: Informational

Further explanation:

Suggestions:

EventID: 6802020C (hex)

Message: 525

"You have specified more than 7 standards for one or more calibration classes."

Severity: Informational

Further explanation: These have been truncated to 7 selections.

EventID: 6802020D (hex)

Message: 526

"No user calibration found for this channel."

Severity: Informational

Further explanation: A cal operation can not proceed until a calibration exists.

Suggestions: To find a calibration, you can select a Cal Set that contains the calibration needed for the current measurement.

EventID: 6802020E (hex)

Message: 527

"You do not need to acquire this standard for this calibration type."

Severity: Informational

Further explanation: This error can happen as a result of PROGRAMMATICALLY requesting the measurement of an un-needed calibration standard during a calibration procedure.

Suggestions: Check the specified cal type or eliminate the request for the measurement of the standard.

EventID: 6802020F (hex)

Message: 528

"Could not configure the Electronic Calibration system. Check to see if the module is plugged into the proper connector."

Severity: Informational

Further explanation: During an ECal operation, communication could not be established with the ECal module. The calibration will not be initiated until the presence of the ECal module is verified.

Suggestions: Verify the USB cable is connected properly. Disconnect and re-connect the cable to ensure the analyzer recognizes the module.

EventID: 68020210 (hex)

Message: 529

"DATA OUT OF RANGE: Design Limits Exceeded"

Severity: Error

Further explanation:

Suggestions:

EventID: E8020211(hex)

Message: 530

"EXECUTION ERROR: Could not open ECal module memory backup file"

Severity: Error

Further explanation:

Suggestions:

EventID: E8020212 (hex)

Message: 531

E5080A

"EXECUTION ERROR: Access to ECal module memory backup file was denied"

Severity: Error

Further explanation:

Suggestions:

EventID: E8020213 (hex)

Message: [532](#)

"EXECUTION ERROR: Failure in writing to ECal module memory backup file"

Severity: Error

Further explanation:

Suggestions:

EventID: E8020214 (hex)

Message: [533](#)

"EXECUTION ERROR: Failure in reading from ECal module memory backup file"

Severity: Error

Further explanation:

Suggestions:

EventID: E8020215 (hex)

Message: [534](#)

"EXECUTION ERROR: Array index out of range"

Severity: Error

Further explanation:

Suggestions:

EventID: E8020216 (hex)

Message: [535](#)

"EXECUTION ERROR: Arrays wrong rank"

Severity: Error

Further explanation:

Suggestions:

EventID: E8020217 (hex)

Message: [536](#)

"EXECUTION ERROR: CPU"

Severity: Error

Further explanation:

Suggestions:

EventID: E8020218 (hex)

Message: [537](#)

"EXECUTION ERROR: Cannot ERASE module"

Severity: Error

Further explanation:

Suggestions:**EventID:** E8020219 (hex)**Message:** 538

"EXECUTION ERROR: Cannot WRITE module"

Severity: Error**Further explanation:****Suggestions:****EventID:** E802021A (hex)**Message:** 539

"EXECUTION ERROR: Entry Not Found"

Severity: Error**Further explanation:****Suggestions:****EventID:** E802021B (hex)**Message:** 540

"EXECUTION ERROR: Invalid command while system is busy"

Severity: Error**Further explanation:****Suggestions:****EventID:** E802021C (hex)**Message:** 541

"Electronic Cal: Unable to orient ECal module. Please ensure the module is connected to the necessary measurement ports."

Severity: Error**Further explanation:** There is no RF connection to the ECal module during a calibration step. An ECal orientation measurement has been attempted but the signal was not found.**Suggestions:** Connect the ECal module RF connections to ports specified for the calibration step. The ECal module typically requires at least -18dBm for measurements. If your measurement requires the power level to be less than that, clear the **Do orientation** checkbox to bypass the automatic detection step.**EventID:** E802021D (hex)**Message:** 542

"EXECUTION ERROR: NO SPACE for NEW CAL, DELETE A CAL"

Severity: Error**Further explanation:****Suggestions:****EventID:** E802021E (hex)**Message:** 543

"EXECUTION ERROR: No More Room"

Severity: Error**Further explanation:**

E5080A

Suggestions:

EventID: E802021F (hex)

Message: 544

"EXECUTION ERROR: Other array error"

Severity: Error

Further explanation:

Suggestions:

EventID: E8020220 (hex)

Message: 545

"EXECUTION ERROR: Ranks not equal"

Severity: Error

Further explanation:

Suggestions:

EventID: E8020221 (hex)

Message: 546

"EXECUTION ERROR: Too few CONSTANT ranks"

Severity: Error

EventID: E8020222 (hex)

Message: 547

"EXECUTION ERROR: Too few VARYing ranks"

Severity: Error

EventID: E8020223 (hex)

Message: 548

"EXECUTION ERROR: Unknown error"

Severity: Error

EventID: E8020224 (hex)

Message: 549

"EXECUTION ERROR: ecaldrvr.dll bug or invalid module #"

Severity: Error

EventID: E8020225 (hex)

Message: 550

"EXECUTION ERROR: unexpected error code from ecal driver"

Severity: Error

EventID: E8020226 (hex)

Message: 551

"EXECUTION ERROR: unexpected internal driver error"

Severity: Error

EventID: E8020227 (hex)

Message: 552

"HARDWARE ERROR: Can't access ECal Interface Module"

Severity: Error

EventID: E8020228 (hex)

Message: 553

"HARDWARE ERROR: Can't release LPT port, reboot"

Severity: Error

EventID: E8020229 (hex)

Message: 554

"HARDWARE ERROR: VNA Error"

Severity: Error

EventID: E802022A (hex)

Message: 555

"HARDWARE ERROR: not enough data read from ECal module"

Severity: Error

EventID: E802022B (hex)

Message: 556

"OPERATION ABORTED BY HOST COMPUTER"

Severity: Error

EventID: E802022C (hex)

Message: 557

"OPERATION ABORTED BY USER"

Severity: Error

EventID: E802022D (hex)

Message: 558

"OUT OF MEMORY"

Severity: Error

EventID: E802022E (hex)

Message: 559

"QUERY INTERRUPTED:Message(s Abandoned"

Severity: Error

EventID: E802022F (hex)

Message: 560

"QUERY UNTERMINATED: INCOMPLETE PROGRAM Message"

Severity: Error

Further explanation:

Suggestions:

EventID: E8020230 (hex)

Message: 561

"QUERY UNTERMINATED: NOTHING TO SAY"

Severity: Error

Further explanation:

E5080A

Suggestions:

EventID: E8020231 (hex)

Message: 562

"QUEUE OVERFLOW"

Severity: Error

EventID: E8020232 (hex)

Message: 563

"SETTINGS CONFLICT: ADDITIONAL STANDARDS ARE NEEDED"

Severity: Error

EventID: E8020233 (hex)

Message: 564

"SETTINGS CONFLICT: Adapter Cal is NOT possible"

Severity: Error

EventID: E8020234 (hex)

Message: 565

"SETTINGS CONFLICT: COMMAND OUT OF SEQUENCE"

Severity: Error

EventID: E8020235 (hex)

Message: 566

"SETTINGS CONFLICT: Cal STOPPED - VNA SETUP CHANGED"

Severity: Error

EventID: E8020236 (hex)

Message: 567

"SETTINGS CONFLICT: Calibration is NOT in progress"

Severity: Error

EventID: E8020237 (hex)

Message: 568

"SETTINGS CONFLICT: Can't find specified GPIB board"

Severity: Error

EventID: E8020238 (hex)

Message: 569

"SETTINGS CONFLICT: Can't find/load gpib32.dll"

Severity: Error

EventID: E8020239 (hex)

Message: 570

"SETTINGS CONFLICT: Can't find/load sicl32.dll"

Severity: Error

EventID: E802023A (hex)

Message: 571

"SETTINGS CONFLICT: Can't initialize VNA (bad address?)"

Severity: Error

EventID: E802023B (hex)

Message: 572

"SETTINGS CONFLICT: Can't load LPT port driver or USB driver DLL "

Severity: Error

EventID: E802023C (hex)

Message: 573

"SETTINGS CONFLICT: Invalid Calibration Sweep Mode."

Severity: Error

EventID: E802023D (hex)

Message: 574

"SETTINGS CONFLICT: Invalid Calibration Type"

Severity: Error

EventID: E802023E (hex)

Message: 575

"SETTINGS CONFLICT: Invalid Calibration"

Severity: Error

EventID: E802023F (hex)

Message: 576

"SETTINGS CONFLICT: Invalid GPIB board number specified"

Severity: Error

EventID: E8020240 (hex)

Message: 577

"SETTINGS CONFLICT: Invalid GPIB board type specified"

Severity: Error

EventID: E8020241 (hex)

Message: 578

"SETTINGS CONFLICT: Invalid Module Status"

Severity: Error

EventID: E8020242 (hex)

Message: 579

"SETTINGS CONFLICT: Invalid States"

Severity: Error

EventID: E8020243 (hex)

Message: 580

"SETTINGS CONFLICT: LPT port must be between 1 and 4"

Severity: Error

EventID: E8020244 (hex)

Message: 581

"Could not configure the Electronic Calibration system. Check to see if the module is properly connected."

E5080A

Severity: Error

EventID: E8020245 (hex)

Message: 582

"SETTINGS CONFLICT: Specified LPT port does not exist"

Severity: Error

EventID: E8020246 (hex)

Message: 583

"SETTINGS CONFLICT: Use frequency domain for cal"

Severity: Error

EventID: E8020247 (hex)

Message: 584

"SETTINGS CONFLICT: Use step sweep type for cal."

Severity: Error

EventID: E8020248 (hex)

Message: 585

"SETTINGS CONFLICT: VNA address must be between 0 and 30"

Severity: Error

EventID: E8020249 (hex)

Message: 586

"SETTINGS CONFLICT: Wrong LPT port driver or USB driver DLL"

Severity: Error

EventID: E802024A (hex)

Message: 587

"SYNTAX ERROR: ECAL:DELAY command must have 2 numbers"

Severity: Error

EventID: E802024B (hex)

Message: 588

"SYNTAX ERROR: INCORRECT SYNTAX"

Severity: Error

EventID: E802024C (hex)

Message: 589

"SYNTAX ERROR: UNKNOWN COMMAND"

Severity: Error

EventID: E802024D (hex)

Message: 590

"Wrong port of module in RF path"

Severity: Error

EventID: E802024E (hex)

Message: 591

"User characterization not found in module"

Severity: Error

EventID: E802024F (hex)

Message: 592

Severity: Informational

"No source power calibration found for the channel and source port of the current measurement."

Further explanation: You tried to turn on source power cal but there is no source power cal data.

Suggestions: Perform a source power calibration

EventID: 68020250 (hex)

Message: 593

Severity: Informational

"A source power calibration sweep was not performed, so there is no correction for the channel and source port of the current measurement."

Further explanation: You tried to turn on source power cal but there is incomplete source cal data.

Suggestions: Perform a complete source power calibration

EventID: 68020251 (hex)

Message: 594

Severity: Informational

"A new trace could not be added to the active window for viewing the source power cal sweep, because it would have exceeded the limit on number of traces/window. Please remove a trace from the window before proceeding with source power cal."

Further explanation: The source power cal attempts to add a data trace to the active window. The active window already contains four traces.

Suggestions: Make the active window contain less than four traces.

EventID: 68020252 (hex)

Message: 595

Severity: Informational

"A new measurement could not be added for performing the source power cal sweep, because the limit on number of measurements has been reached. Please remove a measurement before proceeding with source power cal."

Further explanation: The source power cal attempts to add a measurement. The VNA already has the maximum number of measurements.

Suggestions: Delete a measurement.

EventID: 68020253 (hex)

Message: 596

Severity: Informational

"The calibration power value associated with the source power calibration of Port %1 on Channel %2 was changed with the calibration on. The calibration was not turned off, but the power value might no longer represent the calibration."

Further explanation: The source power cal accuracy is questionable.

Suggestions: If high accuracy is required, perform another source power calibration.

EventID: 68020254 (hex)

Message: 597

Severity: Informational

- Message that is passed from the power meter driver for a source power calibration. -

Further explanation: This error is generated by the power meter driver and passed through the VNA.

EventID: 68020255 (hex)

Message: 598

"During the acquisition of the sliding load standard, the slide was not properly moved to perform a circle fit. The standard's raw impedance was used to determine the directivity for one or more points."

Severity: Informational

Further Explanation: To accurately characterize the standard, the sliding load must be move sufficiently to ensure enough samples around the complex circle or Smith Chart. Under-sampling will cause an inaccurate result.

Suggestions: For best results when using a sliding load, be sure to use multiple slide positions that cover the full range of movement from front to back of the slot.

EventID: 68020256 (hex)

Message: 599

"This feature requires an unused channel, but could not find one. Please free up a channel and try again."

Severity: Informational

Further Explanation: You attempted to view an item within a calset. However, the calset viewer requires that the result be displayed in a channel that is not currently in use. All the channels are currently used. The view can not display the requested item.

Suggestions: You must delete at least one channel that is currently in use.

EventID: 68020257 (hex)

Message: 600

"Interpolation of the original calibration is not allowed since it was performed using Segment Sweep. Correction has been turned off."

Severity: Informational

EventID: 68020258 (hex)

Message: 601

"Cal preferences saved. Cal preference settings can be changed from the 'Cal Preferences' drop down Cal menu."

Severity: Informational

Further explanation: [See Save Preference](#)

EventID: 68020259 (hex)

Message: 608

"CalType not set."

Severity: Error

Further explanation: A cal operation can not proceed until a calibration exists or the proper cal type is selected.

Suggestions: This error can happen if the calibration can't be found. To find a calibration, you can select a Cal Set that contains the calibration needed for the current measurements. This error can also happen if a calibration type is not specified before attempting to programmatically execute cal acquisitions. Specify the cal type before beginning a calibration procedure.

EventID: E8020260 (hex)

Message: 609

"The Calibration feature requested is not implemented."

Further explanation: The specified cal type can be one of many choices. For example, response calibrations require single standards, 1-Port calibrations require 3 standards, and 2-Port calibrations require up to 12 standards.

Suggestions: Be sure to measure only the standards needed for the specified cal type.

EventID: E8020261 (hex)

Message: 610

"The Calibration Class Acquisition requested is not valid for the selected Calibration Type. Please select a different acquisition or a different Calibration Type."

EventID: E8020262 (hex)

Message: 611

"The Calibration Standard data required for the selected caltype was not found."

Severity: Error

Further explanation: An unsuccessful attempt was made to retrieve a specified standard from the raw measurement buffer. The buffer should contain the raw measurements of cal standards stored during a calibration procedure.

Suggestions: Be sure the requested standard is required for the current cal type. Not all standards are needed for all cal types.

EventID: E8020263 (hex)

Message: 612

" The Error Term data required for the selected caltype was not found."

Severity: Error

Further explanation: An unsuccessful attempt was made to retrieve a specified error term from the error correction buffer. The buffer should contain the error correction arrays for the current calibration.

Suggestions: Be sure the requested error term is required for the current cal type. Not all error terms are needed for all cal types.

EventID: E8020264 (hex)

Message: 613

The Calibration data set was not found.

Severity: Error

Further explanation: An unsuccessful attempt to access a cal set has been made. This may indicate a calset has been deleted or has been corrupted.

Suggestions: Try again or select another cal set. If the cal set appears in the cal set list, it may need to be deleted.

EventID: E8020265 (hex)

Message: 614

"The specified measurement does not have a calibration valid for Confidence Check. Please select a different measurement, or recall or perform a different Calibration Type."

Severity: Error

Further explanation: The measurement choice is prevented so that calibration will not be turned off. Not all cal types support all measurements. For example, an 1-Port cal on S11 can not be used to calibrate an S12 measurement. When a measurement is selected that does not have a calibration which can be applied, an informational message is displayed and calibration is turned off.

E5080A

Suggestions: Use a full 2-Port calibration to be compatible with any S-Parameter.

EventID: E8020266 (hex)

Message: 615

" New calset created."

Severity: Informational message.

Further explanation: The newly created cal set will be automatically named and time stamped. If this is the beginning of a calibration procedure, the cal set will not be stored to memory until the calibration has completed successfully. The new cal set will be deleted if the calibration is canceled or does not otherwise complete successfully.

Suggestions: Informational

EventID: 68020267

Message: 617

The calset file: <x> appears to be corrupted and cannot be removed. Exit the application, remove the file, and restart.

Severity: Error

Suggestions: The cal set file is stored in the application home directory C:/Program Files/Keysight/Network Analyzer/PNACalSets.dat. Remove this file, then restart the application.

EventID: E8020269 (hex)

Message: 634

"The calset file: <x> load failed."

Severity: Error

Further explanation: The calset file contains a collection of calsets. The file resides on the hard drive.

Suggestions: Try restarting the application. If the failure persists, you may have to delete the cal set data file and restart the application. The cal set file is stored in the application home directory. C:/Program Files/Keysight/Network Analyzer/PNACalSets.dat. Remove this file, then restart the application.

EventID: E802027A (hex)

Message: 635

"The calset file: <x> save failed."

Severity: Error

Further explanation: The file operation detected an error. The save operation was aborted.

Suggestions: Retry.

EventID: E802027B (hex)

Message: 636

"A calset was deleted."

Severity: Informational

Further explanation: One of the calsets has been successfully deleted from the collection of calsets available. This can happen as the result of a user request or intentional operation.

Suggestions: None

EventID: 6802027C (hex)

Message: 637

"The version of the calset file: <x> is not compatible with the current instrument."

Severity: Error

Further explanation: A versioning error can prevent a calset from being used. This can happen as a result of instrument firmware upgrades.

Suggestions: If the versioning error is the result of firmware upgrade, you will have to re-install the old version of firmware to re-use the calset file. Or you can re-create the calsets with the current version of firmware.

The cal set file is stored in the application home directory C:/Program Files/Keysight/Network Analyzer/PNACalSets.dat. Remove this file, then restart the application.

EventID: E802027D (hex)

Message: 638

"Incompatible CalSets found: <x> of <y> stored calsets have been loaded."

Severity: Error

Further explanation: Errors were found on some of the calsets stored in the calset file. The errors may have been caused by versioning issues that may have corrupted the various calset keys.

Suggestions: Use the calset viewer to look at the contents of calset files. Delete the files that are corrupted.

EventID: 6802027E (hex)

Message: 639

"The Calset file: <x> was not found. A new file has been created."

Severity: Informational

Further explanation: The calset file should be stored on the hard drive. When the application is started, a search is done and the file is loaded if it can be found. If the file is not found, the analyzer will create a new file and display this message.

Suggestions: None

EventID: 6802027F (hex)

Message: 640

"The Calset specified is currently in use."

Severity: Error

Further explanation: This may indicate a conflict between multiple calset users attempting calibration tasks.

Suggestions: Save the instrument state. Preset the analyzer and recall the instrument state. This may abort any processes that may be in progress.

EventID: E8020280 (hex)

Message: 641

"The calset specified has not been opened."

Severity: Error

Further explanation: Multiple users may be attempting to access the calset.

Suggestions: Close multiple calset users so that only one user will access the calset.

EventID: E8020281 (hex)

Message: 642

"The maximum number of cal sets has been reached. Delete old or unused cal sets before attempting to create new ones."

Severity: Error

Suggestions: You may also delete the calsets data file.

E5080A

The cal set file is stored in the application home directory. C:/Program Files/Keysight/Network_Analyzer/PNACalSets.dat. Remove this file, then restart the application.

EventID: E8020282 (hex)

Message: 643

The requested power loss table segment was not found.

Severity: Error

EventID: E8020283 (hex)

Message: 644

"A valid calibration is required before correction can be turned on."

Severity: Error

Further explanation: This usually indicates a calibration procedure has not run to completion or that the selected measurement does not have a valid calibration available from within the currently selected cal set.

Suggestions: To find a calibration, you can select a Cal Set that contains the calibration needed for the current measurements. This error can happen if a calibration type is not specified before attempting to programmatically execute cal acquisitions. Specify the cal type before beginning a calibration procedure.

EventID: E8020284 (hex)

Message: 645

The cal data for <x> is incompatible and was not restored. Please recalibrate."

Severity: Warning

Further explanation: None

Suggestions: None

EventID: A8020285 (hex)

Message: 646

"CalSet not loaded, version is too new."

Severity: Error

Further explanation: An old version of firmware is attempting to run with a new calset version. The version is incompatible.

Suggestions: The calset can be removed. You may also delete the calsets data file if you are migrating between various firmware revisions often and you would like to avoid this error. The cal set file is stored in the application home directory. C:/Program Files/Keysight/Network Analyzer/PNACalSets.dat. Remove this file, then restart the application.

EventID: E8020286 (hex)

Message: 647

"Custom cal type not found."

Severity: Error

Further explanation:

Suggestions:

EventID: E8020287 (hex)

Message: 648

"Custom correction algorithm defers to the client for interpolation."

Severity: Informational

EventID: 68020288 (hex)

Message: 649

"Custom cal dll threw an exception."

Severity: Error

EventID: E8020289 (hex)

Message: 650

"Could not load the ecal.dll library"

Severity: Error

EventID: E802028A (hex)

Message: 656

"The argument specified is not a valid cal type."

Severity: Error

EventID: E8020290 (hex)

Message: 657

"The function found existing interpolated data"

Severity: Informational

EventID: 68020291 (hex)

Message: 658

"The function computed new interpolation values."

Severity: Informational

EventID: 68020292 (hex)

Message: 659

"The source power measurement failed."

Severity: Error

Suggestions: Please check GPIB, power meter settings and sensor connections.

EventID: E8020293 (hex)

Message: 660

"Duplicate session found. Close session and retry."

Severity: Error

EventID: E8020294 (hex)

Message: 661

"The session does not exist. Open the session and try again."

Severity: Error

Further explanation:

EventID: E8020295 (hex)

Message: 662

"Attempt to launch a custom calibration failed."

Severity: Error

Further explanation:

EventID: E8020296 (hex)

E5080A

Message: 663

"Request to measure a cal standard failed."

Severity: Error

Further explanation: Please ensure you are requesting to measure standards which are defined for this calibration.

EventID: E8020297 (hex)

Message: 664

"Since Electronic Calibration Kit is selected, Mechanical Cal Kit parameter cannot be changed."

Severity: Error

Further explanation:

EventID: E8020298 (hex)

Message: 665

"Frequencies of the active channel are below minimum or above maximum frequencies of the ECal module factory characterization."

Suggestions: Change the channel frequencies, or select another ECal module.

Severity: Error

EventID: E8020299 (hex)

Message: 666

"Calset chosen for characterizing the ECal Module Ports %1 does not contain a calibration for VNA Ports %2."

Severity: Error

Suggestions: Go back to select another calset or to perform another cal.

EventID: E802029A (hex)

Message: 667

"ECal module only has sufficient memory remaining to store a maximum of %1 points in User Characterization %2."

Severity: Error

Suggestions: Decrease your number of points, or choose to overwrite another user characterization.

EventID: E802029B (hex)

Message: 668

Input values are non-monotonic. Cannot interpolate.

Severity: Error

EventID: E802029C (hex)

Message: 669

Interpolation target is out of range. Cannot interpolate.

Severity: Error

EventID: E802029D (hex)

Message: 670

Guided Calibration Error: <>

Severity: Error

EventID: E802029E (hex)

Message: 671

The first call to the guided calibration interface must be Initialize.

Severity: Error

EventID: E802029F (hex)

Message: 672

The selected thru cal method was not recognized.

Severity: Error

EventID: E80202A0 (hex)

Message: 673

Could not generate the error terms.

Severity: Error

EventID: E80202A1 (hex)

Message: 674

Guided calibration must be performed on the active channel

Severity: Error

EventID: E80202A2 (hex)

Message: 675

You can not start using calibration steps until you have successfully called generate steps.

Severity: Error

EventID: E80202A3 (hex)

Message: 676

The step number given is out of range. Step numbers should be between 1 and the number of steps. 0 is not a valid step number.

Severity: Error

EventID: E80202A4 (hex)

Message: 677

A calset was selected for channel: <n> without restoring stimulus.

Severity: Informational

EventID: 680202A5 (hex)

Message: 678

A calset was selected for channel: <n> restoring stimulus.

Severity: Informational

EventID: 680202A6 (hex)

Message: 679

The selected calset stimulus could not be applied to the channel.

Severity: Informational

EventID: 680202A7 (hex)

Message: 680

You attempted to measure power at a frequency outside the frequency range defined for the specified power sensor. Select another sensor or adjust the range for this sensor.

E5080A

Severity: Error

EventID: E80202A8 (hex)

Message: 681

Specified frequency is outside the frequency ranges currently defined for the power meter's sensors.

Severity: Error

EventID: E80202A9 (hex)

Message: 682

Additional Calibration Standards need to be acquired in order to calibrate over the entire frequency range currently being measured.

Severity: Informational

EventID: 680202AA (hex)

Message: 683

The VNA failed to convert cal kits for use by unguided calibrations. The recommended action is to restore Cal Kit defaults.

Severity: Error

EventID: E80202AB (hex)

Message: 684

The VNA failed to convert cal kits for use by unguided calibrations. CalKit defaults have been restored.

Severity: Error

EventID: E80202AC (hex)

Message: 685

Power meter is reserved by a source power cal acquisition already in progress.

Severity: Error

EventID: E80202AD (hex)

Message: 686

Source power calibration has not been performed or uploaded for the specified channel and source port.

Severity: Error

EventID: E80202AE (hex)

Message: 687

Source power calibration data array size for the specified channel and source port does not match it's associated stimulus number of points.

Severity: Error

EventID: E80202AF (hex)

Message: 688

Source power calibration of Port <n> on Channel <n> was turned off because the correction array no longer exists.

Severity: Error

EventID: E80202B0 (hex)

Message: 689

This command can only be used on a measurement created with a specified calibration loadport.

Severity: Error

EventID: E80202B1 (hex)

Message: 690

Interpolation is turned off and you have changed the stimulus settings of the original calibration, so correction has been turned off.

Severity: Error

EventID: E80202B2 (hex)

Message: 691

Stimulus settings for your current instrument state exceeded the parameters of the original calibration, so correction has been turned off.

Severity: Error

EventID: E80202B3 (hex)

Message: 692

Fixturing: the requested S2P file cannot be read. Possible formatting problem.

Severity: Error

EventID: E80202B4 (hex)

Message: 693

Fixturing: the requested S2P file cannot be opened.

Severity: Error

EventID: E80202B5 (hex)

Message: 694

Fixturing: the requested S2P file cannot be interpolated. This is usually because the frequency range in the file is a subset of the current channel frequency range.

Severity: Error

EventID: E80202B6 (hex)

Message: 695

Cal Registers can only be used by one channel: the channel conveyed in the name of the cal register. The name cannot be changed.

Severity: Error

Further explanation: See [Cal Registers](#)

EventID: E80202B7 (hex)

Message: 696

Fixturing: cannot be enabled with Response Calibrations and has been turned off.

Severity: Error

EventID: E80202B8 (hex)

Message: 697

The selected calibration cannot be performed for this measurement.

Severity: Error

EventID: E80202B9 (hex)

Message: 698

Fitting: RemoveAllConnectors() should be called prior to calling AddConnector after a fit has been attempted.

E5080A

Severity: Error

EventID: E80202BA (hex)

Message: 699

An attempt was made to acquire calibration data before the system was properly initialized.

Severity: Error

EventID: E80202BB (hex)

Message: 700

Use IGuidedCalibration for multipoint calibration types.

Severity: Error

EventID: E80202BC (hex)

Message: 701

Guided calibration requires number of thru measurement paths be at least equal to the number of calibration ports minus 1.

Severity: Error

EventID: E80202BD (hex)

Message: 702

A thru path was specified that includes a port which the calibration was not specified to include.

Severity: Error

EventID: E80202BE (hex)

Message: 703

One or more of the ports to be calibrated was not found in the set of specified thru paths.

Severity: Error

EventID: E80202BF (hex)

Hardware Errors

Message: 770

Input power too high. Source power is off.

Severity: Warning

EventID: A8030302 (hex)

Message: 771

Source power restored.

Severity: Informational

EventID: 68030303 (hex)

Message: 772

"The spampnp.sys driver is not working. Check system hardware. ! Data will be simulated. !"

Severity: Error

Further explanation: The Network Analyzer application cannot locate the DSP board. Hardware or a driver may be malfunctioning. This is also common when attempting to run the Network Analyzer on a workstation.

EventID: E8030304 (hex)

Message: 773

"Instrument Serial Bus Not Working."

Severity: Error

Further explanation: The instrument EEPROM appears to contain either all ones or all zeros. A serial bus hardware failure prevents reading the EEPROM.

EventID: E8030305 (hex)

Message: 784

Unleveled, source <n>, out <n>.

Severity: Error

Further explanation: The VNA was unable to set the power on port <n> to the desired level

Message: 848

"Phase lock lost"

Severity: Error

Further explanation: The instrument source was not able to lock properly. This can be the result of broken hardware, poor calibration, or bad EEPROM values.

Suggestions: Perform source calibration. Click System / Service / Adjustments / Source Calibration

EventID: E8030350 (hex)

Message: 849

Phaselock restored.

Severity: Success

EventID: 0x28030351 (hex)

Message: 850

"Unknown hardware error."

Severity: Error

Further explanation: Hardware malfunctioned prevents communication with the DSP.

EventID: E8030352 (hex)

Message: 851

DSP communication lost.

Severity: Error

EventID: E8030353 (hex)

Message: 852

RF power off.

Severity: Error

EventID: E8030354 (hex)

Message: 853

RF power on.

Severity: Success

EventID: 28030355 (hex)

Message: 854

Hardware OK.

E5080A

Severity: Success

EventID: 28030356 (hex)

Message: 855

"Source unlevelled."

Severity: Error

Further explanation: The source was unable to properly level at the requested power. The indicated power may not be accurate.

Suggestions: Try a different power level. Recalibrate source, if problem persists.

EventID: E8030357 (hex)

Message: 856

Source leveled.

Severity: Success

EventID: 28030358 (hex)

Message: 857

Input overloaded.

Severity: Error

EventID: E8030359 (hex)

Message: 858

Input no longer overloaded.

Severity: Success

EventID: 2803035A (hex)

Message: 859

"Yig calibration failed."

Severity: Error

Further explanation: Internal self-calibration of YIG oscillator tuning failed.

EventID: E803035B (hex)

Message: 860

Yig calibrated.

Severity: Success

EventID: 2803035C (hex)

Message: 861

"Analog ramp calibration failed."

Severity: Error

Further explanation: Internal analog sweep ramp calibration has failed.

EventID: E803035D (hex)

Message: 862

Analog ramp calibrated.

Severity: Success

EventID: 2803035E (hex)

Message: 863

Source temperature high.

Severity: Error

EventID: E803035F (hex)

Message: 864

Source temperature OK.

Severity: Success

EventID: 28030360 (hex)

Message: 865

"EEPROM write failed."

Severity: Error

Further explanation: Attempt to store calibration data to EEPROM has failed. There is a possible hardware failure.

EventID: E8030361 (hex)

Message: 866

EEPROM write succeeded.

Severity: Success

EventID: 28030362 (hex)

Message: 867

Attempted I/O write while port set to read only.

Severity: Error

Further explanation: Attempt to write to an I/O data port while the port set to input/read only.

Suggestions: Set data port to write/output before attempting to write to port.

EventID: E8030363 (hex)

Message: 868

" Attempted I/O read from write only port.

Severity: Error

Further explanation: Attempt to read from an I/O data port while the port set to output/write only.

Suggestions: Set data port to read/input before attempting to read from port.

EventID: E8030364 (hex)

Message: 869

Invalid hardware element identifier.

Severity: Error

EventID: E8030365 (hex)

Message: 870

Invalid gain level setting.

Severity: Error

EventID: E8030366 (hex)

Message: 871

Device driver was unable to allocate enough memory. Please try rebooting.

Severity: Error

E5080A

EventID: E8030367 (hex)

Message: 872

DSP Error. Please Contact Keysight Support. Technical Information: DSP Type 1

Severity: Error

EventID: E8030368 (hex)

Message: 873

DSP Error. Please Contact Keysight Support. Technical Information: DSP Type 2

Severity: Error

EventID: E8030369 (hex)

Message: 874

DSP Error. Please Contact Keysight Support. Technical Information: DSP Type 3

Severity: Error

EventID: E803036A (hex)

Message: 875

DSP Error. Please Contact Keysight Support. Technical Information: DSP Type 4

Severity: Error

EventID: E803036B (hex)

Message: 876

DSP Error. Please Contact Keysight Support. Technical Information: DSP Type 5

Severity: Error

EventID: E803036C (hex)

Message: 910

The trigger connection argument was not recognized as valid by the firmware.

Severity: Error

EventID: 0xE803038E (hex)

Message: 911

The trigger connection specified does not support this trigger behavior

Severity: Error

EventID: E803038F (hex)

Message: 912

The trigger behavior specified was not recognized as valid by the firmware.

Severity: Error

EventID: E8030390 (hex)

Message: 913

The trigger connection specified does not physically exist on this network analyzer

Severity: Error

EventID: E8030391 (hex)

Message: 914

Cannot set "Accept Trigger Before Armed", since this hardware configuration does not support edge triggering.

Severity: Error

EventID: E8030392 (hex)

Message: 915

Cannot set "Trigger Output Enabled", since this hardware configuration does not support BNC2.

Severity: Error

EventID: E8030393 (hex)

Message: 916

Exceeded maximum trigger delay.

Severity: Error

EventID: E8030394 (hex)

Message: 917

Exceeded minimum trigger delay.

Severity: Error

EventID: E8030395 (hex)

Measure Errors

Message: 1024

If you are going to display or otherwise use a memory trace, you must first store a data trace to memory.

Severity: Warning

EventID: A8040400 (hex)

Message: 1025

"The measurement failed to shut down properly. The application is in a corrupt state and should be shut down and restarted."

Severity: Error

Further explanation: This message is displayed if the VNA application becomes corrupt. If you continue to get this error, please call customer service

EventID: E8040401 (hex)

Message: 1026

The measurement failed to shut down properly. The update thread failed to exit properly.

Severity: Warning

EventID: A8040402 (hex)

Message: 1027

"Group Delay format with CW Time or Power sweeps produces invalid data."

Severity: Warning

Further explanation: Group Delay format is incompatible with single-frequency sweeps. Invalid data is produced.

Suggestions: Ignore the data or choose a different format or sweep type.

EventID: A8040403 (hex)

Message: 1028

Severity: Informational

E5080A

"MSG_LIMIT_FAILED"

Further explanation: Limit line test failed.

EventID: 68040404 (hex)

Message: 1029

Severity: Informational

"MSG_LIMIT_PASSED"

Further explanation: Limit line test passed.

EventID: 68040405 (hex)

Message: 1030

"Exceeded the maximum number of measurements allowed."

Severity: Warning

Further explanation: See [Traces, Channels, and Windows on the VNA](#) for learn about maximum measurements.

EventID: A8040406 (hex)

Message: 1031

"Network Analyzer Internal Error. Unexpected error in AddNewMeasurement."

Severity: Warning

Further explanation: If you continue to get this message, contact product support.

EventID: A8040407 (hex)

Message: 1032

"No measurement was found to perform the selected operation. Operation not completed."

Severity: Warning

Further explanation: None

Suggestions: Create a measurement before performing this operation.

EventID: A8040408 (hex)

Message: 1033

The Markers All Off command failed.

Severity: Warning

EventID: A8040409 (hex)

Message: 1034

"A memory trace has not been saved for the selected trace. Save a memory trace before attempting trace math operations."

Severity: Warning

Further explanation: Must have a memory trace when trying to do Trace Math,

EventID: A804040A (hex)

Message: 1035

"MSG_SET_AVERAGE_COMPLETE"

Severity: Informational

Further explanation: Informational for COM programming. Averaging factor has been reached.

EventID: 6804040B (hex)

Message: 1036

"MSG_CLEAR_AVERAGE_COMPLETE"

Further explanation: Informational for COM programming. Averaging factor has NOT been reached.

EventID: 6804040C (hex)

Message: 1037

"Time Domain transform requires at least 3 input points. The transform has been deactivated."

Severity: Informational

Further explanation: None

Suggestions: Increase the number of points.

EventID: 6804040D (hex)

Message: 1038

Smoothing requires a scalar format, and has been deactivated.

Severity: Informational

EventID: 6804040E (hex)

Message: 1039

A receiver power calibration in this instrument state file cannot be recalled into this firmware version.

Severity: Warning

EventID: A804040F (hex)

Message: 1047

Could not achieve target power.

Severity: Error

Further explanation: This indicates that the VNA was unable to find a source power during the THRU step of the cal sufficiently high to boost the measured noise power on port 2 to 6 dB above the noise floor.

Message: 1104

"Exceeded limit on number of measurements."

Severity: Error

Further explanation: See [Traces, Channels, and Windows on the VNA](#) for measurement limits.

EventID: E8040450 (hex)

Message: 1105

"Parameter not valid."

Severity: Error

Further explanation: A measurement parameter that was entered programmatically is not valid.

EventID: E8040451 (hex)

Message: 1106

"Measurement not found."

Severity: Error

Further explanation: Any of these could be the cause:

Trying to calibrate but already have maximum measurements.

Trying to do a confidence check but there is not a measurement.

E5080A

Trying to create, activate, or alter a measurement through COM that has been deleted through the front panel.

Trying to use a trace name through programming that is not unique.

EventID: E8040452 (hex)

Message: 1107

"No valid memory trace."

Severity: Error

Further explanation: Must have a memory trace when trying to do Trace Math,

Suggestions: Store a memory trace.

EventID: E8040453 (hex)

Message: 1108

"The reference marker was not found."

Severity: Error

Further explanation: Attempted to create a delta marker without first creating a reference marker (COM only).

EventID: E8040454 (hex)

Message: 1109

"Data and Memory traces are no longer compatible. Trace Math has been turned off."

Severity: Error

Further explanation: Warning - channel setting has changed while doing trace math.

Suggestions: Store another memory trace and turn trace math back on.

EventID: A8040455 (hex)

Message: 1110

"Data and Memory traces are not compatible. For valid trace math operations, memory and data traces must have similar measurement conditions."

Severity: Error

Further explanation: Tried to do trace math without compatible data and memory traces.

Suggestions: Store another memory trace.

EventID: E8040456 (hex)

Message: 1111

"Marker Bandwidth not found."

Severity: Error

Further explanation: Could not find a portion of trace that meets the specified bandwidth criteria.

EventID: E8040457 (hex)

Message: 1112

"The peak was not found."

Severity: Error

Further explanation: Could not find portion of trace that meets peak criteria.

Suggestions: See Marker Peak criteria.

EventID: E8040458 (hex)

Message: 1113

"The target search value was not found."

Severity: Error

Further explanation: Could not find interpolated data point that meets search value.

EventID: E8040459 (hex)

Message: 1114

"Reflection measurement, such as S11, must supply an auxiliary port to disambiguate 2-port measurements on multiport instruments."

Severity: Error

Further explanation:

EventID: E804045A (hex)

Message: 1115

"The receiver power calibration has been turned off because the type of measurement or source port has changed, so the calibration is no longer valid."

Severity: Warning

Further explanation:

EventID: A804045B (hex)

Message: 1116

"Receiver power cal requires the active measurement to be of unratiod power."

Severity: Warning

Further explanation:

EventID: A804045C (hex)

Message: 1117

"There is currently no source power calibration associated with the channel and source port of the active measurement. A source power cal should be performed or recalled before performing a receiver power calibration."

Severity: Warning

Further explanation:

EventID: A804045D (hex)

Message: 1118

"The attempted operation can only be performed on a standard measurement type."

Severity: Error

Further explanation:

EventID: E804045E (hex)

Message: 1119

"The custom measurement cannot be loaded because it is not compatible with the Network Analyzer hardware."

Severity: Error

Further explanation:

Suggestions:

EventID: E804045F (hex)

E5080A

Message: 1120

"The custom measurement cannot be loaded because it is not compatible with the Network Analyzer software."

Severity: Error

Further explanation:

EventID: E8040460 (hex)

Message: 1121

"The custom measurement load operation failed for an unspecified reason."

Severity: Error

Further explanation:

EventID: E8040461 (hex)

Message: 1122

"The custom measurement data processing has generated an unhandled exception, and will be terminated. The VNA software may be in an unstable state and it is recommended that the VNA software be shutdown and restarted."

Severity: Error

Further explanation:

EventID: E8040462 (hex)

Message: 1123

"The attempted operation can only be performed on a custom measurement type."

Severity: Error

Further explanation:

EventID: E8040463 (hex)

Message: 1124

"The requested custom measurement is not available."

Severity: Error

Further explanation:

EventID: E8040464 (hex)

Message: 1125

"The requested custom algorithm was not found."

Severity: Error

Further explanation:

EventID: E8040465 (hex)

Message: 1126

"Normalization cannot be turned on because the measurement does not have a valid divisor buffer."

Severity: Error

Further explanation:

EventID: E8040466 (hex)

Message: 1127

"The Raw Data requested by the measurement could not be provided."

Severity: Warning

Further explanation:**EventID:** A8040467 (hex)**Message:** 1128

"The selected Sweep Type does not allow Transform and Gating. Transform and Gating disabled. "

Severity: Error**Further explanation:****EventID:** E8040468 (hex)**Message:** 1129

Memory trace can not be applied to this measurement

Severity: Error**EventID:** E8040469 (hex)**Message:** 1130

Normalization can not be applied to this measurement

Severity: Error**EventID:** E804046A (hex)**Message:** 1131

The data provided has an invalid number of points. It could not be stored

Severity: Error**EventID:** E804046B (hex)**Message:** 1132

The measurement stored in the save/recall state has an invalid version. It could not be loaded

Severity: Error**EventID:** E804046C (hex)**Message:** 1133

This data format argument for this operation must be "naDataFormat_Polar"

Severity: Error**EventID:** E804046D (hex)**Message:** 1134

This data format argument for this operation must be a scalar data format

Severity: Error**EventID:** E804046E (hex)**Message:** 1135

The memory trace is not valid for the current measurement setup.

Severity: Error**EventID:** E804046F (hex)**Message:** 1136

This measurement is incompatible with existing measurements in this channel. Choose another channel.

Severity: Error**EventID:** E8040470 (hex)**Message:** 1137

Port extension correction is not available for offset frequency measurements. Port extension correction has been disabled.

Severity: Error

EventID: E8040471 (hex)

Message: 1138

Physical port number assignments for logical port mappings must be unique.

Severity: Error

EventID: E8040472 (hex)

Parser Errors

Message: 1281

"You have sent a read command to the analyzer without first requesting data with an appropriate output command. The analyzer has no data in the output queue to satisfy the request."

Severity: Error

EventID: 68050501 (hex)

Message: 1282

"You must remove the active controller from the bus or the controller must relinquish the bus before the analyzer can assume the system controller mode."

Severity: Error

EventID: E8050502(hex)

Message: 1283

"The analyzer did not receive a complete data transmission. This is usually caused by an interruption of the bus transaction."

Severity: Error

EventID: E8050503 (hex)

Message: 1284

"The instrument status byte has changed."

Severity: Informational

EventID: 68050504 (hex)

Message: 1285

"The SCPI command received has caused error number %1: "%2"."

Severity: Informational

EventID: 68050505 (hex)

Message: 1286

"The INET LAN server has been started as process number %1."

Severity: Informational

EventID: 68050506 (hex)

Message: 1360

"Execution of the SCPI command has failed"

Severity: Error

EventID: E8050550 (hex)

Message: 1361

" The INET/LAN device is not accessible."

Severity: Error

EventID: E8050551 (hex)

Message: 1362

"The INET/LAN driver was not found. "

Severity: Error

EventID: E8050552 (hex)

Message: 1363

"The INET/LAN driver was not found."

Severity: Error

EventID: E8050553 (hex)

Message: 1364

"The INET/LAN device is unable to acquire the necessary resources. "

Severity: Error

EventID: E8050554 (hex)

Message: 1365

"The INET/LAN device generated a generic system error. "

Severity: Error

EventID: E8050555 (hex)

Message: 1366

"Invalid address for the INET/LAN device."

Severity: Error

EventID: E8050556 (hex)

Message: 1367

"The INET I/O library was not found. "

Severity: Error

EventID: E8050557 (hex)

Message: 1368

"An error occurred in the INET system. "

Severity: Error

EventID: E8050558 (hex)

Message: 1369

"Access to the INET/LAN driver was denied. "

Severity: Error

EventID: E8050559 (hex)

Message: 1370

"Could not load error system message dll."

Severity: Error

E5080A

EventID: E805055A (hex)

Message: 1371

"ErrorSystemMessage.dll does not export the right function."

Severity: Error

EventID: E805055B (hex)

Message: 1372

"Custom scpi library was not able to be knitted"

Severity: Error

EventID: E805055C (hex)

Message: 1373

"Could not knit the scpi error messages from the ErrorSystemMessage lib"

Severity: Error

EventID: E805055D (hex)

Message: 1374

Command is obsolete with this software version.

Severity: Error

EventID: E808055E (hex)

Message: 1375

CALC measurement selection set to none. Use [Calc:Par:Sel](#)

Severity: Error

EventID: E808055F (hex)

Message: 1535

"Parser got command: %1."

Severity: Informational

EventID: 680505FF (hex)

Display Errors 1536 - 1621

Message: 1536

"Exceeded the maximum of 4 traces in each window. The trace for <x> will not be added to window <x>."

Severity: Warning

Further explanation: None

Suggestions: Create the trace in another window. See the [VNA window limits](#).

EventID: A8060600 (hex)

Message: 1537

"Exceeded the maximum of 16 data windows. New window will not be created."

Severity: Warning

Further explanation: None

Suggestions: Create the trace in an existing window. See the [VNA window limits](#).

EventID: A8060601 (hex)

Message: 1538

"No Data Windows are present. Unable to complete operation."

Severity: Warning

Further explanation: Your remote SCPI operation tried to create a new measurement while there were no windows present

Suggestions: Create a new window before creating the measurement. See example [Create a measurement using SCPI](#)

EventID: A8060602 (hex)

Message: 1539

"No data traces are present in the selected window. Operation not completed."

Severity: Warning

Further explanation: None

EventID: A8060603 (hex)

Message: 1540

"Cannot complete request to arrange existing measurements in <x> windows due to the limit of <x> traces per window."

Severity: Informational

Further explanation: The arrange window feature cannot put the existing traces into the number of windows you requested because only 4 traces per window are allowed. See Arranging Existing Measurements

Suggestions: Either create more windows or delete some traces.

EventID: 68060604 (hex)

Message: 1541

"Unable to establish a connection with the specified printer."

Severity: Warning

Further explanation: None

Suggestions: Refer to Printer Help

EventID: A8060605 (hex)

Message: 1542

"Printout canceled."

Severity: Informational

EventID: 68060606 (hex)

Message: 1616

"Window not found."

Severity: Error

Further explanation: A window was specified in your program which does not exist.

Suggestions: Query the name of your window before specifying.

EventID: E8060650 (hex)

Message: 1617

"Duplicate window ID specified."

Severity: Error

E5080A

Further explanation: None

EventID: E8060651 (hex)

Message: 1618

"Exceeded limit on number of windows."

Severity: Error

Further explanation: There is a limit of 4 windows per screen.

EventID: E8060652 (hex)

Message: 1619

"Exceeded limit on number of traces/window."

Severity: Error

Further explanation: There is a limit of 4 traces per window. See the [Traces, Channels, and Windows on the VNA](#).

Suggestions: Create the trace in another window

EventID: E8060653 (hex)

Message: 1620

"Trace not found."

Severity: Error

Further explanation: Your program tried to communicate with a non-existing trace.

Suggestions:Query the trace ID before writing to it.

EventID: E8060654 (hex)

Message: 1621

"The operating system does not recognize this printer."

Severity: Warning

EventID: A8060655 (hex)

Message: 1622

Duplicate trace ID specified.

Severity: Error

EventID: E8060656 (hex)

Channel Errors 1792 -1878

Message: 1792

"Sweep Complete."

Severity: Informational

Further explanation: None

Suggestions:None

EventID: 68070700 (hex)

Message: 1793

"All triggerable acquisitions have completed."

Severity: Informational

Further explanation:**EventID:** 68070701 (hex)**Message:** 1794

"The last trigger produced an aborted sweep."

Severity: Informational**Further explanation:****EventID:** 68070702 (hex)**Message:** 1795

"The segment list must be adjusted to have at least one active segment with more than 0 points to use segment sweep."

Severity: Informational

Further explanation: You attempted to change **Sweep type** to Segment sweep, but there is either no segments defined or no sweep points in the defined segments

Suggestions: Define at least one segment with at least one measurement point. See Segment sweep for more information

EventID: 68070703 (hex)**Message:** 1796

"MSG_SET_CHANNEL_DIRTY"

Severity: Informational

Further explanation: This informational message occurs when a channel setting has changed but the channel still has data that was taken with the previous setting. The following CLEAR message occurs when new channel data is taken.

EventID: 68070704 (hex)**Message:** 1797

"MSG_CLEAR_CHANNEL_DIRTY"

Severity: Informational

Further explanation: The previous SET message occurs when a channel setting has changed but the channel still has data that was taken with the previous setting. This CLEAR message occurs when new channel data is taken.

EventID: 68070705 (hex)**Message:** 1798

Sweep time has changed from Auto to Manual mode. If desired to return to Auto mode, enter sweep time value of 0.

Severity: Informational**EventID:** 68070706 (hex)**Message:** 1799

"Set Sweep Completed"

Severity: Informational

Further explanation: This event occurs when a sweep and it's associated sweep calculations finish. This is typically when all sweeps on a channel complete.

EventID: 68070707 (hex)**Message:** 1800

E5080A

"Clear Sweep Completed"

Severity: Informational

Further explanation: This event occurs immediately after the SET SWEEP COMPLETED event. These two events set and clear the "Sweep Completed" bit (bit 4) on the SCPI Device Status register.

EventID: 68070708 (hex)

Message: 1801

"All Sweeps Completed and Processed"

Severity: Informational

Further explanation: This event occurs when all of the sweeps and sweep calculations are complete for a channel.

EventID: 68070709 (hex)

Message: 1802

Low Pass : Frequency limits have been changed.

Severity: Informational

EventID: 6807070A (hex)

Message: 1803

Low Pass : Number of points have been changed.

Severity: Informational

EventID: 6807070B (hex)

Message: 1804

Low Pass : Frequency limits and number of points have been changed.

Severity: Informational

EventID: 6807070C (hex)

Message: 1805

"Channel created"

Severity: Informational

EventID: 6807070D (hex)

Message: 1806

"Channel deleted"

Severity: Informational

EventID: 6807070E (hex)

Message: 1872

"Channel not found."

Severity: Error

Further explanation: A non-existent channel is being referenced under program control.

Suggestions: Query the channel number, then refer to it by number.

EventID: E8070750 (hex)

Message: 1873

"The requested sweep segment was not found."

Severity: Error

Further explanation: A non-existent sweep segment is being referenced under program control.

EventID: E8070751 (hex)

Message: 1874

"The sweep segment list is empty."

Severity: Error

Further explanation: Segment Sweep cannot be specified unless there is at least one defined segment. This error will only occur under remote control.

EventID: E8070752 (hex)

Message: 1875

"The number of points in active sweep segment list segments is 0."

Severity: Error

Further explanation: Segment Sweep cannot be specified unless there is at least data point specified in a segment. This error will only occur under remote control.

EventID: E8070753 (hex)

Message: 1876

"The specified source attenuator is not valid."

Severity: Error

Further explanation: You tried to set the Attenuator property on the Channel object on a VNA that doesn't have a source attenuator.

EventID: E8070754 (hex)

Message: 1877

"Log Frequency sweep cannot be selected with the current Number of Points. Please reduce Number of Points."

Severity: Error

Further explanation: The maximum number of points that can be used for Log sweep is 401.

EventID: E8070755 (hex)

Message: 1878

"The requested Number of Points is greater than can be selected for Log Frequency sweep."

Severity: Error

Further explanation: The maximum number of points that can be used for Log sweep is 401.

EventID: E8070756 (hex)

Message: 1879

"Response frequencies exceeded instrument range so Frequency Offset has been turned off."

Severity: Error

Further explanation: This error is returned whenever the instrument detects that the stimulus sweep setup and Frequency Offset settings result in computed response frequencies that exceed instrument limits. When this occurs, the instrument automatically turns off Frequency Offset to avoid the out-of-range conditions.

Suggestions: When this condition has occurred, change settings for either the stimulus frequencies or Frequency Offset so that the Response frequencies are within instrument bounds. Once this is done, Frequency Offset can once again be turned on.

EventID: E8070757 (hex)

E5080A

Message: 1880

The total number of points for all the given segments exceeds the maximum number of points supported. The segments were not changed.

Severity: Error

EventID: E8070758 (hex)

Message: 1881

This instance of the Channels object was not used to place the channels in Hold, so no channels were resumed.

Severity: Error

EventID: E8070759 (hex)

Message: 1882

The port number was outside the range of allowed port numbers.

Severity: Error

EventID: E807075A (hex)

Message: 1883

More ports than are present are required for this operation.

Severity: Error

EventID: E807075B (hex)

General Errors

Message: 2048

"The function you requested requires a capability provided by an option to the standard analyzer. That option is not currently installed."

Severity: Error

Further explanation: None

Suggestions: To view the options on your analyzer, click **Help / About Network Analyzer**. For more information see VNA Options

EventID: 68080800 (hex)

Message: 2049

"The feature you requested is not available on the current instrument."

Severity: Error

Further explanation: None

EventID: 68080801 (hex)

Message: 2050

"The feature you requested is incompatible with the current instrument state."

Severity: Error

Further explanation: None

Suggestions: None

EventID: 68080802 (hex)

Message: 2051

"File<x> has been saved."

Severity: Informational

Further explanation: None

EventID: 68080803 (hex)

Message: 2052

"Attempt to save <x> failed."

Severity: Error

Further explanation: None

Suggestions: If using a floppy disk, ensure it is inside the drive and the disk is not full. Check the filename for special characters.

EventID: E8080804 (hex)

Message: 2053

"Attempt to recall file failed because <x> was not found."

Severity: Error

Further explanation: None

EventID: E8080805 (hex)

Message: 2054

"<x> has a bad header."

Severity: Error

Further explanation: None

Suggestions: Recopy the file and / or delete the file.

EventID: E8080806 (hex)

Message: 2056

"Request to enter hibernate state."

Further explanation: None

EventID: 68080808 (hex)

Message: 2057

"Power up from automatic hibernate state. Program received PBT_APMRESUMEAUTOMATIC Message."

Further explanation: None

EventID: 68080809 (hex)

Message: 2058

"Power up from suspend hibernate state. Program received PBT_APMRESUMESUSPEND Message."

Further explanation: None

EventID: 6808080A (hex)

Message: 2059

"Power up from suspend hibernate state. Program received PBT_APMRESUMECRITICAL Message."

Severity: Warning

Further explanation: None

EventID: A808080B (hex)

Message: 2060

"Power up from unknown hibernate state UI recovery called. Program received no PBT_Message within the time allotted and is attempting recovery."

Severity: Warning

Further explanation: None

EventID: A808080C (hex)

Message: 2061

"<x> already exists. File is being overwritten."

Further explanation: Used only for remote applications

EventID: 6808080D (hex)

Message: 2062

"File has not been saved."

Severity: Error

Further explanation: Used only for remote applications

EventID: E808080E (hex)

Message: 2063

"File <x> has been recalled."

Further explanation: Used only for remote applications

EventID: 6808080F (hex)

Message: 2064

"State version in <x> is considered obsolete by this version of this code."

Severity: Error

Further explanation: You attempted to recall a file that is no longer valid.

Suggestions: You must recreate the file manually.

EventID: E8080810 (hex)

Message: 2065

"State version in <x> is newer than the latest version supported by this code."

Severity: Error

Further explanation: You attempted to recall a file that was created by a later version of the VNA application.

Suggestions: You must recreate the file manually.

EventID: E8080811 (hex)

Message: 2066

"Error occurred while reading file <x>"

Severity: Error

Further explanation: The file may be corrupt.

Suggestions: Try to recreate the file.

EventID: E8080812 (hex)

Message: 2067

"Windows shell error: <x>"

Severity: Error

Further explanation: None

EventID: E8080813 (hex)

Message: 2068

Send message timed out returning: <x>.

Severity: Error

Further explanation: None

EventID: E8080814 (hex)

Message: 2069

"Changing GPIB mode to System Controller."

Severity: Informational

Further explanation: None

EventID: 68080815 (hex)

Message: 2070

"Changing GPIB mode to Talker Listener."

Severity: Informational

Further explanation: None

EventID: 68080816 (hex)

Message: 2071

"The Network Analyzer can not be put in GPIB System Controller mode until the GPIB status is Local. Stop any remote GPIB programs which may be using the Network analyzer, press the Macro/Local key and try again. "

Severity: Informational

Further explanation: See [LCL and RMT Operation](#)

Suggestions: Press the Macro/Local key and try again.

EventID: 68080817 (hex)

Message: 2120

"This method can not be invoked through a late-bound COM call."

Severity: Error

Further explanation: None

Suggestions: Use the alternate method described in the COM programming documentation

EventID: E8080878 (hex)

Message: 2128

"The specified format is invalid."

Severity: Error

Further explanation: None

EventID: E8080850 (hex)

Message: 2129

"WINNT exception caught by Automation layer."

Severity: Error

Further explanation: None

E5080A

EventID: E8080851 (hex)

Message: 2130

"Bad port specification."

Severity: Error

Further explanation: None

EventID: E8080852 (hex)

Message: 2131

"Failed to find a printer."

Severity: Error

Further explanation: None

Suggestions: See [Connecting to a Printer](#)

EventID: E8080853 (hex)

Message: 2132

"Manual trigger ignored."

Severity: Error

Further explanation: None

EventID: E8080854 (hex)

Message: 2133

"Attempt to set trigger failed."

Severity: Error

Further explanation: None

EventID: E8080855 (hex)

Message: 2134

"Macro execution failed."

Severity: Error

Further explanation: None

EventID: E8080856 (hex)

Message: 2135

"Specified macro definition is incomplete."

Severity: Error

Further explanation:

EventID: E8080857 (hex)

Message: 2137

"Block data length error."

Severity: Error

Further explanation: See [Getting Data from the Analyzer](#)

EventID: E8080859 (hex)

Message: 2139

"Requested data not found."

Severity: Error

Further explanation: None

EventID: E808085B (hex)

Message: 2142

"The parameter supplied was out of range, so was limited to a value in range before being applied to the instrument."

Severity: Success

Further explanation: None

Suggestions: View range limits before sending programming commands.

EventID: 2808085E (hex)

Message: 2143

The parameter supplied was out of range, so was limited to a value in range before being applied to the instrument.

Severity: Error

EventID: E808085F (hex)

Message: 2144

"Request failed. The required license was not found."

Severity: Error

Further explanation: None

EventID: E8080860 (hex)

Message: 2145

"A remote call to the front panel has returned hresult <x>"

Severity: Error

Further explanation: This may indicate a problem with the front panel

Suggestions: Contact Technical support

EventID: E8080861 (hex)

Message: 2146

The recall operation failed.

Severity: Error

Further explanation:

EventID: E8080862 (hex)

Message: 2147

Attempt to save file failed.

Severity: Error

Further explanation:

EventID: E8080863 (hex)

Message: 2148

Recall attempt failed because file was not found.

Severity: Error

Further explanation:

EventID: E8080864 (hex)

E5080A

Message: 2149

Recall file has a bad header.

Severity: Error

Further explanation:

EventID: E8080865 (hex)

Message: 2150

Recall file version is obsolete and no longer compatible with this instrument.

Severity: Error

Further explanation:

EventID: E8080866 (hex)

Message: 2151

The recall file contains an istate version newer than this instrument. A remote call to the front panel has returned hresult %1

Severity: Error

Further explanation:

EventID: E8080867 (hex)

Message 2152

"Front Panel <x>

Severity: Error

Further explanation: None

EventID: E8080868 (hex)

Message 2153

"Front Panel message"

Severity: Informational

Further explanation: None

EventID: 68080869 (hex)

Message 2154

"Power Service <x>

Severity: Error

Further explanation: There is more than 1 instance of powerservice running. There should only be one running. This might happen after running install shield - especially when upgrading the CPU board.

Suggestions: Try rebooting. If this persists, please call [Customer Support](#).

EventID: E808086A (hex)

Message 2155

"Power Service <x>

Severity: Informational

Further explanation: None

EventID: 6808086B (hex)

Message 2156

"The Keysight Technologies GPIB driver can not be loaded or unloaded."

Severity: Error

Further explanation: None

Suggestions: If the problem persists, from the VNA desktop, right-click on My Computer. Click Properties, Click Hardware Tab. Click Device Manager Button. Expand GPIB Devices. Right-click and click Uninstall all GPIB interfaces devices. Reboot the VNA.

EventID: E808086C (hex)

Message 2157

"The National Instruments GPIB driver can not be loaded or unloaded."

Severity: Error

Further explanation: None

Suggestions: If the problem persists, from the VNA desktop, right-click on My Computer. Click Properties, Click Hardware Tab. Click Device Manager Button. Expand GPIB Devices. Right-click and click Uninstall all GPIB interfaces devices. Reboot the VNA.

EventID: E808086D (hex)

Message 2158

"The Keysight GPIB driver is loaded but it can not start its parser."

Severity: Error

Further explanation: None

EventID: E808086E (hex)

Message: 2159

The front panel is in remote mode.

Severity: Warning

EventID: A808086F (hex)

Message: 2160

The Registry Key specified could not be found.

Severity: Error

EventID: E8080870 (hex)

Message: 2161

An overcurrent condition has been detected on a probe plugged into the front panel.

Severity: Warning

EventID: A8080871 (hex)

Message: 2162

The operation timed out.

Severity: Error

EventID: E8080872 (hex)

Message 2163

"The Network Analyzer executed a preset."

Severity: Informational

Further explanation: None

EventID: 68080873 (hex)

Message 2164

"Access to file denied."

Severity: Error

Further explanation: This means that the system can not open an output file for writing. Most likely because the file is write protected.

Suggestions: Pick another file name or file directory, check floppy disk hard disk write access.

EventID: E8080874 (hex)

Message 2165

"File type is structured storage."

Severity: Informational

Further explanation: None

EventID: 68080875 (hex)

Message 2166

"The trigger operation failed."

Severity: Error

Further explanation: None

EventID: E8080876 (hex)

Message 2167

"Argument out of range error."

Severity: Error

Further explanation: None

Suggestions: None

EventID: E8080877 (hex)

Message: 2169

The given COM object is not a custom application

Severity: Error

EventID: E8080879 (hex)

Message: 2170

The eventID supplied was not recognized as a valid VNA eventID

Severity: Error

EventID: E808087A (hex)

Message: 2171

The operation was canceled.

Severity: Error

EventID: E808087B (hex)

Message: 2172

High security level cannot be disabled directly. Only an instrument preset or recall of lower security instrument state will reset this security level.

Severity: Error

EventID: E808087C (hex)

Message: 2173

Local lockout mode is on. The VNA application will not accept input from front panel, keyboard or mouse until this mode is turned off from a remote interface.

Severity: Error

EventID: E808087D (hex)

Message: 2174

The SnP request is not valid for the selected measurement.

Severity: Error

EventID: E808087E (hex)

Message: 2175

Preset is not supported while this dialog or wizard is open. Close the dialog or wizard and then try again.

Severity: Error

EventID: E808087F (hex)

Message: 2176

The function you requested requires a capability provided by an option to the standard analyzer. That option is not currently installed.

Severity: Error

EventID: E8080880 (hex)

Message: 2177

Catastrophic error. Crash dump recorded at <n>

Severity: Error

EventID: E8080881 (hex)

Message: 2178

In the context of a noise calibration, this would occur if the VNA was unable to set the state of the tuner Ecal module.

Severity: Error

EventID: E8080882 (hex)

Message: 2179

Failed to open gen.lic.

Severity: Error

EventID: E8080883 (hex)

Last modified:

29-Sep-2015 First Release



About Error Messages

VNA errors and Operating System errors are displayed and logged in an error file. You can choose how to display VNA errors, or choose to not display VNA errors at all.

- [Error Display](#)
- [View Error Log](#)
- [List of VNA Errors](#)
- [SCPI Errors](#)

Other System topics

Error Display

By default, error messages appear on the status bar. You can choose to have them stay on the screen until you click an OK button, or have them not appear at all. When they stay on the screen, a Help button is available to provide further assistance.

How to select the display of Error Messages

Using **Hardkey/SoftTab/Softkey**

1. Press **System** > **Help** > **Error Display...**

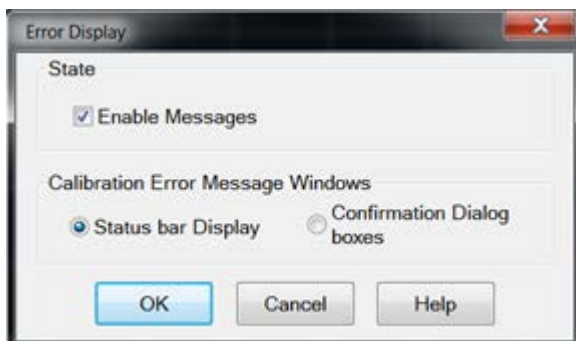
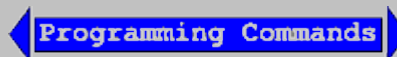

Error Display dialog box help

On Preset, these settings revert to their defaults (enabled).

Enable Messages Check to display all VNA error messages as they occur. Clear to suppress the display of VNA error messages. You can still view them in the [error log](#).

Calibration Error Message Windows

Status Bar Displays error messages on the status bar. You can then view the message in the [error log](#) and get further assistance.

Confirmation Dialog boxes Displays error messages in a standard dialog box. You then choose

OK or **Cancel** to close the dialog box, or press Help to get further information on the error message.

View Error Log

The VNA Error Log is a list of events that have occurred in exception to SCPI errors/Power On Test errors, etc. (Events are used in programming the VNA using COM.) VNA errors is a subset of VNA events. Only events with severity codes of ERROR are displayed on the VNA screen as they occur. From the error log, you can access further help with an error by selecting the error and clicking Help.

How to view the Error Log

Using **Hardkey/SoftTab/Softkey**

1. Press **Sweep** > **Help** > **View Error Log**.

No programming commands

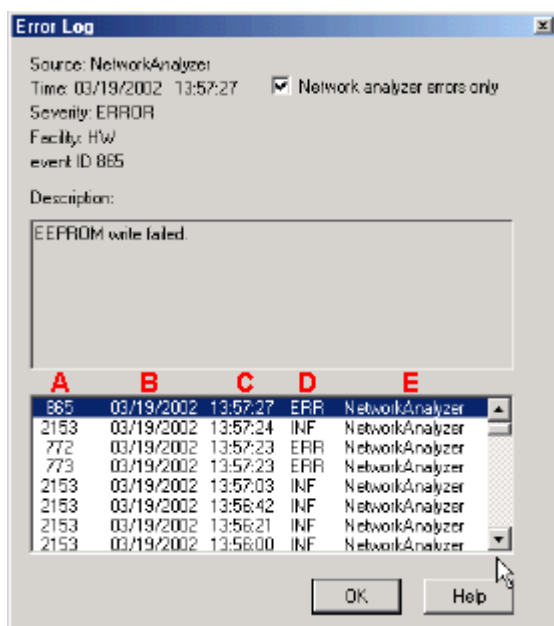

Error Log dialog box help

Network analyzer errors only Select to view only VNA errors. Clear to view all errors that occur on all applications of the computer.

Description Error message that appears on the VNA screen.

A - Event ID Error message number

B - Date the Error occurred

C - Time the Error occurred

D - Severity Code - All events have one of the following severity codes:

- SUCcess - the operation completed successfully
- INFormational - events that occur without impact on the measurement integrity

- WARning - events that occur with potential impact on measurement integrity
- ERRor - events that occur with serious impact on measurement integrity

E - Application in which the error occurred.

OK Closes the Dialog box

Help Provides further information on the selected Error message

To clear the Error Log:

1. From the **System** > **Main** menu click **Minimize Application**
2. On the desktop, select **Start** > **Control Panel**
3. On the Control Panel, click **Administrative Tools**
4. On the Administrative Tools window, click **Event Viewer**
5. On the Event Viewer window, right-click **Application**
6. Select **Clear Log**
7. If you want to save a file with the contents of the Event Log, click **Save and Clear**. Otherwise, click **Clear**

To restore the VNA application, click on the VNA Analyzer taskbar button at the bottom of the screen

Last Modified:

29-Sep-2015 First Release

Analyzer Accessories

- [Coax Mechanical Calibration Kits](#)
- [Waveguide Mechanical Calibration Kits](#)
- [Electronic Calibration \(ECal\)](#)
- [Mechanical Verification Kits](#)
- [Adapter and Accessory Kits](#)
- [Test Port Cables](#)
- [USB Peripherals](#)
- [Connector Care and ESD Supplies](#)

Other Support topics

For product and order information:

- Visit www.keysight.com/find/accessories
- Use the search function to locate information about a particular accessory or view the entire RF and Microwave Test Accessories Catalog.

Accessories are available in these connector types:

- 50 ohm Type-N
- 75 ohm Type-N
- 3.5 mm
- 7 mm (APC-7)
- 7-16
- 2.92 mm
- 2.4 mm
- 1.85 mm
- 1 mm

Test port cables and a calibration kit are necessary for a complete measurement system.

A verification kit is used to verify corrected system performance.

See the connector type for each VNA model

Coax Mechanical Calibration Kits

Model	Connector Type	Frequency Upper Limit
85032B	Type-N (50 Ohm)	6 GHz

85032F	Type-N (50 Ohm)	9 GHz
85054B	Type-N (50 Ohm)	18 GHz
85036E	Type-N (75 Ohm)	3 GHz
85050B	7 mm	18 GHz
85033D	3.5 mm	6 GHz
85038A	7-16	7.5 GHz
85033E	3.5 mm	9 GHz
85052B	3.5 mm	26.5 GHz
85052C	3.5 mm TRL	26.5 GHz
85056K	2.92 mm	50 GHz
85056A	2.4 mm	50 GHz
85058B/E (data-based)	1.85 mm	67 GHz
85059A (data-based)	1.00 mm	110 GHz

Waveguide Mechanical Calibration Kits

Model	Connector Type	Frequency Range
X11644A	WR-90	8.2-12.4 GHz
P11644A	WR-62	12.4-18 GHz
K11644A	WR-42	18-26.5 GHz
R11644A	WR-28	26.5-40 GHz
Q11644A	WR-22	33-50 GHz
U11644A	WR-19	40-60 GHz
V11644A	WR-15	50-75 GHz

Electronic Calibration (ECal)

Model	Connector Type	Frequency Range
RF Two-Port		
85091C	7 mm (APC-7)	300 kHz-9 GHz
85092C	Type-N (50 ohm) Port B available with 3.5 mm or 7-16 ^a	300 kHz-9 GHz
85093C	3.5 mm Port B available with Type-N (50 ohm) or 7-16 ^a	300 kHz-9 GHz
85096C	Type-N (75 ohm)	300 kHz-3 GHz
85098C	7-16 ^a Port B available with Type-N (50 ohm) or 3.5 mm	300 kHz-7.5 GHz
85099C	Type-F	300 kHz-3 GHz
RF Four-Port		
N4431B	3.5mm (f) (four-port), Type-N (f) (four-port), Mixed connector types	9 kHz ^b -13.5 GHz
N4432A Option 020	Type-N (f) (four-port)	300 kHz-18 GHz (available Feb. 2006)
N4432A Option 030	APC 7 (four-port)	300 kHz-18 GHz (available Feb. 2006)
N4433A Option 010	3.5mm (f) (four-port)	300 kHz-20 GHz (available Feb. 2006)
Microwave Two-Port		
N4690B	Type-N (50 ohm)	300 kHz-18 GHz
N4691B	3.5 mm	300 kHz-26.5 GHz
N4692A	2.92 mm	10 MHz-40 GHz
N4693A	2.4 mm	10 MHz-50 GHz
N4694A	1.85 mm	10 MHz-67 GHz
N4696BA	7 mm	300 kHz-18 GHz

^a Limits ECal module high frequency to 7.5 GHz.

^b Performance from 9 kHz to 300 kHz is valid only for the E5080A and E5071C ENA Network analyzer (firmware version A.09.10 or higher).

Verification Kits

Model	Connector Type	Frequency Range
85055A	Type-N (50 Ohm)	300 kHz-9 GHz
85053B	3.5 mm	300 kHz-26.5 GHz
85057B	2.4 mm	.045-50 GHz
R11645A	WR-28	26.5-40 GHz
Q11645A	WR-22	33-50 GHz

Adapters and Accessory Kits

Model	Description
11878A	Type-N to 3.5 mm Adapter Kit
11525A	Type-N (m) to 7 mm (APC-7)
11853A	Type-N Accessory Kit
11900B	2.4 mm (f) to 2.4 mm (f)
11900C	2.4 mm (f) to 2.4 mm (m)
85130G	Test Port Adapter Set, 2.4 mm (f) to 2.4 mm (m,f)
11901B	2.4 mm (f) to 3.5 mm (f)
11901D	2.4 mm (f) to 3.5 mm (m)
85130F	Test Port Adapter Set, 2.4 mm (f) to 3.5 mm (m,f)
11902B	2.4 mm (f) to 7 mm (APC-7)
11920A	1 mm (m) to 1 mm (m)
11920B	1 mm (f) to 1 mm (f)
11920C	1 mm (m) to 1 mm (f)
11921A	1 mm (m) to 1.85 mm (m)

11921B	1 mm (f) to 1.85 mm (f)
11921C	1 mm (m) to 1.85 mm (f)
11921D	1 mm (f) to 1.85 mm (m)
11922A	1 mm (m) to 2.4 mm (m)
11922B	1 mm (f) to 2.4 mm (f)
11922C	1 mm (m) to 2.4 mm (f)
11922D	1 mm (f) to 2.4 mm (m)

Test Port Cables

Model	Description
N4697E	1.85 mm (f) to 1.85 mm (rugged f) flexible (single)
N4697F	1.85 mm (rugged f, f) to 1.85 mm (rugged m, rugged f) flexible (set)
N6315A	Type-N (m) to Type-N (f), 16 in. (single)
N6314A	Type-N (m) to Type-N (m), 24 in. (single)
85133D	2.4 mm (f) to 2.4 mm (m,f) semi-rigid (set)
85133F	2.4 mm (f) to 2.4 mm (m,f) flexible (set)
85134D	2.4 mm (f) to 3.5 mm (m,f) semi-rigid (set)
85134F	2.4 mm (f) to 3.5 mm (m,f) flexible (set)

USB Peripherals

Model	Description
N4688A	CD RW drive - with USB cable.
N4689A	USB 4-port hub - for connecting additional USB peripherals.
82357B	USB/GPIB Interface - for controlling GPIB devices through USB. Learn more about using the 82357B with the VNA

Connector and ESD Supplies

[See ESD topic](#)

E5080A

[See more Connector Care supplies](#)

Part Number	Description
9300-1367	Adjustable antistatic wrist strap
9300-0980	Antistatic wrist strap grounding cord (5 foot)
9300-0797	Static control table mat (2 foot x 4 foot) with earth ground wire
9300-1126	ESD heel strap
1401-0248	ESD Safe End-Cap, Type-N (m)
1401-0247	ESD Safe End-Cap, Type-N (f)
1401-0214	Standard End-Cap, Type-N (m)
1401-0225	Standard End-Cap, Type-N (f)

Last Modified:

20-Nov-2014 First release

82357B USB / GPIB Interface

The Keysight 82357B is an adapter that creates a GPIB Interface from one of your unused VNA USB ports.

- [Applications](#)
- [Configuring](#)
- [Connecting](#)
- [Communicating with other Equipment](#)

Applications

The 82357B can be used to connect a GPIB device using the VNA USB for any VNA application. In addition, the 82357B can be used to connect a power meter for a source power calibration.

Configure the 82357B USB/GPIB Interface

When the 82357B is connected to the VNA USB, the following dialog box appears:

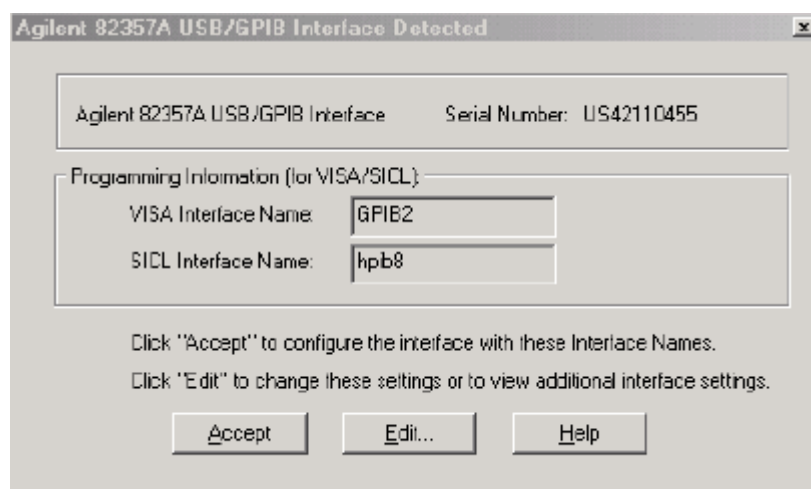

Normally, you do NOT need to edit these settings. The 82357B USB/GPIB Interface is configured automatically as the next unused VISA interface. This is usually **GPIB2** unless you have already configured it for another purpose.

If the VISA Interface Name appears as GPIB0 or GPIB1, these Interfaces must be returned to their default settings for the 82357B to work properly with the VNA. [See Configure for VISA / SICL to learn how.](#)

Connecting the 82357B USB/GPIB Interface

The following diagram illustrates how to connect GPIB test equipment using the USB/GPIB Interface.

- Plug the USB/GPIB Interface into any unused VNA USB port.
- The driver installation and connection is performed automatically.

Communicating with Equipment Connected to the USB/GPIB Interface

E5080A

- The Frequency Converter Application will automatically find and communicate with test equipment that is connected to the USB/GPIB Interface.
- Source power calibration: Select **GPIB** at the [Power Meter Settings dialog](#) and specify the GPIB address of the power meter.
- To control other devices through your own program using the 82357B , you must include the new GPIB Interface number when addressing the devices.

Last modified:

29-Sep-2015 First Release

Firmware Update

VNA firmware updates are available to you at no cost in a self-extracting Install Shield file. The update includes the VNA application, Online help, and Service Utilities..

To manually check the version of firmware on the VNA, click **System > Help > About NA....**

Tip: Use Move App to Back to cause the VNA application to move behind this application on the screen.

Note: After a firmware update...

- Custom Cal Kits must be imported. [Learn more](#)
- If a different desktop icon named "Network Analyzer" exists, the shortcut to the VNA application will assume the same icon. Right-click on the desktop, then click **Refresh**.

Other Support Topics

Updating Firmware

1. Download the latest firmware from <http://www.keysight.com/find/e5080a>.
2. Terminate the VNA application by pressing **System > Main > Exit**.
3. Transfer the file from your PC to your VNA using LAN or USB Pen drive.
4. Double-click the file on the VNA and follow the instruction.

Warning: You can save the update file to your PC, but do not attempt to install the VNA application on your PC. It will alter system settings and can result in system crashes.

Last Modified:

29-Sep-2015 First release

Option Enable

The Keysight License Manager allows you to manage and upgrade the options.

From windows menu, press All Programs > Keysight License Manager.

See the Keysight License Manager Help for more detail.



Instrument Calibration

An instrument calibration is a process where the VNA performance is measured to ensure that it operates within specifications. If any performance parameter does not conform to the published specifications, adjustments are made to bring the performance into conformance.

Why Should I Get an Instrument Calibrated?

Over time, the active components in the analyzer age and the performance may degrade or drift.

To ensure that the analyzer is performing to the published specifications, you should have an instrument calibration performed periodically.

How Often Should I Get an Instrument Calibrated?

It is your responsibility to determine the calibration period which best meets your requirements. However, a 12 to 18 month calibration cycle is appropriate for most users.

There are two things to consider: performance drift and connector wear.

- The instrument specifications are set to consider the performance drift that may occur over a 24 month period. Therefore, getting the instrument calibrated at 24 month intervals ensures that the analyzer maintains performance within the operating specifications. If you need the analyzer to maintain more consistent operation, you may want to have the instrument calibrated more often than the recommended 24-month interval.
- Connector wear is a bigger factor and depends on the number of connections that are made. The test ports become noticeably worn after 500 to 700 connections. This could represent about 12 months with average use. With more frequent connections, the calibration cycle should be sooner. You can extend the time between calibrations and thereby save money by using [connector savers](#) and by performing proper [Connector Care](#).

How Do I Get an Instrument Calibrated?

To get the instrument calibrated, send it to one of the Keysight Technologies service centers. See [Technical Support](#).

The VNA must be fully functional when it is sent to the service center, or they will charge for their repair services. If the VNA is being used in a secure environment where the hard drive can not be sent with the VNA, a second hard drive must be purchased and configured for use with the VNA in an "unclassified" environment before the VNA is sent to the service center.

To perform the instrument calibration yourself, you must have the following required items:

- Instrument Calibration Test Equipment
- Performance Test Software

What Are My Choices of Instrument Calibration?

The following types of instrument calibration are available from Keysight Technologies at the time of initial order:

Standard	Includes a certificate of calibration stating the instrument has been calibrated and is operating within the published specifications.
Option UK6	Available ONLY at the initial shipment. Includes the test data from the calibration and the certificate of calibration stating the instrument has been calibrated and is operating within the published specifications.
Option A6J	Available ONLY at the initial shipment. Includes the test data and measurement uncertainties from the calibration and the certificate of calibration stating the instrument has been calibrated using a process in compliance with ANSI Z540 and is operating within

the published specifications.

Option 1A7 Available ONLY at the initial shipment. Includes the test data and measurement uncertainties from the calibration and the certificate of calibration stating the instrument has been calibrated using a process in compliance with ISO 17025 and is operating within the published specifications.

The following types of instrument calibration are available from Keysight Technologies service center:

Keysight Calibration Includes the test data from the calibration and the certificate of calibration, stating the instrument has been calibrated and is operating within the published specifications.

ANSI Z540 Calibration Includes the test data from the calibration and the certificate of calibration, stating the instrument has been calibrated using a process in compliance with ANSI Z540.1 and is operating within the published specifications.

ISO 17025 Calibration Includes the test data from the calibration and the certificate of calibration, stating the instrument has been calibrated using a process in compliance with ISO 17025 and is operating within the published specifications.

For more information on these options, visit www.Keysight.com/find/calibration.

Last Modified:

24-Mar-2010 Updated options and cal cycle



Other Resources

The following network analysis resources are also available.

Document Resources

[Application Notes](#)

You can also access application notes at this URL:

<http://www.keysight.com/find/na>

Third-Party Resources

For information about test fixtures and part handlers, contact:

Inter-Continental Microwave

www.icmicrowave.com

For information about probing equipment and accessories, contact:

Cascade Microtech, Inc.

www.cascademicrotech.com

SCPI Errors

SCPI Errors

- [-100 to -200 Command Errors](#)
- [-200 to -299 Execution Errors](#)
- [-300 to -399 SCPI Specified Device-Specific Errors](#)
- [-400 to -800 Query and System Errors](#)
- [100 to 200 VNA-specific Errors](#)

See Also

[VNA Error messages.](#)

-100 to -200 Command Errors

A command error indicates that the test set's GPIB parser has detected an IEEE 488.2 syntax error. When one of these errors is generated, the command error bit in the event status register is set.

-100	std_command	Command - This event bit (Bit 5) indicates a syntax error, or a semantic error, or a GET command was entered, see IEEE 488.2, 11.5.1.1.4.
-101	std_invalidChar	Invalid character - Indicates a syntactic elements contains a character which is invalid for that type.
-102	std_syntax	Syntax - Indicates that an unrecognized command or data type was encountered. For example, a string was received when the device does not accept strings.
-103	std_invalidSeparator	Invalid separator - The parser was expecting a separator and encountered an illegal character. For example, the semicolon was omitted after a program message unit.
-104	std_wrongParamType	Data type -The parser recognized a data element different than one allowed. For example, numeric or string data was expected but block data was encountered.
-105	std_GETNotAllowed	GET not allowed - Indicates a Group Execute Trigger was received within a program message. Correct the program so that the GET does not occur within the program code.
-108	std_tooManyParameters	Parameter not allowed - Indicates that more parameters were received than expected for the header. For example, *ESE common command only accepts one parameter, so *ESE 0,1 is not allowed.
-109	std_tooFewParameters	Missing parameter - Indicates that less parameters were received than required for the header. For example, *ESE requires one parameter, *ESE is not allowed.
-110	std_cmdHeader	Command header - Indicates an error was detected in the header. This error is used when the device cannot detect the more specific errors -111 through -119.

-111	std_headerSeparator	Header separator - Indicates that a character that is not a legal header separator was encountered while parsing the header.
-112	std_IDTooLong	Program mnemonic too long - Indicates that the header contains more than twelve characters, see IEEE 488.2, 7.6.1.4.1.
-113	std_undefinedHeader	Undefined header - Indicates the header is syntactically correct, but it is undefined for this specific device. For example, *XYZ is not defined for any device.
-114	std_suffixOutOfRange	Header suffix out of range - Indicates the value of a header suffix attached to a program mnemonic makes the header invalid.
-120	std_numericData	Numeric data - This error, as well as errors
-121	std_invalidCharInNumber	Invalid character in number - Indicates an invalid character for the data type being parsed was encountered. For example, an alpha in a decimal numeric or a "9" in octal data.
-123	std_exponentTooLarge	Exponent too large - Indicates the magnitude of an exponent was greater than 32000, see IEEE 488.2, 7.7.2.4.1.
-124	std_decimalTooLong	Too many digits - Indicates the mantissa of a decimal numeric data element contained more than 255 digits excluding leading zeros, see IEEE 488.2, 7.7.2.4.1.
-128	std_numericNotAllowed	Numeric data not allowed - Indicates that a legal numeric data element was received, but the device does not accept one in this position for the header.
-130	std_suffix	Suffix - This error, as well as errors -131 through -139, are generated when parsing a suffix. This particular error message is used if the device cannot detect a more specific error.
-131	std_badSuffix	Invalid suffix - Indicates the suffix does not follow the syntax described in IEEE 488.2, 7.7.3.2, or the suffix is inappropriate for this device.
-134	std_suffixTooLong	Suffix too long - Indicates the suffix contain more than 12 characters, see IEEE 488.2, 7.7.3.4.
-138	std_suffixNotAllowed	Suffix not allowed - Indicates that a suffix was encountered after a numeric element that does not allow suffixes.
-140	std_charData	Character data - This error, as well as errors
-141	std_invalidCharData	Invalid character data - Indicates that the character data element contains an invalid character or the particular element received is not valid for the header.
-144	std_charDataTooLong	Character data too long - Indicates the character data element contains more than twelve characters, see IEEE 488.2, 7.7.1.4.
-148	std_charNotAllowed	Character data not allowed - Indicates a legal character data element was encountered where prohibited by the device.
-150	std_stringData	String data - This error, as well as errors

-151	std_stringInvalid	Invalid string data - Indicates that a string data element was expected, but was invalid, see IEEE 488.2, 7.7.5.2. For example, an END message was received before the terminal quote character.
-158	std_stringNotAllowed	String data not allowed - Indicates that a string data element was encountered but was not allowed by the device at this point in parsing.
-160	std_blockData	Block data - This error, as well as errors -161 through -169, are generated when parsing a block data element. This particular error message is used if the device cannot detect a more specific error.
-161	std_badBlock	Invalid block data - Indicates a block data element was expected, but was invalid, see IEEE 488.2, 7.7.6.2. For example, an END message was received before the end length was satisfied.
-168	std_blockNotAllowed	Block data not allowed - Indicates a legal block data element was encountered, but not allowed by the device at this point in parsing.
-170	std_expr	Expression - This error, as well as errors -171 through -179, are generated when parsing an expression data element. This particular error message is used if the device cannot detect a more specific error.
-171	std_invalidExpression	Invalid expression - Indicates the expression data element was invalid, see IEEE 488.2, 7.7.7.2. For example, unmatched parentheses or an illegal character.
-178	std_exprNotAllowed	Expression data not allowed - Indicates a legal expression data was encountered, but was not allowed by the device at this point in parsing.
-180	std_macro	Macro - This error, as well as error -181 through -189, are generated when defining a macro or execution a macro. This particular error message is used if the device cannot detect a more specific error.
-181	std_validOnlyInsideMacro	Invalid outside macro definition - Indicates that a macro parameter place holder was encountered outside of a macro definition.
-183	std_invalidWithinMacro	Invalid inside macro definition - Indicates that the program message unit sequence, sent with a *DDT or a *DMC command, is syntactically invalid, see IEEE 488.2, 10.7.6.3.
-184	std_macroParm	Macro parameter - Indicates that a command inside the macro definition had the wrong number or type of parameters.

-200 to -299 Execution Errors

These errors are generated when something occurs that is incorrect in the current state of the instrument. These errors may be generated by a user action from either the remote or the manual user interface

-200	std_execGen	Execution - This event bit (Bit 4) indicates a PROGRAM DATA element following a header was outside the legal input range or otherwise inconsistent with the device's capabilities, see IEEE 488.2, 11.5.1.1.5.
-201	std_invalidWhileInLocal	Invalid while in local
-202	std_settingsLost	Settings lost due to rtl
-203	std_commandProtected	Command protected - Indicates that a legal password-protected program command or query could not be executed because the command was

	disabled.
-210 std_trigger	Trigger
-211 std_triggerIgnored	Trigger ignored
-212 std_armIgnored	Arm ignored
-213 std_initIgnored	Init ignored
-214 std_triggerDeadlock	Trigger deadlock
-215 std_armDeadlock	Arm deadlock
-220 std_parm	Parameter - Indicates that a program data element related error occurred.
-221 std_settingsConflict	Settings conflict - Indicates that a legal program data element was parsed but could not be executed due to the current device state.
-222 std_dataOutOfRange	Data out of range - Indicates that a legal program data element was parsed but could not be executed because the interpreted value was outside the legal range defined by the devices
-223 std_tooMuchData	Too much data - Indicates that a legal program data element of block, expression, or string type was received that contained more data than the device could handle due to memory or related device-specific requirements.
-224 std_illegalParmValue	Illegal parameter value - Indicates that the value selected was not part of the list of values given.
-225 std_noMemoryForOp	Out of memory - The device has insufficient memory to perform the requested operation.
-226 std_listLength	Lists not same length - Attempted to use LIST structure having individual LIST's of unequal lengths.
-230 std_dataCorruptOrStale	Data corrupt or stale - Indicates invalid data, a new reading started but not completed since the last access.
-231 std_dataQuestionable	Data questionable - Indicates that measurement accuracy is suspect.
-232 std_invalidFormat	Invalid format
-233 std_invalidVersion	Invalid version - Indicates that a legal program data element was parsed but could not be executed because the version of the data is incorrect to the device. For example, a not supported file version, a not supported instrument version.
-240 std_hardware	Hardware - Indicates that a legal program command or query could not be executed because of a hardware problem in the device.
-241 std_hardwareMissing	Hardware missing - Indicates that a legal program command or query could not be executed because of missing device hardware. For example, an option was not installed.
-250 std_massStorage	Mass storage - Indicates that a mass storage error occurred. The device

- cannot detect the more specific errors described for errors -251 through -259.
- 251 std_missingMassStorage Missing mass storage - Indicates that a legal program command or query could not be executed because of missing mass storage.
 - 252 std_missingMedia Missing media - Indicates that a legal program command or query could not be executed because of missing media. For example, no disk.
 - 253 std_corruptMedia Corrupt media - Indicates that a legal program command or query could not be executed because of corrupt media. For example, bad disk or wrong format.
 - 254 std_mediaFull Media full- Indicates that a legal program command or query could not be executed because the media is full. For example, there is no room left on the disk.
 - 255 std_directoryFull Directory full - Indicates that a legal program command or query could not be executed because the media directory was full.
 - 256 std_fileNotFound File name not found - Indicates that a legal program command or query could not be executed because the file name was not found on the media.
 - 257 std_fileName File name - Indicates that a legal program command or query could not be executed because the file name on the device media was in error. For example, an attempt was made to read or copy a nonexistent file.
 - 258 std_mediaProtected Media protected - Indicates that a legal program command or query could not be executed because the media was protected. For example, the write-protect switch on a memory card was set.
 - 260 std_expression Expression
 - 261 std_math Math in expression
 - 270 std_macroExecution Macro - Indicates that a macro related execution error occurred.
 - 271 std_macroSyntax Macro syntax - Indicates that a syntactically legal macro program data sequence, according to IEEE 488.2, 10.7.2, could not be executed due to a syntax error within the macro definition.
 - 272 std_macroExec Macro execution - Indicates that a syntactically legal macro program data sequence could not be executed due to some error in the macro definition, see IEEE 488.2, 10.7.6.3.
 - 273 std_badMacroName Illegal macro label - Indicates that the macro label was not accepted, it did not agree with the definition in IEEE 488.2, 10.7.3
 - 274 std_macroPlaceholderMacro parameter - Indicates that the macro definition improperly used a macro parameter placeholder, see IEEE 488.2, 10.7.3.
 - 275 std_macroTooLong Macro definition too long - Indicates that a syntactically legal macro program data sequence could not be executed because the string of block contents were too long for the device to handle, IEEE 488.2, 10.7.6.1.
 - 276 std_macroRecursion Macro recursion - Indicates that a syntactically legal macro program data

		sequence count not be executed because it would be recursive, see IEEE 488.2, 10.7.6.6.
-277	std_cantRedefineMacro	Macro redefinition not allowed - Indicates that redefining an existing macro label, see IEEE 488.2, 10.7.6.4.
-278	std_macroNotFound	Macro header not found - Indicates that a legal macro label in the *GMS?, see IEEE 488.2, 10.13, could not be executed because the header was not previously defined.
-280	std_program	Program
-281	std_cantCreateProgram	Cannot create program
-282	std_illegalProgramName	Illegal program name
-283	std_illegalVarName	Illegal variable name
-284	std_programRunning	Program currently running
-285	std_programSyntax	Program syntax
-286	std_programRuntime	Program runtime
-290	std_memoryUse	Memory use
-291	std_execOutOfMemory	Out of memory
-292	std_nameNotFound	Referenced name does not exist
-293	std_nameAlreadyExists	Referenced name already exists
-294	std_incompatibleType	Incompatible type

-300 to -399 SCPI Specified Device-Specific Errors

A device-specific error indicates that the instrument has detected an error that occurred because some operations did not properly complete, possibly due to an abnormal hardware or firmware condition. For example, an attempt by the user to set an out of range value will generate a device specific error. When one of these errors is generated, the device specific error bit in the event status register is set.

-300	std_deviceSpecific	Device specific - This event bit (Bit 3) indicates that a device operation did not properly complete due to some condition, such as overrange see IEEE 488.2, 11.5.1.1.6.
-310	std_system	System
-311	std_memory	Memory - Indicates some physical fault in the devices memory, such as a parity error.
-312	std_PUDmemoryLost	PUD memory lost - Indicates protected user data saved by the *PUD command has been lost, see IEEE 488.2, 10.27.
-313	std_calMemoryLost	Calibration memory lost - Indicates that nonvolatile calibration data used by the *CAL? command has been lost, see IEEE 488.2, 10.2.
-314	std_savRclMemoryLost	Save/recall memory lost - Indicates that the nonvolatile data saved by the *SAV command has been lost, see IEEE 488.2, 10.33.

-315	std_configMemoryLost	Configuration memory lost - Indicates that nonvolatile configuration data saved by the device has been lost.
-320	std_storageFault	Storage fault - Indicates that the firmware detected a fault when using data storage. This is not an indication of physical damage or failure of any mass storage element.
-321	std_outOfMemory	Out of memory - An internal operation needed more memory than was available
-330	std_selfTestFailed	Self-test failed - Indicates a problem with the device that is not covered by a specific error message. The device may require service.
-340	std_calFailed	Calibration failed - Indicates a problem during calibration of the device that is not covered by a specific error.
-350	std_queueOverflow	Queue overflow - Indicates that there is no room in the queue and an error occurred but was not recorded. This code is entered into the queue in lieu of the code that caused the error.
-360	std_comm	Communication - This is the generic communication error for devices that cannot detect the more specific errors described for error -361 through -363.
-361	std_parity	Parity in program message - Parity bit not correct when data received for example, on a serial port.
-362	std_framing	Framing in program message - A stop bit was not detected when data was received for example, on a serial port (for example, a baud rate mismatch).
-363	std_inputBufferOverrun	Input buffer overrun - Software or hardware input buffer on serial port overflows with data caused by improper or nonexistent pacing.

-400 to -800 Query and System Errors

A Query error is generated either when data in the instrument's GPIB output queue has been lost, or when an attempt is being made to read data from the output queue when no output is present or pending.

-400	std_queryGen	Query - This event bit (Bit 2) indicates that an attempt to read data from the Output Queues when no output is present or pending, to data in the Output Queue has been lost see IEEE488.2, 11.5.1.1.7.
-410	std_interrupted	Query INTERRUPTED - Indicates the test set has been interrupted by a new program message before it finishes sending a RESPONSE MESSAGE see IEEE 488.2, 6.3.2.3.
-420	std_terminated	Query UNTERMINATED - Indicates an incomplete Query in the program see IEEE 488.2, 6.3.2.2.
-430	std_deadlocked	Query DEADLOCKED - Indicates that the Input Buffer and Output Queue are full see IEEE 488.2, 6.3.1.7.
-440	std_responseNotAllowed	Query UNTERMINATED after indefinite response - Indicates that a query was received in the same program message after a query requesting an indefinite response was executed see IEEE 488.2, 6.5.7.5.

-500	std_powerOn	Power on
-600	std_userRequest	User request
-700	std_requestControl	Request control
-800	std_operationComplete	Operation complete

.

VNA Specific (Positive) SCPI Errors

100	dupWindNum	"Duplicate window number"
101	windNumNotFound	"Window number not found"
102	failedWindCreate	"Window creation failed"
103	noCalcParamSelection	"CALC measurement selection set to none"
104	dupMeasName	"Duplicate measurement name"
105	dataNotFound	"Requested data not available"
106	measNotFound	"Requested measurement not found"
107	traceNotFound	"Requested trace not found"
108	notImplemented	"Mnemonic not yet implemented"
109	noDocument	"No measurement container found"
110	dupTraceNum	"Duplicate trace number"
111	titleStrTooLong	"Title string exceeds 50 characters"
112	memoryNotFound	"Requested memory not found"
113	exceedMaxTraces	"Exceeded the maximum number of traces per window"
114	SerNumNotFound	"The serial number was not found. Please store the serial number."
115	LoadFailed	"The state was not loaded. Please check the file name."
116	StoreFailed	"The state was not stored. Please check the file and path names."
117	File	"An in the File operation occurred. Please check file and path names."
118	measChanConflict	"Measurement does not belong to specified channel."
119	exceedMaxWindows	"Exceeded the maximum number of data windows"
120	markerNotFound	"The specified marker was not found."
121	diagnostic	"Diagnostic ."
122	channelNotFound	"The specified channel was not found."

123	exceedMaxMeasurements	"Exceeded the maximum number of allowed measurements."
124	parameterOutOfRange	"The specified value was out of range."
125	userRangeNotValid	"The currently selected user range is not valid."
126	referenceMarkerNotFound	"The reference marker is not active."
127	sweepSegmentNotFound	"The sweep segment was not found."
128	markerNotDelta	"The specified marker is not a delta marker."
129	printoutFailed	"Attempt to output to a printer failed."
130	memory_trace_not_compatible	"Memory not compatible. Trace Math not applied."
131	trace_math_reset	"Memory not compatible. Trace Math turned off."
132	hw_read_failed	"Hardware read failed."
133	hw_write_failed	"Hardware write failed."
134	dsp_active	"Failed because DSP was not halted."
135	secure_memory	"Attempt to access secure memory region."
136	snum_protected	"The serial number is protected."
137	snum_format_bad	"The serial number format is bad."
138	snum_already_set	"The serial number is already set."
139	hw_setting_failed	"Hardware setting failed."
140	cal_access_failed	"Calibration data access failed."
141	db_access_failed	"Database access failed."
142	memory_range_exceeded	"Command exceeds usable memory range."
143	lost_phase_lock	"Phase lock has been lost."
144	over_power	"Detected too much power at input."
145	ee_wrt_failed	"EEPROM write failed."
146	yig_cal_failed	"YTO calibration failed."
147	ramp_cal_failed	"Analog ramp calibration failed."
148	dspcom_bad	"DSP communication failed."
149	no_license_found	"Request failed. The required license was not found."
150	argLimited	"The argument was out of range"
151	markerBWNotFound	"The Marker Bandwidth was not found."
153	peakNotFound	"The Peak was not found."

154	targetNotFound	"The Target search value was not found."
155	calNotImpl	"The Calibration feature requested is not implemented."
156	calClassNotValidForCalType	"SENS:CORR:CCH measurement selection set to none"
158	calNotValidForConfidenceChe	"Selected measurement does not have a calibration valid for Confidence Check"
159	invalidPort	"Specified port is out of range"
160	invalidPortPath	"ROUT:PATH:DEF:PORT x, y does not match measurement; setting to defaults"
161	ioInvalidWrite	"Attempted I/O write while port set to read only."
162	ioInvalidRead	"Attempted I/O read from write only port."
163	calsetNotFound	"Requested Cal Set was not found in Cal Set Storage."
164	noCalSetSelected	"There is no Cal Set currently selected for the specified channel."
165	cantDeleteCalSetInUse	"Cannot delete a Cal Set while it is being used."
166	calsetStimChange	"Channel stimulus settings changed to match selected Cal Set."
167	exceedMaxCalSets	"Exceeded the maximum number of cal sets."
168	calCouldNotTurnOn	"A valid calibration is required before correction can be turned on."
169	standardMeasurementRequired	"The attempted operation can only be performed on a standard measurement type."
170	noDivisorBuffer	"A valid divisor buffer is required before normalization can be turned on."
171	InvalidReceiverPowerCalParagraph	"Receiver power cal requires the measurement to be of unratiod power."
172	ecalCouldNotConfigure	"Could not configure the Electronic Calibration system. Check to see if the module is plugged into the proper connector."
173	measHasNoMemoryAlg	"This measurement does not support memory operations"
174	measHasNoNormalizeAlg	"This measurement does not support normalize operations."
175	userCharacterizationNotFound	"User characterization was not found in the Electronic Calibration module."
176	measInvalidBufferSize	"The data provided has an invalid number of points. It could not be stored."



E5080A

Technical Support

For contact information, visit <http://www.keysight.com/find/contactus>

Diagnostic Tools and Adjustments

Display Test

The VNA screen should be bright with all annotations and text readable. The display test allows you to check for non-functioning pixels and other problems.

What Is a Damaged Pixel?

A pixel is a picture element that combines to create the image on the display. They are about the size of a small pin point. Damaged pixels can be either “stuck on” or “dark.”

- Stuck on pixel - red, green, or blue; always displayed regardless of the display setting. It will be visible on a dark background.
- Dark pixel - always dark; displayed against a background of its own color.

How to Run the Display Test

Press **System** > **Service** > **Display Test**

A multi-color screen is displayed. Be prepared to look for the symptoms described below. Click the **Start Test** button. To continue to the next test, click the moving Next Test button. The button moves to allow you to see all of the display. After the test is completed, the display defaults to the network analyzer screen.

How to Identify a Faulty Display

Valid pixels are 99.998 % and more. Below 0.002 % of fixed points of black, blue, green or red are not regarded as failure.

If any of these symptoms occur, your display is considered faulty. See the Service Guide for your VNA model.

Operator's Check

- [Overview](#)

Overview

The Operator's Check should be performed when you first receive your VNA, and any time you wish to have confidence that the VNA is working properly.

Notes

- The Operator's Check does not verify performance to specifications. To verify VNA performance to specifications, run performance test or [System Verification](#).
- Allow the VNA to warm up for 90 minutes before considering a failed test to be valid.

How to Run the Operator's Check

Using **Hardkey/SoftTab/Softkey**

1. Press **System > Service > Operator's Check**

1. Follow the instruction to proceed the test.

See Trouble shooting guide for detail

Last Modified:

29-Sep-2015 First Release

System Verification

The performance of the network analyzer is specified in two ways: system specifications, and instrument specifications. It is the end user's responsibility to determine which set of specifications is applicable to their use of the VNA.

A network analyzer measurement "system" includes the analyzer, calibration kit, test cables, and any necessary adapters. The system verification software in the VNA is used to verify the system's conformance to the "system" specifications. A "pass" result demonstrates that the analyzer, test cables, and adapters, perform correctly as a system. It DOES NOT demonstrate that any one component performs according to its individual specifications. A change to any part of this measurement system requires a re-verification of the system.

Instrument specifications specify the network analyzer's uncorrected measurement port characteristics and its output and input behavior. The VNA performance tests are used to verify the analyzer's conformance to "instrument" specifications.

The system verification utility verifies the VNA system specifications by automatically measuring the magnitude and phase for all four S-parameters for each verification device, and comparing the values against the following:

- Factory measured data from files on the verification media.
- Limit lines based on the measurement uncertainty

System Verification requires the use of a calibration kit and verification kit which has been certified within the past 12 months by Keysight. System Verification can NOT be used to perform this kit certification.

[Operator's Check](#) should also be performed to verify the basic operation of the VNA.

- [Equipment Used in the System Verification](#)
- [Precautions for Handling Airlines](#)
- [Flow Diagram of Procedure](#)
- [Procedure for System Verification](#)
- [If the System Fails the Verification Test](#)
- [Interpreting the Verification Results](#)

Notes

- Although the performance for all S-parameters is measured, the S-parameter phase uncertainties are less important for verifying system performance. Therefore, the limit lines will not appear on the printouts.
- System Verification can NOT be run with a Multiport test set enabled.

Equipment Used in the System Verification

Supported Verification Kit:

- 85053B, 3.5 mm, 300 kHz - 26.5 GHz
- 85055A, Type-N, 300 kHz - 18.0 GHz
- 85051B, 7 mm, 300 kHz - 18 GHz

The combination of Calibration Kit and Verification Kit

The combination of Calibration Kit and Verification Kit that can be used is as follows:

Cal kit	Connector	Kit Type	Verification Kit	Minimum Frequency	Maximum Frequency
85033D	3.5 mm	Mechanical	85053B or Anritsu 3666	-	6 GHz
85033E	3.5 mm	Mechanical	85053B or Anritsu 3666	-	9 GHz
85052D	3.5 mm	Mechanical	85053B or Anritsu 3666	-	26.5 GHz
85052C	3.5 mm	Mechanical	85053B or Anritsu 3666	-	26.5 GHz
85093B	3.5 mm	ECal**	85053B or Anritsu 3666	300 kHz	9 GHz
85093C	3.5 mm	ECal**	85053B or Anritsu 3666	300 kHz	9 GHz
N4433A	3.5 mm	ECal**	85053B or Anritsu 3666	300 kHz	20 GHz
N4691A	3.5 mm	ECal**	85053B or Anritsu 3666	10 MHz	26.5 GHz
N4691B	3.5 mm	ECal**	85053B or Anritsu 3666	300 kHz	26.6 GHz
85032B/E	Type-N	Mechanical	85055A	-	6 GHz
85032F	Type-N	Mechanical	85055A	-	9 GHz
85054D	Type-N	Mechanical	85055A	-	18 GHz
85092B	Type-N	ECal**	85055A	300 kHz	9 GHz
85092C	Type-N	ECal**	85055A	300 kHz	9 GHz
N4432A	Type-N	ECal**	85055A	300 kHz	18 GHz
N4690A	Type-N	ECal**	85055A	10 MHz	18 GHz
N4690B	Type-N	ECal**	85055A	300 kHz	18 GHz
85031B	APC-7mm	Mechanical	85051B or Anritsu 3667	-	6 GHz
85050C	APC-7mm	Mechanical	85051B or Anritsu 3667	-	18 GHz

85050D	APC-7mm	Mechanical	85051B or Anritsu 3667	-	18 GHz
85091B	APC-7mm	ECal**	85051B or Anritsu 3667	300 kHz	9 GHz
85091C	APC-7mm	ECal**	85051B or Anritsu 3667	300 kHz	9 GHz
N4696A	APC-7mm	ECal**	85051B or Anritsu 3667	10 MHz	18 GHz
N4696B	APC-7mm	ECal**	85051B or Anritsu 3667	300 kHz	18 GHz
N4431A*	3.5 mm	ECal**	85053B	300 kHz	9 GHz
N4431B*	3.5 mm	ECal**	85053B	9 kHz	13.5 GHz
N4431A*	Type-N	ECal**	85055A	300 kHz	9 GHz
N4431B*	Type-N	ECal**	85055A	9 kHz	13.5 GHz

* The connection of the N4431x is for the thru path A-B, C-D, A-D, and B-C.

** The supported connector type is "male-female" (insertable type). For non-insertable Ecal module, the calibration file (*.csa or *.cst) can be loaded from explorer at 1&2 or 3&4 port set.

Cable Substitution

The test port cables specified for the VNA have been characterized for connector repeatability, magnitude and phase stability with flexing, return loss, insertion loss, and aging rate. Since test port cable performance is a significant contributor to the system performance, cables of lower performance will increase the uncertainty of your measurement. It is highly recommended that the test port cables be regularly tested.

If the system verification is performed with a non-Keysight cable, ensure that the cable meets or exceeds the operation of the specified cable. Refer to the cable User's Guide for specifications.

Cable Flex Factor

Flex Factor determines how much of the cable phase uncertainty to include in determining the limit lines.

- Set to **0% (zero)** if the cables are held down in a fixture and are not allowed to move during the calibration and verification.
- Set to **100%** if the cables are allowed to move a lot.

Calibration Kit Substitution

Non-Keysight calibration kits are not recommended nor supported.

Precautions for Handling Airlines

When you are using the airlines in the verification kit, observe the following practices to ensure good measurement techniques.

- Be very careful not to drop the airline's center or outer conductor. Damage will result if these devices are dropped.

- Use proper Electro-Static Discharge (ESD) procedures.
- Clean your hands or wear gloves as skin oils will cause a change in electrical performance.

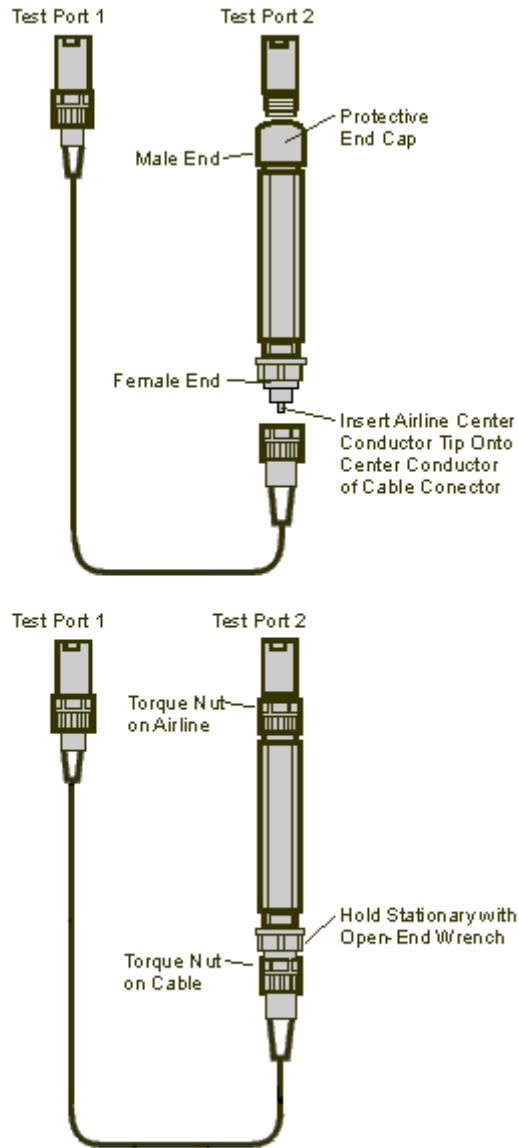

Flow Diagram of Procedure

The operational flow of the software is depicted by the flowchart shown below.

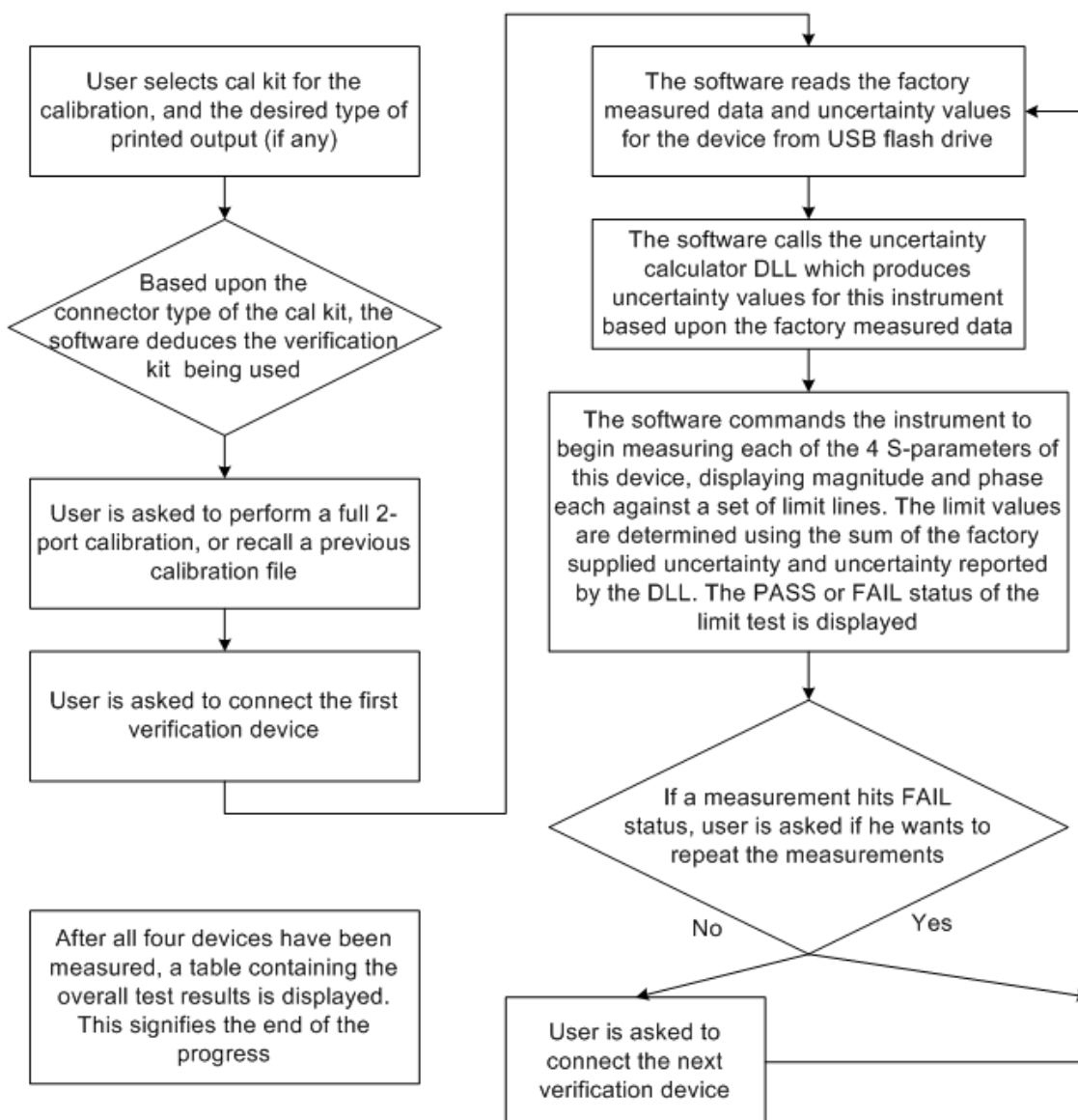

Procedure for System Verification

1. If you want printed test outputs, connect a printer to the analyzer. Let the analyzer warm up for at least 90 minutes.
2. Insert the VNA verification kit flash drive into the VNA USB port.
3. Click **System** > **Service** > **System Verification**. The System Verification window similar to this will be displayed.

System Verification Dialog

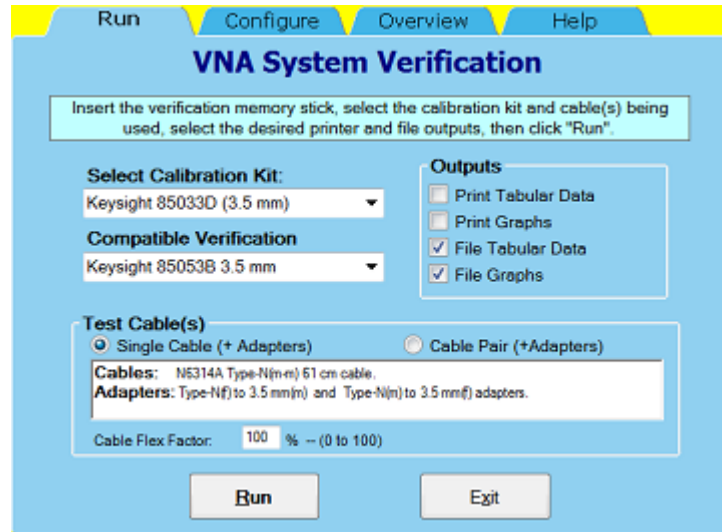

4. In the **Calibration Kit** box, select the calibration kit or ECal module that is being used. The corresponding verification kit to use appears in the **Verification Kit** box.
5. Under **Printer Output** click on any of the following options.
 - **Print Tabular Data:** Prints the verification data in tabular form which includes measured data and uncertainty limits. Refer to a tabular data example, later in this topic.
 - **Print Graphs:** Prints the verification data in graphical form. The graphic form includes the measured data trace, factory supplied data trace and uncertainty limits. Refer to a plot data example, later in this topic.
 - **File Tabular Data:** Writes the verification data in tabular form to a text file in the c:\users\public\network analyzer\documents directory.
 - **File Graphs:** Saves a screen image in .PNG format in the c:\users\public\network analyzer\documents directory.

Note: If you want printed output, it is assumed you have already installed the Windows driver for your particular printer, and have tested that you can print to the printer from the network analyzer. This software is designed to print to whichever printer is currently set as the Default printer (see Printers in the Windows Control Panel).

6. To modify the number of ports to be verified, to change the number of devices to measure, or to use a previously stored verification calibration, click on the **Configure** tab and make the desired selections.
 - For the system verification to be truly adequate, the software must measure all devices in the kit with a recent calibration applied. Removing and reattaching any test port cables or adapters invalidates all previous calibrations.
7. Click **Run**.
8. Follow the instructions on the analyzer for performing the system verification, inserting the verification devices as prompted.

Note for 4 Port VNA:

The System Verification Procedure is **repeated two times**. The first time, **Ports 1 and 2** are measured as a pair, then **Ports 3 and 4** are measured.

Step-by-Step Process Description

1. Depending upon the selected choice in the Calibration submenu of the Configure menu, the user is either prompted to recall a previous calibrated instrument state, or is guided through a full 2-port calibration using the selected calibration kit. For ECal, the ECal module is connected just once; a standby message is posted while the software is performing the calibration.

2. The user is prompted to connect the first verification device.
3. The software reads the factory measured data for that device and uncertainty values for that data (CITIfiles) from the media supplied with the verification kit.
4. The software sends the factory measured data, calibration kit and instrument state information to the uncertainty calculator DLL, which generates uncertainty values specific to the VNA.
5. The analyzer first sets up for magnitude measurements of all four S-parameters, each parameter in a separate window (lin mag for S_{11} and S_{22} , log mag for S_{21} and S_{12}). Each of the factory measured S-parameters are fed to the appropriate window as a memory trace. Limit line offsets are calculated as the sum of the factory measured data uncertainties and VNA uncertainties reported by the DLL. Upper and lower limits are displayed (factory measured data + uncertainty sum, factory measured data - uncertainty sum). The VNA takes a sweep, limit test is turned on and PASS/FAIL status is reported in each of the four windows.
6. The user clicks a button when ready to view phase measurements. The four windows get updated for phase format, phase memory traces, phase limits and PASS/FAIL result.
7. If the limit test of any of the four S-parameters (magnitude or phase) indicates a FAIL status, the software suggests troubleshooting tips and asks if the user would like to repeat measurement of that device or proceed to the next device. If proceeding to the next device, the factory measured data and uncertainties for the next device are read from USB memory, the uncertainty DLL gets called with this next set of factory measured data, and the four measurement windows get updated for magnitude measurement of the next device.
8. The software follows this same process until all selected devices have been measured, at which point a summary window is displayed containing the set of PASS/FAIL results for all four parameters of each device.

If the System Fails the Verification Test

IMPORTANT: Inspect all connections. Do not remove the cable from the analyzer test port. This will invalidate the calibration that you have done earlier.

1. Repeat this verification test. Make good connections with correct torque specifications for each verification device.
2. Disconnect, clean and reconnect the device that failed the verification test. Then measure the device again.
3. If the analyzer still fails the test, check the measurement calibration.
4. Refer to the graphic below, for additional troubleshooting steps.

Verification Fails Flowchart

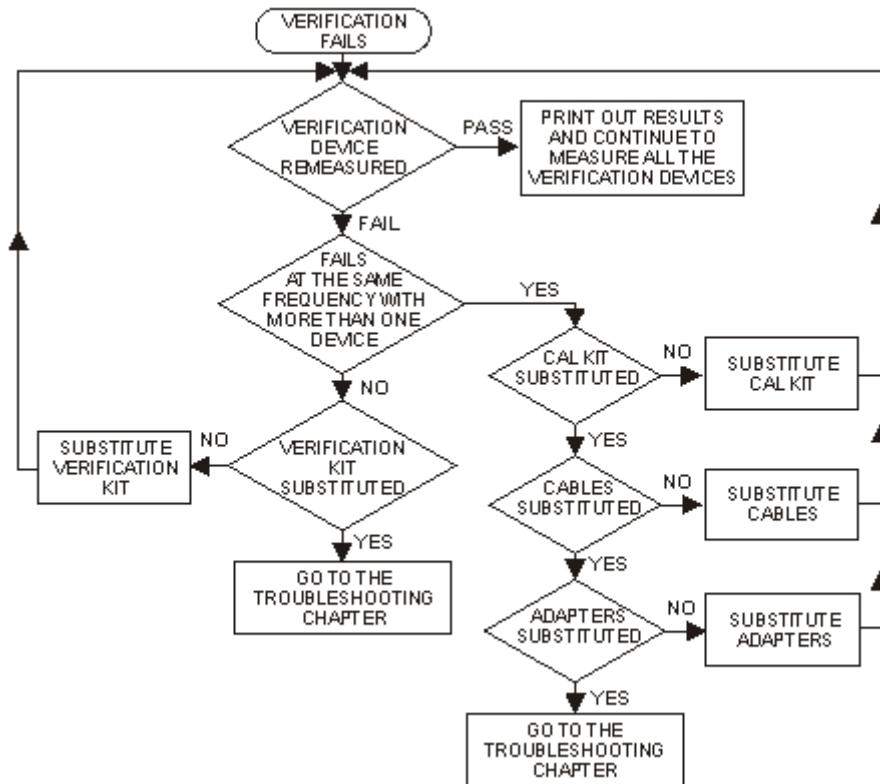

Interpreting the Verification Results

The graphic below shows an example of typical verification results with **Tabular Data** selected in the **Printer Output** area of the **System Verification** window. A graphic later in this topic shows an example of typical verification results with **Measurement Plots** selected in the **Printer Output** area of the **System Verification** windows. These printouts include a comparison of the data from your measurement results with the traceable data and corresponding uncertainty specifications. Use these printouts to determine whether your measured data falls within the total uncertainty limits at all frequencies.

The tabular data consists of:

- Frequency of the data points (in MHz).
- Lower limit line as defined by the total system uncertainty specification.
- Results of the measurement.
- Upper limit line as defined by the total system uncertainty specification.
- Test status (PASS or FAIL) of that measurement point.

Printout of Tabular Verification Results

The image shows a printed graphical verification results report. It contains two tables of data. The first table is titled 'All Results' and the second is titled 'All Results (Data With Limit) (100 MHz to 1000 MHz) (Mag) (dB)'. Both tables have columns for 'Freq', 'Upper', 'Lower', 'Mag', and 'Limit'. The data points are listed in a grid format, showing various frequency values and their corresponding upper and lower limits and measured values.

The printed graphical results show:

- Upper limit points as defined by the total system uncertainty specifications.
- Lower limit points as defined by the total system uncertainty specifications.
- Data measured at the factory.
- Results of measurements.
- Measurement parameter names and formats (Lin Mag or Log Mag).
- Serial number of device (00810).
- Device being measured (Sys Ver 20 dB attenuator).

Printout of Graphical Verification Results

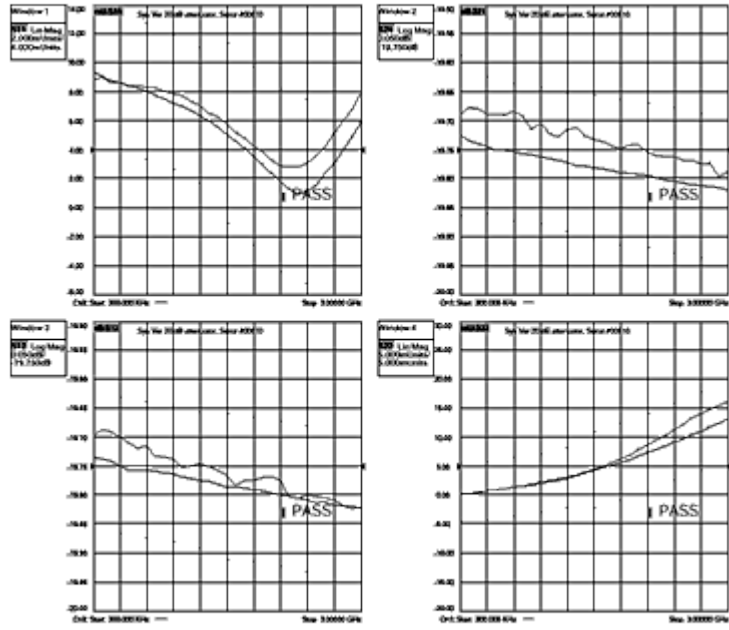

System Settings

Configure External Devices



Configure an External Device

Once configured (as shown in this topic), an external device will appear in, and be controlled from, relevant VNA dialogs as though it were internal to the VNA.

- [External Device Configuration Dialog Box](#)

The following (separate) topics discuss how to set properties for these types of devices:

- [External Source Properties](#)
 - [Power Meter As Receiver \(PMAR\) Properties](#)
-

External Device Configuration Dialog Box

How to access the External Device Configuration dialog box

VNA Applications have additional methods of launching this dialog.

Using **Hardkey/SoftTab/Softkey**

1. Press **Setup** > **External Hardware** > **External Device...**

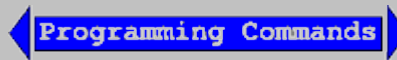

See Remotely Specifying a Source Port

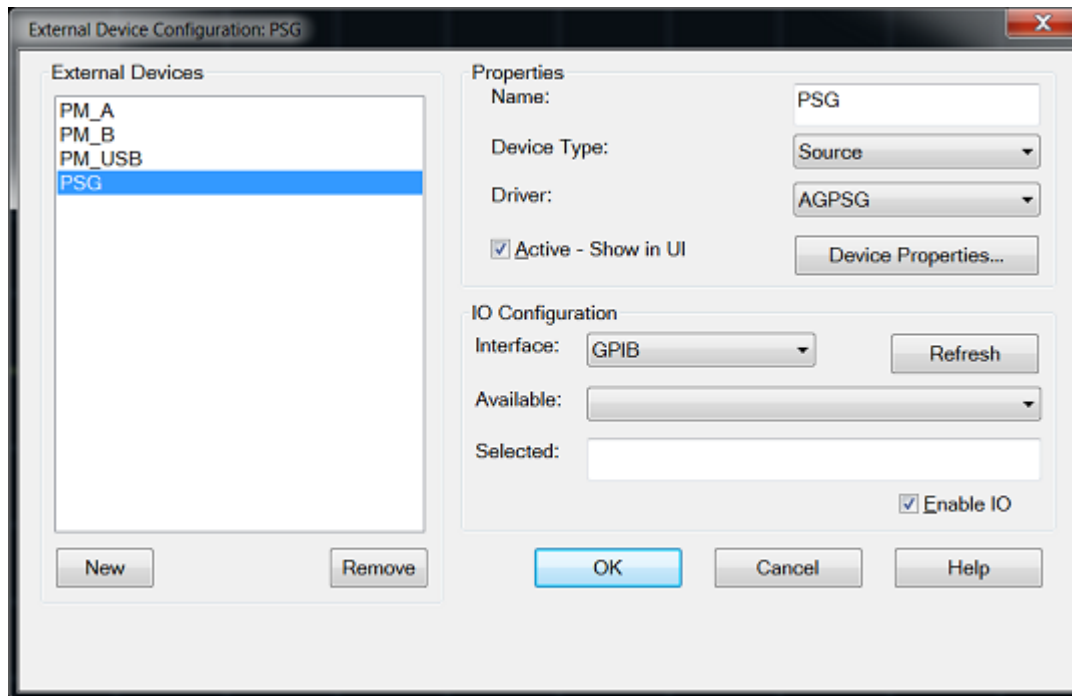

External Device Configuration Dialog Box Help

Important Notes:

- This dialog is used to configure the following types of external devices:
 - [External Source Properties](#) (Requires FOM option)
 - [Power Meter As Receiver \(PMAR\) Properties](#)
- To configure an external source using this dialog, VNA must have FOM option. Without this option, you must control an external source manually. See Synchronize an External Source for help with manual source control.
- By default, an external device is **de-activated** when the VNA is preset or when a Instrument State is recalled. This behavior can be changed with a Preference setting, so that it remains active through a Preset or Instrument State recall.
- External Device properties are NOT saved in an Instrument State file. However, the reference to the External Device from relevant VNA dialogs is saved. Therefore, recalling a state file that refers to a device that is NOT present will result in a "Device configuration not found" error.
- Multiple configurations for the same physical device can be Active. However, only one configuration for the same external source can have the [I/O Enabled](#).

External Devices

The devices that are currently configured appear in this list. The number of devices that can be configured is limited by the specified Interface.

New - Click to create a new device configuration. The default name is Device<n>, where <n> is the next number for 'Device'.

Remove - Click to remove the selected device from the list.

Properties

Name - Enter a device name as it will appear when referring to this device in VNA dialog boxes. Edit

the name at any time. However, duplicate names are not allowed.

- Because External Devices can be used with FOM ranges, do NOT name an external device any of the following FOM range names: "primary", "receivers", or "source", "source1", "source2" and so forth. Learn more about FOM ranges.
- Do NOT use a parameter name such as "S11" or "R1".

Device Type - Select one of the following:

- Power Meter (PMAR) - [Learn more](#)
- Source (RF) - [Learn more](#)
- **None** - returned remotely before setting Device Type.

Driver - Select the appropriate model to be configured.

(AG is short for Keysight).

For **Power Meter** device type, the driver is automatically choose **AGPM**.

For **Source** device type, choose the driver from the following list:

- **AG836XX** (8360 and 8340)
- **AGESG** (ESG)
- **AGEXG** (EXG) [See configuration note.](#)
- **AGGeneric** - For sources that are NOT listed but can be controlled using SCPI. Click Device Properties, then Edit Commands to send commands to these sources. [Learn how.](#)
- **AGMXG** (MXG) - The MXG must have at least firmware A.01.44 for FOM power sweep to work correctly.
- **AGPSG** (PSG)
- **HP834XX**

Note: Any device types have only ONE driver.

Active - Show in UI - Check to make the device available for use in the relevant dialogs. An instrument state that is saved with an Active device (checked) will include the device in the state file. Otherwise, if the Active box is cleared, the device will NOT appear in the state file. [Learn more about Instrument State files.](#)

Device Properties - Click to launch the Properties dialog for relevant Device type:

- [Configure External Sources](#)
- [Configure a Power Meter As Receiver](#)

IO Configuration

Interface - Select the interface that is used to connect the device to the VNA. These devices will then appear in the 'Available' field. Choose from:

- **GPIB** - Devices connected to the System Controller GPIB port.
- **USB** - Devices connected to the VNA USB ports. See Important First-time USB connection note.
- **Aliases** - Devices that are connected to ANY interface for which you created an alias. [See Configure Alias and LAN devices.](#)
- **LAN** - Devices connected to a network using a LAN connection. The VNA must also be connected to the network.

Note: Devices connected to LAN must first be configured in Keysight IO libraries before they will

appear on the Available list. [See Configure Alias and LAN devices.](#)

Available - Shows a list of devices that are connected to the specified IO Interface.

Refresh - Click to rescan the specified interface for devices.

Selected - Enter the IO configuration or select from the available list of IO Interfaces found.

Enable I/O - Clear this box to disable communication with the selected device. Do this to configure a device that is not yet connected to the VNA.

- Communication with devices is attempted when **Enable I/O** is checked, **Active** is checked and **OK** is pressed.
- When communication is attempted, devices with **Enable I/O** checked are queried for selected limits, such as frequency, power, and number of points. If there are limit problems, the VNA sends an error and the affected channels are put into Hold. These limits are enforced by the dialog box in which they are set. Resolve the reported limit problem and then restore the triggering.
- If communication with a device is lost the affected channels are put into Hold.

Configure Alias and LAN Devices

Use this procedure to configure a device using a LAN interface. Also, use for ANY device for which you want to set an alias (easily-recognized) name. The alias name appears in the Available field when Aliases is selected as the Interface.

1. On the VNA, minimize the VNA application (**System** > **Main** > **Minimize Application**).
2. In the system tray (lower-right corner) right-click the IO icon and then click **Keysight Connection Expert**.

To Add a LAN Device:

1. In **Keysight Connection Expert**, click  **Add Instrument**.
2. Select Add LAN Instrument (TCPIP0) or USB0, then click **OK**.
3. Click **Add Address** and then enter the IP address of the external source.
4. Click **Test Connection** to verify communication.
5. Click **OK**.

To create an Alias for a connected device:

1. In the list of connected instruments, right click the external source, then **Add VISA Alias**.
2. Enter the same Device name that was, or will be, used in the [External Device Configuration](#) dialog.

Last Modified:

29-Sep-2015 First Release



Configure an External Device

Once configured (as shown in this topic), an external device will appear in, and be controlled from, relevant VNA dialogs as though it were internal to the VNA.

- [External Device Configuration Dialog Box](#)

The following (separate) topics discuss how to set properties for these types of devices:

- [External Source Properties](#)
- [Power Meter As Receiver \(PMAR\) Properties](#)

External Device Configuration Dialog Box

How to access the External Device Configuration dialog box

VNA Applications have additional methods of launching this dialog.

Using **Hardkey/SoftTab/Softkey**

1. Press **Setup** > **External Hardware** > **External Device...**

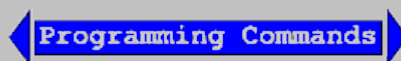

See Remotely Specifying a Source Port

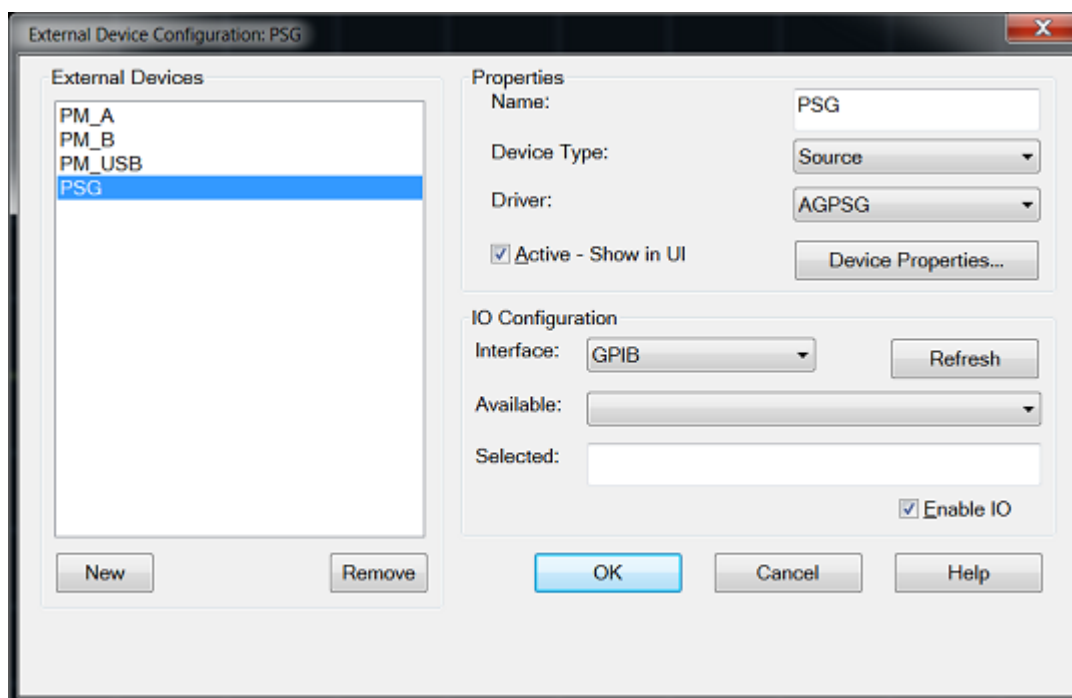

External Device Configuration Dialog Box Help

Important Notes:

- This dialog is used to configure the following types of external devices:
 - [External Source Properties](#) (Requires FOM option)
 - [Power Meter As Receiver \(PMAR\) Properties](#)
- To configure an external source using this dialog, VNA must have FOM option. Without this option, you must control an external source manually. See Synchronize an External Source for help with manual source control.
- By default, an external device is **de-activated** when the VNA is preset or when a Instrument State is recalled. This behavior can be changed with a Preference setting, so that it remains active through a Preset or Instrument State recall.
- External Device properties are NOT saved in an Instrument State file. However, the reference to the External Device from relevant VNA dialogs is saved. Therefore, recalling a state file that refers to a device that is NOT present will result in a "Device configuration not found" error.
- Multiple configurations for the same physical device can be Active. However, only one configuration for the same external source can have the [I/O Enabled](#).

External Devices

The devices that are currently configured appear in this list. The number of devices that can be configured is limited by the specified Interface.

New - Click to create a new device configuration. The default name is Device<n>, where <n> is the next number for 'Device'.

Remove - Click to remove the selected device from the list.

Properties

Name - Enter a device name as it will appear when referring to this device in VNA dialog boxes. Edit the name at any time. However, duplicate names are not allowed.

- Because External Devices can be used with FOM ranges, do NOT name an external device any of the following FOM range names: "primary", "receivers", or "source", "source1", source2" and so forth. Learn more about FOM ranges.
- Do NOT use a parameter name such as "S11" or "R1".

Device Type - Select one of the following:

- Power Meter (PMAR) - [Learn more](#)
- Source (RF) - [Learn more](#)
- **None** - returned remotely before setting Device Type.

Driver - Select the appropriate model to be configured.

(AG is short for Keysight).

For **Power Meter** device type, the driver is automatically choose **AGPM**.

For **Source** device type, choose the driver from the following list:

- **AG836XX** (8360 and 8340)
- **AGESG** (ESG)
- **AGEXG** (EXG) [See configuration note.](#)
- **AGGeneric** - For sources that are NOT listed but can be controlled using SCPI. Click Device

Properties, then Edit Commands to send commands to these sources. [Learn how.](#)

- **AGMXG** (MXG) - The MXG must have at least firmware A.01.44 for FOM power sweep to work correctly.
- **AGPSG** (PSG)
- **HP834XX**

Note: Any device types have only ONE driver.

Active - Show in UI - Check to make the device available for use in the relevant dialogs. An instrument state that is saved with an Active device (checked) will include the device in the state file. Otherwise, if the Active box is cleared, the device will NOT appear in the state file. [Learn more about Instrument State files.](#)

Device Properties - Click to launch the Properties dialog for relevant Device type:

- [Configure External Sources](#)
- [Configure a Power Meter As Receiver](#)

IO Configuration

Interface - Select the interface that is used to connect the device to the VNA. These devices will then appear in the 'Available' field. Choose from:

- **GPIB** - Devices connected to the System Controller GPIB port.
- **USB** - Devices connected to the VNA USB ports. See Important First-time USB connection note.
- **Aliases** - Devices that are connected to ANY interface for which you created an alias. [See Configure Alias and LAN devices.](#)
- **LAN** - Devices connected to a network using a LAN connection. The VNA must also be connected to the network.

Note: Devices connected to LAN must first be configured in Keysight IO libraries before they will appear on the Available list. [See Configure Alias and LAN devices.](#)

Available - Shows a list of devices that are connected to the specified IO Interface.

Refresh - Click to rescan the specified interface for devices.

Selected - Enter the IO configuration or select from the available list of IO Interfaces found.

Enable I/O - Clear this box to disable communication with the selected device. Do this to configure a device that is not yet connected to the VNA.

- Communication with devices is attempted when **Enable I/O** is checked, **Active** is checked and **OK** is pressed.
- When communication is attempted, devices with **Enable I/O** checked are queried for selected limits, such as frequency, power, and number of points. If there are limit problems, the VNA sends an error and the affected channels are put into Hold. These limits are enforced by the dialog box in which they are set. Resolve the reported limit problem and then restore the triggering.
- If communication with a device is lost the affected channels are put into Hold.

Configure Alias and LAN Devices

Use this procedure to configure a device using a LAN interface. Also, use for ANY device for which you want to set an alias (easily-recognized) name. The alias name appears in the Available field when Aliases is selected as the Interface.

1. On the VNA, minimize the VNA application (**System** > **Main** > **Minimize Application**).
2. In the system tray (lower-right corner) right-click the IO icon and then click **Keysight Connection Expert**.

To Add a LAN Device:

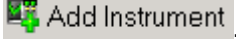
1. In **Keysight Connection Expert**, click  **Add Instrument**.
2. Select Add LAN Instrument (TCPIP0) or USB0, then click **OK**.
3. Click **Add Address** and then enter the IP address of the external source.
4. Click **Test Connection** to verify communication.
5. Click **OK**.

To create an Alias for a connected device:

1. In the list of connected instruments, right click the external source, then **Add VISA Alias**.
2. Enter the same Device name that was, or will be, used in the [External Device Configuration](#) dialog.

Last Modified:

29-Sep-2015 First Release

External Source Configuration

Once configured, an external source appears in VNA dialogs as though it were an internal source. This capability requires Frequency Offset Mode (FOM) Option 009.

In this topic:

- [How to Configure an External Source](#)
- [External Source Configuration dialog](#)
- [Trigger Settings and Physical Connection diagrams](#)
- [Generic Source Commands dialog](#)

Configure an External Source

How to Configure an External Source

Important: Create an External Source device by name (one-time). [Learn how.](#) (Separate topic)

VNA Applications have additional methods of launching this dialog.

Using **Hardkey/SoftTab/Softkey**

1. Press **Setup** > **External Hardware** > **External Device...**
2. Click **Device Properties** to [Configure the External Source](#).

Programming Commands

See Remotely Specifying a Source Port

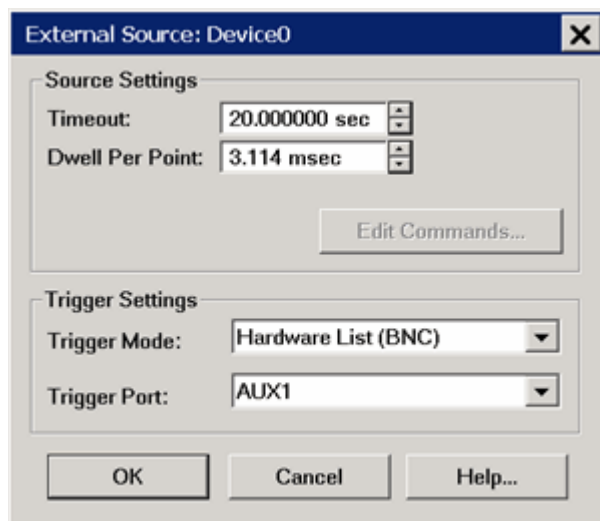

External Source Configuration Dialog Box Help

This dialog box is used to make external source settings.

Important Notes about External Sources

- First create an External Source (device) by name (one-time). [Learn how.](#)(Separate topic)
- Once you create and activate an external source from the [Configure an External Device](#) dialog, it becomes available from the following VNA dialog boxes as well as the softkeys and entry toolbar, as if it were an internal VNA source.

Use the following dialogs to set the state, frequency, and power level of the external RF source:

- [Power and Attenuators dialog](#)
- FOM dialog
- [New Trace/Receivers tab dialog](#)
- By default, an external source is **de-activated** when the VNA is Preset or when a Instrument State is recalled. This behavior can be changed with a Preference setting.
- External Keysight sources are usually limited to 1601 points with List-sweep mode. To 'work around' this limitation, divide the measurement among multiple channels. For example, to attain a sweep of 3200 points, create two channels of 1600 points. You can also use manual source control which supports Step-sweep mode. In this mode an external source can have up to 65,535 points. See Synchronize an External Source for help with manual source control.
- External sources should always share the same 10 MHz Reference signal as the VNA. Connect a BNC cable from the VNA 10 MHz Ref Output to the External Source Input.
- All newly-activated sources are preset, with source power OFF. Source power must be turned ON in the [Power dialog](#). Frequency Offset must be enabled in the FOM dialog.
- The same source can NOT be used more than once in the same channel.
- The VNA automatically controls all trigger settings for the external source.
- [See EXG Sources configuration note.](#)

Source Settings

Timeout (sec) - Sets a time limit for the source to make contact with the VNA. If this time limit is exceeded, the VNA stops the measurement procedure and displays the following error message.

EXECUTION ERROR;OPC QUERY TIMEOUT ERROR: FREQUENCY NOT SETTLED

If this occurs, check the connections between your VNA and external source.

Dwell per point (ms) - Applies a dwell in Hardware List triggering ONLY. Set the time (in milliseconds) the external source will wait before data acquisition.

Edit Commands - Provides a method to send SCPI commands to **AGGeneric** (not listed) sources.

Trigger Settings and Physical Connection Diagrams

Note: The VNA controls ALL external source trigger settings automatically (except for those on this dialog). All settings in the [External Trigger](#) dialog are ignored.

Trigger Mode

Software CW (GPIB) - Slowest method.

- The external source receives each CW frequency from the VNA over GPIB, USB, or LAN. No other trigger cables are required. Although a Trigger Port selection may be available, it is NOT used.

Hardware List (BNC) - Fastest method.

- NOT available for AGGeneric (not listed) sources.

- The external source receives a list of CW frequencies from the VNA, then receives trigger signals through a rear-panel connector when appropriate from the VNA.
- If the number of data points used in the measurement exceeds the capability of the external source, the VNA automatically switches to Software CW (GPIB) trigger mode. This will slow the measurement significantly.
- When daisy-chaining multiple sources, the source to receive the Trigger signal from the VNA must be the first source listed in the **Selected** column of the External Device Configuration dialog. Devices are listed in the order in which they are created. You may have to delete, then re-create a source to move it down on the list.

Trigger Port - Used ONLY for Hardware List Trigger Mode. Select the VNA rear panel connector to be used for triggering. The sources must be connected as follows:

- For ONE external source connect directly using AUX 1 or AUX 2 trigger pairs. See rear panel Aux connectors.
- For multiple sources, connect using the following daisy-chain image.

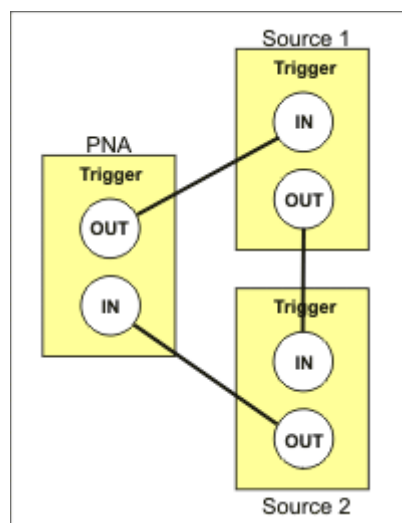

Notes:

- Source 1, which receives the trigger out of the VNA, must be the first source listed on the [External Devices Configuration](#) dialog box. Devices are listed in the order in which they are created. You may have to delete, then re-create a source to move it down on the list.
- Configure/translate **EXG sources** as follows:

EXG rear-panel label	For the VNA:
Trig 1	Trig In
Trig 2	Trig Out

Generic Source Commands

Operation complete (*OPC): *OPC

Preset: *RST

Set CW Frequency: FREQ: CW

Set CW Sweep Mode: FREQ:MODE CW

Set Power: POW

Set Power State: POW:STAT

OK Cancel

Generic Source Commands Dialog Box Help

Enter the SCPI commands that control the following functions on AGGeneric (not listed) source. A field without a SCPI command entered will be ignored and that function will not be set.

Note: Old signal sources that cannot be controlled with SCPI commands are not supported.

To launch this dialog, click **Edit Commands** on the [External Source Properties](#) dialog.

Operation Complete (*OPC)

Preset - Presets the source.

Set CW Frequency - Sets CW Frequency.

Set CW Sweep Mode - Sets source sweep mode.

Set Power - Sets source power.

Set Power State - Turns power ON or OFF.

Last Modified:

29-Sep-2015 First Release

Configure a Power Meter As Receiver (PMAR)

When a power meter is configured as a VNA receiver (in [standard measurement channels](#) ONLY), you can

- Extend the number of measurement receivers
- Use the power meter as a scalar detector
- Monitor the power at any point in a measurement system
- Use multiple power meters in a [Guided Power Cal](#) to cover a wide frequency range
- Use the power meter to level the stimulus power at any point in a measurement system
- Use the power sensor as a PMAR device to confirm the accuracy of a Source Power Cal [Learn how](#)

Once configured, a power meter can be used like any other VNA receiver in the following dialogs:

- [New Trace/Meas dialog](#) - used in Ratioed and Unratioed measurements.

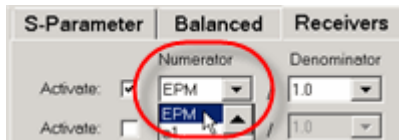

- Receiver Leveling
- Frequency Offset Mode - Extend frequencies beyond VNA

See Also

- [Supported Power Meters](#)
- Important first-time USB connection note

How to Create and Configure a PMAR Device

VNA Applications have additional methods of launching this dialog.

Using **Hardkey/SoftTab/Softkey**

1. Press **System** > **External hardware** > **External Device...**
2. Create a PMAR device by name (one-time).
3. Click **Device Properties** to [configure the Power Meter/Sensor](#).

◀ **Programming Commands** ▶

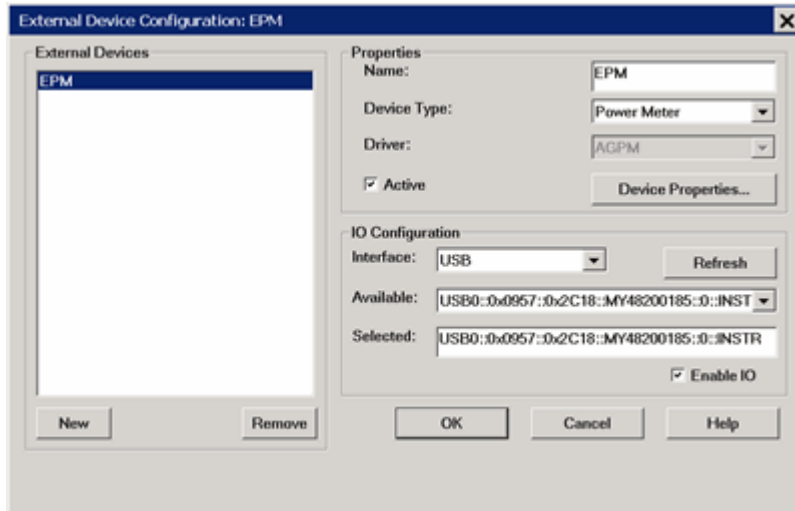

External Device Configuration Dialog Box Help

This dialog allows you to create and configure a power meter to be used as a receiver by the VNA. Once you create and configure a power meter from this dialog box, it becomes available from VNA dialog boxes as well as the softkeys and entry toolbar, as if it were an internal VNA receiver.

- This dialog is ALSO used to configure an **External Source**. [Learn more](#).
- To configure a single power meter for a Source Power Cal, use the [Power Meter Settings](#) dialog.

Important Notes:

- By default, an external PMAR device is **de-activated** when the VNA is Preset or when an Instrument State is recalled. This behavior can be changed with a Preference setting so that it remains active through a Preset or Instrument State recall.
- PMAR configuration is NOT saved in an Instrument State file. Therefore, recalling a state file that refers to a device that has been removed or recalling a state file on a different VNA will result in a "Device configuration not found" error.

External Devices

The devices that are currently configured appear in this list. The number of devices that can be configured is limited by the specified Interface.

New - Click to create a new PMAR configuration. The default name is Device<n>, where <n> is the next number for 'Device'.

Remove - Click to remove the selected device from the list.

Properties

Name - Enter a device name as it will appear when referring to this device in all VNA dialog boxes. Edit the name at any time. Duplicate names are not allowed.

Notes:

- Because External Devices can be used with FOM ranges, do NOT name an external device any of the following FOM range names: "primary", "receivers", or "source", "source1", "source2" and so forth. Learn more about FOM ranges.
- Do NOT use a parameter name, such as "S11, or "R1".

Device Type - Select **Power Meter**.

Driver - Use **AGPM** for all Keysight Power Meters. See [Supported Power Meters](#)

Active - Check to make the device available for use in the FOM, New Trace, and Receiver Leveling dialogs. An instrument state that is saved with an Active device (checked) will include the device in the state file. Otherwise, if the Active box is cleared, the device will NOT appear in the state file.

Note: Multiple PMAR configurations for the same physical device can be Active and Enabled.

Device Properties - Click to launch the [Configure Power Sensor](#) dialog.

IO Configuration

Interface Select the interface that is used to connect the device to the VNA. These devices will then appear in the 'Available' field. Choose from:

- **GPIB** - Devices connected to the System Controller GPIB port.
- **USB** - Devices connected to the VNA USB ports. See Important First-time USB connection note.
- **Aliases** - Devices that are connected to ANY interface for which you created an alias. See [Configure Alias and LAN devices](#).
- **LAN** - Devices connected to a network using a LAN connection. The VNA must also be connected to the network. **Note:** Devices connected to LAN must first be configured in Keysight IO libraries before they will appear on the Available list. See [Configure Alias and LAN devices](#).

Available - Shows a list of devices that are connected to the specified IO Interface.

Refresh - Click to rescan the specified interface for devices.

Selected - Enter the IO configuration or select from the available list of IO Interfaces found.

Enable I/O - Clear this box to disable communication with the selected device. You would do this to configure a device that is not yet connected to the VNA.

- Communication with devices is attempted when **Enable I/O** is checked, **Active** is checked, and **OK** is pressed.
- If communication with a device is lost, the affected channels are put into Hold.
- When communication is attempted, devices with **Enable I/O** checked are queried for limits for frequency, power, and number of points. If there are limit problems, the VNA sends an error and the affected channels are put into Hold. These limits are enforced by the dialog box in which they are set. Resolve the reported limit problem and then restore the triggering.
- Communication is also attempted when clicking the **Settings** button on the [Configure Power Sensor](#) dialog. You can not change any of the sensor settings unless **Enable I/O** and **Active** are checked and communication is possible with the sensor.

Configure Alias and LAN Devices

Use this procedure to configure a device using a LAN interface. Also use for ANY device for which you want to set an alias (easily-recognized) name. The alias name appears in the Available field when Aliases is selected as the Interface.

1. On the VNA, minimize the VNA application.
2. In the system tray (lower-right corner) right-click the IO icon, then click **Keysight Connection Expert**.

To Add a LAN Device:

1. In ACE, click  Add Instrument .
2. Select Add LAN Instrument (TCPIP0) or USB0, then click OK.
3. Click, then enter the IP address of the external source.
4. Click Test Connection to verify communication.
5. Click **OK**.

To create an Alias for a connected device:

1. In the list of connected instruments, right click the instrument, then **Add VISA Alias**.
2. Enter the same Device Name that was, or will be, used in the [External Device Configuration](#) dialog.

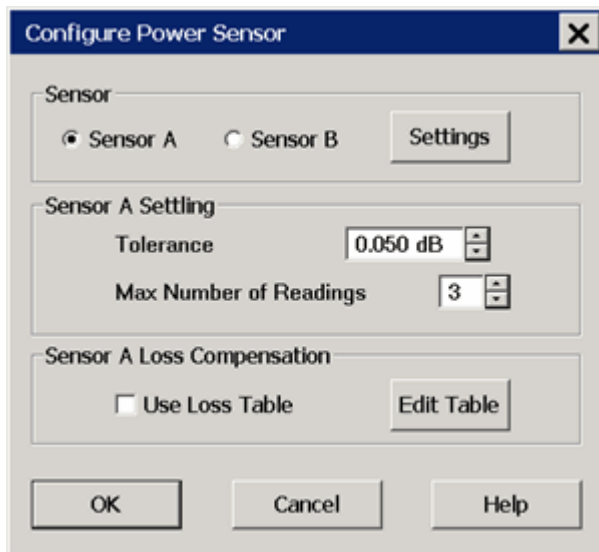

Power Sensor Configuration Dialog Box Help

Programming Commands

To launch this dialog, with the PMAR device selected in the [External Device Configuration](#) dialog, click **Device Properties** .

This dialog is used to configure a power meter / sensor for use as a receiver.

To configure a single power meter for a Source Power Cal, use the [Power Meter Settings](#) dialog.

About Power Sensor Calibration

PMAR traces are NOT calibrated using standard VNA calibrations, including response corrections.

PMAR traces are calibrated using methods that are appropriate for the selected sensor. Follow the proper guidelines for zeroing or calibrating the sensors that are in use. Check to ensure that the selected sensor is appropriate for the frequency range and the power level at which PMAR measurements occur.

The VNA does not automatically prompt you to perform a calibration.

To calibrate a power sensor, click **Settings** on this dialog box, then click **Zero/Calibrate Sensor**. [Learn more](#).

Note: By default, a PMAR is de-activated when the VNA is Preset or when a Instrument State is recalled. This behavior can be changed with a Preference setting.

Sensor

For power sensors that are connected to a power meter, select a sensor to configure.

Settings - Click to launch the [Power Sensor Settings](#) dialog.

When pressed, communication with the sensor is tested. Sensor settings can NOT occur unless **Enable I/O** is checked on the [External Device Configuration dialog](#), and the sensor is properly connected and configured.

Sensor Settling

Each power meter reading is "settled" when either:

- two consecutive meter readings are within this Tolerance value **or**
- when the Max Number of Readings has been met.

The readings that were taken are averaged together to become the "settled" reading.

Tolerance - When consecutive power meter readings are within this value of each other, then the reading is considered settled.

Max Number of Readings - Sets the maximum number of readings the power meter will take to achieve settling.

Sensor 'N' Loss Compensation

Use Loss Table - Select this checkbox to apply loss data to Source Power calibration correction (such as for an adapter on the power sensor).

Edit Table - Invokes the [Power Loss Compensation](#) dialog box.

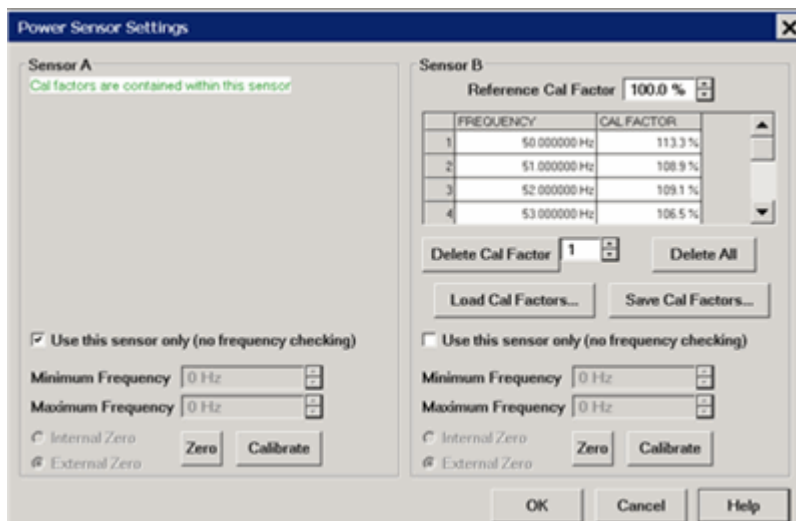

Power Sensor Settings Dialog Box Help

This dialog appears when you click the **Settings** button on the [Configure Power Sensor](#) dialog.

Note: Be sure that the frequency range of your power sensor covers the frequency range of your measurement. This does NOT occur automatically.

Sensor A (B) - Displays one of the following messages depending on type of sensor.

- **Not connected** - The VNA is not detecting a power sensor.
- **Cal factors are contained within this sensor** - Internal Reference Cal Factor and Cal Factor data are loaded automatically. The following table settings do not apply.
- **Sensor Data** - Allows the following entries for power sensor data:
 - **Reference Cal Factor** - Specifies the Cal Factor for the 50 MHz reference signal.
 - **Cal Factor Table** - Specifies the frequency and corresponding Cal Factor for the sensor.
 - **Delete Cal Factor** - Deletes the indicated row in the table.
 - **Delete All** - Deletes all data in the table.
 - **To Add a Row** to the table, click on a row in the table and press the down arrow on either the VNA front panel or keyboard. A row is added to the bottom of the table. The table is automatically sorted by frequency when OK is pressed.

Load Cal Factors - Click to load cal factors from a *.csv file that you create from the cal factors that appear on the sensor. The first line of the file **MUST** have the reference Cal Factor (typically 100), followed by Freq/Cal Factor pairs as show in the following image:

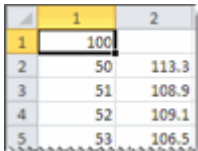

	1	2
1	100	
2	50	113.3
3	51	108.9
4	52	109.1
5	53	106.5

Save Cal Factors - Click to save the cal factor table to a *.csv file.

Limit Frequency Range

- Check to limit the use of the power sensor to those within the Minimum and Maximum frequency values.
- Clear to use the power sensor for all measurements. If the measurement frequency is not within the Minimum and Maximum frequency values, the closest min or max correction data is used for the measurement.

Minimum Frequency - Specifies the minimum frequency range for the sensor.

Maximum Frequency - Specifies the maximum frequency range for the sensor.

Zero and Calibrate the Power Sensor

For highest accuracy, Zero AND Calibrate the power sensor before measuring data. Follow prompts that may appear.

Zero - If the following settings are 'greyed', Internal or External zeroing is selected automatically based on the power meter/sensor model. Otherwise, select the appropriate type of zeroing to perform, then press **Zero**.

- **Internal Zero** - A switch inside the power sensor removes the sensor from the incident power.
- **External Zero** - Requires that you physically remove the sensor from incident power.

Note: for the U2000 Series USB power sensors

Calibration is NOT available. Select External Zero ONLY when the power to be measured is **below** the specified level. Otherwise, the U2000 series performs internal zeroing automatically when needed. See your power sensor documentation for more details.

- U200xA - below -30 dBm

- U200xH - below -20 dBm
- U200xB - below 0 dBm

If U2000 power sensor 'hangs' when external zeroing, upgrade the power sensor firmware to Rev. A.01.02.00 or higher to fix this problem.

Calibrate - Available when the selected sensor has calibration capability. Calibration involves measuring an internal 1 mW source.

- Keysight P-Series sensors have an internal reference so you can calibrate them without connecting to the meter's reference port.
- Keysight U2000 USB power sensors do not require calibrating.
- For other sensors, refer to the documentation to determine if it has calibration capability.

Press **Calibrate**, then follow the prompts.

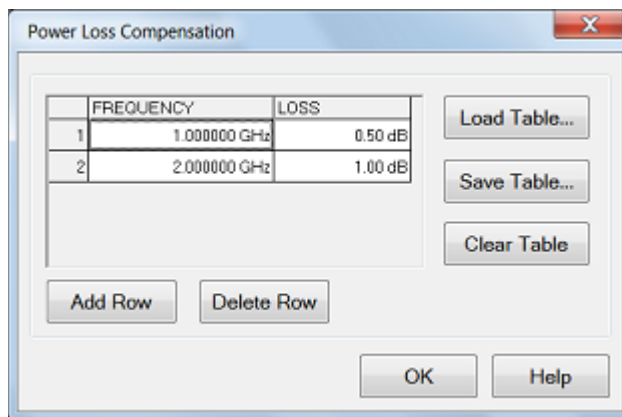

Power Loss Compensation Dialog Box Help

Add Row - Add a row at the end of row.

Delete Row - Delete the selected row.

To Edit a value, double-click in the cell to be edited.

Compensates for losses that occur when using an adapter or coupler to connect the power sensor to the measurement port. These components will be removed when the calibration is complete. To account for components that will remain during the measurement, use the [Power Offset setting](#).

The Frequency/Loss pairs define the amount of loss for the entire frequency range. For example, using the entries in the above dialog image:

- 0.5 dB is used to compensate power sensor measurements up to 1 GHz.
- Each data point between 1 GHz to 2 GHz is linearly interpolated between 0.5 dB and 1 dB.
- 1 dB is used above 2 GHz.
- A single frequency/loss segment is applied to the entire frequency range.

Frequency - Enter a frequency in Hz.

Loss - Enter a loss as a POSITIVE value in dB. To compensate for gain, use NEGATIVE values.

Load Table... - These values can be loaded from an S2P file using the Characterize Adapter/Fixture.

Note: Large segment counts with one or more power sensors can result in long load and close times for the VNA Application.

Save Table... - Save the table into csv file.

Clear Table - Clears all rows and data.

The Power Loss Compensation table survives VNA Preset and Power OFF. To NOT use Loss compensation, clear the Use Loss table checkbox on the [Configure Power Sensor](#) dialog.

[Use a PMAR Device to confirm a Source Power Cal](#)

[Learn how to create and configure PMAR device.](#)

After a Source Power Cal has been performed, use the same sensor as a configured PMAR to analyze the accuracy of the Calibration.

1. Create a PMAR device with the power sensor that will be used for the Source Power Cal.
2. Perform a Source Power Cal. [Learn how.](#)
3. Create an unratiod measurement with the PMAR device. [Learn how.](#)
4. With the power sensor still connected to the test port, monitor the corrected source power using [Min and Max markers](#) or the [Trace Statistics peak-to-peak](#) feature.

Last Modified:

29-Sep-2015 First Release

E5092A Test Set Control

The E5092A is a popular Keysight Technologies 7-port / 9-port test set. Although the test set was originally designed to work with the ENA Network Analyzer, it also works well with the VNA. This topic describes how to control the test set from the VNA. For more information about the test set, refer to your E5092A documentation.

- [Overview](#)
- [Connecting the E5092A](#)
- [How to make E5092A test set Control Settings](#)
- [Calibrating with the E5092A](#)

Other System Configuration Topics

Overview

When connected to the VNA, the E5092A test set provides Up to 10-port full crossbar measurement or maximum 22-port measurement capability. The E5092A can be configured to switch a different test set path for each VNA channel. When all channels have been configured, the entire measurement setup and calibration can be [saved to a .cst or .csa file](#) to be recalled later. In addition, the [Channel Settings Table](#) that is appended to a printed hardcopy of a measurement includes the E5092A Port Control settings.

Notes:

- Works with all 4-port VNA models.
- The E5092A test set has a maximum useful frequency of 20 GHz.
- The E5092A test set Control can be automated using [SCPI](#) commands.
- When [enabled](#), a second status bar row appears which indicates the test set that is being controlled and the current switch state.
- Test set path switching occurs just before a channel is triggered. If a [channel trigger state is Hold](#), switching for that channel does not occur.
- VNA sweep speed will be slightly slower when using the E5092A to switch measurement paths.

Connect and Configure the E5092A

The E5092A can be connected to any one of the VNA USB ports. When first installed, Windows will automatically launch the "Add New Hardware" wizard. Click **Next** to install the E5092A test set.

Note: See the power handling limitations of the VNA USB ports.

Connect the VNA test ports to the E5092A test ports. Match VNA test port 1 to E5092A test port 1, and so forth.

Selecting ID for E5092A

The VNA can control up to two E5092A test sets. Set the Instrument ID bit switch to 1 or 2. The test sets will then be identified automatically and referred to by the DIP switch setting on the E5092A rear-panel. Change the ID bit switch setting before connecting to the VNA USB.

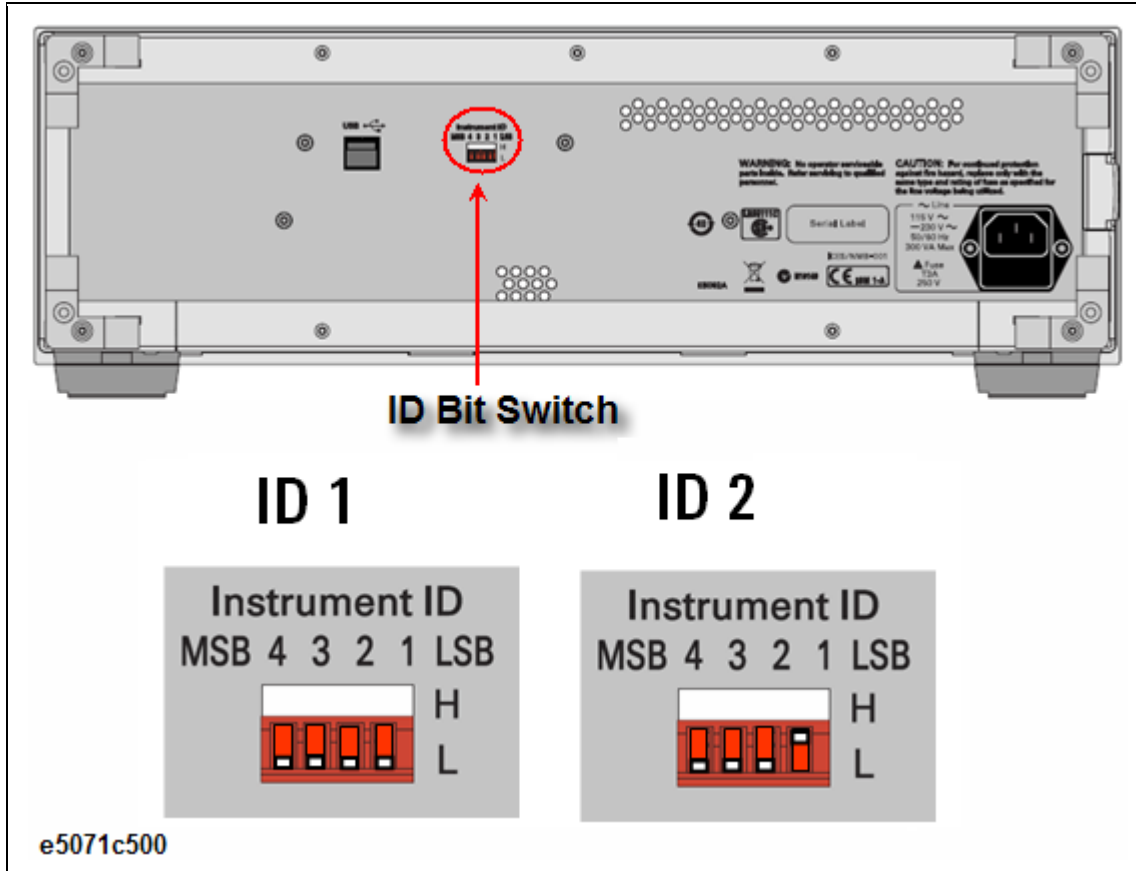

Power ON

Immediately after power-on, all of the port connection indicator LEDs of the E5092A go ON. Then, after the VNA detects the E5092A, the four LEDs that indicate the connected test ports remain ON. If the VNA is not powered on or if the E5092A is not connected using a USB cable, all of the LEDs stay ON.

How to make E5092A test set Control Settings

Using **Hardkey/SoftTab/Softkey**

1. Press **Setup** > **External Hardware** > **External Testset...**

No programming commands are available for this feature.

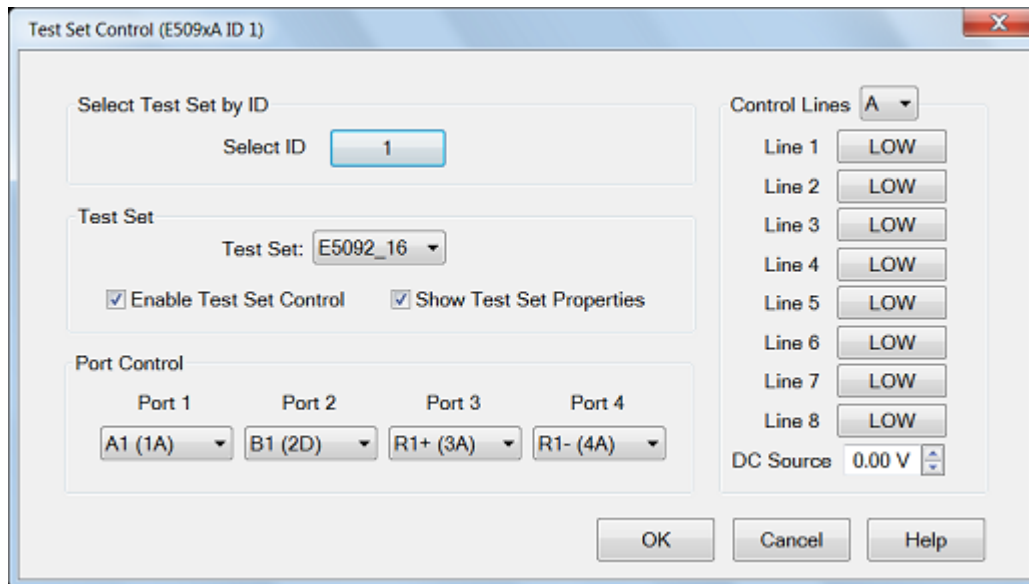

E5092A test set control dialog box help

The title of the dialog shows the test set model and ID number of the active test set..

Select ID ID of the test set to be configured. Up to two E5092A test sets can be controlled. Click to change test set ID. [Learn how to set the test set ID.](#)

Enable Test Set Control When cleared, port switching and control line settings are disabled. This selection affects all channels using the selected test set.

Selection	Configuration
E5092_13	Select the 13-port configuration of the E5092A
E5092_16	Select the 16-port configuration of the E5092A
E5092_22	Select the 22-port configuration of the E5092A
E5092_28	Select the switching independently in the E5092A
E5092_X10	Select the 10-port full crossbar configuration of the E5092A

Show Test Set Property When checked, the following status bar appears which indicates the test set that is being controlled and the current port control selection. For example, the following image shows the status bar when controlling an E5092A test set.

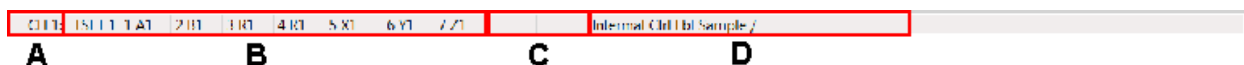

- A. Configured channel
- B. Port Control settings for E5092A
- C. Port Control settings for Z5623A K64
- D. Test set Label. E5092A control does not use this field. It is shared between [Interface Control](#) and External test set Control. The two labels are separated by /.

Port Control Controls **mapping** of Physical ports to Logical ports.

- Physical ports are the port numbers that are labeled on the test set front panel.
- Logical ports are the port numbers that are referred to by most of the VNA application prompts and dialog boxes.

Port Mapping Notes

- Port Control and Control Line settings affect the channel of the active (selected) measurement. These settings will occur as the channel is being measured.
- Correction is NOT turned OFF when port mappings are changed. However, the **calibration is NO LONGER VALID!**

Control Lines Specifies the values of individual control lines. These general purpose control lines on the test set front-panel can be used in your test setup. Each button toggles the control line HIGH and LOW. When first opened, the selections reflect the current control lines. See your test set documentation for more information about the control lines. Groups A to D are assigned as follows.

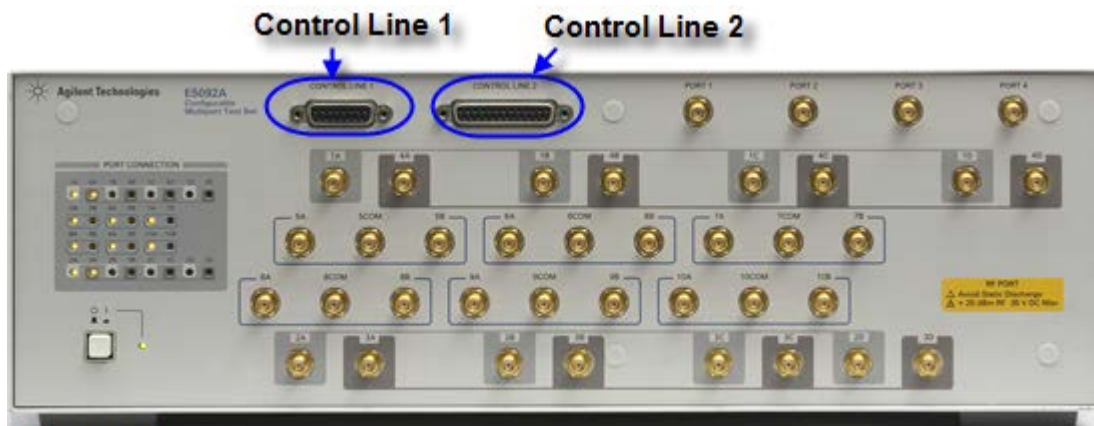

e5071c292

D-SUB 15pin Assignment

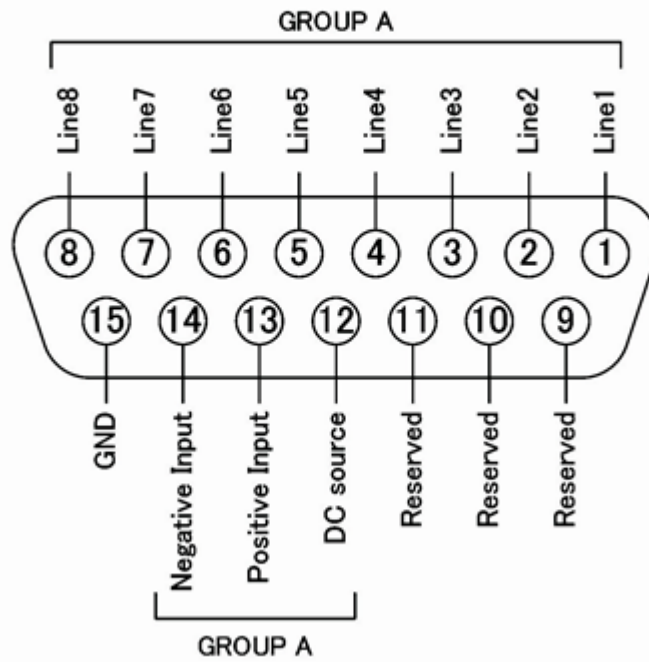

enamwa009

D-SUB 25pin Assignment

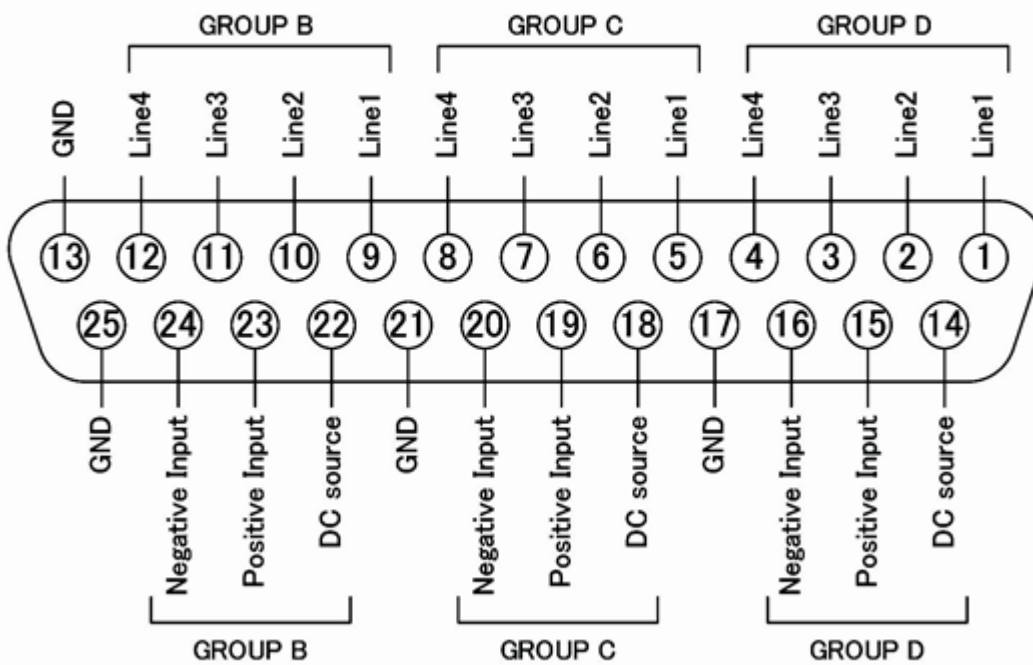

enamwa010

OK When clicked, the changes to the dialog box are implemented and the port selections and control values are immediately sent to the specified test sets. The Port Control and Control line settings are stored with other channel data and used when those channels are swept.

Cancel (or Escape) Changes to the dialog are not implemented and revert to the settings before the dialog box was opened.

Calibrating with the E5092A

The following are a few changes in the way you calibrate the VNA with the E5092A connected:

1. Create the measurements for the channel and configure the Port Control (switching) on the E5092A Test Set Control dialog box. Enable **Show Test Set Property**.
2. To calibrate, start the Smart Calibration.
3. Select the DUT connectors that are used at the E5092A measurement reference plane.
4. When prompted to connect a standard to a VNA port, instead connect the standard to the E5092A port as indicated on the test set status bar. For example, when the cal wizard prompts to connect the standard to port 1, if the status bar indicates **1 A**, the connect the standard to port A of the E5092A.



About Error Messages

VNA errors and Operating System errors are displayed and logged in an error file. You can choose how to display VNA errors, or choose to not display VNA errors at all.

- [Error Display](#)
- [View Error Log](#)
- [List of VNA Errors](#)
- [SCPI Errors](#)

Other System topics

Error Display

By default, error messages appear on the status bar. You can choose to have them stay on the screen until you click an OK button, or have them not appear at all. When they stay on the screen, a Help button is available to provide further assistance.

How to select the display of Error Messages

Using **Hardkey/SoftTab/Softkey**

1. Press **System > Help > Error Display...**

◀ **Programming Commands** ▶

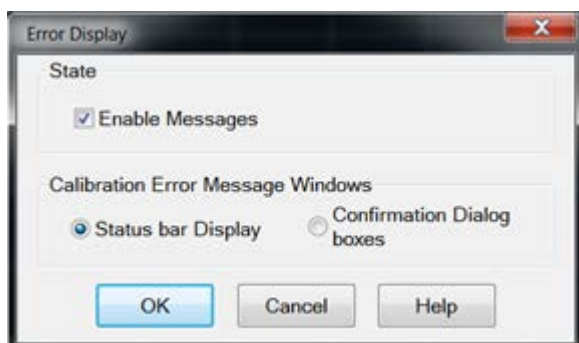

Error Display dialog box help

On Preset, these settings revert to their defaults (enabled).

Enable Messages Check to display all VNA error messages as they occur. Clear to suppress the display of VNA error messages. You can still view them in the [error log](#).

Calibration Error Message Windows

Status Bar Displays error messages on the status bar. You can then view the message in the [error log](#) and get further assistance.

Confirmation Dialog boxes Displays error messages in a standard dialog box. You then choose

OK or **Cancel** to close the dialog box, or press Help to get further information on the error message.

View Error Log

The VNA Error Log is a list of events that have occurred in exception to SCPI errors/Power On Test errors, etc. (Events are used in programming the VNA using COM.) VNA errors is a subset of VNA events. Only events with severity codes of ERROR are displayed on the VNA screen as they occur. From the error log, you can access further help with an error by selecting the error and clicking Help.

How to view the Error Log

Using **Hardkey/SoftTab/Softkey**

1. Press **Sweep** > **Help** > **View Error Log**.

No programming commands

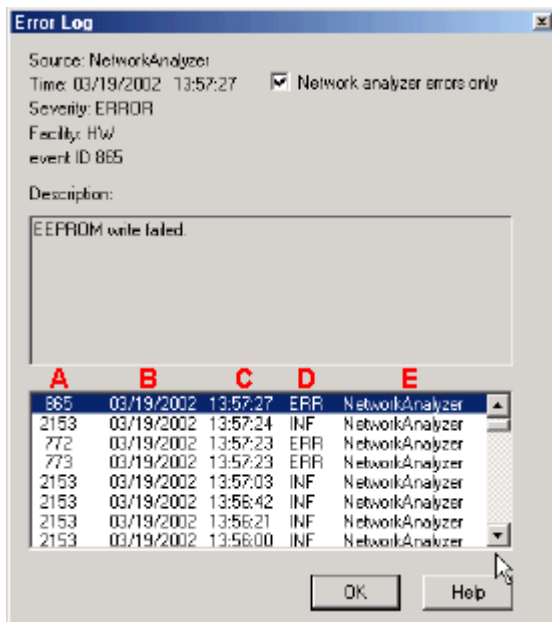

Error Log dialog box help

Network analyzer errors only Select to view only VNA errors. Clear to view all errors that occur on all applications of the computer.

Description Error message that appears on the VNA screen.

A - Event ID Error message number

B - Date the Error occurred

C - Time the Error occurred

D - Severity Code - All events have one of the following severity codes:

- SUCcess - the operation completed successfully
- INFormational - events that occur without impact on the measurement integrity

- WARning - events that occur with potential impact on measurement integrity
- ERRor - events that occur with serious impact on measurement integrity

E - Application in which the error occurred.

OK Closes the Dialog box

Help Provides further information on the selected Error message

To clear the Error Log:

1. From the **System** > **Main** menu click **Minimize Application**
2. On the desktop, select **Start** > **Control Panel**
3. On the Control Panel, click **Administrative Tools**
4. On the Administrative Tools window, click **Event Viewer**
5. On the Event Viewer window, right-click **Application**
6. Select **Clear Log**
7. If you want to save a file with the contents of the Event Log, click **Save and Clear**. Otherwise, click **Clear**

To restore the VNA application, click on the VNA Analyzer taskbar button at the bottom of the screen

Last Modified:

29-Sep-2015 First Release

Display Colors

You can modify the colors that are used to draw various elements on the VNA screen and on a hardcopy print of the display.

- [Display Colors](#)
- [Print Colors](#)
- [Print Preview Procedure](#)

See Also

[Print Preview](#)

Display Colors

How to modify Display Colors

Using **Hardkey/SoftTab/Softkey**

1. **Display** > **Display Settings** > **Display Colors....**

OR

1. Press **System** > **System Settings** > **Preferences....**
2. Click **Disp Colors...** on Preferences dialog box.

No programming commands are available for this feature.

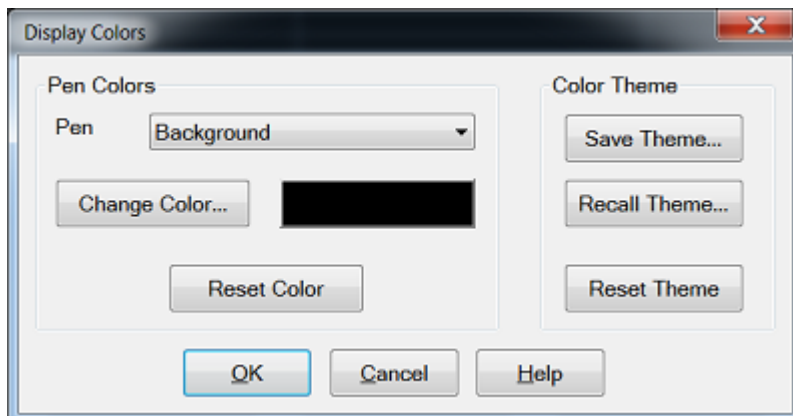

Print Colors

How to modify Print Colors

Using **Hardkey/SoftTab/Softkey**

1. **System** > **Print** > **Print Colors....**

OR

1. Press **System** > **System Settings** > **Preferences....**

2. Click **Print Colors...** on Preferences dialog box.

◀ **Programming Commands** ▶

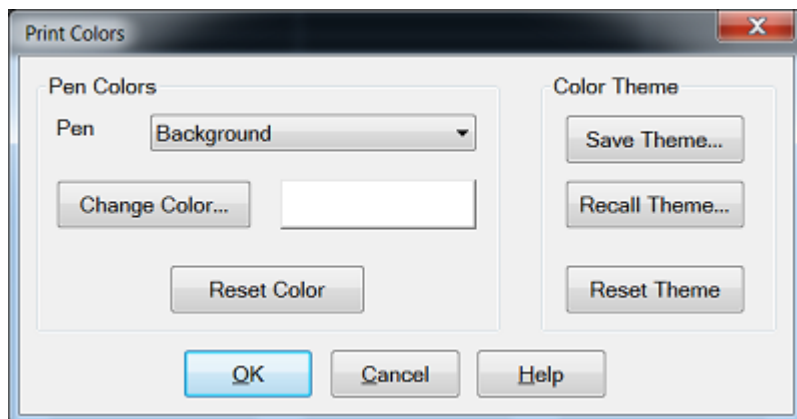

Display Colors and Print Colors Dialog Box Help

The Display Colors and Print Colors dialog boxes function in exactly the same manner. See [Print Preview](#) procedure below.

Pen

"Pen" is a term used to describe the various elements. Each pen can have a unique color.

You can change the color of the following pens:

- Background - The background color of the inactive windows.
- Active Background - The background color of the active window.
- Grid - The inner lines of all grids in all windows, and the grid frame in inactive windows.
- Active Labels, Grid Frame - The labels and grid frame colors in the active window. **Note:** when this pen is selected, the current window becomes inactive. Therefore, changes for this pen color will not be visible until **OK** is pressed.
- Inactive Window Labels.
- Failed Trace - [Limit Line](#) failed traces or failure indicators (dots) and the word Fail.
- The following pens for up to 8 Traces:
 - Data and Limits
 - Memory trace
 - Markers
 - Memory markers

About Trace Pens

'1st Trace' is NOT always Trace1 (**Tr1**). For example, the first trace in a window might be **Tr2** which is drawn with the "1st Trace" pen.

The first 8 traces are drawn with the defined pen colors. The next eight traces reuse the same colors, and so forth. For example, if all traces are numbered sequentially, the 9th and 17th traces are drawn using the same color as the 1st trace.

Change Color - Click the button or the color swatch to launch the [Change Color](#) dialog.

Reset Color - Restores the default color for the selected pen.

Color Themes

A theme is a complete set of pens and their colors. The current theme persists until you change it. Themes can also be saved to a file and then later recalled. By default, the file is saved in internal hard disk in the C:\ProgramData\Agilent\Network Analyzer\Colors folder with save type as *.colors.

- **Save Theme...** - Click to save the current set of pens to a file.
- **Recall Theme...** - Click to recall and use a saved theme.
- **Reset Theme...** - Click to recall the default VNA color theme.

The colors for the following Display elements can NOT be changed: toolbars, softkeys, menus, dialogs and popup messages.

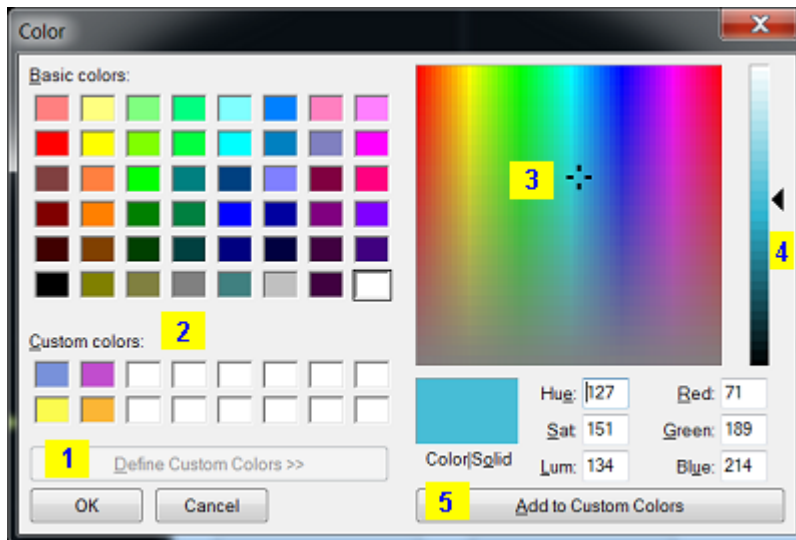

Change Color Dialog Box Help

To use a basic color, click the color from the 'Basic colors' palette and then click **OK**.

To define and use a custom color:

1. Click **Define Custom Colors>>** to open the right side of the dialog.
2. Optionally, pick a Custom color slot to replace. Otherwise, the replacement will occur at the first slot location and continue with subsequent custom color definitions.
3. Click the color pane, or drag the crosshairs, to the location of the custom color.
4. Drag the arrow to the desired saturation level of the custom color.
5. Click **Add to Custom Colors**.
6. Continue to define more colors or click **OK** to close the Color dialog box.

After a custom color has been assigned to a VNA pen, the custom color can be changed. The VNA pen color remains unchanged.

Print Preview Procedure

Use the following procedure to preview your Print Colors on the VNA screen:

1. From the Print Colors dialog box, select **Reset Theme** and then **Save Theme....** Name the new theme "MyPrintTheme.colors". This will give you a starting point equal to the default print colors.
2. Launch the Display Colors dialog box, select **Recall Theme**, then select "MyPrintTheme.colors". The display will now show the default print theme.
3. Customize the display colors. You will be previewed how the hardcopy will appear when printed.
4. Save the customized display colors to "MyPrintTheme.colors".
5. Go to the Print Colors dialog box and recall "MyPrintTheme.colors".

Frequency Blanking

For security reasons, you can prevent frequency information from appearing on the VNA screen and printouts.

How to set Frequency Blanking

Using **Hardkey/SoftTab/Softkey**

1. Press **System** > **Main** > **Security....**

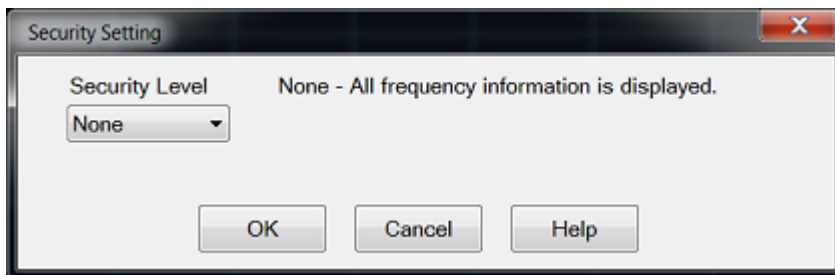
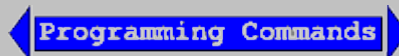

Security Setting Dialog Box Help

Notes:

- To learn how to erase memory before moving VNA out of a secure area, see <http://na.tm.Keysight.com/pna/security.html>.
- An ECal Data Wipe Utility destroys all user data per US DoD 5220.22-M. Learn more at <http://na.tm.Keysight.com/pna/apps/applications.htm>
- VNA 'Undo' is disabled with **High** and **Extra** security levels. [Learn more.](#)

Security Levels

None - All frequency information is displayed.

Low - No frequency information is displayed. Return to this dialog box to re-enable display of frequencies.

Frequency information is blanked from the following:

- Display annotatio
- Calibration properties
- All tables
- All toolbars
- All printouts
- [External sources](#) - See Also: Preference to Deactivate External Devices on Preset

Note: Frequency Blanking is fully supported ONLY on Keysight MXG sources with option 006. On MXG models without option 006 and all PSG models, the window state is turned OFF. When the

“local” button is clicked on the source, then frequency is re-displayed.

High - No frequency information is displayed. Only Preset or recall of instrument state can re-enable display of frequencies.

Low security level settings PLUS:

- [GPIB console](#) is inactive.

Extra - Frequency information is not displayed and will not be saved to ASCII file types. Only Preset or recall of instrument state can re-enable display of frequencies.

High security level settings PLUS:

- All ASCII [data saving](#) capability (.snp, .prn, .cti) is saved without frequency information. The X-axis information is replaced with data point numbers.
- Mixer setup files (*.mxr) can NOT be saved.

For ALL security levels:

Frequency information is **NOT** blanked from the following:

- Service Adjustment Programs.
- SCPI programs.

Instrument State and Cal Sets

The security level is always saved and recalled with an instrument state. However, the instrument state may contain a Cal Set or link to a Cal Set. [Learn more](#). This may influence the security level when the instrument state is recalled.

- When a new Cal Set is created at the end of a calibration, the current system security level is stored with it.
- The only way to change an existing Cal Set's security level is by writing a new calibration into the Cal Set.
- When later applied to a channel, if the Cal Set has a **higher** security level than the current system security level, the system security level will become upgraded to that of the Cal Set.
- When saving an instrument state to either a *.csa or *.cst file, the security levels of the system and Cal Set are saved separately. When recalled, the higher security level of the two is applied.
- To view the security level of a Cal Set, see [Cal Set Properties](#).

Re-displaying frequency information

- When in **Low** security level, do any of the following:
 - Revisit this dialog box and select **None**.
 - Perform an [instrument preset](#).
 - Recall an Instrument State/Cal Set with security level of **None**.
- When in **High** or **Extra** security level, do any of the following:
 - Perform an [instrument preset](#).
 - Recall an Instrument State/Cal Set with security level of **None**.

Last Modified:

E5080A

29-Sep-2015 First Release

Interface Control

The Interface Control feature allows you to send remote commands and data to the following VNA rear-panel Interfaces: GPIB, Material Handler I/O, Test Set I/O, and Auxiliary I/O.

- [Overview](#)
- [How to Access Interface Control Settings](#)
- [Interface Control Dialog Box](#)

Other System Configuration Topics

Note: Interface Control can be used ONLY with Standard channels; NOT with Application channels.

Overview

The Interface Control feature allows you to send data to control external equipment such as GPIB instruments, a material handler, test set, or other equipment, without needing to create a remote program. The VNA manages the timing and required interface setup. See Rear Panel Tour

- A unique set of control data can be sent for each channel. In addition, a unique set of control data can be sent before the channel sweep starts, and after the sweep ends.
- Interface Control settings can be saved and recalled from the [Interface Control dialog box](#), or with [Instrument State Save and Recall](#).
- Interface Control settings can be copied to other channels using [Copy Channels](#).
- Control data can only be WRITTEN to the interfaces, NOT READ from the interfaces.
- Control data is sent in the following order. This order cannot be changed.
 1. [GPIB Interface](#)
 2. [Dwell Time](#)

How to access Interface Control settings

Using **Hardkey/SoftTab/Softkey**

1. Press **Setup** > **Internal Hardware** > **Interface Control...**

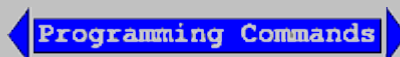

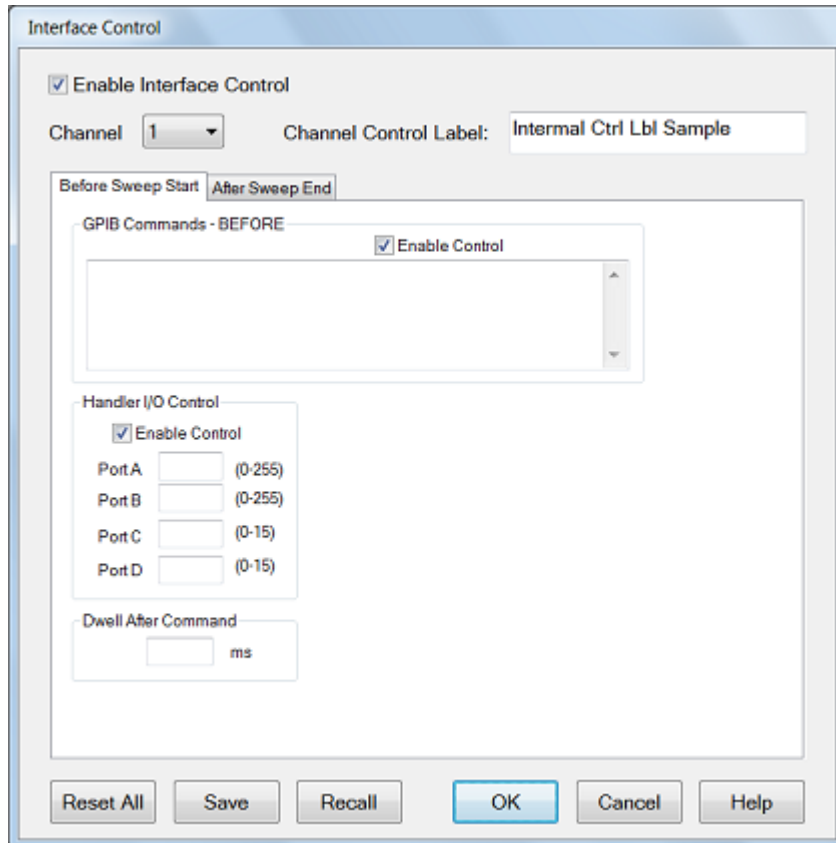

Interface Control dialog box help

See [Interface Control Overview \(scroll up\)](#)

An [Instrument Preset](#) will reset all of the fields to their default settings.

Note: If an error is encountered when sending Interface Control data, an error message is displayed on the VNA screen. The [Channel Trigger State](#) is set to Hold. You must fix the condition that caused the error, then change the Channel Trigger State to its original setting.

Enable Interface Control Enables and disables ALL Interface Control communication. When cleared (default setting) Interface Control is disabled and NO data is sent. To send data, the individual interfaces must also be enabled.

Channel Specifies the channel number for dialog settings. Each channel is configured individually. The list box shows the channels that currently have measurements. There must be at least one measurement present in order to make settings.

Channel Label Specifies the label (D in the following figure) to be displayed on the status bar at the bottom of the VNA screen. The status bar is automatically displayed when Interface Control is enabled.

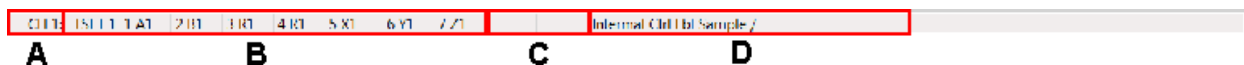

[Learn about the primary status bar.](#)

Before Sweep Start - After Sweep End Tabs

Commands / data for all four interfaces can be sent both Before Sweep Start and After Sweep End. However, they are configured and enabled on separate tabs of the Interface Control dialog box. For example, to send GPIB commands both Before and After a VNA sweep, the Enable Control checkbox must be selected and commands entered on BOTH the Before Sweep Start and After Sweep End tabs.

Before Sweep Start The data is sent BEFORE the first trace on the channel begins sweeping.

After Sweep End The data is sent AFTER the last trace on the channel completes sweeping.

GPIB Commands

Notes:

- GPIB instruments CAN be connected to the VNA using a [USB/GPIB adapter](#).
- GPIB Queries are NOT supported.

Enable Control Enables and disables sending commands out the GPIB interface.

Multi-line edit control Each line contains a GPIB command using the following syntax:

```
address  command
```

Where:

address a number between 0 and 31. The VNA will look through all of the GPIB interfaces for an instrument connected to the specified address. If an instrument with that address is not recognized, an error is returned.

command a GPIB command, with or without enclosing quotes. Enclosing quotes are ignored.

Address and command are separated by at least one space.

Commands should be separated by a new line, or carriage return. For example:

```
19 ":init:cont off"
16 init:imm
```

The front-panel **Enter** key inserts a new line into the field.

The number of GPIB commands that can be entered is limited only by the available memory of the VNA.

Handler I/O

Enable Control Enables and disables sending data out the Handler IO Connector (E5080A)

Ports A, B, C, D Sends values to the respective Handler I/O port. Although ports C and D are normally bidirectional, ONLY Output mode is allowed using the Interface Control feature. It cannot read from these, or any other, ports.

Dwell After Command Specifies a wait time, in milliseconds, after all commands to all interfaces are sent. Any positive integer is allowed. This is used to allow all external devices to settle before beginning a measurement. An erratic trace could indicate that more settling time is necessary.

Reset All Sets ALL fields on ALL channels to their default values.

Save and Recall Saves and recalls the contents of this dialog box. If the Interface Control dialog box is populated with settings during an [Instrument State Save](#), the settings are automatically recalled with the Instrument State settings.

Interface control uses an *.xml file type. An example file is stored on the VNA hard drive. You can recall it into the dialog, or you can open and edit it with a word processor, such as Word Pad.

OK Applies the settings and closes the dialog box.

Cancel Does not apply changes that were made, and closes the dialog box.

Last Modified:

29-Sep-2015 First Release

E5080A



Power Limit and Power Offset

- [Overview](#)
- [How to access Power Limit and Power Offset settings](#)

Other System Topics

Overview

Power Limit (Global scope)

Global power limit sets a maximum source power level for individual VNA ports. This value limits port power for all channels and all applications. Power levels that attempt to exceed the power limit is clipped at the limit.

Notes

- Components that are added to the RF path are accounted for by entering their loss (negative) or gain (positive) in the [Power Offset](#) section of the dialog box.
- VNA Applications may change RF path components. For example, IMD for Converters may change the combiner path and add an amplifier for LO input. Compensation is NOT made for these changes and port power may exceed the power limit or port power may be clipped unnecessarily.
- Power limiting does NOT clip power spikes that may occur during [frequency band crossings](#).
- External test set ports are also included for power limiting.

Power Offset (Channel scope)

Power Offset provides a method of compensating port power for added attenuation or amplification in the source path. The result is that power at the specified port, all dialogs, and annotation, reflects the added components.

How to access the Offsets and Limits settings

Also accessed through the VNA Preferences dialog.

Using **Hardkey/SoftTab/Softkey**

1. Press **Power** > **Leveling & Offset** > **Offset and Limits....**

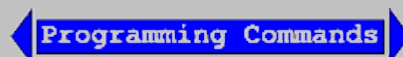

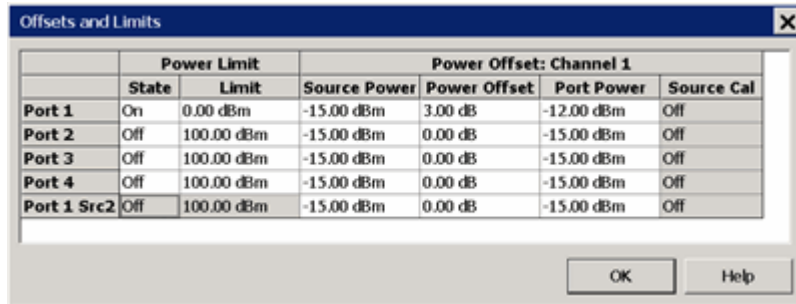

Offsets and Limits dialog box help

Click a WHITE cell to change values. **Shaded cells** can **NOT** be changed.

Remote commands can be sent to lock and unlock the dialog box (UI) settings.

Power Limit

Limits the source power at each VNA port for ALL channels. Use this feature to protect DUTs that are sensitive to overpowering at the input. Power levels that exceed the limit at the specified port are clipped at the limit and an error message is displayed on the screen.

The Power Limit settings survive [Instrument Preset](#). When an Instrument State is [recalled](#), the current Power Limit settings are applied to the recalled state.

To learn more, see [Power Limit Overview](#) (scroll up).

State / Limit

- **ON** - Power is limited to the adjacent value at the specified source port.
- **OFF** - Power is NOT limited to this value, but to the maximum power of the VNA source.

For VNA models with a second internal source, the **Port 1 Src2** Power Limit setting is NEVER available. Make the setting at the standard **Port 1**.

Power Offset

Power Offset provides a method of compensating port power for added attenuation or amplification in the source path. The result is that power at the specified port, all dialogs, and annotation reflects the added components.

- For amplification, use positive offset.
- For attenuation, use negative offset.

Important Note: Power Offset is added AUTOMATICALLY when a [Source Power Calibration](#), [Guided Power Cal](#), or [Power Compensation](#) is ON with Fixture Embed/Deembed. If you are NOT seeing the correct power level at your DUT, view the power Offset column in this dialog for unexpected offsets.

Optionally change the Source Power or Port Power values so that the following equation reflects your requirement:

$$\text{Source Power} + \text{Power Offset} = \text{Port Power}$$

Source Cal ON / OFF

OK Closes the dialog box.

Last Modified:

24-Oct-2014 Initial Release

Setting System Impedance

The system impedance can be changed for measuring devices with an impedance other than 50 ohms, such as waveguide devices. The VNA mathematically transforms and displays the measurement data as though the VNA ports were the specified impedance value. Physically, the test ports are always about 50 ohms.

How to change the System Impedance

Using **Hardkey/SoftTab/Softkey**

1. Press **Scale** > **Constants** > **System Z0**

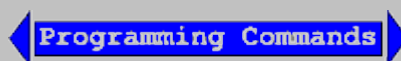

System Z0 softtab help

Allows you to change the system impedance (default setting is 50 ohms).

Z0 Displays the current system impedance.

For 75 ohm devices:

1. Change the system Z0 to 75 ohms.
2. Connect minimum loss pads (75 ohm impedance) between the analyzer and the DUT to minimize the physical mismatch.
3. Perform a calibration with 75 ohm calibration standards.

For waveguide devices

When selecting a Cal Kit with an impedance other than 50 ohms (Waveguide = 1 ohm), it is **NO LONGER NECESSARY** to change the [System Impedance](#) setting before performing a calibration. The impedance for the calibration is now derived from the Cal Kit ['Connector'](#) impedance setting.

Last modified:

29-Sep-2015 First Release

Rear Panel IO Connectors

Interface Control

The Interface Control feature allows you to send remote commands and data to the following VNA rear-panel Interfaces: GPIB, Material Handler I/O, Test Set I/O, and Auxiliary I/O.

- [Overview](#)
- [How to Access Interface Control Settings](#)
- [Interface Control Dialog Box](#)

Other System Configuration Topics

Note: Interface Control can be used ONLY with Standard channels; NOT with Application channels.

Overview

The Interface Control feature allows you to send data to control external equipment such as GPIB instruments, a material handler, test set, or other equipment, without needing to create a remote program. The VNA manages the timing and required interface setup. See Rear Panel Tour

- A unique set of control data can be sent for each channel. In addition, a unique set of control data can be sent before the channel sweep starts, and after the sweep ends.
- Interface Control settings can be saved and recalled from the [Interface Control dialog box](#), or with [Instrument State Save and Recall](#).
- Interface Control settings can be copied to other channels using [Copy Channels](#).
- Control data can only be WRITTEN to the interfaces, NOT READ from the interfaces.
- Control data is sent in the following order. This order cannot be changed.
 1. [GPIB Interface](#)
 2. [Dwell Time](#)

How to access Interface Control settings

Using **Hardkey/SoftTab/Softkey**

1. Press **Setup** > **Internal Hardware** > **Interface Control...**

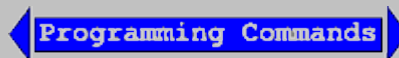

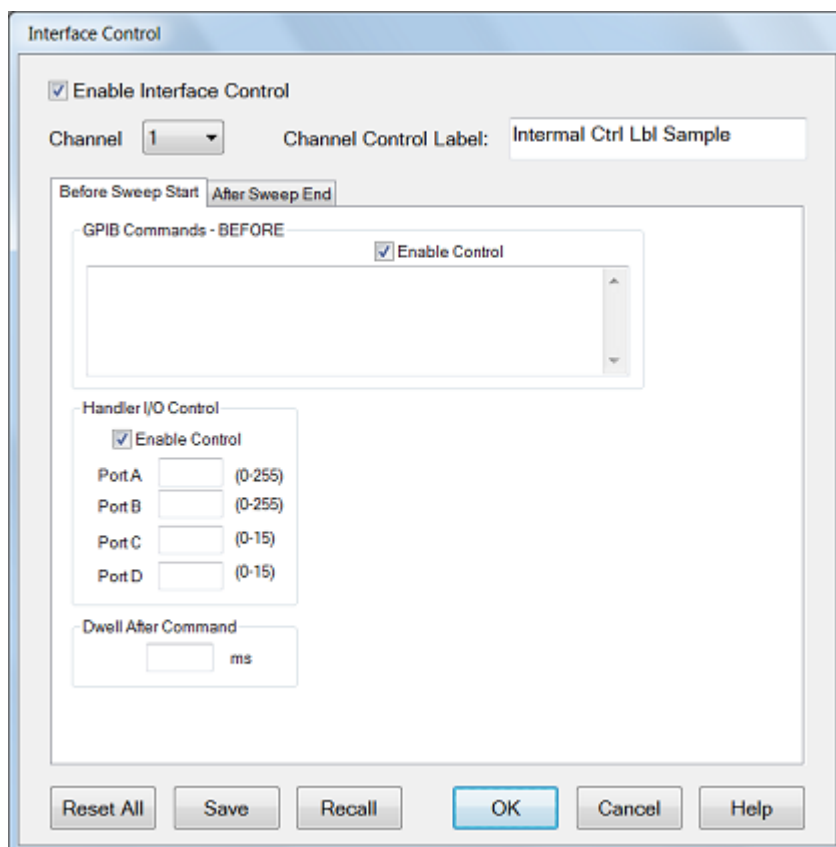

Interface Control dialog box help

[See Interface Control Overview \(scroll up\)](#)

An [Instrument Preset](#) will reset all of the fields to their default settings.

Note: If an error is encountered when sending Interface Control data, an error message is displayed on the VNA screen. The [Channel Trigger State](#) is set to Hold. You must fix the condition that caused the error, then change the Channel Trigger State to its original setting.

Enable Interface Control Enables and disables ALL Interface Control communication. When cleared (default setting) Interface Control is disabled and NO data is sent. To send data, the individual interfaces must also be enabled.

Channel Specifies the channel number for dialog settings. Each channel is configured individually. The list box shows the channels that currently have measurements. There must be at least one measurement present in order to make settings.

Channel Label Specifies the label (D in the following figure) to be displayed on the status bar at the bottom of the VNA screen. The status bar is automatically displayed when Interface Control is enabled.

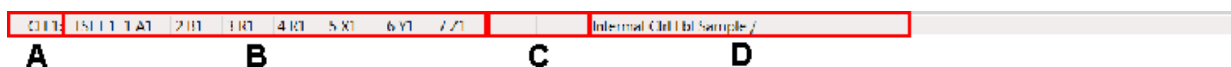

[Learn about the primary status bar.](#)

Before Sweep Start - After Sweep End Tabs

Commands / data for all four interfaces can be sent both Before Sweep Start and After Sweep End. However, they are configured and enabled on separate tabs of the Interface Control dialog box. For example, to send GPIB commands both Before and After a VNA sweep, the Enable Control checkbox must be selected and commands entered on BOTH the Before Sweep Start and After Sweep End tabs.

Before Sweep Start The data is sent BEFORE the first trace on the channel begins sweeping.

After Sweep End The data is sent AFTER the last trace on the channel completes sweeping.

GPIB Commands

Notes:

- GPIB instruments CAN be connected to the VNA using a [USB/GPIB adapter](#).
- GPIB Queries are NOT supported.

Enable Control Enables and disables sending commands out the GPIB interface.

Multi-line edit control Each line contains a GPIB command using the following syntax:

```
address  command
```

Where:

address a number between 0 and 31. The VNA will look through all of the GPIB interfaces for an instrument connected to the specified address. If an instrument with that address is not recognized, an error is returned.

command a GPIB command, with or without enclosing quotes. Enclosing quotes are ignored.

Address and command are separated by at least one space.

Commands should be separated by a new line, or carriage return. For example:

```
19 ":init:cont off"
16 init:imm
```

The front-panel **Enter** key inserts a new line into the field.

The number of GPIB commands that can be entered is limited only by the available memory of the VNA.

Handler I/O

Enable Control Enables and disables sending data out the Handler IO Connector (E5080A)

Ports A, B, C, D Sends values to the respective Handler I/O port. Although ports C and D are normally bidirectional, ONLY Output mode is allowed using the Interface Control feature. It cannot read from these, or any other, ports.

Dwell After Command Specifies a wait time, in milliseconds, after all commands to all interfaces are sent. Any positive integer is allowed. This is used to allow all external devices to settle before beginning a measurement. An erratic trace could indicate that more settling time is necessary.

Reset All Sets ALL fields on ALL channels to their default values.

Save and Recall Saves and recalls the contents of this dialog box. If the Interface Control dialog box is populated with settings during an [Instrument State Save](#), the settings are automatically recalled with the Instrument State settings.

Interface control uses an *.xml file type. An example file is stored on the VNA hard drive. You can recall it into the dialog, or you can open and edit it with a word processor, such as Word Pad.

OK Applies the settings and closes the dialog box.

Cancel Does not apply changes that were made, and closes the dialog box.

Last Modified:

29-Sep-2015 First Release



Tutorials

VNA Application Notes

The following links require an **Internet connection**.

Note: Check out the multimedia VNA Demo presentations, including '[Network Analyzer Basics](#)'.

Calibrations

AN1287-11 [Specifying Calibration Standards and Kits for Keysight Vector Network Analyzers \(5989-4840EN\)](#)

PN8510-8A [TRL Calibration for Non-Coaxial Measurements \(5091-3645E\)](#)

[Calibrating Standards for In-Fixture Device Characterization \(White Paper\) \(5989-3245EN\)](#)

[Electronic vs. Mechanical Calibration kits: Calibration methods and accuracy \(White Paper\) \(5988-9477EN\)](#)

[On-Wafer Calibration Using a 4-port, 20 GHz PNA-L Network Analyzer \(N5230A Option 240/245\) \(5989-2287EN\)](#)

ECal

[Keysight Electronic vs. Mechanical Calibration Kits: Calibration Methods and Accuracy \(5988-9477EN\)](#)

[User Characterization: Electronic Calibration Feature Allows Users to Customize to Specific Needs \(5988-9478EN\)](#)

Embedding / De-embedding

[De-embedding and Embedding S-Parameter Networks Using a Vector Network Analyzer \(5980-2784EN\)](#)

Amplifier Measurements

AN1408-7 [Amplifier Linear and Gain Measurements \(5988-8644EN\)](#)

AN1408-8 [Amplifier Swept-Harmonic Measurements \(5988-9473EN\)](#)

AN1408-9 [Amplifier and CW Swept Intermodulation-Distortion Measurements \(5988-9474EN\)](#)

AN1408-10 [High-power measurements using the VNA \(5989-1349EN\)](#)

AN1408-16 [Power-Added Efficiency \(PAE\) 5989-7293EN](#)

AN1408-17 [Making Accurate IMD Measurements with the VNA Network Analyzer \(5989-7265EN\)](#)

AN1408-19 [High Power Amplifier Measurements Using NVNA](#)

Antenna Measurements

[Triggering VNA Microwave Network Analyzers for Antenna Measurements \(5988-9518EN\)](#)

[New Network Analyzer Methodologies in Antenna/RCS Measurements \(5989-1937EN\)](#)

[Pulsed Antenna Measurements Using VNA Network Analyzers \(5989-0221EN\)](#)

[Antenna and RCS Configurations \(White Paper\) \(5989-0220EN\)](#)

[Radar Measurements \(Application Note\) \(5989-7575EN\)](#)

Balanced Measurements (Although the following refer to the ENA, they are also relevant to the VNA.)

[On-wafer Balanced Component Measurement with the Cascade Microtech Probing System \(5988-5886EN\)](#)

[Network De-embedding/Embedding and Balanced Measurement \(5988-4923EN\)](#)

[Backplane Differential Channel Microprobe Characterization in Time and Frequency Domains \(White Paper\) \(5989-3248EN\)](#)

Mixer Measurements

AN1408-1 [Mixer Transmission Measurements Using the Frequency Conversion Application \(5988-8642EN\)](#)

AN1408-2 [Mixer Conversion-Loss and Group Delay Measurement Techniques and Comparisons \(5988-9619EN\)](#)

AN1408-3 [Improving Measurement and Calibration Accuracy Using the Frequency Converter Application \(5988-9642EN\)](#)

AN1408-18 [Measuring Group Delay of Frequency Converters with Embedded Local Oscillators \(5989-7385EN\)](#)

[Comparison of Mixer Characterization using New Vector Characterization Techniques \(5988-7827EN\)](#)

[Novel Method for Vector Mixer Characterization and Mixer Test System Vector Error Correction \(5988-7826EN\)](#)

[Measuring Absolute Group Delay of Multistage Converters Using VNA Microwave Network Analyzers \(5989-0219EN\)](#)

Pulsed Measurements

AN1408-11 [Accurate Pulsed Measurements \(5989-0563EN\)](#)

AN1408-12 [Pulsed-RF S-Parameter Measurements Using Wideband and Narrowband Detection](#)

AN1408-21 [Active-Device Characterization in Pulsed Operation Using the VNA \(5990-7781EN\)](#)

[Pulsed Antenna Measurements Using VNA Network Analyzers \(5989-0221EN\)](#)

Materials Measurements

[Basics of Measuring the Dielectric Properties of Materials \(5989-2589EN\)](#)

[Split Post Dielectric Resonators for Dielectric Measurements of Substrates \(5989-5384EN\)](#)

Other Measurements

AN1287-12 [Time Domain Analysis Using a Network Analyzer \(5989-5723EN\)](#)

AN1408-14 [Using the VNA Series to Analyze Lightwave Components \(5989-3385EN\)](#)

AN1408-15 [Using the VNA for Banded Millimeter-Wave Measurements \(5989-4098EN\)](#)

AN1408-19 [High Power Amplifier Measurements Using NVNA \(5990-5039EN\)](#)

AN1408-20 [High-Accuracy Noise Figure Measurements Using the VNA](#)

[MM-Wave Network Analyzers: Analysis of Cable Length on VNA System Performance \(5989-1941EN\)](#)

[Ultra-Low Impedance Measurements Using 2-Port Measurements \(White Paper\) \(5989-5935EN\)](#)

Modeling

[Utilizing TDR and VNA Data to Develop 4-port Frequency Dependent Models \(White Paper\) \(5989-0638EN\)](#)

[Advanced Measurements and Modeling of Differential Devices \(White Paper\) \(5989-4518EN\)](#)

Automation

AN 1408-13 [Introduction to Application Development using the VNA \(5980-2666EN\)](#)

[Connectivity Advances for Component Manufacturers \(5980-2782EN\)](#)

[The 'Need for Speed' in Component Manufacturing Test \(5980-2783EN\)](#)

Last Modified:

4-Dec-2012 Fixed TD AN

E5080A

10-Oct-2012	Added AN numbers
4-May-2012	Added PAE
20-May-2011	Added new pulse
7-Mar-2011	Added new app notes
22-Oct-2010	Added Noise Figure
14-Apr-2008	Added IMD with VNA.

Connector Care

Proper connector care is critical for accurate and repeatable measurements. The following information will help you preserve the precision and extend the life of your connectors - saving both time and money.

- [Connector Care Quick Reference Guide](#)
- [Connector Cleaning Supplies](#)
- [Safety Reminders](#)
- [About Connectors](#)
- [Gaging Fundamentals](#)
- [Connector Care Procedures](#)

See also mmWave Connector Care at http://na.support.keysight.com/pna/connectorcare/Connector_Care.htm

Preventing Test Port Connector Damage

Handling and Storing Connectors	
Do	Do Not
Keep connectors clean	Touch mating-plane surfaces
Protect connectors with plastic end caps	Set connectors contact-end down
Keep connector temperature same as analyzer	Store connectors loose in box or drawer
Visual Inspection	
Do	Do Not
Inspect connectors with magnifying glass.	Use a connector with a bent or broken center conductor
Look for metal debris, deep scratches or dents	Use a connector with deformed threads
Cleaning Connectors	
Do	Do Not
Clean surfaces first with clean, dry compressed air	Use high pressure air (>60 psi)
Use lint-free swab or brush	Use any abrasives
Use minimum amount of alcohol	Allow alcohol into connector support beads
Clean outer conductor mating surface and threads	Apply lateral force to center conductor

Gaging Connectors

Do

Inspect and clean gage, gage master and device tested

Use correct torque wrench

zero gage before use

Use multiple measurements and keep record of readings

Do Not

Use an out of specification connector

Hold connector gage by the dial

Making Connections

Do

Align connectors first

Rotate only the connector nut

Use correct torque wrench

Do Not

Cross thread the connection

Twist connector body to make connection

Mate different connector types

Connector Care and Cleaning Supplies

Description	Web Site
Swabs	http://www.berkshire.com/swabs.shtml
Lint Free Cloths- Air dusters	http://www.ccrwebstore.com
Isopropyl	http://www.techspray.com
Nitrilite Gloves and Finger Cots	http://www.techni-tool.com

Safety Reminders

When cleaning connectors:

- Always use protective eyewear when using compressed air or nitrogen.
- Keep isopropyl alcohol away from heat, sparks and flame. Use with adequate ventilation. Avoid contact with eyes, skin and clothing.
- Avoid electrostatic discharge (ESD). Wear a grounded wrist strap (having a 1 MΩ series resistor) when cleaning device, cable or test port connectors.
- Cleaning connectors with alcohol shall only be done with the instruments power cord removed, and in a well-ventilated area. Allow all residual alcohol moisture to evaporate, and the fumes to dissipate prior to energizing the instrument.

About Connectors

- [Connector Service Life](#)
- [Connector Grades and Performance](#)

- [Adapters as Connector Savers](#)
- [Connector Mating Plane Surfaces](#)

Connector Service Life

Even though calibration standards, cables, and test set connectors are designed and manufactured to the highest standards, all connectors have a limited service life. This means that connectors can become defective due to wear during normal use. For best results, all connectors should be inspected and maintained to maximize their service life.

Visual Inspection should be performed each time a connection is made. Metal particles from connector threads often find their way onto the mating surface when a connection is made or disconnected. See [Inspection](#) procedure.

Cleaning the dirt and contamination from the connector mating plane surfaces and threads can extend the service life of the connector and improve the quality of your calibration and measurements. See [Cleaning](#) procedure.

Gaging connectors not only provides assurance of proper mechanical tolerances, and thus connector performance, but also indicate situations where the potential for damage to another connector may exist. See [Gaging](#) procedure.

Proper connector care and connection techniques yield:

- Longer Service Life
- Higher Performance
- Better Repeatability

Connector Grades and Performance

The three connector grades (levels of quality) for the popular connector families are listed below. Some specialized types may not have all three grades.

- **Production** grade connectors are the lowest grade and the least expensive. It is the connector grade most commonly used on the typical device under test (DUT). It has the lowest performance of all connectors due to its loose tolerances. This means that production grade connectors should always be carefully inspected before making a connection to the analyzer. Some production grade connectors are not intended to mate with metrology grade connectors.
- **Instrument** grade is the middle grade of connectors. It is mainly used in and with test instruments, most cables and adapters, and some calibration standards. It provides long life with good performance and tighter tolerances. It may have a dielectric supported interface and therefore may not exhibit the excellent match of a metrology grade connector.
- **Metrology** grade connectors have the highest performance and the highest cost of all connector grades. This grade is used on calibration standards, verification standards, and precision adapters. Because it is a high precision connector, it can withstand many connections and disconnections and, thus, has the longest life of all connector grades. This connector grade has the closest material and geometric specifications. Pin diameter and pin depth are very closely specified. Metrology grade uses an air dielectric interface and a slotless female contact which provide the highest performance and traceability.

Note: In general, Metrology grade connectors should not be mated with Production grade connectors.

Adapters as Connector Savers

Make sure to use a high quality (Instrument grade or better) adapter when adapting a different connector type to the analyzer test ports. It is a good idea to use an adapter even when the device under test is the same connector type as the analyzer test ports. In both cases, it will help extend service life, and protect the test ports from damage and costly repair.

The adapter must be fully inspected before connecting it to the analyzer test port and inspected and cleaned frequently thereafter. Because calibration standards are connected to the adapter, the adapter should be the highest quality to provide acceptable RF performance and minimize the effects of mismatch.

Connector Mating Plane Surfaces

An important concept in RF and microwave measurements is the reference plane. For a network analyzer, this is the surface that all measurements are referenced to. At calibration, the reference plane is defined as the plane where the mating plane surfaces of the measurement port and the calibration standards meet. Good connections (and calibrations) depend on perfectly flat contact between connectors at all points on the mating plane surfaces (as shown in the following graphic).

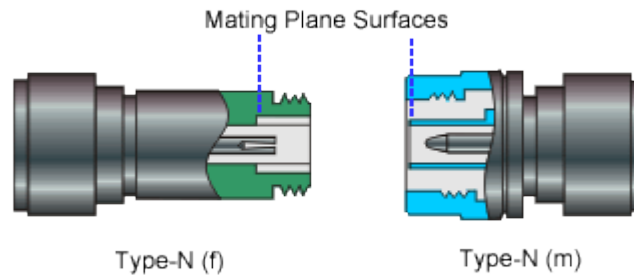

Gaging Fundamentals

Connector gages are important tools used to measure center conductor pin depth in connectors. Connector pin depth, measured in terms of recession or protrusion, is generally the distance between the mating plane and the end of the center conductor, or the shoulder of the center conductor for a stepped male pin.

Typical Connector Gage

RECESSION PROTRUSION

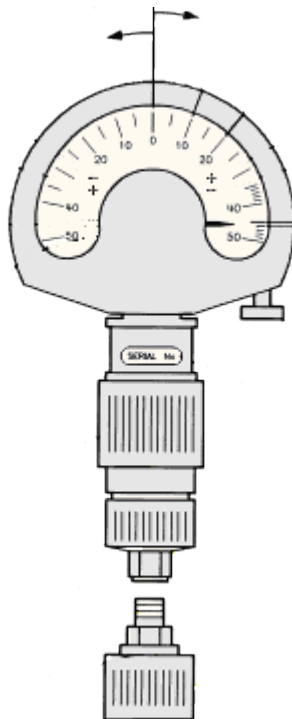

Recession and Protrusion

Pin depth is negative (recession) if the center conductor is recessed below the outer conductor mating plane, usually referred to as the "reference plane". Pin depth is positive (protrusion) if the center conductor projects forward from the connector reference plane.

Pin Depth

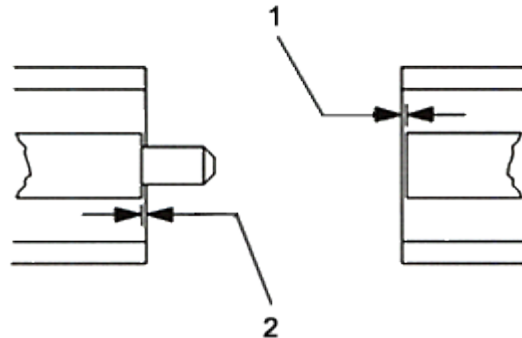

1. Recession of female contact
2. Recession of male pin shoulder

Difference with Type-N Connectors

Type-N connectors have the mating plane of the center conductors offset from the connector reference plane. In this case the zero setting "gage masters" generally offset the nominal distance between the center conductor mating plane and the connector reference plane.

When to Gage Connectors

- Before using a connector or adapter the first time.
- When visual inspection or electrical performance suggests the connector interface may be out of range.
- After every 100 connections, depending on use.

Connector Gage Accuracy

Connector gages (those included with calibration and verification kits), are capable of performing coarse measurements only. This is due to the repeatability uncertainties associated with the measurement. It is important to recognize that test port connectors and calibration standards have mechanical specifications that are extremely precise. Only special gaging processes and electrical testing (performed in a calibration lab) can accurately verify the mechanical characteristics of these devices. The pin depth specifications in the Keysight calibration kit manuals provide a compromise between the pin depth accuracy required, and the accuracy of the gages. The gages shipped with calibration and verification kits allow you to measure connector pin depth and avoid damage from out-of-specification connectors.

Note: Before gaging any connector, the mechanical specifications provided with that connector or device should be checked.

To Gage Connectors

1. Wear a grounded wrist strap (having a 1 M Ω series resistor).
2. Select proper gage for device under test (DUT).
3. Inspect and clean gage, gage master, and DUT.
4. Zero the connector gage.
 - a. While holding gage by the barrel, carefully connect gage master to gage. Finger-tighten connector nut only.
 - b. Use proper torque wrench to make final connection. If needed, use additional wrench to prevent gage master (body) from turning. Gently tap the barrel to settle the gage.

c. The gage pointer should line up exactly with the zero mark on gage. If not, adjust "zero set" knob until gage pointer reads zero. On gages having a dial lock screw and a movable dial, loosen the dial lock screw and move the dial until the gage pointer reads zero. Gages should be zeroed before each set of measurements to make sure zero setting has not changed.

d. Remove gage master.

5. Gage the device under test.

While holding gage by the barrel, carefully connect DUT to gage. Finger-tighten connector nut only.

a. Use proper torque wrench to make final connection and, if needed, use additional wrench to prevent DUT (body) from turning. Gently tap the barrel to settle the gage.

b. Read gage indicator dial for recession or protrusion and compare reading with device specifications.

Caution: If the gage indicates excessive protrusion or recession, the connector should be marked for disposal or sent out for repair.

6. For maximum accuracy, measure the device a minimum of three times and take an average of the readings. After each measurement, rotate the gage a quarter-turn to reduce measurement variations.

7. If there is doubt about measurement accuracy, be sure the temperatures of the parts have stabilized. Then perform the cleaning, zeroing, and measuring procedure again.

Connector Care Procedures

- [Inspecting Connectors](#)
- [Cleaning Connectors](#)
- [Making Connections](#)
- [Using a Torque Wrench](#)
- [Handling and Storing Connectors](#)

To Inspect Connectors

Wear a grounded wrist strap (having a 1 M Ω series resistor).

Use a magnifying glass ($\geq 10X$) and inspect connector for the following:

- Badly worn plating or deep scratches
- Deformed threads
- Metal particles on threads and mating plane surfaces
- Bent, broken, or mis-aligned center conductors
- Poor connector nut rotation

Caution: A damaged or out-of-specification device can destroy a good connector attached to it even on the first connection. Any connector with an obvious defect should be marked for disposal or sent out for repair.

To Clean Connectors

1. Wear a grounded wrist strap (having a 1 M Ω series resistor).
2. Use clean, low-pressure air to remove loose particles from mating plane surfaces and threads. Inspect connector thoroughly. If additional cleaning is required, continue with the following steps.

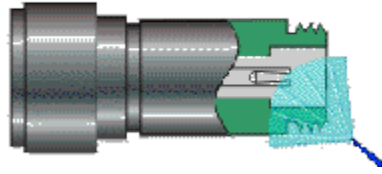

3. Moisten—do not saturate—a lint-free swab with isopropyl alcohol. See [Cleaning Supplies](#) for recommended type.
4. Clean contamination and debris from mating plane surfaces and threads. When cleaning interior surfaces, avoid exerting pressure on center conductor and keep swab fibers from getting trapped in the female center conductor.

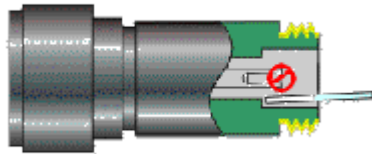

5. Let alcohol evaporate—then use compressed air to blow surfaces clean.
6. Inspect connector. Make sure no particles or residue remains.
7. If defects are still visible after cleaning, the connector itself may be damaged and should not be used. Determine the cause of damage before making further connections.

To Make Connections

1. Wear a grounded wrist strap (having a 1 M Ω series resistor).
2. Inspect, clean, and gage connectors. All connectors must be undamaged, clean, and within mechanical specification.
3. Carefully align center axis of both devices. The center conductor pin—from the male connector—must slip concentrically into the contact finger of the female connector.



4. Carefully push the connectors straight together so they can engage smoothly. Rotate the connector nut (not the device itself) until finger-tight, being careful not to cross the threads.

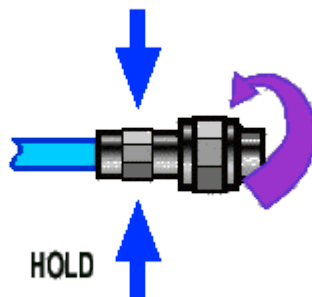

5. Use a torque wrench to make final connection. Tighten until the "break" point of the torque wrench is reached. Do **not** push beyond initial break point. Use additional wrench, if needed, to prevent device body from turning.

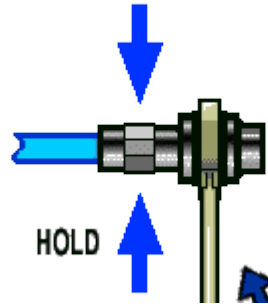

To Separate a Connection

1. Support the devices to avoid any twisting, rocking or bending force on either connector.
2. Use an open-end wrench to prevent the device body from turning.
3. Use another open-end wrench to loosen the connector nut.
4. Complete the disconnection by hand, turning only the connector nut.
5. Pull the connectors straight apart.

To Use a Torque Wrench

1. Make sure torque wrench is set to the correct torque setting.
2. Position torque wrench and a second wrench (to hold device or cable) within 90° of each other before applying force. Make sure to support the devices to avoid putting stress on the connectors.

	HOLD	
CORRECT METHOD	INCORRECT METHOD	(TOO MUCH LIFT)

3. Hold torque wrench lightly at the end of handle—then apply force perpendicular to the torque wrench handle. Tighten until the "break" point of the torque wrench is reached. Do **not** push beyond initial break point.

TORQUING DIRECTION	
STOP WHEN HANDLE BEGINS TO YIELD	

To Handle and Store Connectors

- Install protective end caps when connectors are not in use.
- Never store connectors, airlines, or calibration standards loose in a box. This is a common cause of connector damage.

- Keep connector temperature the same as analyzer. Holding the connector in your hand or cleaning connector with compressed air can significantly change the temperature. Wait for connector temperature to stabilize before using in calibration or measurements.
- Do not touch mating plane surfaces. Natural skin oils and microscopic particles of dirt are difficult to remove from these surfaces.
- Do not set connectors contact-end down on a hard surface. The plating and mating plane surfaces can be damaged if the interface comes in contact with any hard surface.
- Wear a grounded wrist strap and work on a grounded, conductive table mat. This helps protect the analyzer and devices from electrostatic discharge (ESD).



Electrostatic Discharge (ESD) Protection

Protection against electrostatic discharge (ESD) is essential while removing or connecting cables to the network analyzer. Static electricity can build up on your body and can easily damage sensitive internal circuit elements when discharged. Static discharges too small to be felt can cause permanent damage. To prevent damage to the instrument:

- **Always** have a grounded, conductive table mat in front of your test equipment.
- **Always** wear a grounded wrist strap, connected to a grounded conductive table mat, having a 1 M Ω resistor in series with it, when making test setup connections.
- **Always** wear a heel strap when working in an area with a conductive floor. If you are uncertain about the conductivity of your floor, wear a heel strap.
- **Always** ground yourself before you clean, inspect, or make a connection to a static-sensitive device or test port. You can, for example, grasp the grounded outer shell of the test port or cable connector briefly.
- **Always** ground the center conductor of a test cable before making a connection to the analyzer test port or other static-sensitive device. This can be done as follows:
 1. Connect a short (from your calibration kit) to one end of the cable to short the center conductor to the outer conductor.
 2. While wearing a grounded wrist strap, grasp the outer shell of the cable connector.
 3. Connect the other end of the cable to the test port and remove the short from the cable.

See [Analyzer Accessories](#) for ESD part numbers.

Measurements

Absolute Output Power

An absolute output-power measurement displays absolute power versus frequency.

- [What is Absolute Output Power?](#)
- [Why Measure Absolute Output Power?](#)
- [Accuracy Considerations](#)
- [How to Measure Absolute Output Power](#)

[See other Amplifier Parameters topics](#)

What is Absolute Output Power?

An absolute-output power measurement displays the power present at the analyzer's input port. This power is absolute-it is not referenced (ratioed) to the incident or source power. In the log mag format, values associated with the grid's vertical axis are in units of dBm, which is the power measured in reference to 1 mW.

- 0 dBm = 1 mW
- -10 dBm = 100 μ W
- +10 dBm = 10 mW

In the linear mag format, values associated with the grid's vertical axis are in units of watts (W).

Why Measure Absolute Output Power?

Absolute output power is measured when the amplifier's output must be quantified as absolute power rather than a ratioed relative power measurement. For example, during a gain compression measurement, it is typical to also measure absolute output power. This shows the absolute power out of the amplifier where 1-dB compression occurs.

Accuracy Considerations

The output power of the amplifier should be sufficiently attenuated if necessary. Too much output power could:

- Damage the analyzer receiver
- Exceed the input compression level of the analyzer receiver, resulting in inaccurate measurements.

Attenuation of the amplifier's output power can be accomplished using either attenuators or couplers

The amplifier may respond very differently at various temperatures. The tests should be done when the amplifier is at the desired operating temperature.

How to Measure Absolute Power

Do the following to measure absolute output power:

1. Preset the analyzer.
2. Select an unratioed power measurement (receiver B). [Learn how.](#)
3. Set the analyzer's source power to 0 dBm.

4. Select an external attenuator (if needed) so the amplifier's output power will be sufficiently attenuated to avoid causing receiver compression or damage to the analyzer's port-2.
5. Connect the amplifier as shown in the following graphic, and provide the dc bias.

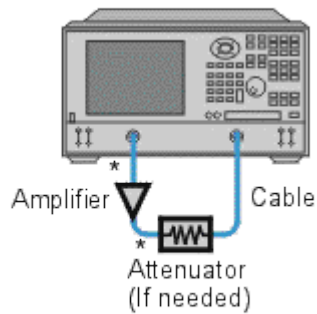

* Direct Connection

6. Select the analyzer settings for your amplifier under test.
7. Remove the amplifier and connect the measurement ports together. Store the data to memory. Be sure to include the attenuator and cables in the test setup if they will be used when measuring the amplifier.
8. Save the instrument state to memory.
9. Reconnect the amplifier.
10. Select the data math function Data/Memory.
11. Scale the displayed measurement for optimum viewing and use a marker to measure the absolute output-power at a desired frequency.
12. Print or save the data to a disk.

Last modified:

25-Jul-2014 First Release



Amplifier Parameters Reference

- [Gain](#)
- [Gain Flatness](#)
- [Reverse Isolation](#)
- [Gain Drift Versus Time](#)
- [Deviation from Linear Phase](#)
- [Group Delay](#)
- [Return Loss \(SWR, \$\rho\$ \)](#)
- [Complex Impedance](#)
- [Gain Compression](#)
- [AM-to-PM Conversion](#)

See Also

- [High-Gain Amplifiers](#)
- [High Power with VNA](#)

Gain

$$\tau = \frac{V_{\text{trans}}}{V_{\text{inc}}}$$

$$\text{Gain (dB)} = -20 \log_{10} |\tau|$$

$$\text{Gain (dB)} = P_{\text{out}} \text{ (dBm)} - P_{\text{in}} \text{ (dBm)}$$

The ratio of the amplifier's output power (delivered to a Z_0 load) to the input power (delivered from a Z_0 source). Z_0 is the [characteristic impedance](#), in this case, 50Ω .

For small signal levels, the output power of the amplifier is proportional to the input power. Small signal gain is the gain in this linear region.

As the input power level increases and the amplifier approaches saturation, the output power reaches a limit and the gain drops. Large signal gain is the gain in this nonlinear region. See [Gain Compression](#).

Gain Flatness

The variation of the gain over the frequency range of the amplifier. See [Small Signal Gain and Flatness](#).

Reverse Isolation

The measure of transmission from output to input. Similar to the gain measurement except the signal stimulus is applied to the output of the amplifier. See [Reverse Isolation](#).

Gain Drift versus Time (temperature, bias)

The maximum variation of gain as a function of time, with all other parameters held constant. Gain drift is also observed with respect to other parameter changes such as temperature, humidity or bias voltage.

Deviation from Linear Phase

The amount of variation from a linear [phase](#) shift. Ideally, the phase shift through an amplifier is a linear function of frequency. See [Deviation from Linear Phase](#).

Group Delay

$$\begin{aligned}\tau_g (\text{sec}) &= - \frac{\Delta \theta}{\Delta \omega} \\ &= - \frac{1}{360} * \frac{\Delta \theta}{\Delta f}\end{aligned}$$

The measure of the transit time through the amplifier as a function of frequency. A perfectly linear phase shift would have a constant rate of change with respect to frequency, yielding a constant group delay.

See [Group Delay](#).

Return Loss (SWR, ρ)

$$\Gamma = \frac{V_{\text{refl}}}{V_{\text{inc}}} = \rho \angle \theta$$

Reflection coefficient = ρ

Return loss (dB) = $-20 \log_{10} \rho$

$$\text{SWR} = \frac{1+\rho}{1-\rho}$$

The measure of the reflection mismatch at the input or output of the amplifier relative to the system Z_0 **characteristic impedance**.

Complex Impedance

$$\begin{aligned}Z &= \frac{1+\Gamma}{1-\Gamma} * Z_0 \\ &= -R + jX\end{aligned}$$

Complex **impedance** (1+G). The amount of reflected energy from an amplifier is directly related to its impedance. Complex impedance consists of both a resistive and a reactive component. It is derived from the characteristic impedance of the system and the reflection coefficient. See [Complex Impedance](#).

Gain Compression

See Gain Compression Application.

AM-to-PM Conversion Coefficient

$$\text{AM/PM} = \frac{\Delta \theta}{\Delta P}$$

The amount of **phase** change generated in the output signal of an amplifier as a result of an amplitude change of the input signal.

The AM-to-PM conversion coefficient is expressed in units of degrees/dB at a given power level (usually $P_{1\text{dB}}$, which is the 1 dB gain compression point). See AM-PM Conversion.



Balanced Measurements

- [What are Balanced Devices?](#)
- [Differential and Common Modes Model](#)
- [Measuring Mixed Mode \(Balanced\) S-Parameters](#)
- [Measuring Imbalance Parameters](#)
- [Measuring CMRR](#)
- [Port Mapping](#)
- [Calibrating Balanced Measurements](#)
- [How the VNA makes Balanced Measurements](#)

Other Measurement Setup Topics

What are Balanced Devices?

Standard **Single-ended devices** generally have one input port and one output port. Signals on the input and output ports are referenced to ground.

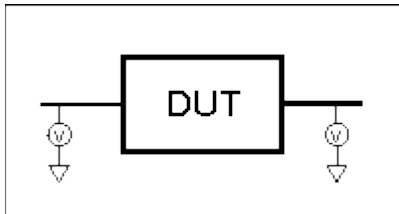

Balanced devices have two pins on either the input, the output, or both. The signal of interest is the difference and average of the two input or output lines, not referenced to ground.

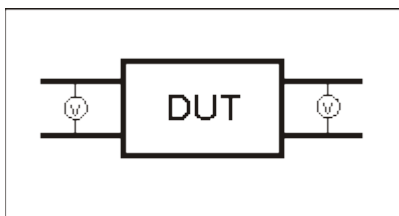

Differential and Common Modes Model

On balanced devices, the signal of interest is the **difference** and **average** of the two input or output lines. In balanced device terminology, these signals are known as the Differential and Common modes.

The following model shows how two signals (A and B) combine to create Differential and Common mode signals:

- **Signal A** is fixed at 1V peak
- **Signal B** is selectable
- **Differential** is calculated as **A minus B**
- **Common** is calculated as the **AVERAGE** of **A** and **B**

Note: Click **Signal B** selections to see various Differential and Common signals.

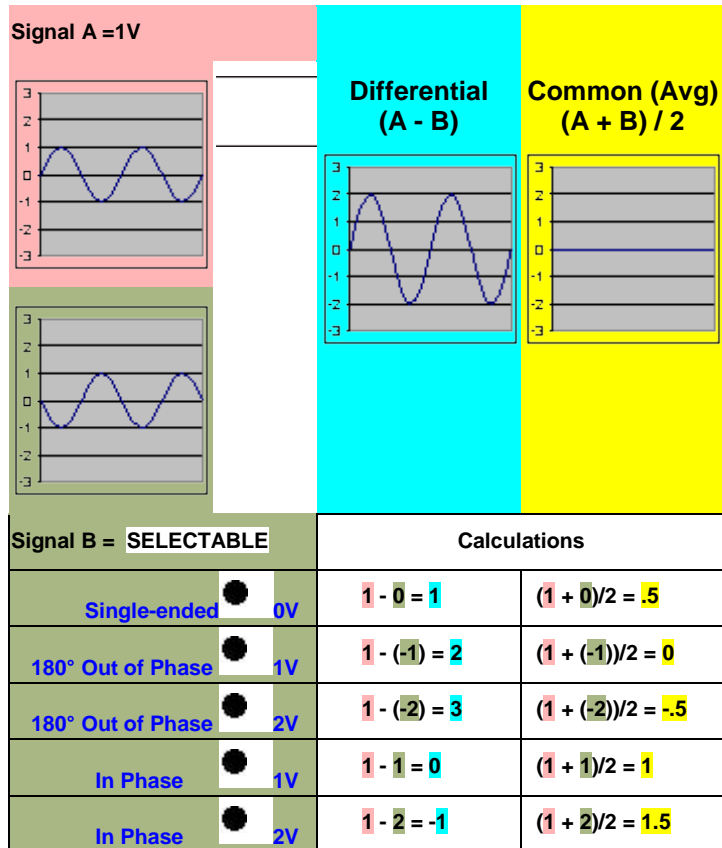
**Notes:**

- Even when Signal B is 0V, like a Single -ended signal, there is still a unique Differential and Common mode representation of the two individual signals.
- The above model does not show a DUT. The difference and average of two signals can be calculated for both the balanced INPUT and balanced OUTPUT of a device.

Measuring Mixed Mode (Balanced) S-Parameters

Mixed mode S-parameters combine traditional S-parameter notation with balanced measurement terminology.

Some balanced devices are designed to amplify the differential component and reject the common component. This allows noise that is common to both inputs to be virtually eliminated from the output. For example, a balanced device may amplify the differential signal by a factor of 5, and attenuate the common signal by a factor of 5. Using traditional S-parameter notation, an S₂₁ is a ratio measurement of the device **Output** / device **Input**. Mixing this with balanced terminology, we could view the amplifier's Differential Output signal / Differential Input signal. To see this parameter on the VNA, we would select an S_{dd21} measurement using the following balanced notation:

Sabxy -

Where

a - device output mode

b - device input mode

(choose from the following for both a and b:)

- **d** - differential
- **c** - common

- **s** - single ended
- x** - device output "logical" port number
y - device input "logical" port number

See Also

[Logical port mapping](#)

Port mapping with External Test Sets

Measuring Imbalance Parameters

Imbalance is a measure of how well two physical ports that make up a balanced port are matched. With a perfectly balanced port, the same amount of energy flows to both ports and the magnitude of the ratio of these ports is 1.

The notation is similar to traditional S-parameters. In the following diagrams, the letters a, b, c, and d are used because any VNA port can be assigned to any logical port using the [port mapping process](#).

For example, in the following single-ended - balanced formula, **S_{ba}** indicates the device output port is logical port b and the input port is logical port a.

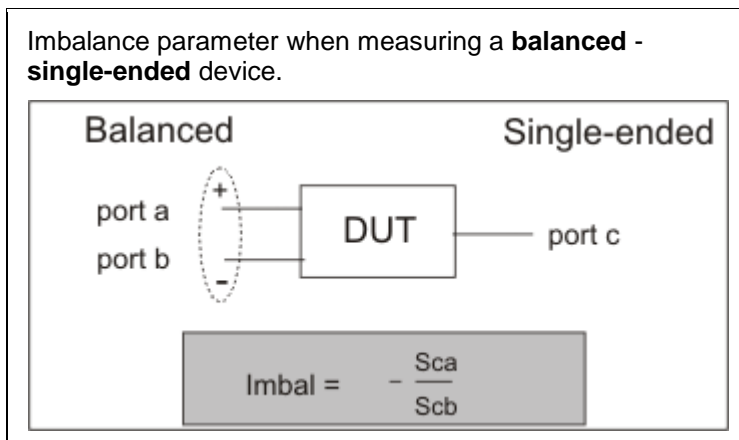
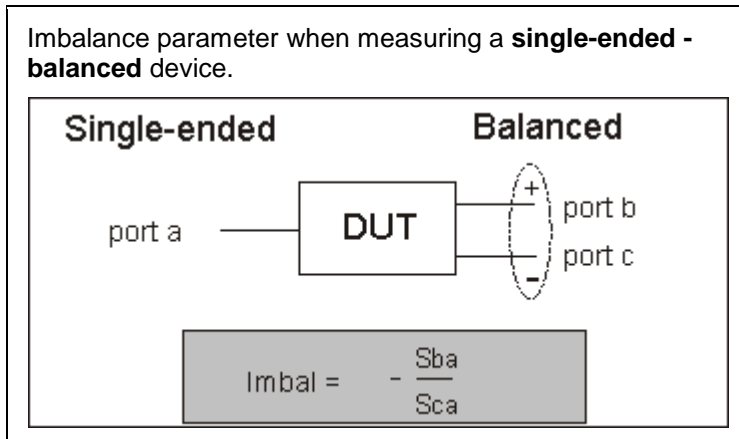

Imbalance1 to 4 parameters when measuring a **balanced - balanced** device.

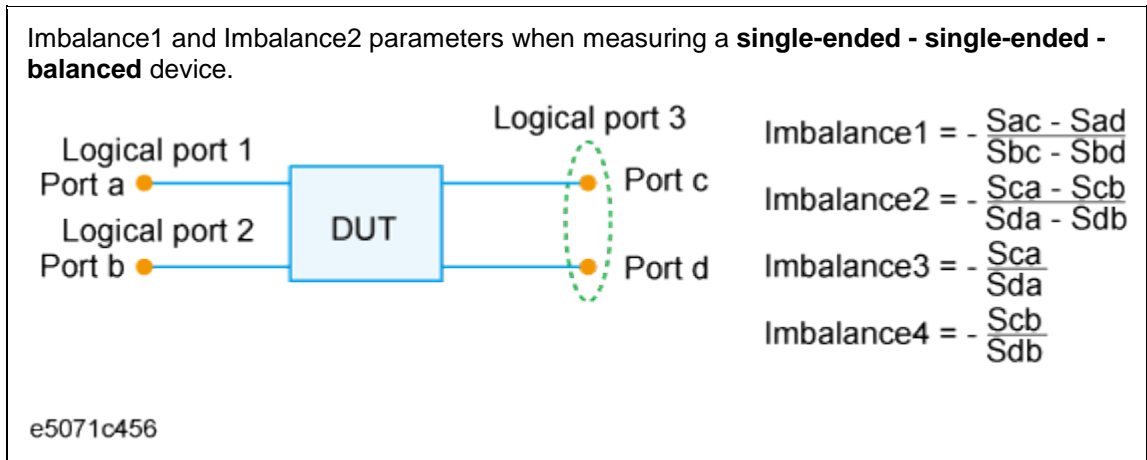
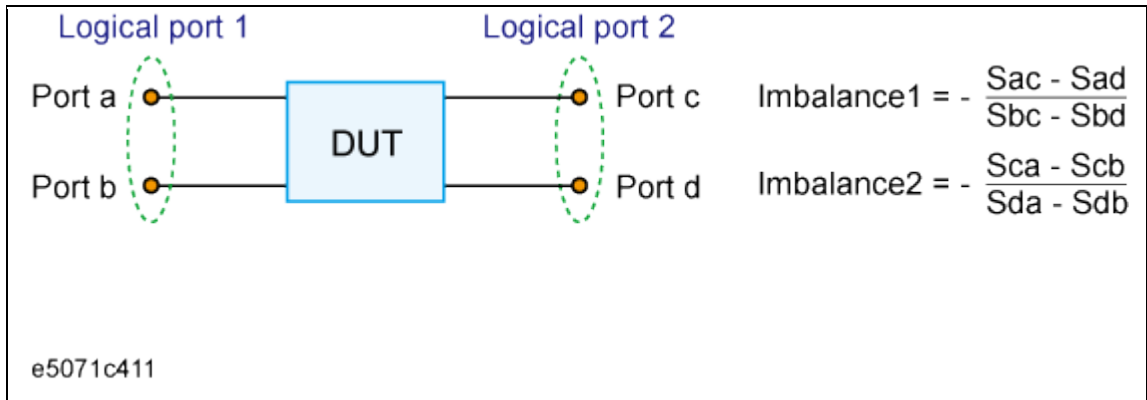

Measuring CMRR (Common Mode Rejection Ratio)

CMRR is a ratio of the transmission characteristic in differential mode over the transmission characteristic in the common mode of the balanced port as the measurement parameter. A high value indicates more rejection of common mode, which is desirable in a device that transmits information in the differential portion of the signal. The table below shows the CMRR parameter you can select when measuring each balanced device.

Single-ended - balanced device	$\frac{S_{ds21}}{S_{cs21}}$	and	$\frac{S_{sd12}}{S_{sc12}}$
Balanced - single-ended device	$\frac{S_{sd21}}{S_{sc21}}$	and	$\frac{S_{ds12}}{S_{cs12}}$
Balanced - balanced device	$\frac{S_{dd21}}{S_{cc21}}$		
Single-ended - single-ended - balanced device	$\frac{S_{ds31}}{S_{cs31}}$	and	$\frac{S_{ds32}}{S_{cs32}}$

Device Topology and Port Mapping

As we have seen on balanced inputs and outputs, the signal of interest is the difference or average of two BALANCED input or BALANCED output lines. It is also possible to have single-ended ports AND

balanced ports on the same device. The two balanced input or output lines are referred to as a single "logical" port.

When configuring a balanced measurement on the VNA, select a device 'topology'. Then map each VNA test port to the DUT ports. The VNA assigns "logical ports". [See how to set device topology in the VNA.](#)

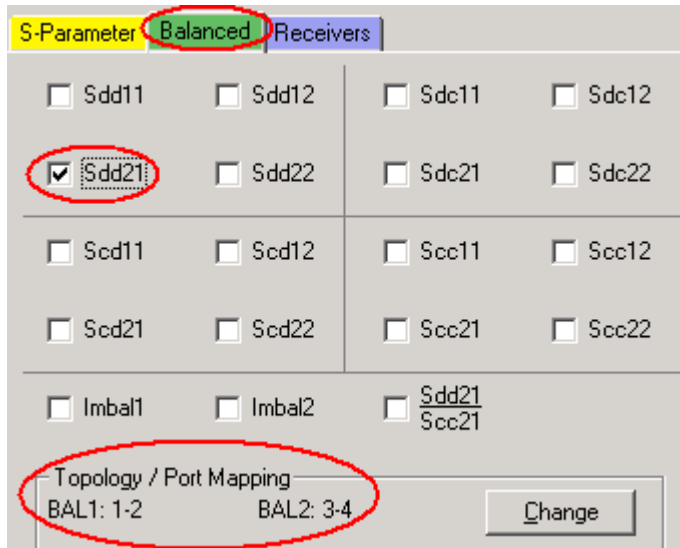

The following device topologies can be measured by a 4-port VNA.

- **Balanced / Balanced**
(2 logical ports - 4 physical ports)

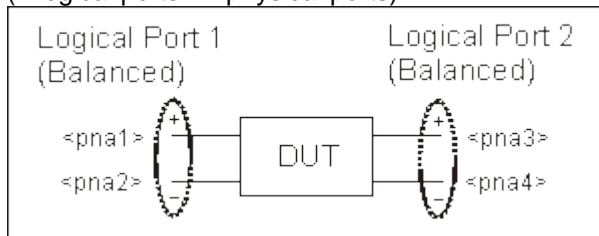

- **Single-ended / Balanced**
(2 logical ports - 3 physical ports)

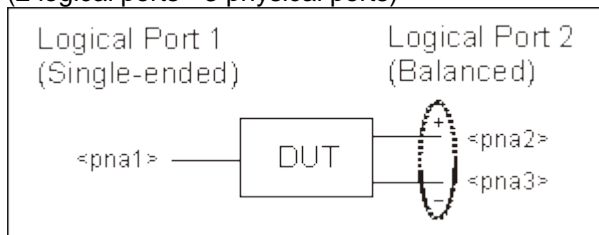

- **Balanced / Single-ended**
(2 logical ports - 3 physical ports)

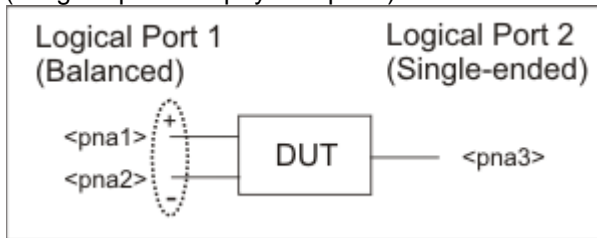

- **Single-ended - Single-ended / Balanced**
(3 logical ports - 4 physical ports)

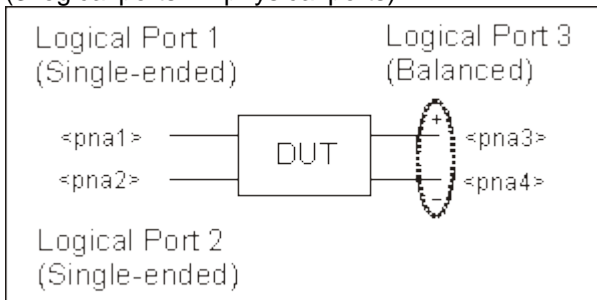

These topologies can be used in the reverse (\Leftarrow) direction to measure:

- **Balanced / Single-ended** topology
- **Balanced / Single-ended - Single-ended** topology

For example, to measure a **Balanced / Single-ended** topology, measure the S12 (reverse direction) of a **Single-ended / Balanced** topology.

Calibrating Balanced Measurements

Balanced measurements are calibrated in the same manner as single-ended (standard) measurements. However, for highest accuracy, you must choose Thru paths so that each **transmission path** of the balanced measurement is represented. For a Balanced/Balanced topology, this means that FOUR Thru connections should be made.

For example (see following image):

- Balanced Port 1 is ports 1 and 3
- Balanced Port 2 is ports 2 and 4
- Thru paths to be calibrated should be: 12, 14, 32, 34.
- Paths 13, and 24 are less important.



To select Thru paths:

1. From SmartCal, on the Select DUT Connectors and Cal Kits page, check **Modify Cal**.
2. Click **Next** to see the following Cal Wizard page:

Modify Cal				
	1st Port	2nd Port	Thru Cal Method	
Thru #1	1	2	Unknown Thru	Cal Type/Std...
Thru #2	1	4	Unknown Thru	Cal Type/Std...
Thru #3	3	4	Unknown Thru	Cal Type/Std...
Thru #4	2	3	Unknown Thru	Cal Type/Std...

How the VNA makes Balanced Measurements

When using standard Balanced measurements, the VNA does not provide true balanced measurements by stimulating both balanced inputs together and measuring both outputs relative to one another. Instead, the VNA makes only Single-ended measurements. On a Balanced/ Balanced device, it stimulates each input and measures each output individually. From the output data, the VNA calculates the Differential and Common outputs from the DUT using the same math formulas as the above model. However, all measurements and calculations on the VNA are performed in frequency domain using complex (magnitude and phase) data. The Balanced S-parameter display data is then calculated from the Differential and Common inputs and outputs.

I

Last Modified:

29-Sep-2015 First Release



Complex Impedance

When making an S_{11} or S_{22} measurement of your device under test, you can view complex-impedance data such as series resistance and reactance as well as **phase** and magnitude information. Complex impedance data can be viewed using either the Smith Chart format or the Polar format.

- [What Is Complex Impedance?](#)
- [Accuracy Considerations](#)
- [How to Measure Complex Impedance](#)

What Is Complex Impedance?

Complex-impedance data is information that can be determined from an S_{11} or S_{22} measurement of your device under test, such as:

- Resistance
- Reactance
- Phase
- Magnitude

The amount of power reflected from a device is directly related to the impedances of both the device and the measuring system. For example, the value of the complex reflection coefficient (Γ) is equal to 0 only when the device impedance and the system impedance are exactly the same (i.e. maximum power is transferred from the source to the **load**). Every value for Γ corresponds uniquely to a complex device impedance (as a function of frequency), according to the equation:

$$Z_L = [(1 + \Gamma) / (1 - \Gamma)] \times Z_0$$

where Z_L is your test device impedance and Z_0 is the measuring system's **characteristic impedance**.

Complex Impedance is best viewed using either [Polar](#) or [Smith Chart](#) format.

Accuracy Considerations

- The Smith chart is most easily understood when used with a full scale value of 1.0.
- For greater accuracy when using markers in the Smith chart or polar formats, activate the discrete marker mode.
- The uncertainty of reflection measurements is affected by:
 - **Directivity**
 - Reflection tracking
 - Source match
 - **Load_match** (with 2-port devices)

With a 2-port **calibration**, the effects of these factors are reduced. A 1-port calibration provides the same accuracy if the output of the device is well terminated. Refer to the graphic below for the following discussion.

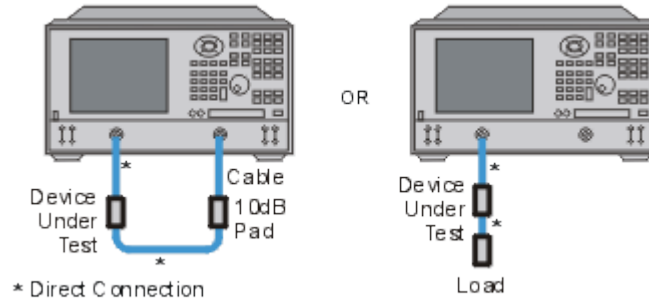

- If you connect the device between both analyzer ports, it is recommended that you use a 10 dB pad on the output of the device to improve measurement accuracy. This is not necessary if you use a 2-port calibration since it corrects for load match.
- If you connect a two-port device to only one analyzer port, it is recommended that you use a high-quality **load** (such as a calibration standard) on the output of the device.

How to Measure Complex Impedance

1. Connect the device as shown in the previous graphic.
2. Preset the analyzer.
3. Set up, calibrate, and perform an S11 or S22 measurement.
4. View impedance data:
 - a. Select the Smith Chart format.
 - b. Scale the displayed measurement for optimum viewing.
 - c. Position the marker to read the resistive and reactive components of the complex impedance at any point along the trace.
 - d. Print the data or save it to a disk.
5. View the magnitude and **phase** of the reflection coefficient:
 - a. Select the Smith chart format or the Polar format.
 - b. Select either Lin Marker or Log Marker formats.
 - c. Scale the displayed measurement for optimum viewing.
 - d. Position the marker to read the frequency, magnitude, and phase of the reflection coefficient (Γ) at any point along the trace.
 - e. Print the data or save it to a disk.



Comparing the VNA "Delay" Functions

The VNA has three Delay functions which are similar but are used in different ways.

1. **Group Delay format** is used to display the Group Delay of a network. Group Delay is defined as:

$$-d(\phi)/d(\omega) \text{ -- where } \phi \text{ is radian angle, and } \omega \text{ is radian frequency.}$$

Since it is defined by a derivative, the value must be determined from an analytic function. However, the VNA makes discrete measurements, so we approximate the group delay by taking the finite difference:

$$-(1/360) * \Delta(\phi) / \Delta(f) \text{ -- where } \phi \text{ is degree angle and } f \text{ is frequency in Hz. The } 1/360 \text{ does the proper conversion of degrees to radians and Hz frequency to radian frequency.}$$

From this we can see that, if the phase response of a network varies with frequency, then the Group Delay must vary as well. In fact, many filters are specified by the variation of their Group Delay.

If we measure the phase response of a lossless cable, it should be a straight line. But, of course, nothing is perfect. The phase response will have a small amount of noise. This is due to trace noise of the VNA, and the loss with real cables or transmission lines, which causes a small amount of non-linear phase change with frequency. So, if we look at the Group Delay of a cable, we will see a small amount of variation. Also, if the frequency spacing is small enough when you make the measurement, the $\Delta(f)$ in the denominator becomes very small, so the delay can have wide swings with just a little noise.

To overcome this issue, we sometimes add smoothing to a phase trace, which widens the effective $\Delta(f)$, called the aperture, and provides a less noisy Group Delay response. The Group Delay of a device is only valid for a given frequency aperture. [Learn more about Group Delay.](#)

2. **Electrical Delay** function. On many filters, the passband response is specified for a maximum value of "Deviation from Linear Phase". When looking at the passband of a multi-pole filter, one sees the phase changing very rapidly. This makes it difficult to determine the linearity of the phase response. The Electrical Delay function subtracts out a "LINEAR PHASE" equivalent to the delay time value computed as above. When you use this function, you dial in the Linear Delay such that a CONSTANT PHASE SLOPE is removed from the phase trace, until the phase trace is mostly flat. The remaining variation is the deviation from linear phase.

To make this task a little less tedious, the VNA has a marker function called [Marker ==> Delay](#). This function computes the Group Delay value at the marker position, using a 20% smoothing aperture, then changes the Electrical Delay value to this value. Obviously, if the phase trace is not perfectly linear, moving the marker and recomputing the delay will result in different values. The phase slope added by the electrical delay function applies only to the current measurement. That is, each measurement (S11, S22, S12, S21) can have its own value of electrical delay. [Learn more about Deviation from Linear Phase.](#)

3. **Port Extension** is a function that is similar to calibration. It applies to all the traces in a given channel. It compensates for the phase response change that occurs when the calibration reference plane is not the same as the measurement plane of the device.

Let's look at an example of a DUT that is mounted on a PCB fixture with SMA connectors. We can easily calibrate at the SMA connectors. But if we add the fixture to measure the board-mounted device, the apparent phase of the DUT is changed by the phase of the PCB fixture. We use port extensions to add a LINEAR PHASE (constant delay) to the calibration routines to shift the phase reference plane to that of the DUT. This is ONLY valid if the fixture consists of a transmission line with linear phase response, and this limitation is usually met in practice. The main reason that it is NOT met is that there is mismatch at the SMA-to-PCB interface. This mismatch was not removed with the error correction because it occurs AFTER the SMA connector. Ripple can be seen on the display as signals bounce back and forth between the mismatch and the DUT. If the DUT is well matched, the ripple effect is very small. However, when we use Automatic Port Extension (APE), and we leave the fixture open (the DUT removed), the reflection is large and we see larger ripples. That is why APE uses a curve fitting process to remove the effects of the

ripple. For best effect, the wider the IF Bandwidth, the better we can "smooth-out" the ripples with curve fitting. Still, we are fitting a LINEAR PHASE SLOPE to the phase response, and thus we use only a single Port Extension Delay value to represent the phase slope.

The method used by older VNAs to get this same functionality was to add a mechanical line stretcher to the reference channel, which removed a fixed delay amount from the port. Port extensions give 1x the delay for transmission at each port, and 2x the delay for reflection, so it differs somewhat from Electrical Delay above, in that the math function depends upon the measurement being made. The signal passes twice through the fixture for reflection (out and back), but only once for each port on transmission. For S21, the phase slope added is the sum of the port 1 and port 2 Port Extension Delay values.

The "User Range" APE function is used in cases where a fixture has limited bandwidth, perhaps due to tuning elements or bias elements. In this case, the model of constant delay for the fixture over the whole bandwidth is not valid, so a narrower "User Range" of frequencies can be selected to compute the delay. Since the aperture is smaller, there is more uncertainty in the delay computation for port extension. Also, for those who had been using the [Marker =>> Delay](#) function to estimate the delay, we added the "Active Marker" selection to APE, which works exactly the same as Marker->Delay. [Learn more about Automatic Port Extensions.](#)

Deviation from Linear Phase

Deviation from linear phase is a measure of phase distortion. The electrical delay feature of the analyzer is used to remove the linear portion of the phase shift from the measurement. This results in a high-resolution display of the non-linear portion of the phase shift (deviation from linear phase).

- [What Is Linear Phase Shift?](#)
- [What Is Deviation from Linear Phase?](#)
- [Why Measure Deviation from Linear Phase?](#)
- [Using Electrical Delay](#)
- [Accuracy Considerations](#)

See also [Comparing the VNA Delay Functions](#)

See other Tutorials

What Is Linear Phase Shift?

Phase shift occurs because the wavelengths that occupy the electrical length of the device get shorter as the frequency of the incident signal increases. *Linear* phase-shift occurs when the phase response of a device is linearly proportional to frequency. Displayed on the analyzer, the phase-versus-frequency measurement trace of this ideal linear phase shift is a straight line. The slope is proportional to the electrical length of the device. Linear phase shift is necessary (along with a flat magnitude response) for distortionless transmission of signals.

What Is Deviation from Linear Phase?

In actual practice, many electrical or electronic devices will delay some frequencies more than others, creating non-linear phase-shift (distortion in signals consisting of multiple-frequency components). Measuring deviation from linear phase is a way to quantify this non-linear phase shift.

Since it is only the deviation from linear phase which causes phase distortion, it is desirable to remove the linear portion of the phase response from the measurement. This can be accomplished by using the electrical delay feature of the analyzer to mathematically cancel the electrical length of the device under test. What remains is the deviation from linear phase, or phase distortion.

Why Measure Deviation from Linear Phase?

The deviation from linear phase measurement accomplishes the following:

- Presents data in units of phase rather than units of seconds (group delay). For devices that pass modulated signals, units of phase may be most practical.
- Provides a less noisy measurement than a [group delay](#) measurement.

Using Electrical Delay

The electrical delay feature is the electronic version of the mechanical "line stretcher" of earlier analyzers. This feature does the following:

- Simulates a variable-length lossless transmission line, which is effectively added to or removed from the reference signal path.
- Compensates for the electrical length of the device under test.
- Flattens the measurement trace on the analyzer's display. This allows the trace to be viewed at high resolution in order to see the details of the phase nonlinearity.

- Provides a convenient method to view the deviation from linear phase of the device under test. See the following graphic.

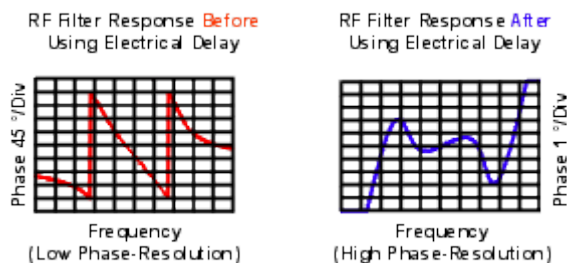

[Learn how to set Electrical Delay.](#)

Accuracy Considerations

The frequency response of the test setup is the dominant error in a deviation from linear phase measurement. To reduce this error, perform a 2-port measurement calibration.

How to Measure Deviation from Linear Phase:

1. Preset the analyzer.
2. If your device under test is an amplifier, it may be necessary to adjust the analyzer's source power:
 - Set the analyzer's source power to be in the linear region of the amplifier's output response (typically 10-dB below the 1-dB compression point).
 - Select an external attenuator (if needed) so the amplifier's output power will be sufficiently attenuated to avoid causing receiver compression or damage to the analyzer's port 2.
3. Connect the device under test as shown in the following graphic.

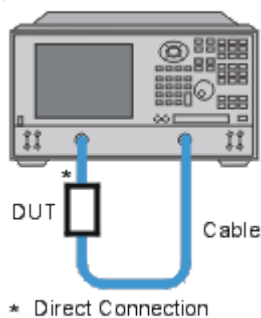

3. Select an S21 measurement.
4. Select the settings for your device under test, including the following:
 - [Format](#): phase
 - [Scale](#): autoscale
5. Remove the device and perform a calibration.
6. Reconnect the device.
7. Scale the displayed measurement for optimum viewing.
8. [Create a marker](#) in the middle of the trace.
9. Press the **>Delay** key to invoke the [Marker to Electrical Delay](#) function. This flattens the phase trace.
10. If desired, on the **Scale** menu, click [Electrical Delay](#) to fine-tune the flatness of the phase trace.

E5080A

11. Use the markers to measure the maximum peak-to-peak deviation from linear phase.
12. Print the data or save it to a disk.



Small Signal Gain and Flatness

Small signal gain is the gain in the amplifier's linear region of operation. This is typically measured at a constant input power over a swept frequency. Gain **flatness** is the measure of the variation of gain over a specified frequency range.

- [What Is Gain?](#)
- [What Is Flatness?](#)
- [Why Measure Gain and Flatness?](#)
- [Accuracy Considerations](#)
- [How to Measure Gain and Flatness](#)

[See other Amplifier Parameter topics](#)

What Is Gain?

RF amplifier gain is defined as the difference in power between the amplifier output signal and the input signal. It is assumed that both input and output impedances of the amplifier are the same as the **characteristic impedance** of the system.

- Gain is called S_{21} using S-parameter terminology
- Gain is expressed in dB—a logarithmic ratio of the output power relative to the input power.
- Gain can be calculated by subtracting the input from the output levels when both are expressed in dBm, which is power relative to 1 milliwatt.
- Amplifier gain is most commonly specified as a minimum value over a specified frequency range. Some amplifiers specify both minimum and maximum gain, to ensure that subsequent stages in a system are not under or over driven.

What Is Flatness?

Flatness specifies how much the amplifier's gain can vary over the specified frequency range. Variations in the flatness of the amplifier's gain can cause distortion of signals passing through the amplifier.

Why Measure Small-Signal Gain and Flatness?

Deviations in gain over the **bandwidth** of interest will induce distortion in the transmitted signal because frequency components are not amplified equally. Small-signal gain allows you to quantify the amplifier's gain at a particular frequency in a 50-ohm system. Flatness allows you to view the deviations in the amplifier's gain over a specified frequency range in a 50-ohm system.

Accuracy Considerations

- The amplifier may respond very differently at various temperatures. The tests should be done when the amplifier is at the desired operating temperature.
- The output power of the amplifier should be sufficiently attenuated if necessary. Too much output power could:
 - damage the analyzer receiver
 - exceed the input compression level of the analyzer receiver, resulting in inaccurate measurements.

Attenuation of the amplifier's output power can be accomplished using:

- o attenuators
- o couplers

The frequency-response effects and mismatches of the attenuators and couplers must be accounted for during **calibration** since they are part of the test system. Proper error-correction techniques can reduce these effects.

- The **frequency response** is the dominant error in a small-signal gain and flatness measurement setup. Performing a thru-response measurement calibration significantly reduces this error. For greater accuracy, perform a 2-port measurement calibration.
- Reducing IF bandwidth or using **averaging** improves measurement **dynamic range** and accuracy, at the expense of measurement speed.

How to Measure Gain and Flatness

1. Preset the analyzer.
2. Select an S21 measurement parameter.
3. Set the analyzer's source power to be in the linear region of the amplifier's output response (typically 10-dB below the 1-dB compression point).
4. Select an external attenuator (if needed) so the amplifier's output power will be sufficiently attenuated to avoid causing receiver compression or damage to the analyzer's port-2.

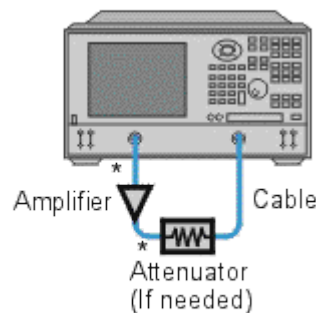

* Direct Connection

5. Connect the amplifier as shown in the following graphic, and provide the dc bias.
6. Select the analyzer settings for your amplifier under test.
7. Remove the amplifier and perform a measurement **calibration**. Be sure to include the attenuator and cables in the calibration setup if they will be used when measuring the amplifier.
8. Save the instrument-state to memory.
9. Reconnect the amplifier.
10. Scale the displayed measurement for optimum viewing and use a marker to measure the small signal gain at a desired frequency.
11. Measure the gain **flatness** over a frequency range by using markers to view the peak-to-peak ripple.
12. Print or save the data to a disk.
13. This type of measurement can be automated.



Group Delay

Group delay is a measure of phase distortion. Group delay is the actual transit time of a signal through a device under test as a function of frequency. When specifying group delay, it is important to specify the aperture used for the measurement.

- [What is Group Delay?](#)
- [Group Delay versus Deviation from Linear Phase](#)
- [What Is Aperture?](#)
- [Accuracy Considerations](#)
- [How to Measure Group Delay](#)

See also [Comparing the VNA Delay Functions.](#)

[See other Amplifier Parameter topics](#)

What Is Group Delay?

Group delay is:

- A measure of device phase distortion.
- The transit time of a signal through a device versus frequency.
- The derivative of the device's phase characteristic with respect to frequency.

Refer to the graphic below for the following discussion:

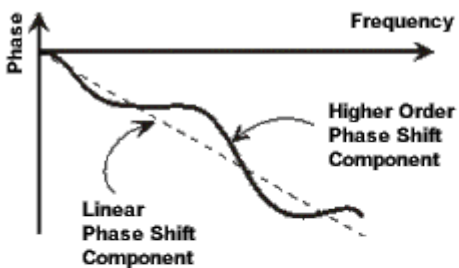

$$\begin{aligned} \text{Group Delay} = t_g &= \frac{-d\phi}{d\omega} && \phi \text{ in Radians} \\ &&& \omega \text{ in Radians/Sec} \\ &= \frac{-1}{360^\circ} \cdot \frac{d\Theta}{df} && \Theta \text{ in Degrees} \\ &&& f \text{ in Hz } (\omega = 2\pi f) \end{aligned}$$

The phase characteristic of a device typically consists of both linear and higher order (deviations from linear) phase-shift components.

Linear phase-shift component:	Higher-order phase-shift component:
Represents average signal transit time.	Represents variations in transit time for different frequencies.
Attributed to electrical length of test device.	Source of signal distortion.

Refer to the graphic below for the following discussion:

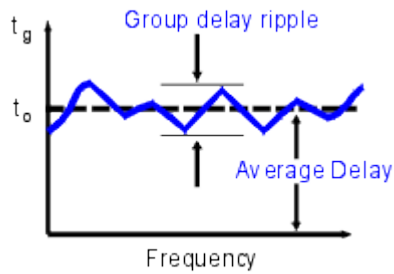

In a group delay measurement:

- The linear phase shift component is converted to a constant value (representing the average delay).
- The higher order phase shift component is transformed into deviations from constant group delay (or group delay ripple).
- The deviations in group delay cause signal distortion, just as deviations from linear phase cause distortion.
- The measurement trace depicts the amount of time it takes for each frequency to travel through the device under test.

Refer to the following equation for this discussion on how the VNA computes group delay:

$$\text{Group Delay} = t_g = \frac{-d\phi}{d\omega}$$

$$= \frac{-1}{360^\circ} \cdot \frac{d\Theta}{df}$$

ϕ in Radians
 ω in Radians/Sec
 Θ in Degrees
 f in Hz ($\omega = 2 \pi f$)

- Phase data is used to find the phase change ($-d\phi$).
- A specified frequency aperture is used to find the frequency change ($d\omega$).
- Using the two values above, an approximation is calculated for the rate of change of phase with frequency.
- This approximation represents group delay in seconds (assuming linear phase change over the specified frequency aperture).

Group Delay versus Deviation from Linear Phase

Group delay is often a more accurate indication of phase distortion than [Deviation from Linear Phase](#).

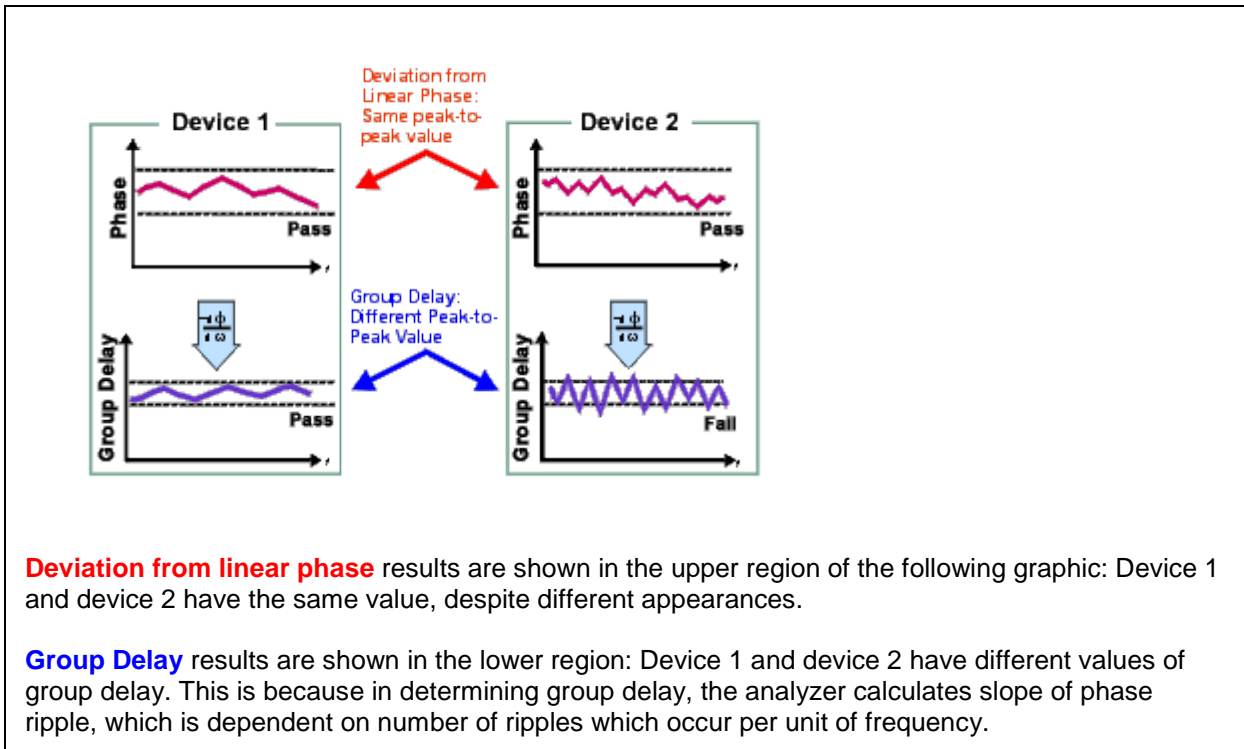

What Is Aperture?

During a group delay measurement, the VNA measures the phase at two closely spaced frequencies and then computes the phase slope. The frequency interval (frequency delta) between the two phase measurement points is called the aperture. Changing the aperture can result in different values of group delay. The computed slope ($-\Delta\phi / \Delta f$) varies as the aperture is increased. This is why when you are comparing group delay data, you must know the aperture that was used to make the measurements.

Refer to the graphic below for the following discussion:

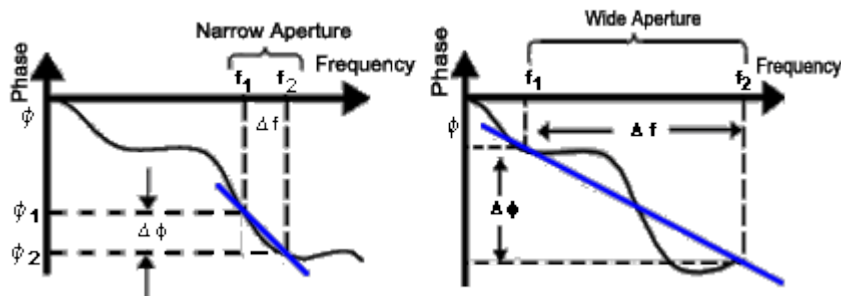

Narrow aperture:	Wide aperture:
Provides more detail in phase linearity.	Provides less detail in phase linearity because some phase response averaged-out or not measured.
Makes measurement susceptible to noise (smaller signal-to-noise ratio) and VNA phase detector resolution.	Makes measurement less susceptible to noise (larger signal-to-noise ratio).

Group delay measurements can be made using the following [sweep types](#):

- Linear frequency
- List frequency sweep segment - The group delay aperture varies depending on the frequency spacing and point density. Therefore the aperture is not constant in segment sweep. In segment sweep, extra frequency points can be defined to ensure the desired aperture.

How to set Group Delay Aperture

Using **Hardkey/SoftTab/Softkey**

1. Press **Format** > **Format 1** > **Group Delay Aperture...**

or

1. Press **Ave** > **Delay Aperture**.
2. Press the desired softkey and set the value.

◀ Programming Commands ▶

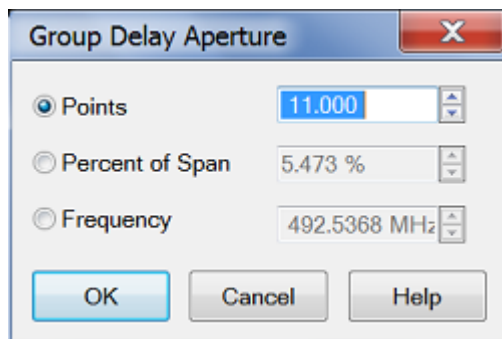

Ave > **Group Delay** / **Group Delay Aperture** dialog box help

Although the Group Delay Aperture is defined as the difference in frequency between two data points (see [What Is Aperture?](#)), the group delay calculation can be averaged over many adjacent data points, similar to the VNA smoothing feature. The number of adjacent data points can be set using any of the following methods:

Note: You can change the default Group Delay Aperture to two points using a VNA Preference. [Learn how.](#)

Points Number of adjacent data points to average. Default setting is 11 points. Choose a value between 2 and the current number of points in the channel.

Percent of Span The data points within this percentage of the current frequency span are averaged. Choose a value between (2 points / current number of points) and 100 percent. The span must contain at least two data points.

Frequency The data points within this frequency range are averaged. The frequency range must contain at least two data points.

When the frequency span or number of points is reduced so that the current Group Delay Aperture is NOT attainable, the Aperture is adjusted to the new frequency span or number of points.

OK Applies setting changes and closes the dialog box.

Cancel Closes the dialog. Setting changes are NOT applied.

Accuracy Considerations

It is important to keep the phase difference between two adjacent measurement points less than 180° (see the following graphic). Otherwise, incorrect phase and delay information may result. Undersampling may occur when measuring devices with long electrical length. You can verify that the phase difference measured between two adjacent points is less than 180° by adjusting the following settings until the measurement trace no longer changes:

- Increase the number of points
- Narrow the frequency span

Electrical delay may also be used to compensate for this effect.

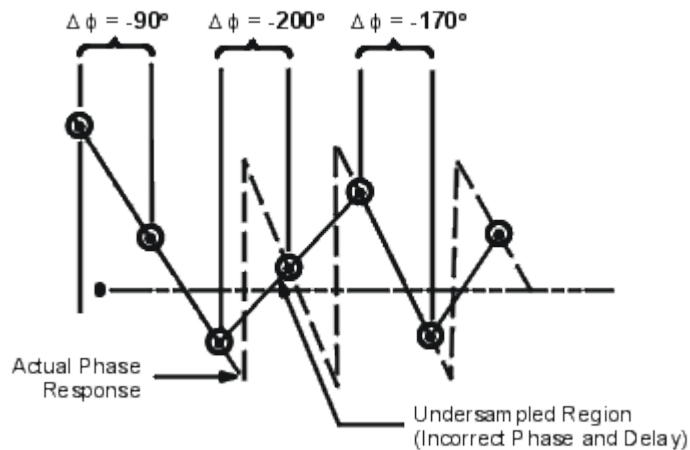

The frequency response is the dominant error in a group delay test setup. Performing a thru-response measurement calibration significantly reduces this error. For greater accuracy, perform a 2-port measurement calibration.

Particularly for an amplifier, the response may vary differently at various temperatures. The tests should be done when the amplifier is at the desired operating temperature.

How to Measure Group Delay

1. Preset the analyzer.
2. If your DUT is an amplifier, it may be necessary to adjust the VNA source power:
 - Set the source power to be in the linear region of the amplifier's output response, typically 10 dB below the 1 dB compression point.
 - If needed, use an external attenuator so the amplifier output power will be sufficiently attenuated to avoid causing receiver compression or damage to the VNA port 2.
3. Connect the DUT as shown in the following graphic.

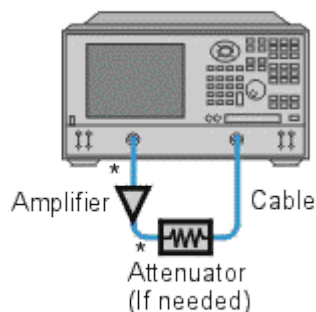

* Direct Connection

4. Select an S21 measurement.

5. Select the settings for your DUT:
 - frequency range
 - number of measurement points.
 - format: delay
 - scale: autoscale
6. Remove the DUT and perform a measurement calibration.
7. Reconnect the DUT.
8. Scale the displayed measurement for optimum viewing.
9. Use the Group Delay Aperture setting to increase the aperture, reducing noise on the trace while maintaining meaningful detail.
10. Use the markers to measure group delay (expressed in seconds) at a particular frequency of interest.
11. Print the data or save it to a disk.

Phase Measurements

Knowledge of both magnitude and phase characteristics is needed for successful higher-level component integration.

- [What are Phase Measurements?](#)
- [Why Measure Phase?](#)
- [Using the Analyzer's Phase Format](#)
- [Types of Phase Measurements](#)

See other Tutorials

What are Phase Measurements?

Phase measurements are made using S-parameters, just like amplitude measurements. A phase measurement is a relative (ratio) measurement and not an absolute measurement. Phase measurements compare the phase of the signal going into a device (the incident signal) to the phase of the device's response signal. The response signal can be either reflected or transmitted. Assuming an accurate [calibration](#) has been performed, the difference in phase between the two signals (known as phase shift) is a result of the electrical characteristics of the device under test.

The following graphic shows the phase shift (in time or degrees) between an incident signal and a transmitted signal (as might be seen on an oscilloscope display).

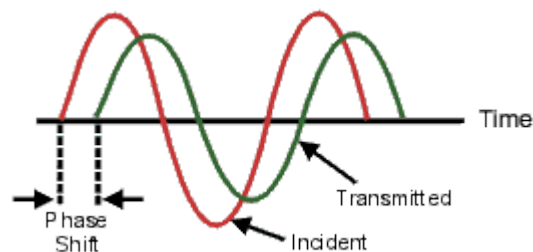

Why Measure Phase?

Measuring [phase](#) is a critical element of network analysis. The following graphic lists five reasons for measuring both magnitude and phase.

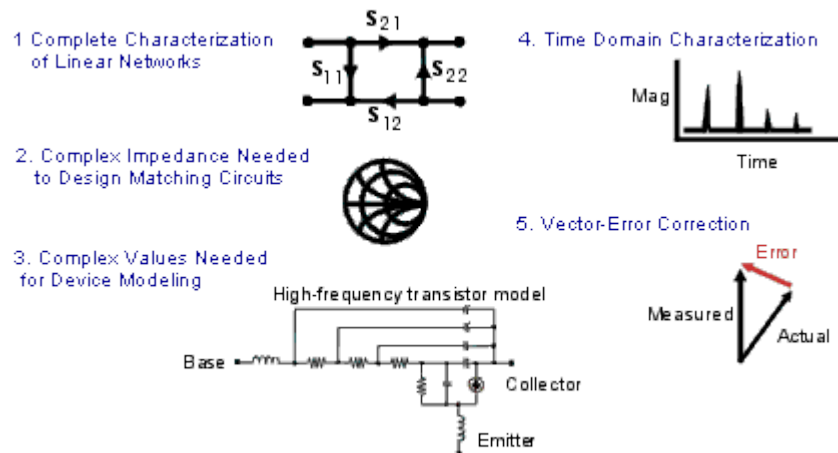

When used in communications systems to pass signals, components or circuits must not cause excessive signal distortion. This distortion can be:

- Linear, where flat magnitude and linear phase shift versus frequency is not maintained over the **bandwidth** of interest.
- Nonlinear, such as AM-to-PM conversion.

It is important to measure how reflective a component or circuit is, to ensure that it transmits or absorbs energy efficiently. Measuring the complex **impedance** of an antenna is a good example.

Using the Analyzer's Phase Format

The analyzer's phase format displays a phase-versus-frequency or phase-versus-power measurement. The analyzer does not display more than ± 180 degrees phase difference between the reference and test signals. As the phase value varies between $+180$ degrees and -180 degrees, the analyzer display creates the sawtooth pattern as shown in the following graphic.

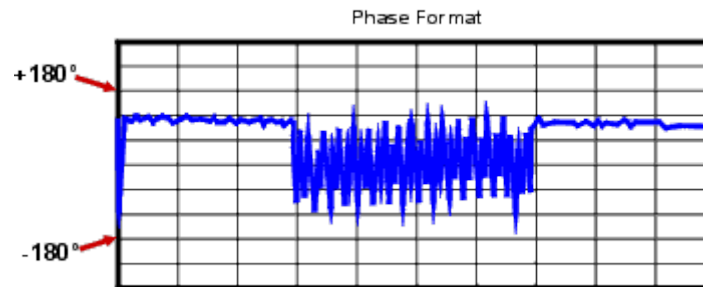

The sawtooth pattern does not always reach $+180$ degrees and -180 degrees. This is because the measurement is made at discrete frequencies, and the data point at $+180$ degrees and -180 degrees may not be measured for the selected sweep.

Types of Phase Measurements

Complex impedance data is information such as resistance, reactance, phase, and magnitude that can be determined from an S11 or S22 measurement. Complex impedance data can be viewed using either the Smith Chart format or the Polar format.

AM-to-PM conversion is a measure of the amount of undesired phase deviation (PM) that is caused by amplitude variations (AM) of the system. AM-to-PM conversion is usually defined as the change in output phase for a 1-dB increment in the input power to an amplifier (i.e. at the 1 dB gain compression point). This is expressed in degrees-per-dB ($^{\circ}/\text{dB}$).

Deviation from linear phase is a measure of phase distortion caused by a device. Ideally, the phase shift through a device is a linear function of frequency. The amount of variation from this theoretical phase shift is known as its deviation from linear phase (also called phase linearity).

Group delay is another way to look at phase distortion caused by a device. Group delay is a measure of transit time through a device at a particular frequency. The analyzer computes group delay from the derivative of the measured phase response.

Deviation from Linear Phase Versus Group Delay

Although deviation from linear phase and group delay are similar measurements, they each have their purpose.

The following are the advantages of deviation from linear phase measurements:

- Less noisy than group delay.

- Able to characterize devices that pass phase modulated signals, and show units of phase rather than units of seconds.

The following are the advantages of group delay measurements:

- More easily interpreted indication of phase distortion than deviation from linear phase.
- Able to most accurately characterize a device under test. This is because in determining group delay, the analyzer calculates the slope of the phase ripple, which is dependent on the number of ripples which occur per unit of frequency. Comparing two phase responses with equal peak-to-peak phase ripple, the response with the larger phase slope results in:
 - More group delay variation.
 - More signal distortion.

See also [Comparing the VNA Delay Functions.](#)



E5080A

Specifications

An internet connection is required to view specification documents.

Doc Number	Model
5992-0291EN	E5080A



Glossary

[A](#) [B](#) [C](#) [D](#) [E](#) [F](#) [G](#) [H](#) [I](#) [J](#) [K](#) [L](#) [M](#)
[N](#) [O](#) [P](#) [Q](#) [R](#) [S](#) [T](#) [U](#) [V](#) [W](#) [X](#) [Y](#) [Z](#)

12-Term Error Correction See [Error Correction, 12-Term](#).

1-Port Device A device with a single connector or path to the device's circuitry. Examples include an oscillator and a load.

2-Port Calibration, Full See [Error Correction, 12-Term](#).

2-Port Device A device with two connectors or other paths to the device's circuitry. Examples include filters, SAW devices, attenuators, matching pads, and amplifiers.

3-Term Error Correction See [Error Correction, 3-Term](#).

A

Active Channel The highlighted channel affected by front panel functions.

Active Function Readout The area of a display screen where the active function and its state are displayed. The active function is the one that was completed by the last key selection or remote programming command.

Active Marker The marker on a trace that can be repositioned either by front panel controls or by programming commands.

Active Trace A trace that is being swept (updated) with incoming signal information.

ADC Analog to Digital Converter

Address The identification (represented by a name, label, or number) for a register, location in storage, or any other data source or destination. Examples are the location of a station in a communications network, or a device on the GP-IB.

ADM Add-Drop Multiplexer

Admittance (Y) The inverse of an impedance (i.e. the ratio of current to voltage). Complex admittances take the form $Y = G + jB(t)$.

ALC Automatic Level Control. See [Automatic Gain Control](#).

AM Amplitude Modulation

AM Group Delay A technique for the measurement of group delay through a device which utilizes an amplitude modulated (AM) source. Note: The actual delay of the modulation envelope is measured directly with an external scalar detector. Devices that distort the amplitude of a signal cannot be measured. These include amplifiers with automatic gain control (AGC) and devices subject to saturation or power limiting.

Amplitude Modulation The process, or result of the process, of varying the amplitude of a carrier signal. The resulting modulated carrier contains information that can be recovered by demodulation. See also [Modulation](#).

Analog The general class of devices or circuits in which the output varies as a continuous function of the input.

Annotation The labeling of specific information on the display (such as frequency or power).

ANSI American National Standards Institute: A national membership organization (open to manufacturers, organizations, users, and communications carriers) that approves standards, accredits standards development groups and certificate programs, and represents and coordinates US interests in non-treaty and non-government standards bodies.

Aperture The frequency span of the network analyzer used for calculating group delay. The narrower the aperture, the finer the resolution of the group delay variations, but noise is reduced by increasing the aperture.

Array A set of numbers or characters that represents any given function.

ASCII American Standard Code for Information Interchange

Attenuation Denotes a reduction in signal amplitude. The difference between transmitted and received power due to loss through equipment, lines, or other transmission devices; usually expressed in decibels.

Attenuator An RF or microwave device used to reduce the power level of a signal by precise, incremental amounts over its entire frequency range.

Automatic Calibration System AutoCal: Feature offered on Rohde&Schwarz network analyzers.

Automatic Gain Control (AGC) A circuit used in amplifiers and other active devices to keep its RF power level constant as other parameters change, such as frequency. Synonym: Automatic Leveling Control (ALC)

Autoscale An analyzer feature that evaluates waveforms and adjusts controls to stable and enhance the display.

AUX Auxiliary; refers to rear-panel input connector.

Averaging A noise reduction technique that computes each data point based on consecutive sweeps and weighted by a user-specified averaging factor. Each new sweep is averaged into the trace until the total number of sweeps is equal to the averaging factor.

B

B/R The ratio of data sampled at B to the data sampled at R.

Band Pass A range of frequencies that are passed through a device, such as a filter. Frequencies not within the band pass are limited or attenuated. See also [Cutoff Frequency](#).

Bandwidth (BW) The difference between the frequencies of a continuous frequency band within which performance of a device falls within specifications.

Bandwidth Limit The condition prevailing when the system bandwidth is exceeded and signal distortion occurs beyond specifications.

Bandwidth Selectivity A measure of a filter's ability to resolve signals unequal in amplitude. It is the ratio of the 60 dB bandwidth to the 3 dB bandwidth for a given resolution filter (IF). Bandwidth selectivity tells us how steep the filter skirts are. Bandwidth selectivity is sometimes called shape factor.

Binary A method of representing numbers in a scale of two (on or off, high-level or low-level, one or zero). A compact, fast format used to transfer information to and from the analyzer.

BMP Bit-Mapped

Brightness See [Color Brightness](#).

Broadband Device A device that operates over a very wide frequency range and exhibits only small variations in response over that range.

Buffer A storage device used when transmitting information to compensate for a difference in the rate of flow of information between two devices.

Burst Carrier A carrier that is periodically turned off and on. A burst carrier may or may not be modulated.

BUS Basic Utility System

Bus One or more conductors used as a path to deliver transmitted information from any of several sources to any of several destinations.

BW Bandwidth

Byte Eight bits of data representing one character processed as a unit.

C

CAD Computer Aided Design

CAE Computer Aided Engineering

Calibration In HP instrumentation, the process of periodically (usually annually) verifying an instrument is performing to specifications. A calibration certificate is awarded after verification.

In network analyzers, the process of removing systematic errors from measurements. See [Error Correction](#).

Calibration Kit Hardware and software required to perform error correction on a network analyzer for a specific measurement and/or test set.

Calibration, 2-Port See [Error Correction, 12-Term](#).

Calibration, Blackburn Calibrations of transmission path with corrected source match involving 15 calibration terms. Synonym: 15-term error correction

Calibration, Frequency Response The simplest error correction procedure to perform, but only corrects for a few of the twelve possible systematic error terms. Frequency response corrections can be made for reflection measurements, transmission measurements, and isolation measurements.

Calibration, Interpolation A user selectable network analyzer feature that calculates (interpolates) new error correction terms from existing terms when there is a change in network analyzer parameters, such as IF bandwidth, power, or sweep time. The resulting error correction is not as accurate as completing a full 2-port calibration.

Calibration, Port Extension See [Port Extension](#).

Calibration, Reference Plane See [Reference Plane](#).

Calibration, Set Z Sets the system impedance, usually 50 or 75 ohms.

Calibration, SOLT A calibration using four known standards: Short-Open-Load-Through. Also known as a full two-port calibration and 12-term error correction. See also [Error Correction](#).

Calibration, TRL and LRM A calibration used in environments where the DUT cannot be connected directly to the network analyzer ports, (MMIC, microstrip, beam-lead diodes etc.). Thru-Reflect-Line (TRL) and M (Match) standards are fabricated and used because known high-quality standards are not readily available. The requirements for characterizing these standards are less stringent, but the calibration is not as accurate as the traditional full two-port calibration using S-O-L-T standards. The terms are used interchangeably (TRL, LRL, LRM etc.) but they all refer to the same basic calibration method.

Characteristic Impedance The impedance looking into the end of an infinitely long lossless transmission line.

Color Brightness A measure of the intensity (brightness) of a color.

Command A set of instructions that are translated into instrument actions. The actions are usually made up of individual steps that together can execute an operation.

Continuous Sweep Mode The analyzer condition where traces are automatically updated each time trigger conditions are met.

Controller A device capable of specifying the talker and listeners for an information transfer. An external computer connected to an instrument to control its operation.

Corrected Measurements made after performing error correction.

Coupler See [Directional Coupler](#).

CPU Central Processing Unit

Crosstalk The occurrence of a signal at one port of a device being affected by a signal in any other path. Isolation is the measurement of crosstalk.

Cursor An electronically generated pointer that moves across the display to manipulate controls.

Cutoff Frequency In filters, the frequency at which attenuation is 3dB below the band pass signal level, known as the 3dB points.

CW Continuous wave: A single frequency (rather than a swept frequency).

D

DAC Digital to Analog Converter

dB Decibel: a relative unit of measure. The ratio in dB is given by: $10 \log_{10} (P_1/P_2)$ where P_1 and P_2 are the measured powers. The dB is preferred instead of arithmetic ratios or percentages because when components are connected in series, their effect on power, expressed in dB, may be arithmetically added and subtracted. For example, if a 3dB attenuator is connected to a 10dB amplifier, the net gain of the two components is (-3dB + 10dB = +7dB).

dBm Absolute unit of measure in decibels: 0dBm = 1 mW. The conventions of the dB (adding and subtracting) continue to apply.

DBMS Database Management System

DC Direct Current

Default A known set of conditions used in the absence of user-defined conditions.

Delay See [Group Delay](#).

Demodulation The process of recovering from a modulated carrier, information in the form of a signal having essentially the same characteristics as the original modulating signal. Recovery of the modulating signal accomplished by signal detection.

Detection The process of demodulating signal carriers. There are two basic ways of providing signal detection in network analyzers: Diode detectors (used in broadband applications) and heterodyning, (used in narrowband applications).

Detector, Diode A device used to convert a RF signal to a proportional DC level. If the signal is amplitude modulated, the diode strips the RF carrier signal from the modulation. Many sources used with scalar analyzers are amplitude modulated with a 27.778 kHz signal and then detected in the network analyzer. Phase information on the signal carrier is lost in diode detection.

Deviation from Linear Phase Linear phase refers to the nature of the phase shift of a signal through a device. The phase is linear if a plot of phase shift versus frequency is a straight line using linear scales. Deviation from linear phase causes signal distortion.

Digital Pertaining to the class of devices or circuits in which the output varies in discrete steps.

Digital Demodulation Describes a technique of extracting the information used to modulate a signal. Digital signal processing algorithms are used on the signal after it has been converted from an analog to a digital form (digitized).

Dimension To specify the size of an array. The number of array rows or columns.

Directivity In a 3-port directional coupler, the ratio of the power present at the auxiliary port when the signal is traveling in the forward direction to the power present at the auxiliary port when the same signal is traveling in the reverse direction.

Directional Coupler A 3-port device typically used for separately sampling the backward (reflected) wave in a transmission line.

Disk A circular, magnetic storage medium.

Display Noun: See [Screen](#).

Verb: To show annotation and measurement data on the display.

Display Detector Mode The manner in which analog, video information is processed prior to being digitized and stored in memory.

Display Dynamic Accuracy The amplitude uncertainty, usually in dB, over the display dynamic range.

Display Dynamic Range The amplitude range, in dB, over which the display dynamic accuracy applies.

Display Formats Graphical formats for displaying measurement data. These include single channel, overlay (multiple traces on one graticule), split (each trace on separate graticules).

Display Modes The ways in which measurement data can be presented graphically. On a network analyzer, the choices are Cartesian/rectilinear (XY plot with log or linear magnitude, phase, group delay, SWR, real and imaginary, and dBV, dBmV and dBuV), polar (magnitude and angle), magnitude and phase, and Smith chart. Not all display modes are available on all network analyzers. In addition, displays can present this information in various combinations of traces. Common modes are dual, (the ability to display more than one trace, usually over the same frequency range), and alternate, (the ability to display more than one trace, each with different frequency range and type).

Display Phase Dynamic Accuracy The phase measurement uncertainty, usually in degrees, for measurements whose units are in degrees.

Display Points The total number of measurement points made in a single measurement. The points can be in units of frequency, power, or time. The number of points often dictates measurement speed, resolution, and aperture.

Display Trace Noise, Magnitude The amplitude uncertainty of the trace, in dB, due to random noise in the test system.

Display Trace Noise, Phase The phase uncertainty of the trace, in degrees, due to random noise in the test system.

Display Type The type of display screen built into the analyzer. Data can be displayed as a raster drawing (a computer-like dot map) or as a vector drawing (lines drawn on the display). Color and display standard can also be specified as monochrome (single color), or color (two or more colors). The format standard may also be specified, such as VGA or SVGA, for IBM-compatible personal computers.

Distortion Deterioration of a signal's quality due to the nonlinear characteristics of a device or system transfer function. Distortion is measured as a combination of the changes in amplitude, frequency and phase of signal at the output of a device or system as compared to the signal at the input.

Drift The slow change in signal frequency.

DSP Digital Signal Processing

DUT Device Under Test

DVM Digital Volt Meter

Dynamic Range In a receiver, the range of signal levels, from minimum to maximum, that can be reliably measured simultaneously. Dynamic range allows small signals to be measured in the presence of large signals. Source power and receiver compression usually limits the maximum boundary to dynamic range. Receiver residual responses and noise floor usually limit the minimum power boundary.

E

ECal See [Electronic Calibration](#).

Electrical Delay A simulated variable length of lossless transmission line, added to or subtracted from a receiver input, to compensate for interconnecting cables. The firmware equivalent of mechanical or analog "line stretchers" in other network analyzers.

Electronic Calibration (ECal) A calibration system for electronic calibration of RF and microwave vector network analyzers. The electronic calibration system creates a twelve-term, two-port error model and then provides a confidence check of the calibration. The Ecal system consists of a repeatable, variable-impedance, solid-state calibration standard and a mainframe control unit which interfaces with the 8510, 8720 series, and the 8753 network analyzers or a USB module which interfaces with the VNA series network analyzers.

EMC Electro-Magnetic Compatibility

EMI Electro-Magnetic Interference: Unintentional interfering signals generated within or external to electronic equipment. Typical sources could be power-line transients, noise from switching-type power supplies and/or spurious radiation from oscillators. EMI is suppressed with power-line filtering, shielding, etc.

Engage To activate a function.

Enter The process of inputting information.

EPROM Electronically Programmable, Read-Only Memory

Error Correction In network analyzers, a process that removes or reduces systematic (repeatable) measurement errors by measuring known standards from a calibration kit. Synonym: measurement calibration

Error Correction, 3-Term Used to remove systematic measurement errors on a device with one port, such as a load.

Error Correction, 12-Term Correction for a two port device using six parameters:

Directivity

Source match

Load match

Reflection frequency response

Transmission frequency response

Isolation

To completely characterize a two-port device, these six parameters must be characterized in the forward and reverse directions, making a total of 12 terms. The user usually has the option of omitting isolation from the correction process. Synonym: Full two-port error correction

Error Correction, 1-Port Corrects a test set for port 1 or port 2 directivity, frequency response, and source match errors. The process requires three known standard terminations, for example, open, short, and load.

Error Message A message on a display that indicates an error condition. Missing or failed hardware, improper user operation, or other conditions that require additional attention can cause an error condition. Generally, the requested action or operation cannot be completed until the condition is resolved.

ESD Electro Static Discharge

Ethernet A network that adheres to the IEEE 802.3 Local Area Network standard.

Ethernet address A hexadecimal number which is used to identify a machine on a network. Each analyzer is assigned a unique Ethernet address at the factory and it is stored in the analyzer's ROM.

External trigger signal A TTL signal that is input to an analyzer and initiates a measurement sweep or similar event, making the measurements synchronous with the external triggering source.

F

Filter A passive device that allows some frequencies to pass and attenuates others, depending on the type and specifications. A high-pass filter passes frequencies above the cutoff frequency, a low-pass filter passes frequencies below the cutoff frequency, and a band-pass filter passes frequencies between two specific frequencies.

Firmware An assembly made up of hardware and instruction code. The hardware and instruction code is integrated and forms a functional set that cannot be altered during normal operation. The instruction code, permanently installed in the circuitry of the instrument, is classified as ROM (read only memory). The firmware determines the operating characteristics of the instrument or equipment.

Flatness The amplitude and phase response of a device under test (DUT), a signal source, a receiver, or a combination of these. See also [Frequency Response](#).

FM Frequency Modulation

Frequency The number of periodic oscillations, vibrations, or waves per unit of time, usually expressed in cycles per second, or Hertz (Hz).

Frequency Accuracy The uncertainty with which the frequency of a signal or spectral component is indicated, either in an absolute sense or relative to another signal or spectral component. Absolute and relative frequency accuracies are specified independently.

Frequency Range The range of frequencies over which a device or instrument performance is specified.

Frequency Resolution The ability of a network analyzer to measure device characteristics at closely spaced frequencies and display them separately. Resolution of equal amplitude responses is determined by IF bandwidth. Resolution of unequal amplitude responses is determined by IF bandwidth and bandwidth selectivity.

Frequency Response The peak-to-peak variation in the displayed amplitude response over a specified center frequency range. Frequency response is typically specified in terms of dB, relative to the value midway between the extremes.

Frequency Span The magnitude of the displayed frequency component. Span is represented by the horizontal axis of the display. Generally, frequency span is given as the total span across the full display. Some analyzers represent frequency span (scan width) as a per-division value.

Frequency Stability The ability of a frequency component to remain unchanged in frequency or amplitude over short and long-term periods of time. Stability refers to an oscillator's ability to remain fixed at a particular frequency over time.

Front Panel Key Keys that are located on the front panel of an instrument. The key labels identify the function the key activities. Numeric keys and step keys are two examples of front panel keys.

Full 2-Port Calibration See [Error Correction, 12-Term](#).

Function The action or purpose that a specific item is intended to perform or serve. The network analyzer contains functions that can be executed via front panel key selections, or through programming commands. The characteristics of these functions are determined by the firmware in the instrument. In some cases, a DLP (downloadable program) execution of a function allows you to execute the function from front panel key selections.

Fundamental Frequency In any waveform, the lowest frequency component; all other components are harmonics. A pure sinusoid has only one component, the fundamental.

G

Gb Gigabit

GB Gigabyte

GHz Gigahertz

GIF Graphics Interchange Format - Standard graphic format to store bitmapped graphics files.

Giga Prefix for one billion.

GP I/O General Purpose Input / Output; a connector usually on the back of an instrument that allows communication with other test equipment, external test sets, switches, and computers that enable the instrument to be triggered or to trigger external equipment. An example is a foot switch that continues or cycles a measurement, allowing the operator to use both hands on the test hardware.

GPIB General Purpose Interface Bus - IEEE 488 bus is interconnect bus and protocol, allows linking of instruments and computer.

Graticule (or Grid) Enclosed area where waveform is displayed on instrument. Tick marks, on frame or axis, are a scaling aid for making visual measurements.

Group Delay A measure of the transit time of a signal through a DUT versus frequency. Group delay can be calculated by differentiating the DUT's insertion-phase response with respect to frequency. See also [AM Group Delay](#) and [Deviation from Linear Phase](#).

GUI Graphical User Interface

H

Hardcopy Paper copy of data.

Hardkey A front-panel key, which engages a single analyzer function or presents a single menu of softkeys.

Horizontal Reference See [Reference Level](#).

Horizontal Resolution The analyzer's ability to take closely spaced horizontal data points over the full sweep.

Host Computer A computer or device on a network that provides end users with services such as computation and database access and that usually performs network control functions.

Host Name A unique name that is used to identify each host machine on a network. The host name is directly linked to, and can usually be used in place of, the IP address. The user or the system administrator usually creates the host name.

HP Hewlett-Packard Company

HPGL Hewlett-Packard Graphics Language

HP-IB Hewlett-Packard Interface Bus. A parallel interface that allows "daisy chaining" of more than one device to a port on a computer or instrument. Interface protocol is defined in IEEE 488.2; equivalent to the industry standard GPIB.

HTTP HyperText Transfer Protocol: Used to carry World Wide Web (WWW) traffic.

Hue The dimension of color referred to a scale of perceptions ranging from red through yellow, green, and blue, and back to red. A particular gradation of color, tint, shade.

I

I/O Input/Output

I/O Path Input/Output Path

IEEE Institute of Electrical and Electronic Engineers

IF Intermediate Frequency: the frequency at which a signal is processed after mixing.

Impedance The ratio of voltage to current at a port of a circuit, expressed in ohms.

Initialize The process that assigns information locations to a disk to prepare the magnetic media to accept files.

Input A path intended for putting a signal into an instrument.

Most network analyzers have either 3 (labeled A, B, and R) or 4 inputs (labeled A, B, R1, and R2). Inputs are not the same as channels.

Input Attenuator An attenuator between the input connector and the first mixer of a spectrum analyzer (also called an RF attenuator). The input attenuator is used to adjust the signal level incident to the first mixer, and to prevent gain compression due to high-level or broadband signals. It is also used to set the dynamic range by controlling the degree of internally-generated distortion. For some analyzers, changing the input attenuator settings changes the vertical position of the signal on the display, which then changes the reference level accordingly. In Keysight microprocessor-controlled analyzers, the IF gain is changed to compensate for changes in input attenuator settings. Because of this, the signals remain stationary on the display, and the reference level is not changed.

Insertion Loss The difference between the power measured before and after the insertion of a device. The attenuation between the input and output of a device.

Intensity Brightness; emitting or reflecting light; luminosity.

Interface A connection that allows a common communication link between two or more instruments.

Intermodulation Distortion Undesired frequency components resulting from the interaction of two or more spectral components passing through a device having nonlinear behavior, such as a mixer or an amplifier. The undesired components are related to the fundamental components by sums and differences of the fundamentals and various harmonics. The algorithm is: $f_1 \pm f_2$, $2xf_1 \pm f_2$, $2xf_2 \pm f_1$, $3xf_1 \pm 2x f_2$, and so on.

Internet The connection of two or more distinct networks. Often a gateway or router is used to make the connection.

Interpolate To determine a value of a signal between to adjacent points by a procedure or algorithm.

IP Internet Protocol

IP Address Internet protocol address: a unique number that is assigned to each device which is to be connected to a TCP/IP network. Before using an analyzer on a network, your network administrator will need to assign an IP address. An IP address consists of a 32-bit value presented in decimal dot notation: 4 octets (bytes) separated by a dot.

ISDN Integrated Services Digital Network: A standard digital service capability that features one or more circuit-switched communication channels capable of carrying digital voice, data, or image signals, a packet-switched channel for out-of-band signaling and control. In addition, ISDN provides a collection of standard and optional features that support information productivity for the user, providing higher-speed Internet access than analog systems.

ISO International Standards Organization

Isolation A specification or measure of the immunity that one signal has to being affected by another adjacent signal. The occurrence is known as crosstalk.

Isolator An RF device used for providing isolation between paths and components. Made from a 3-port circulator, the third port being terminated in a 50ohm load.

J

K

Kilo Prefix for one thousand.

KB Kilobyte

Kb/s Kilobytes per second

L

LAN Local Area Network

LANS Local Area Network System

LCD Liquid Crystal Display

LED Light Emitting Diode

LIF Logical Interchange Format (used for older HP disk drives/computers)

Limit Lines Lines input by the user that overlay the analyzer's measurement data to allow automatic detection of data that is out of the acceptable range. Pass/Fail annotation, audio alarms, or electronic output can be triggered to notify the operator or on-line computer program of the over-limit condition.

Limit-Line File The user-memory file that contains the limit-line table entries.

Limit-Line Table The line segments of a limit line are stored in the limit-line table. The table can be recalled to edit the line segments, then restored in the limit-line file.

Linear Device A device in which the output is continuously proportional to the input.

LO Local Oscillator. In a superheterodyne system, the LO is mixed with the received signal to produce a sum or difference equal to the intermediate frequency (IF) of the receiver.

LO Feedthrough The response that in a superheterodyne system when the first local oscillator frequency is equal to the first IF.

Load A one port microwave device used to terminate a path in its characteristic impedance.

Load Match A measure of how close the device's terminating load impedance is to the ideal transmission line impedance. Match is usually measured as return loss or standing wave ratio (SWR) of the load.

Local Lock Out A condition or command that prevents analyzer front-panel entries (and disables the Local key).

Local Operation To operate manually from the front panel.

Log Logarithm

Log Display The display mode in which vertical deflection is a logarithmic function of the input signal amplitude. Log display is also called logarithmic display. The display calibration is set by selecting the value of the reference level position and scale factor in dB per division.

LRM Line-Reflect-Match. See [Calibration, TRL, and LRM](#).

M

Magnitude The amplitude of a signal measured in its characteristic impedance without regard to phase. See also [Scalar](#).

Marker A graphical symbol along a display trace that is annotated with measurement characteristics of that specific data point.

Marker Functions Mathematical or statistical computation on the data of one or more markers to provide the operator more information. For example, the marker delta function calculates and displays the difference between two markers.

Maximum Input Level The maximum signal power that may be safely applied to the input of an analyzer. The maximum input level is typically 1 W (+30 dBm) for Keysight spectrum analyzers.

MB Megabyte

Measurement Uncertainty The quantified amount of error in a measurement situation. Calibrations are intended to reduce the amount of uncertainty. The following are sources of measurement errors that lead to uncertainty:

- Systematic errors (imperfections in calibration standards, connectors, cables, and instrumentation)
- Random errors (noise, connector repeatability)
- Drift (source and instrumentation)

Mega Prefix for one million.

Memory A storage medium, device, or recording medium into which data can be stored and held until some later time, and from which the entire original data may be retrieved.

Memory Card A small memory device shaped like a credit card that can store data or programs.

Menu The analyzer functions that appear on the display and are selected by pressing front panel keys. These selections may invoke a series of other related functions that establish groups called menus.

MHz Megahertz

milli Prefix for one-thousandth.

Modem Modulator/Demodulator

Modulation The process, or the result of the process, of varying a characteristic of a carrier signal with an information-bearing signal, causing the carrier to contain the information. See [AM](#) and [FM](#).

Monitor Any external display.

Monochrome Having only one color (chromaticity).

ms Millisecond

mW Milliwatt: one thousandth of a watt

Multisync A type of monitor that can synchronize its horizontal sweep to various frequencies within a specified range.

N

Narrowband In network analysis, the frequency resolution of the analyzer's receiver that is sufficiently narrow to resolve the magnitude and phase characteristics of narrowband devices. The reduced receiver bandwidth usually decreases the noise floor of the receiver, providing more measurement amplitude range.

Narrowband Device A device whose transfer characteristics are intended to operate over a very narrow frequency range and are designed to provide well-defined amplitude responses in that range, such as a band pass filter.

Network Analysis The characterization of a device, circuit, or system derived by comparing a signal input going into the device to a signal or signals coming out from the device.

NIST National Institute of Standards and Technology

Nit The unit of luminance (photometric brightness) equal to one candela per square meter.

Noise Random variations of unwanted or disturbing energy in a communications system from man-made and natural sources that affects or distorts the information carried by the signal. See also [Signal-to-Noise Ratio](#).

Noise Figure (F): For a two-port device, a measure of how the noise generated inside the device degrades the signal-to-noise ratio of a signal passing through the device at 290 degrees, usually expressed in dB.

Noise Floor The analyzer's internal displayed noise. The noise level often limits how small a signal magnitude can be measured. In network analysis, noise floor is measured with the test ports terminated in loads, full two-port error correction, 10 Hz IF bandwidth, maximum test port power, and no averaging during the test.

Non-Insertable Devices In measurement calibration, a device that cannot be substituted for a [Zero-Length Through Path](#). It has the same type and sex connectors on each port, or a different type of connector on each port.

Nonvolatile Memory Memory data that is retained in the absence of an ac power source. This memory is typically retained with a battery. Refer also to battery-backed RAM.

Normalize To subtract one trace from another to eliminate calibration data errors or to obtain relative information.

O

Offset To move or set off a determined amount. Used in instruments for offsetting frequencies, limits, delay, loss, impedance, etc.

Output Attenuation The ability to attenuate the signal, the source, in order to control its power level.

P

PC Personal Computer

PDF Portable Document Format (used on the Web)

Parser, Command Reads program messages from the input queue of a device in the order they were received from the controller. The parser determines what actions the analyzer should take. One of the most important functions of the command parser is to determine the position of a program message in the analyzer SCPI command tree. When the command parser is reset, the next element it receives is expected to arise from the base of the analyzer command tree.

Peak Search A function on an analyzer that searches for the largest response and places a marker on it.

Phase The fractional part of a cycle through which an oscillation has advanced, measured from an arbitrary starting point; usually measured in radians or degrees. In network analysis, the phase response of the device under test is the change in phase as a function of frequency between the input stimulus and the measured response.

Port The physical input or output connection of an instrument or device.

Port Extension Redefining the reference plane to other than that established at calibration. A new reference plane is defined in seconds of delay from the test set port.

Positive Peak The maximum, instantaneous value of an incoming signal.

Postscript (.ps files) Stores bitmapped graphics files in an encapsulated format for direct use by postscript printers.

Power, Max Input The upper limit to input power for which the specifications apply. Some specifications may have different levels of maximum inputs. For example, compression power maximum is usually higher than the harmonic distortion maximum.

Power, Safe Input The input power, usually in dBm, allowed without damaging the instrument.

Preset A pre-defined instrument state (that also runs an analyzer self-test). The action of pushing the Preset key.

Protocol A set of conventions that specify how information will be formatted and transmitted on a network, and how machines on a network will communicate.

Q

Q or Q Factor The ratio of energy stored to energy lost in a resonant circuit. High Q indicates a sharp resonance response over frequency.

Query Any analyzer programming command having the distinct function of returning a response. These commands may end with a question mark (?). Queried commands return information to the computer.

R

r + jx Expression for complex impedance, where r represents the resistive portion and x represents the reactive portion.

R Channel Reference Channel

RAM Random Access Memory, or read-write memory: A storage area allowing access to any of its storage locations. Data can be written to or retrieved from RAM, but data storage is only temporary. When the power is removed, the information disappears. User-generated information appearing on a display is RAM data.

ROM Read Only Memory: A storage area that can be read only; it cannot be written to or altered by the user. In instruments, the storage area that contains the "brains" or operational programming; the firmware.

Receiver A circuit or system designed for the reception and/or measurement of signals in a specified frequency spectrum.

Receiver Dynamic Range See [Dynamic Range](#).

Reference Level An instrument function that allows the user to set the amplitude value at the reference position. On network analyzers, the reference position is also selectable. On some spectrum analyzers, the reference position is fixed at the top of the display.

Reference Plane The electrical location at which a network analyzer assumes the system connectors and fixturing ends and the DUT begins. The reference plane is set by using calibration standards with known electrical length. The closer the reference plane is to the device under test (DUT), the better the characterization of the device because of the elimination of test system uncertainties.

Reference Receiver In a network analyzer, the receiver that measures signals as they come out of the source, before they are incident on the test port and DUT. Typically, these signals are used to compare with the signal at the Test Port Receiver, to determine the affect that the DUT has on the signal. In a 2-port network analyzer, these are typically named 'R1' (port 1) and 'R2' (port 2). [See a block diagram](#) of the receivers in your VNA.

Reflection The phenomenon in which a traveling wave strikes a discontinuity and returns to the original medium.

Reflection Coefficient The ratio of the reflected voltage to the incident voltage into a transmission line or circuit. If a transmission line is terminated in its characteristic impedance, the reflection coefficient is zero. If the line is shorted or open the coefficient is 1. See also [Return Loss](#) and [SWR](#).

Reflection Measurements Measurements that characterize the input and /or output behavior of the device under test (DUT). Measured as the ratio of the reflected signal to the incident signal as a function of frequency. Parameters are called return loss, reflection coefficient, impedance, and standing wave ratio (SWR), all as a function of frequency. See also [S-Parameters](#).

Remote A mode of operation where another device (or computer) controls an instrument via the HP-IB. In this mode, the instrument front panel keys are disabled. Front panel operation is called local operation.

Remote Programming The automatic operation of an instrument by a computer, usually through a HP-IB, LAN, or RS-232 link.

Resolution The ability of a receiver to resolve two signals.

Resolution Bandwidth The ability of a spectrum analyzer to display adjacent responses discretely (Hertz, Hertz decibel down). This term is used to identify the width of the resolution bandwidth filter of a spectrum analyzer at some level below the minimum insertion loss point (maximum deflection' point on the display). Typically, it is the 3 dB resolution bandwidth that is specified, but in some cases the 6 dB resolution bandwidth is specified.

Return Loss The amount of dB that the reflected signal is below the incident signal. If zero signal is reflected, the impedance of the device is equal to the characteristic impedance of the transmission system, and return loss is infinite. If the entire incident signal is reflected, the return loss is zero. See also [S-Parameters](#), [Reflection Coefficient](#), and [SWR](#).

Reverse Measurement The measurement of a device from output to input.

RF Radio Frequency (from approximately 50 kHz to approximately 3 GHz). Usually referred to whenever a signal is radiated through the air.

ROM Read Only Memory

S

S/N Signal-to-Noise Ratio

Sampler An electronic component that captures the signal level and phase across a known impedance at a uniform rate. In Network Analyzers, this sampling rate must be sufficiently high and precisely timed to make accurate measurements. Network analyzers typically have three or four samplers or mixers.

Sampler Bounce The leakage or crosstalk between a network analyzer's samplers. Delay in this crosstalk caused by leakage transmission propagation, give the interference its "bounce" appearance. Sampler bounce causes an increase in the noise level of the affected channel, reducing the sensitivity of the analyzer.

Saturation The degree of color purity, on a scale from white to pure color.

Scalar A quantity that has magnitude but no phase. A network analyzer capable of measuring only magnitude.

Scale Factor The display vertical axis calibration in terms of units per division.

SCPI Standard Commands for Programmable Instruments

Screen The physical surface of the CRT or flat panel upon which the measurement results, setup information, softkey definitions, and other instrument communication is presented.

Self-Test A group of tests performed at power-up (or at preset) that verify proper instrument operation.

Sensitivity The minimum input signal required to produce a specified output signal having a specified signal-to-noise ratio, or other specified criteria.

On a spectrum analyzer, the level of the smallest sinusoid that can be observed, usually under optimized conditions of minimum resolution bandwidth, 0 dB input attenuation, and minimum video bandwidth.

The normalized change in YIG component's center frequency resulting from a change in tuning coil current, specified in MHz/mA.

Serial Prefix The five-character prefix that begins an instrument serial number; used to represent versions of firmware or hardware changes that have occurred.

Server A device that is configured to provide a service to other devices on a network, such as shared access to a file system or printer.

Signal-to-Noise Ratio SNR: The ratio of the amplitude of the desired signal to the amplitude of noise signals, usually expressed in dB and in terms of peak values for impulse noise and root-mean-square values for random noise.

Single Sweep Mode The spectrum analyzer sweeps once when trigger conditions are met. Each sweep is initiated by pressing an appropriate front panel key, or by sending a programming command.

Small Signal Gain Compression A situation when the input signal's measured amplitude is less than its actual level due to overloading of the network analyzer's input mixer; the analyzer is operating nonlinearly. For broadband analyzer detectors, a signal other than the one under test can put the analyzer into this gain compressed mode, thereby making even lower level signals appear at a lower level than actual. The broadband mode measures all the power incident to the analyzer, not just the signals at the frequency of interest.

Smith Chart A graphical mapping of the complex reflection coefficient into normalized complex impedance. Circles on the chart represent constant resistance and radiating lines orthogonal to the circles represent constant reactance. The center of the chart represents the characteristic impedance of the transmission system. Any point on the chart defines a single complex impedance. A line on the chart represents changing impedance over frequency.

SOLT Short-Open-Load-Through calibration. See also [Calibration, SOLT](#).

Source A device that supplies signal power; a sweep oscillator or synthesized sweeper.

Source Amplitude Accuracy The amplitude uncertainty, in dB, of the source power readout.

Source Amplitude Flatness The amplitude flatness, in dB, of the source power over the frequency range specified.

Source Frequency Resolution The smallest unit of frequency which can be set and/or measured, in Hz.

Source Frequency Time Base Accuracy A measure of the analyzer's frequency stability measured in parts per million (ppm, or 1 part in 10E6). For example, a stability of ± 5.0 ppm means that an analyzer will measure 1 MHz to an accuracy of $\pm 5 \times 10^{-6} \times 10E6$ Hz = +5 Hz.

Source Frequency Time Base Stability A measure of the analyzer's time base accuracy over time and temperature. Typically the time base accuracy will be specified for 1 year. A typical temperature frequency stability is ± 10 ppm for $250\text{ C} \pm 50\text{ C}$.

Source Harmonics The level of harmonics generated by the analyzer's signal source, in dBc from the fundamental.

Source Match A measure of how close the signal source impedance is to the ideal transmission line impedance of the test system. Match is usually measured as return loss or standing wave ratio (SWR) of the source.

Span The stop frequency minus the start frequency. The span setting determines the horizontal-axis scale of the analyzer display.

Span Accuracy The uncertainty of the indicated frequency separation of any two signals on the display.

S-Parameters (Scattering Parameters) A convention used to characterize the way a device modifies signal flow using a network analyzer. A two port device has four S-parameters: forward transmission (S21), reverse transmission (S12), forward reflection (S11), and reverse reflection (S22).

Stop/Start Frequency Terms used in association with the stop and start points of the frequency measurement range. Together they determine the span of the measurement range.

Storage States The number of settings, programs, traces, and other parameters available to be saved, cataloged, and recalled at any one time.

Storage, Disk An internal or external digital storage disk for saving test data, instrument settings, IBASIC programs, and other measurement parameters. Storage formats include MS-DOS (R) and HPs standard LIF with binary, PCX, HP-GL, or ASCII data formats.

Structural Return Loss Poor return loss in cable due to a periodic fault such as a periodic dent caused by dropping the cable spool or by the cable pulling process during manufacture.

Supplemental Characteristics Typical but non-warranted performance parameters, denoted as "typical", "nominal" or "approximate".

Sweep The ability of the source to provide a specified signal level over a specified frequency range in a specified time period. Also see [Sweep Mode](#) and [Sweep Type](#).

In data processing mode, a series of consecutive data point measurements, taken over a sequence of stimulus values.

Sweep Mode The way in which a sweep is initiated or selected, e.g., single, continuous, alternate, or chopped.

Sweep Type The method of sweeping the source, e.g., linear, log, or frequency step.

Sweeper A signal source that outputs a signal that varies continuously in frequency.

SWR Standing Wave Ratio, calculated as $(1 + \pi) / (1 - \pi)$ where π is the reflection coefficient.

Sync Synchronization, or Synchronized

Syntax The grammar rules that specify how commands must be structured for an operating system, programming language, or applications.

System Dynamic Range The difference between the maximum receiver input level and the receiver's noise floor. System dynamic range applies to transmission measurements only, since reflection measurements are limited by directivity.

T

T/R See [Transmission/Reflection](#).

Termination A load connected to a transmission line or other device.

Test Limit The acceptable result levels for any given measurement.

Test Port See [Port](#).

Test Port Receiver In a network analyzer, the receiver directly behind the test ports, used to measure the signal as it is reflected off, or transmitted through, the DUT. This signal is typically compared with the signal at the [Reference Receiver](#) to determine how the DUT affects a signal. In a 2-port network analyzer, these are typically named 'A' (port 1) and 'B' (port 2). [See a block diagram](#) of the receivers in your VNA.

Test Set The arrangement of hardware (switches, couplers, connectors and cables) that connect a test device input and output to the network analyzer's source and receiver to make s-parameter measurements.

Third Order Intercept TOI: The power input to a non-linear device that would cause third order distortion at the same power level. TOI is a measurement to determine the distortion characteristics of a mixer or receiver. The higher the value, the more immune the receiver to internal distortion.

Thru Through line: A calibration standard. See [Calibration, SOLT](#).

Tint A shade of color; hue.

Toggle To switch states, usually to change a function from on to off, or off to on.

TOM Thru-Open-Match: A Rohde&Schwarz term to describe a calibration method.

Trace A series of data points containing frequency and response information. The series of data points is often called an array. The number of traces is specific to the instrument.

Tracking The ability of the analyzer's receiver to tune to the source frequency over the measurement frequency range. Poor tracking results in amplitude and phase errors due to the receiver IF circuits attenuating and delaying the device under test output.

Transfer Function The ratio of the output signal to the stimulus signal, both as a function of frequency.

Transmission See [Transmission Measurements](#).

Transmission Intermodulation Spurious A measure of the capability of the transmitter to inhibit the generation of intermodulation distortion products. Intermodulation spurious is sometimes called intermodulation attenuation.

Transmission Measurements The characterization of the transfer function of a device, that is, the ratio of the output signal to the incident signal. Most common measurements include gain, insertion loss, transmission coefficient, insertion phase, and group delay, all measured over frequency. See also [S-Parameters](#).

Transmission/Reflection (T/R) Refers to the suite of measurements made by a scalar or vector network analyzer to characterize a device's behavior over frequency. See also [S-Parameters](#).

Transparent Something that is not visible to the user. Usually a procedure that occurs without the user's initiation or knowledge.

Trigger A signal that causes the instrument to make a measurement. The user can select several options for triggering, such as manual, continuous, or external (for synchronizing measurements to an external source).

TRL Through-Reflect-Line. See [Calibration, TRL and LRM](#).

TTL Transistor-Transistor Logic

Two-Port Error Correction See [Error Correction, 12-Term](#).

U

Uncorrected Measurements made without performing error correction.

Uncoupled Channels Stimulus or receiver settings allowed to be set independently for each channel.

UNI User-Network Interface: The point at which users connect to the network.

Units Dimensions on the measured quantities. Units usually refer to amplitude quantities because they can be changed. In analyzers with microprocessors, available units are dBm (dB relative to 1 mW dissipated in the nominal input impedance), dBmV (dB relative to 1 mV), dBW (dB relative to 1 W), V (volts), W (watts).

V

Variable A symbol, the value of which changes either from one iteration of a program to the next, or within each iteration of a program.

Vector A quantity that has both magnitude and phase.

A network analyzer capable of measuring both magnitude and phase.

VEE Visual Engineering Environment (Keysight software product)

Velocity Factor A numerical value related the speed of energy through transmission lines with different dielectrics (.66 for polyethylene). Used in making time domain measurements.

Vertical Resolution The degree to which an instrument can differentiate amplitude between two signals.

Video An electrical signal containing timing, intensity, and often color information that, when displayed, gives a visual image.

Video Bandwidth In spectrum analyzers, the cutoff frequency (3 dB point) of an adjustable low-pass filter in the video circuit. When the video bandwidth is equal to or less than the resolution bandwidth, the video circuit cannot fully respond to the more rapid fluctuations of the output of the envelope detector. The

result is a smoothing of the trace, or a reduction in the peak-to-peak excursion, of broadband signals such as noise and pulsed RF when viewed in broadband mode. The degree of averaging or smoothing is a function of the ratio of the video bandwidth to the resolution bandwidth.

Video Filter In spectrum analyzers, a post-detection, low-pass filter that determines the bandwidth of the video amplifier. It is used to average or smooth a trace. Refer also to [Video Bandwidth](#).

VNA Vector Network Analyzer

W

Waveform A representation of a signal plotting amplitude versus time.

Wireless A term that refers to a broad range of technologies that provide mobile communications for home or office, and "in-building wireless" for extended mobility around the work area, campus, or business complex. It is also used to mean "cellular" for in-or out-of-building mobility services.

WWW World Wide Web

X

Y

Z

Zero-Length Through Path In a measurement calibration, when the two test cables mate together directly without using adapters or a thru-line. See also [Non-Insertable Devices](#).

Glossary

1

1-port device: A device with a single connector or path to the device's circuitry. Examples include an oscillator and a load.

12-term error correction: See Error correction, 12-term

15-term error correction: See Error correction, 15-term

2

2-port calibration, full: See Error correction, 12-term

2-port device: A device with two connectors or other paths to the device's circuitry. Examples include filters, SAW devices, attenuators, matching pads, and amplifiers.

3

3-term error correction: See Error correction, 3-term

A

Active Channel: The highlighted channel affected by front panel functions.

Active function readout: The area of a display screen where the active function and its state are displayed. The active function is the one that was completed by the last key selection or remote programming command.

Active marker: The marker on a trace that can be repositioned either by front panel controls or by programming commands.

Active trace: The trace that is being swept (updated) with incoming signal information.

ADC: Analog To Digital Converter

Address: The identification (represented by a name, label, or number) for a register, location in storage, or any other data source or destination. Examples are the location of a station in a communications network, or a device on the HP-IB.

ADM: Add-Drop Multiplexer

Admittance Y: The inverse of an impedance (i.e. the ratio of current to voltage). Complex admittances take the form $Y = G + jB(t)$

ALC: Automatic Level Control. See Automatic Gain Control

AM: Amplitude Modulation

AM group delay: A technique for the measurement of group delay through a device which utilizes an amplitude modulated (AM) source. Note: The actual delay of the modulation envelope is measured directly with an external scalar detector. Devices that distort the amplitude of a signal cannot be measured. These include amplifiers with automatic gain control (AGC) and devices subject to saturation or power limiting.

Amplitude Modulation: The process, or result of the process, of varying the amplitude of a carrier signal. The resulting modulated carrier contains information that can be recovered by demodulation. See also modulation

Analog: The general class of devices or circuits in which the output varies as a continuous function of the input.

Annotation: The labeling of specific information on the CRT (such as frequency or power).

ANSI: American National Standards Institute: A national membership organization (open to manufacturers, organizations, users, and communications carriers) that approves standards, accredits standards development groups and certificate programs, and represents and coordinates US interests in non-treaty and non-government standards bodies.

Aperture: The frequency span of the network analyzer used for calculating group delay. The narrower the aperture, the finer the resolution of the group delay variations, but noise is reduced by increasing the aperture.

Array: A set of numbers or characters that represents any given function.

ASCII: American Standard Code for Information Interchange.

Attenuation: Denotes a reduction in signal amplitude. The difference between transmitted and received power due to loss through equipment, lines, or other transmission devices; usually expressed in decibels.

Attenuator: An RF or microwave device used to reduce the power level of a signal by precise, incremental amounts over its entire frequency range.

Automatic Calibration System: AutoCal: Feature offered on Rohde&Schwarz network analyzers

Automatic Gain Control (AGC): A circuit used in amplifiers and other active devices to keep its RF power level constant as other parameters change, such as frequency. Synonym: Automatic Leveling Control (ALC)

Autoscale: An analyzer feature that evaluates waveforms and adjusts controls to stable and enhance the display.

AUX: Auxiliary; refers to rear-panel input connector.

Averaging: A noise reduction technique that computes each data point based on consecutive sweeps and weighted by a user-specified averaging factor. Each new sweep is averaged into the trace until the total number of sweeps is equal to the averaging factor.

B

B/R: The ratio of data sampled at B to the data sampled at R.

Band Pass: A range of frequencies that are passed through a device, such as a filter. Frequencies not within the band pass are limited or attenuated. See also cutoff frequency

Bandwidth (BW): The difference between the frequencies of a continuous frequency band within which performance of a device falls within specifications.

Bandwidth Limit: The condition prevailing when the system bandwidth is exceeded and signal distortion occurs beyond specifications.

Bandwidth selectivity: A measure of the spectrum analyzer ability to resolve signals unequal in amplitude. It is the ratio of the 60 dB bandwidth to the 3 dB bandwidth for a given resolution filter (IF). Bandwidth selectivity tells us how steep the filter skirts are. Bandwidth selectivity is sometimes called shape factor.

Binary: A method of representing numbers in a scale of two (on or off, high-level or low-level, one or zero). A compact, fast format used to transfer information to and from the analyzer.

BMP: Bit-Mapped

Brightness: See Color Brightness.

Broadband device: A device that operates over a very wide frequency range and exhibits only small variations in response over that range.

Buffer: A storage device used when transmitting information to compensate for a difference in the rate of flow of information between two devices.

Burst carrier: A carrier that is periodically turned off and on. A burst carrier may or may not be modulated.

BUS: Basic Utility System

BW: Bandwidth

Byte: Eight bits of data representing one character processed as a unit.

C

CAD: Computer Aided Design

CAE: Computer Aided Engineering

Calibration: In HP instrumentation, the process of periodically (usually annually) verifying an instrument is performing to specifications. A calibration certificate is awarded after verification. In network analyzers, the process of removing systematic errors from measurements. See Error correction

Calibration kit: Hardware and software required to perform error correction on a network analyzer for a specific measurement and/or test set.

Calibration, 2-port: See Error correction, 12-term

Calibration, Blackburn: Calibrations of transmission path with corrected source match involving 15 calibration terms. Synonym: 15-term error correction.

Calibration, frequency response: The simplest error correction procedure to perform, but only corrects for a few of the twelve possible systematic error terms. Frequency response corrections can be made for reflection measurements, transmission measurements, and isolation measurements.

Calibration, interpolation: A user selectable network analyzer feature that calculates (interpolates) new error correction terms from existing terms when there is a change in network analyzer parameters, such as IF bandwidth, power, or sweep time. The resulting error correction is not as accurate as completing a full 2-port calibration.

Calibration, port extension: Redefining the reference plane to other than that established at calibration. A new reference plane is defined in seconds of delay from the test set port.

Calibration, reference plane: The reference plane is the electrical location in which the network analyzer assumes the system connectors and fixturing ends and the DUT begins. The reference plane is set by using calibration standards with known electrical length.

Calibration, set Z: Sets the system impedance, usually 50 or 75 ohms.

Calibration, SOLT: A calibration using four known standards: Short-Open-Load-Through. Also known as a full two-port calibration. See also error correction

Calibration, TRL and LRM: A calibration used in environments where the DUT cannot be connected directly to the network analyzer ports, (MMIC, microstrip, beam-lead diodes etc.). Thru-Reflect-Line (TRL) and M (Match) standards are fabricated and used because known high-quality standards are not readily available. The requirements for characterizing these standards are less stringent, but the calibration is not as accurate as the traditional full two-port calibration using S-O-L-T standards. The terms are used interchangeably (TRL, LRL, LRM etc.) but they all refer to the same basic calibration method.

Characteristic impedance: The impedance looking into the end of an infinitely long lossless transmission line.

- Color Brightness:** A measure of the intensity (brightness) of a color.
- Command:** A set of instructions that are translated into instrument actions. The actions are usually made up of individual steps that together can execute an operation. See also to function.
- Continuous sweep mode:** The analyzer condition where traces are automatically updated each time trigger conditions are met.
- Controller:** A device capable of specifying the talker and listeners for an information transfer. An external computer connected to an instrument to control its operation.
- Converter:** See frequency converter
- Corrected:** Measurements made after performing error correction.
- Coupler:** See directional coupler
- CPU:** Central Processing Unit.
- Crosstalk:** The occurrence of a signal at one port of a device being affected by a signal in any other path. Isolation is the measurement of crosstalk.
- Cursor:** An electronically generated pointer that moves across the trace to identify point values.
- Cutoff frequency:** In filters, the frequency at which attenuation is 3dB below the band pass signal level, known as the 3dB points.
- CW:** Continuous wave: A single frequency (rather than a swept frequency).

D

- DAC:** Digital to analog converter
- dB:** Decibel: a relative unit of measure. The ratio in dB is given by: where P 1 and P 2 are the measured powers. The dB is preferred instead of arithmetic ratios or percentages because when components are connected in series, their effect on power, expressed in dB, may be arithmetically added and subtracted. For example, if a 3dB attenuator is connected to a 10dB amplifier, the net gain of the two components is (-3dB + 10dB = +7dB)
- dBm:** Absolute unit of measure in decibels: 0dBm = 1 mW. The conventions of the dB (adding and subtracting) continue to apply.
- DBMS:** Database Management System
- DC:** Direct Current
- Default:** A known set of conditions used in the absence of user-defined conditions.
- Delay:** See Group delay
- Demodulation:** The process of recovering from a modulated carrier, information in the form of a signal having essentially the same characteristics as the original modulating signal. Recovery of the modulating signal accomplished by signal detection.
- Detection:** The process of demodulating signal carriers. There are two basic ways of providing signal detection in network analyzers: Diode detectors (used in broadband applications) and heterodyning, (used in narrowband applications).
- Detector, diode:** A device used to convert a RF signal to a proportional DC level. If the signal is amplitude modulated, the diode strips the RF carrier signal from the modulation. Many sources used with scalar analyzers are amplitude modulated with a 27.778 kHz signal and then detected in the network analyzer. Phase information on the signal carrier is lost in diode detection.

Deviation from linear phase: Linear phase refers to the nature of the phase shift of a signal through a device. The phase is linear if a plot of phase shift versus frequency is a straight line using analog scales. Deviation from linear phase causes signal distortion.

Digital: Pertaining to the class of devices or circuits in which the output varies in discrete steps.

Digital demodulation: Describes a technique of extracting the information used to modulate a signal. Digital signal processing algorithms are used on the signal after it has been converted from an analog to a digital form (digitized).

Dimension: To specify the size of an array. The number of array rows or columns.

Directional coupler: A 3-port device typically used for separately sampling the backward (reflected) wave in a transmission line.

Directivity: In a 3-port directional coupler, the ratio of the power present at the auxiliary port when the signal is traveling in the forward direction to the power present at the auxiliary port when the same signal is traveling in the reverse direction.

Disk: A circular, magnetic storage medium.

Display: Noun: The physical surface of the CRT. See also screen. Verb: To show annotation and measurement data on the CRT.

Display detector mode: The manner in which analog, video information is processed prior to being digitized and stored in memory.

Display dynamic accuracy: The amplitude uncertainty, usually in dB, over the display dynamic range.

Display dynamic range: The amplitude range, in dB, over which the display dynamic accuracy applies.

Display formats: Graphical formats for displaying measurement data. These include single channel, dual channel overlay (two traces on one graticule), dual-channel split (each trace on separate graticules)

Display modes: The ways in which measurement data can be presented graphically. On a network analyzer, the choices are Cartesian/rectilinear (XY plot with log or linear magnitude, phase, group delay, SWR, real and imaginary, and dBV, dBmV and dBuV), polar (magnitude and angle), magnitude and phase, and Smith chart. Not all display modes are available on all network analyzers. In addition, displays can present this information in various combinations of traces. Common modes are dual, (the ability to display more than one trace, usually over the same frequency range), and alternate, (the ability to display more than one trace, each with different frequency range and type).

Display phase dynamic accuracy: The phase measurement uncertainty, usually in degrees, for measurements whose units are in degrees.

Display points: The total number of measurement points made in a single measurement. The points can be in units of frequency, power, or time. The number of points often dictates measurement speed, resolution, and aperture.

Display trace noise, magnitude: The amplitude uncertainty of the trace, in dB, due to random noise in the test system.

Display trace noise, phase: The phase uncertainty of the trace, in degrees, due to random noise in the test system.

Display type: The type of display screen built into the analyzer. Data can be displayed as a raster drawing (a computer-like dot map) or as a vector drawing (lines drawn on the CRT). Color and display standard can also be specified as monochrome (single color), or color (two or more colors). The format standard may also be specified, such as VGA or SVGA, for IBM-compatible personal computers.

Distortion: Deterioration of a signal's quality due to the nonlinear characteristics of a device or system transfer function. Distortion is measured as a combination of the changes in amplitude, frequency and phase of signal at the output of a device or system as compared to the signal at the input.

Drift: The slow change in signal frequency.

DSP: Digital Signal Processing

DUT: Device Under Test.

DVM: Digital Volt Meter

Dynamic range: In a receiver, the range of signal levels, from minimum to maximum, that can be reliably measured simultaneously. Dynamic range allows small signals to be measured in the presence of large signals. Source power and receiver compression usually limits the maximum boundary to dynamic range. Receiver residual responses and noise floor usually limit the minimum power boundary.

E

Ecal: See electronic calibration.

Electrical delay: A simulated variable length of lossless transmission line, added to or subtracted from a receiver input, to compensate for interconnecting cables. The firmware equivalent of mechanical or analog "line stretchers" in other network analyzers.

Electronic calibration (Ecal): A calibration system for electronic calibration of RF and microwave vector network analyzers. The HP 85060 electronic calibration system creates a twelve-term, two-port error model and then provides a confidence check of the calibration. The Ecal system consists of a repeatable, variable-impedance, solid-state calibration standard and a mainframe control unit which interfaces with the HP 8510, 8720 series, and the 8753 network analyzers.

EMC: Electro-Magnetic Compatibility

EMI: Electro-Magnetic Interference: Unintentional interfering signals generated within or external to electronic equipment. Typical sources could be power-line transients, noise from switching-type power supplies and/or spurious radiation from oscillators. EMI is suppressed with power-line filtering, shielding, etc.

Engage: To activate a function.

Enter: The process of inputting information.

EPROM: Electronically Programmable, Read-Only Memory.

Error correction: In network analyzers, a process that removes or reduces systematic (repeatable) measurement errors by measuring known standards from a calibration kit. Synonym: Measurement calibration

Error correction, 1-port: Corrects a test set for port 1 or port 2 directivity, frequency response, and source match errors. The process requires three known standard terminations, for example, open, short, and load.

Error correction, 12-term: Correction for a two port device using six parameters: Directivity, Source match, Load match, Reflection frequency response, Transmission frequency response, isolation. To completely characterize a two-port device, these six parameters must be characterized in the forward and reverse directions, making a total of 12 terms. The user usually has the option of omitting isolation from the correction process. Synonym: Full two-port error correction.

Error correction, 15-term: 12-term error correction with the addition of three terms representing previously corrected source match.

Error correction, 3-term: Used to remove systematic measurement errors on a device with one port, such as a load

Error message: A message on a display that indicates an error condition. Missing or failed hardware, improper user operation, or other conditions that require additional attention can cause an error condition. Generally, the requested action or operation cannot be completed until the condition is resolved.

ESD: Electro Static Discharge

Ethernet: A network that adheres to the IEEE 802.3 Local Area Network standard.

Ethernet address: A hexadecimal number which is used to identify a machine on a network. Each analyzer is assigned a unique Ethernet address at the factory and it is stored in the analyzer's ROM.

Ethertwist: See 10Base-T

External trigger signal: A TTL signal that is input to an analyzer and initiates a measurement sweep or similar event, making the measurements synchronous with the external triggering source.

F

Filter: Passive device that allows some frequencies to pass and attenuates others, depending on the type and specifications. A high-pass filter passes frequencies above the cutoff frequency, a low-pass filter passes frequencies below the cutoff frequency, and a band-pass filter passes frequencies between two specific frequencies.

Firmware: An assembly made up of hardware and instruction code. The hardware and instruction code is integrated and forms a functional set that cannot be altered during normal operation. The instruction code, permanently installed in the circuitry of the instrument, is classified as ROM (read only memory). The firmware determines the operating characteristics of the instrument or equipment.

Flatness: The amplitude and phase response of a device under test (DUT), a signal source, a receiver, or a combination of these. See also frequency response.

FM: Frequency modulation

Frequency: The number of periodic oscillations, vibrations, or waves per unit of time, usually expressed in cycles per second, or Hertz (Hz).

Frequency accuracy: The uncertainty with which the frequency of a signal or spectral component is indicated, either in an absolute sense or relative to another signal or spectral component. Absolute and relative frequency accuracies are specified independently.

Frequency range: The range of frequencies over which a device or instrument performance is specified. The maximum frequency range of many microwave spectrum analyzers can be extended with the application of external mixers.

Frequency resolution: The ability of a spectrum analyzer to separate closely spaced spectral components and display them individually. Resolution of equal amplitude components is determined by resolution bandwidth. Resolution of unequal amplitude signals is determined by resolution bandwidth and bandwidth selectivity.

Frequency response: The peak-to-peak variation in the displayed signal amplitude over a specified center frequency range. Frequency response is typically specified in terms of dB, relative to the value midway between the extremes. It also may be specified relative to the calibrator signal.

Frequency span: The magnitude of the displayed frequency component. Span is represented by the horizontal axis of the display. Generally, frequency span is given as the total span across the full display. Some analyzers represent frequency span (scan width) as a per-division value.

Frequency stability: The ability of a frequency component to remain unchanged in frequency or amplitude over short and long-term periods of time. Stability refers to an oscillator's ability to remain fixed at a particular frequency over time.

Front panel key: Keys that are located on the front panel of an instrument. The key labels identify the function the key activities. Numeric keys and step keys are two examples of front panel keys.

Full 2-port calibration: See calibration, 2-port

Function: The action or purpose that a specific item is intended to perform or serve. The spectrum analyzer contains functions that can be executed via front panel key selections, or through programming commands. The characteristics of these functions are determined by the firmware in the instrument. In some cases, a DLP (downloadable program) execution of a function allows you to execute the function from front panel key selections.

Fundamental frequency: In any waveform, the lowest frequency component; all other components are harmonics. A pure sinusoid has only one component, the fundamental.

G

Gb: Gigabit

GHz: Gigahertz

GIF: Graphics Interchange Format - Standard graphic format to store bitmapped graphics files.

Giga: Prefix for one billion

GP I/O: General Purpose Input / Output; a connector usually on the back of an instrument that allows communication with other test equipment, external test sets, switches, and computers that enable the instrument to be triggered or to trigger external equipment. An example is a foot switch that continues or cycles a measurement, allowing the operator to use both hands on the test hardware.

GPIB: General Purpose Interface Bus - IEEE 488 bus is interconnect bus and protocol, allows linking of instruments and computer.

Graticule (or Grid): Enclosed area where waveform is displayed on instrument. Tick marks, on frame or axis, are a scaling aid for making visual measurements.

Group delay: A measure of the transit time of a signal through a DUT versus frequency. Group delay can be calculated by differentiating the DUT's insertion-phase response versus frequency. See also AM group delay and deviation from linear phase.

GUI: Graphical User Interface

H

Hardcopy: Paper copy of data.

Hardkey: A front-panel key, which engages a single analyzer function or presents a single menu of softkeys.

Horizontal reference: See Reference Level

Horizontal resolution: The analyzer's ability to take closely space horizontal data points over the full sweep.

Host computer: A computer or device on a network that provides end users with services such as computation and database access and that usually performs network control functions.

Host name: A unique name that is used to identify each host machine on a network. The host name is directly linked to, and can usually be used in place of the IP address. The user or the system administrator usually creates the host name.

HP: Hewlett-Packard Company

HP-IB: Hewlett-Packard Interface Bus. A parallel interface that allows "daisy chaining" of more than one device to a port on a computer or instrument. Interface protocol is defined in IEEE 488.2; equivalent to the industry standard GPIB.

HPGL: Hewlett-Packard Graphics Language

HTTP: HyperText Transfer Protocol: Used to carry World Wide Web (WWW) traffic.

Hue: The dimension of color referred to a scale of perceptions ranging from red through yellow, green, and blue, and back to red. A particular gradation of color, tint, shade.

I

I/O: Input/Output

I/O Path: Input/output path.

IEEE: Institute of Electrical and Electronic Engineers

IF: Intermediate Frequency: the frequency at which a signal is processed after mixing. See also superheterodyne

Impedance: The ratio of voltage to current at a port of a circuit, expressed in ohms.

Initialize: The process that assigns information locations to a disk to prepare the magnetic media to accept files.

Input: A path intended for putting a signal into an instrument. Most network analyzers have either 3 (labeled A, B, and R) or 4 inputs (labeled A, B, R1, and R2). Inputs are not the same as channels.

Input attenuator: An attenuator between the input connector and the first mixer of a spectrum analyzer (also called an RF attenuator). The input attenuator is used to adjust the signal level incident to the first mixer, and to prevent gain compression due to high-level or broadband signals. It is also used to set the dynamic range by controlling the degree of internally-generated distortion. For some spectrum analyzers, changing the input attenuator settings changes the vertical position of the signal on the display, which then changes the reference level accordingly. In Hewlett-Packard microprocessor-controlled spectrum analyzers, the IF gain is changed to compensate for changes in input attenuator settings. Because of this, the signals remain stationary on the display, and the reference level is not changed.

Insertion Loss: The difference between the power measured before and after the insertion of a device. The attenuation between the input and output of a device.

Intensity: Brightness; emitting or reflecting light; luminosity.

Interface: A connection that allows a common communication link between two or more instruments.

Intermodulation distortion: Undesired frequency components resulting from the interaction of two or more spectral components passing through a device having nonlinear behavior, such as a mixer or an amplifier. The undesired components are related to the fundamental components by sums and differences of the fundamentals and various harmonics. The algorithm is: $f_1 \pm f_2$, $2f_1 \pm f_2$, $2f_2 \pm f_1$, $3f_1 \pm 2f_2$, and so on

Internet: The connection of two or more distinct networks. Often a gateway or router is used to make the connection.

Interpolate: To determine a value of a signal between two adjacent points by a procedure or algorithm.

IP: internet Protocol

IP address: Internet protocol address: a unique number that is assigned to each device which is to be connected to a TCP/IP network. Before using an analyzer on a network, your network administrator will need to assign an IP address. An IP address consists of a 32-bit value presented in decimal dot notation: 4 octets (bytes) separated by a dot.

ISDN: Integrated Services Digital Network: A standard digital service capability that features one or more circuit-switched communication channels capable of carrying digital voice, data, or image signals, a packet-switched channel for out-of-band signaling and control. In addition, ISDN provides a collection of standard and optional features that support information productivity for the user providing higher-speed Internet access than analog systems.

ISO: International Standards Organization

Isolation: A specification or measure of the immunity that one signal has to being effected by another adjacent signal. The occurrence is known as crosstalk.

Isolator: An RF device used for providing isolation between paths and components. Made from 3-port circulator, the third port being terminated in a 50ohm load.

K

KB: Kilobyte

Kbs: Kilobytes per second

Kilo: Prefix for one thousand

L

LAN: Local Area Network

LANS: Local Area Network System

LCD: Liquid Crystal Display

LED: Light Emitting Diode

LIF: Logical Interchange Format (used for older HP disk drives/computers)

Limit lines: Lines input by the user that overlay the analyzer's measurement data to allow automatic detection of data that is out of the acceptable range. Pass/Fail annotation, audio alarms, or electronic output can be triggered to notify the operator or on-line computer program of the over-limit condition.

Limit-line file: The user-memory file that contains the limit-line table entries.

Limit-line table: The line segments of a limit line are stored in the limit-line table. The table can be recalled to edit the line segments, then restored in the limit-line file.

Linear Device: A device in which the output is continuously proportional to the input.

LO: Local Oscillator. In a superheterodyne system, the LO is mixed with the received signal to produce a sum or difference equal to the intermediate frequency (IF) of the receiver.

LO feedthrough: The response that in a superheterodyne system when the first local oscillator frequency is equal to the first IF. In spectrum analyzers, the LO feedthrough is a 0 Hz marker with no error, so it can be used to improve the frequency accuracy of spectrum analyzers with nonsynthesized LO systems.

Load: A one port microwave device used to terminate a path in its characteristic impedance.

Load match: A measure of how close the device's terminating load impedance is to the ideal transmission line impedance. Match is usually measured as return loss or standing wave ratio (SWR) of the load. NEED SOMETHING ABOUT LOAD MATCH ERROR.

Local Lock Out: A condition or command that prevents analyzer front-panel entries (and disables the ~ key).

Local Operation: To operate manually from the front panel.

Log: Logarithm.

Log display: The display mode in which vertical deflection is a logarithmic function of the input signal voltage. Log display is also called logarithmic display. The display calibration is set by selecting the value of the top graticule line (reference level), and scale factor in volts per division. On spectrum analyzers, the bottom graticule line represents zero volts for scale factors of 10 dB/division or more. The bottom division, therefore, is not calibrated for those spectrum analyzers. Spectrum analyzers with microprocessors allow reference level and marker values to be indicated in dBm, dBmV, dBpV, volts, and occasionally in watts. Spectrum analyzers not based upon microprocessors usually offer only one kind of unit (typically dBm).

LRM: Line-Reflect-Match. See calibration TRL and LRM.

M

Magnitude: The amplitude of a signal measured as a voltage in its characteristic impedance without regard to phase. See also Scalar.

Marker: A graphical symbol along a display trace that is annotated with measurement characteristics of that specific data point.

Marker functions: Mathematical or statistical computation on the data of one or more markers to provide the operator more information. Example: a marker average function that converges the noise variations to provide a more stable marker amplitude reading.

Maximum input level: The maximum signal power that may be safely applied to the input of an analyzer. The maximum input level is typically 1 W (-30 dBm) for Hewlett-Packard spectrum analyzers.

MB: Megabyte

Measurement uncertainty: The quantified amount of error in a measurement situation. Calibrations are intended to reduce the amount of uncertainty. The following are sources of measurement errors that lead to uncertainty: * Systematic errors (imperfections in calibration standards, connectors, cables, and instrumentation) * Random errors (noise, connector repeatability) * Drift (source and instrumentation)

Mega: Prefix for one million

Memory: A storage medium, device, or recording medium into which data can be stored and held until some later time, and from which the entire original data may be retrieved.

Memory card: A small memory device shaped like a credit card that can store data or programs. The programs are sometimes called personalities and give additional capabilities to your instrument. Typically, there is only one personality per memory card. Refer also to personality.

Menu: The analyzer functions that appear on the display and are selected by pressing front panel keys. These selections may evoke a series of other related functions that establish groups called menus.

MHz: Megahertz

milli: Prefix for one-thousandth

Modem: Modulator/Demodulator

Modulation: The process, or the result of the process, of varying a characteristic of a carrier signal with an information-bearing signal, causing the carrier to contain the information. See AM and FM

Monitor: Any external display.

Monochrome: Having only one color (chromaticity).

ms: Millisecond: one thousandth of a second

Multisync: A type of monitor that can synchronize its horizontal sweep to various frequencies within a specified range.

mW: Milliwatt: one thousandth of a watt

N

Narrowband: In network analysis, the frequency resolution of the analyzer's receiver that is sufficiently narrow to resolve the magnitude and phase characteristics of narrowband devices. The reduced receiver bandwidth usually decreases the noise floor of the receiver, providing more measurement amplitude range.

Narrowband device: A device whose transfer characteristics are intended to operate over a very narrow frequency range and are designed to provide well-defined amplitude responses in that range, such as a band pass filter.

NBus: One or more conductors used as a path to deliver transmitted information from any of several sources to any of several destinations.

Network analysis: The characterization of a device, circuit, or system derived by comparing a signal input going into the device to a signal or signals coming out from the device.

NIST: National Institute of Standards and Technology

Nit: The unit of luminance (photometric brightness) equal to one candela per square meter.

Noise: Random variations of unwanted or disturbing energy in a communications system from man-made and natural sources that affects or distorts the information carried by the signal. See also signal-to-noise ratio.

Noise figure: (NF): For a two-port device, a measure of how the noise generated inside the device degrades the signal-to-noise ratio of a signal passing through the device at 290 degrees, usually expressed in dB.

Noise floor: The analyzer's internal displayed noise. The noise level often limits how small a signal magnitude can be measured. In network analysis, noise floor is measured with the test ports terminated in loads, full two-port error correction, 10 Hz IF bandwidth, maximum test port power, and no averaging during the test.

Nonvolatile memory: Memory data that is retained in the absence of an ac power source. This memory is typically retained with a battery. Refer also to battery-backed RAM.

Normalize: To subtract one trace from another to eliminate calibration data errors or to obtain relative information.

O

Offset: To move or set off a determined amount. Used in instruments for offsetting frequencies, limits, delay, loss, impedance, etc.

Output attenuation: The ability to attenuate the signal from port 1, the source, in order to control its power level.

P

Parser: Reads program messages from the input queue of a device in the order they were received from the controller. The parser determines what actions the analyzer should take. One of the most important functions of the command parser is to determine the position of a program message in the analyzer SCPI command tree. When the command parser is reset, the next element it receives is expected to arise from the base of the analyzer command tree.

PC: Personal Computer

PDF: Portable Document Format (used on the Web)

Peak search: A function on an analyzer that searches for the largest signal and places a marker on it.

Phase: The fractional part of a cycle through which an oscillation has advanced, measured from an arbitrary starting point; usually measured in radians or degrees. In network analysis, the phase response of the device under test is the change in phase as a function of frequency between the input stimulus and the measured response.

Port: The physical input or output connection of an instrument or device.

Positive peak: The maximum, instantaneous value of an incoming signal. On digital displays, each displayed point of the signal indicates the maximum value of the signal for that part of the frequency span or time interval represented by the point.

Postscript (.ps files): Stores bitmapped graphics files in an encapsulated format for direct use by postscript printers.

Power, max input: The upper limit to input power for which the specifications apply. Some specifications may have different levels of maximum inputs. For example, compression power maximum is usually higher than the harmonic distortion maximum.

Power, safe input: The input power, usually in dBm, allowed without damaging the instrument.

Preset: A pre-defined instrument state (that also runs an analyzer self-test). The action of pushing the preset key.

Protocol: A set of conventions that specify how information will be formatted and transmitted on a network, and how machines on a network will communicate.

Q

Q or Q factor: The ratio of energy stored to energy lost in a resonant circuit. High Q indicates a sharp resonance response over frequency

Query: Any analyzer programming command having the distinct function of returning a response. These commands may end with a question mark (?). Queried commands return information to the computer.

R

r + jx: Expression for complex impedance, where r represents the resistive portion and x represents the reactive portion.

R channel: Reference channel

RAM: Random Access Memory, or read-write memory: A storage area allowing access to any of its storage locations. Data can be written to or retrieved from RAM, but data storage is only temporary. When the power is removed, the information disappears. User-generated information appearing on a display is RAM data.

Receiver: A circuit or system designed for the reception and/or measurement of signals in a specified frequency spectrum.

Receiver dynamic range: See Dynamic range

Reference level: An instrument function that allows the user to set the amplitude value at the reference position. On network analyzers, the reference position is also selectable. On spectrum analyzers, the reference position is fixed at the top of the display.

Reference plane: The electrical location at which a network analyzer is calibrated. The closer the reference plane is to the device under test (DUT), the better the characterization of the device because of the elimination of test system uncertainties.

Reflection: The phenomenon in which a traveling wave strikes a discontinuity and returns to the original medium.

Reflection coefficient: The ratio of the reflected voltage to the incident voltage into a transmission line or circuit. If a transmission line is terminated in its characteristic impedance, the reflection coefficient is zero. If the line is shorted or open the coefficient is 1. See also Return Loss and SWR.

Reflection measurements: Measurements that characterize the input and /or output behavior of the device under test (DUT). Measured as the ratio of the reflected signal to the incident signal as a function of frequency. Parameters are called return loss, reflection coefficient, impedance, and standing wave ratio (SWR), all as a function of frequency. See also S-Parameters.

Remote: A mode of operation where another device (or computer) controls an instrument via the HP-IB. In this mode, the instrument front panel keys are disabled. Front panel operation is called local operation

Remote programming: The automatic operation of an instrument by a computer, usually through a HP-IB or RS-232 link.

Resolution: The ability of a receiver to resolve two signals.

Resolution bandwidth: The ability of a spectrum analyzer to display adjacent responses discretely (hertz, hertz decibel down). This term is used to identify the width of the resolution bandwidth filter of a spectrum analyzer at some level below the minimum insertion loss point (maximum deflection' point on the display). Typically, it is the 3 dB resolution bandwidth that is specified, but in some cases the 6 dB resolution bandwidth is specified.

Return loss: The amount of dB that the reflected signal is below the incident signal. If zero signal is reflected, the impedance of the device is equal to the characteristic impedance of the transmission system, and return loss is infinite. If the entire incident signal is reflected, the return loss is zero. See also S-parameters, reflection coefficient, and SWR.

Reverse measurement: The measurement of a device from output to input.

RF: Radio Frequency (from approximately 50 kHz to approximately 3 GHz). Usually referred to whenever a signal is radiated through the air.

ROM: Read Only Memory: A storage area that can be read only; it cannot be written to or altered by the user. In instruments, the storage area that contains the "brains" or operational programming; the firmware.

S

S-parameters (scattering parameters): A convention used to characterize the way a device modifies signal flow using a network analyzer. A two port device has four S-parameters: forward transmission (S₂₁), reverse transmission (S₁₂), forward reflection (S₁₁), and reverse reflection (S₂₂)

S/N: Signal-to-noise ratio

Sampler: An electronic component that captures the signal level and phase across a known impedance at a uniform rate. In Network Analyzers, this sampling rate must be sufficiently high and precisely timed to make accurate measurements. Network analyzers typically have three or four samplers.

Sampler Bounce: The leakage or crosstalk between a network analyzer's samplers. Delay in this crosstalk caused by leakage transmission propagation, give the interference its "bounce" appearance. Sampler bounce causes an increase in the noise level of the affected channel, reducing the sensitivity of the analyzer.

Saturation: The degree of color purity, on a scale from white to pure color.

Scalar: A quantity that has magnitude but no phase. A network analyzer capable of measuring only magnitude.

Scale factor: The display vertical axis calibration in terms of units per division.

SCPI: Standard Commands for Programmable Instruments.

Screen: The physical surface of the CRT or flat panel upon which the measurement results, setup information, softkey definitions, and other instrument communication is presented.

Self-Test: A group of tests performed at power-up (or at preset) that verify proper instrument operation.

Sensitivity: The minimum input signal required to produce a specified output signal having a specified signal-to-noise ratio, or other specified criteria. On a spectrum analyzer, the level of the smallest sinusoid that can be observed, usually under optimized conditions of minimum resolution bandwidth, 0 dB input attenuation, and minimum video bandwidth. The normalized change in YIG component's center frequency resulting from a change in tuning coil current, specified in MHz/mA.

Serial prefix: The five-character prefix that begins an instrument serial number; used to represent versions of firmware or hardware changes that have occurred.

Server: A device that is configured to provide a service to other devices on a network, such as shared access to a file system or printer.

Signal-to-noise ratio: SNR: The ratio of the amplitude of the desired signal to the amplitude of noise signals, usually expressed in dB and in terms of peak values for impulse noise and root-mean-square values for random noise.

Single sweep mode: The spectrum analyzer sweeps once when trigger conditions are met. Each sweep is initiated by pressing an appropriate front panel key, or by sending a programming command.

Small signal gain compression: A situation when the input signal's measured amplitude is less than its actual level due to overloading of the network analyzer's input mixer; the analyzer is operating nonlinearly. For broadband analyzer detectors, a signal other than the one under test can put the analyzer into this gain compressed mode, thereby making even lower level signals appear at a lower level than actual. The broadband mode measures all the power incident to the analyzer, not just the signals at the frequency of interest.

Smith chart: A graphical mapping of the complex reflection coefficient into normalized complex impedance. Circles on the chart represent constant resistance and radiating lines orthogonal to the circles represent constant reactance. The center of the chart represents the characteristic impedance of the transmission system. Any point on the chart defines a single complex impedance. A line on the chart represents changing impedance over frequency.

SOLT: Source-Open-Load-Through calibration. See also calibration, SOLT.

Source: A device that supplies signal power; a sweep oscillator or synthesized sweeper.

Source amplitude accuracy: The amplitude uncertainty, in dB, of the source power readout.

Source amplitude flatness: The amplitude flatness, in dB, of the source power over the frequency range specified.

Source frequency resolution: The smallest unit of frequency which can be set and/or measured, in Hz.

Source frequency time base accuracy: A measure of the analyzer's frequency stability measured in parts per million (ppm. or 1 part in 10E6). For example, a stability of ± 5.0 ppm means that an analyzer will measure 1 MHz to an accuracy of $\pm 5 \times 10^{-6} \times 10E6$ Hz = ± 5 Hz.

Source frequency time base stability: A measure of the analyzer's time base accuracy over time and temperature. Typically the time base accuracy will be specified for 1 year. A typical temperature frequency stability is ± 10 ppm for 250 C \pm 50 C.

Source harmonics: The level of harmonics generated by the analyzer's signal source, in dBc from the fundamental.

Source match: A measure of how close the signal source impedance is to the ideal transmission line impedance of the test system. Match is usually measured as return loss or standing wave ratio (SWR) of the source.

Span: The stop frequency minus the start frequency. The span setting determines the horizontal-axis scale of the analyzer display.

Span accuracy: The uncertainty of the indicated frequency separation of any two signals on the display.

Step: The increment of change that results when you press the front panel step keys, \sim and \sim , or by program commands.

Stop/start frequency: Terms used in association with the stop and start points of the frequency measurement range. Together they determine the span of the measurement range.

Storage states: The number of settings, programs, traces, and other parameters available to be saved, cataloged, and recalled at any one time.

Storage, disk: n internal or external digital storage disk for saving test data, instrument settings, IBASIC programs, and other measurement parameters. Storage formats include MS-DOS (R) and HPs standard LIF with binary, PCX, I-IP-GL, or ASCII data formats.

Structural return loss: Poor return loss in cable due to a periodic fault such as a periodic dent caused by dropping the cable spool or by the cable pulling process during manufacture.

Supplemental characteristics: Typical but non-warranted performance parameters, denoted as "typical", "nominal" or "approximate".

Sweep: The ability of the source to provide a specified signal level over a specified frequency range in a specified time period. Also see sweep mode and type. In data processing mode, a series of consecutive data point measurements, taken over a sequence of stimulus values.

Sweep mode: The way in which a sweep is initiated or selected, e.g., single, continuous, alternate, or chopped.

Sweep type: The method of sweeping the source, e.g., linear, log, or frequency step.

Sweeper: A signal source that outputs a signal that varies continuously in frequency.

SWR: tanding wave ratio, calculated as $(1 + p) / (1 - p)$ where p is the reflection coefficient.

Sync: Synchronization, or synchronized.

Syntax: The grammar rules that specify how commands must be structured for an operating system, programming language, or applications.

System dynamic range: The difference between the maximum receiver input level and the receiver's noise floor. System dynamic range applies to transmission measurements only, since reflection measurements are limited by directivity.

T

T/R: See transmission / reflection

TDR: See time domain reflectometer

Termination: A load connected to a transmission line or other device.

Test limit: The acceptable result levels for any given measurement.

Test port: See port.

Test set: The arrangement of hardware (switches, couplers, connectors and cables) that connect a test device input and output to the network analyzer's source and receiver to make s-parameter measurements.

Third order intercept: TOI: The power input to a non-linear device that would cause third order distortion at the same power level. TOI is a measurement to determine the distortion characteristics of a mixer or receiver. The higher the value, the more immune the receiver to internal distortion.

Thru: Through line: A calibration standard. See calibration, SOLT

Tint: A shade of color; hue.

Toggle: To switch states, usually to change a function from on to off, or off to on.

TOM: Thru-Open-Match: A Rohde&Schwarz term to describe a calibration method.

Trace: A series of data points containing frequency and amplitude information. The series of data points is often called an array. Traces A, B, and C are the typical names of traces that the analyzer displays. The number of traces is specific to the instrument.

Tracking: The ability of the analyzer's receiver to tune to the source frequency over the measurement frequency range. Poor tracking results in amplitude and phase errors due to the receiver IF circuits attenuating and delaying the device under test output.

Transfer function: The ratio of the output signal to the stimulus signal, both as a function of frequency.

Transmission: See transmission measurements

Transmission intermodulation spurious: A measure of the capability of the transmitter to inhibit the generation of intermodulation distortion products. Intermodulation spurious is sometimes called intermodulation attenuation.

Transmission measurements: The characterization of the transfer function of a device, that is, the ratio of the output signal to the incident signal. Most common measurements include gain, insertion loss, transmission coefficient, insertion phase, and group delay, all measured over frequency. See also s-parameters.

Transmission/reflection (T/R): Refers to the suite of measurements made by a scalar or vector network analyzer to characterize a device's behavior over frequency. See also s-parameters.

Transparent: Something that is not visible to the user. Usually a procedure that occurs without the user's initiation or knowledge.

Trigger: A signal that causes the instrument to make a measurement. The user can select several options for triggering, such as manual, continuous, or external (for synchronizing measurements to an external source).

TRL: Through-Reflect-Line. See calibration TRL and LRM

TTL: Transistor-Transistor Logic

Two-port error correction: See error correction, 12-term

U

Uncorrected: Measurements made without performing error correction.

Uncoupled channels: Stimulus or receiver settings allowed to be set independently for each channel.

UNI: User-Network Interface: The point at which users connect to the network.

Units: Dimensions on the measured quantities. Units usually refer to amplitude quantities because they can be changed. In analyzers with microprocessors, available units are dBm (dB relative to 1 mW dissipated in the nominal input impedance), dBmV (dB relative to 1 mV), dBW (dB relative to 1 W), V (volts), W (watts).

V

Variable: A symbol, the value of which changes either from one iteration of a program to the next, or within each iteration of a program.

Vector: A quantity that has both magnitude and phase. A network analyzer capable of measuring both magnitude and phase.

VEE: Visual Engineering Environment (HP software product)

Velocity factor: A numerical value related the speed of energy through transmission lines with different dielectrics (.66 for polyethylene) Used in making time domain measurements.

Vertical Resolution: The degree to which an instrument can differentiate amplitude between two signals.

Video: An electrical signal containing timing, intensity, and often color information that, when displayed, gives a visual image.

Video bandwidth: The cutoff frequency (3 dB point) of an adjustable low-pass filter in the video circuit. When the video bandwidth is equal to or less than the resolution bandwidth, the video circuit cannot fully respond to the more rapid fluctuations of the output of the envelope detector. The result is a smoothing of the trace, or a reduction in the peak-to-peak excursion, of broadband signals such as noise and pulsed RF when viewed in broadband mode. The degree of averaging or smoothing is a function of the ratio of the video bandwidth to the resolution bandwidth.

Video filter: A post-detection, low-pass filter that determines the bandwidth of the video amplifier. It is used to average or smooth a trace. Refer also to video bandwidth.

VNA: Vector Network Analyzer

W

Waveform: A representation of a signal plotting amplitude versus time.

Wireless: A term that refers to a broad range of technologies that provide mobile communications for home or office, and "in-building wireless" for extended mobility around the work area, campus, or business complex. It is also used to mean "cellular" for in-or out-of-building mobility services.

WWW: World Wide Web

Z

Zero-length thru (path): In a measurement calibration, when the two test cables mate together directly without using adapters or a thru-line. See also Non-insertable devices.

Index

- .
- .csa - .cst - .sta - .cal files** 321
- .cti files 333
- .mdf files 335
- .s1p - .s2p - .s3p files 328
- .xml files** 882, 1023, 1030
- 2**
- 2-port devices reflection accuracy 108
- 3**
- 3-Port error terms 227
- 3-port SOLT calibration 129
- 4**
- 4-port Cal using 2-port ECal 183
- 4-port embed-deembed** 204
- 4-port error terms 227
- 8**
- 82357A 956
- 8510 cal kits - importing** 248
- 8510 data processing mode 297
- A**
- about Network Analyzer 30
- absolute output 1046
- absolute output power 1046
- accessories- list of 950
- accessories, effects of 118
- accuracy of calibration 231
- accuracy, on low-loss 2-port devices 108
- accuracy, phase measurements 103
- accuracy, reflection 108
- accurate measurement calibrations 231
- active channel 12
- active data trace 296
- adapter removal cal - ECal 237
- adapter removal cal - mechanical stds 235
- adapters - using to calibrate 234
- add users 1
- address - GPIB 852
- adjust the display 81
- administrator - user 1
- administrator password 1
- admittance chart 75
- all off 87
- alternate sweep, crosstalk 117
- amplifier parameters 1048
- analyzer specifications 1076
- annotation - display 81
- antivirus protection 4
- aperture, group delay 1068
- app notes 1033
- application crashes 892
- applying cal sets 153
- arbitrary impedance 261
- arbitrary ratio 37
- arbitrary segment sweep 57
- arbitrary Z standard 242
- archiving cal sets 158
- ASCII file types 328
- assignments - cal class 266
- auto port ext.** 215
- auto save 320
- autocheck 958
- auxiliary trigger 65
- averaging, sweep 113
 - how to set 113
- B**
- balanced measurements 1050
- bandwidth 273
- binary file types** 326
- block diagram - configurable test set 1076
- block diagram - standard test set 1076
- boot from the recovery partition 3
- C**
- cables - how to ground 1045
- cal all channels 145
- cal kit manager 246
- cal set viewer 229

- cal sets 152
- calibration kits 242
 - creating 254
 - databased 232
 - modifying 246
 - waveguide 258
- calibration select 129
- calibration standards - measuring 238
 - accurate 231
 - cal set 152
 - Cal Wizard 132
 - class assignments 266
 - data-based model 232
 - electronic (ECal) 163
 - enhanced response** 130
 - instrument calibration and verification 960
 - isolation (crosstalk) 117
 - model 232
 - non-insertable device 234
 - overview 219
 - polynomial model 232
 - power calibration 188
 - select a, 129
 - standards 242
 - types 129
 - using thru adapters 234
 - validity of, 238
 - window 132
- care of connectors 1036
- channel settings 12
- channels - copy 96
- channels - traces and windows 8
- citifiles 333
- class assignment 244
- class assignments - modify 266
- classes calibration - about 244
- classes-measurement 34
- clean connectors 1041
- coefficient, transmission** 1093
- common mode 1050
- compensating for test fixture 200
- complex impedance 1049
- conductive table mat 1045
- confidence check 239
- configure an external device 986, 990
- configure an external LO source 986, 990
- configure for GPIB-SICL 860
- connectivity 24
- connector care 1036
- connector repeatability 222
- continuous** 62
- copy channels 96
- corrected system performance - specifications 1076
- correction level 160
- correction ON/off 160
- corrupted operating system 3
- counter averaging 113
- coupled markers 273
- coupling between ports** 47
- crash - VNA 892
- creating windows 13
- crosstalk specification 1076
- crosstalk, receiver 117
- cti files 333
- customize your analyzer screen 81
 - status bar** 87
 - tables 84
 - title bars 87
 - toolbars 85
- CW time sweep 51
- D**
- data display 72
- data processing - 8510 mode 297
- data saving 335
- data trace display 296
- data transfer speed 124
- data transfer time 1076

- data transfer time - specifications 1076
- data-based model for calibration 232
- default conditions 32
- define data saves 335
- definitions 1076
- definitions - specs 1076
- delay functions 1059
- delay, electrical 103
- delay, group 1066
 - accuracy considerations 1069
 - aperture, what is 1068
 - what is 1066
 - why measure 1067
- delta marker** 272
- detector inputs - specifications 1076
- linear phase 1061
- deviation from linear phase 1048, 1061
 - accuracy considerations 1062
 - using electrical delay 1061
 - what is 1061
 - why measure 1061
- device connections 112
- device delay 106
- device-side USB 873
- dielectric - velocity factor** 103
- differential mode 1050
- dimensions-physical 1076
- directivity error 222
- disaster recovery partition 3
- discrete marker** 272
- display 81
- display formats 72
- display specifications 1076
- display test 974
- documentation - VNA 28
- documentation warranty 29
- domain 290
- drift 111
 - errors 221
 - frequency 111
 - temperature 111
- DSP Number 30
- dwelt time - segment sweep 52
- dwelt time - stepped sweep** 59
- dynamic accuracy specification 1076
- dynamic range 101
- E**
- E5092ATestset 1006
- ECal 163
 - 4-port Cal using 2-port ECal 183
 - confidence check 239
 - models 951
 - procedure 164
 - thru methods 237
 - user-characterization 170
- edge triggering** 66
- editor - equation 301
- effects of accessories 118
- electrical delay 103
- electrical delay, using 1061
- electrically-long device measurements 106
- electronic calibration (ECal) 220
- electrostatic discharge protection 1045
- embed and De-Embed a fixture 200
- EMI specification 1076
- enhanced response cal** 130
- environment specifications 1076
- equal length adapter method 217
- equation editor 301
- erase memory 22, 1019
- error correction 160
 - no correction 161
 - potential degradation 161
 - validation calibration accuracy 238
- error messages - about 947, 1012
- error messages - list of 895
- error terms - 4 port 227
- error terms-monitoring 229

errors, measurement 221
errors, random 221
errors, systematic 221
ESD protection 1045
event log 892
examples of cal set usage 157
examples-programming 343, 885
excursion 278
execute 274
expanded math 267
extensions, port 232
external CD-RW drive, save file to 320
External Device 986, 990
external source configuration 987, 990
external trigger 65
F
factor - velocity 103
file recall 324
file save 320
file types 328
files - manage without a mouse 336
firmware and help upgrade 958
firmware rev number 30
fixed marker type 272
fixture simulator 200
flatness and gain, small signal 1064
flush thru cal 235
formats - data 72
 group delay 73
 imaginary 74
 linear mag 73
 log mag 73
 phase 73
 polar 74
 real 74
 rectangular 72
 smith chart 74
 SWR 73
frequency blanking 22, 1019

frequency drift 111
frequency range 42
frequency resolution 44
frequency, CW 43
front panel 1076
front panel keypad not working 892
front panel specification 1076
functions, marker 291
G
gage connectors 1040
gain and flatness, small signal 1064
gain definition 1048
gain drift versus time 1048
gain drift versus time, definition 1048
gain flatness 1048
gain flatness, definition 1048
gating 118
 reflection response 118
 transmission response 118
general specifications 1076
getting data with scpi 863
global - trigger 62
global pass-fail indicator 314
GPIB - configure 860
GPIB Address 852
GPIB Commands 345
GPIB Fundamentals 852
GPIB Interface 956
GPIB Local - Remote Label 862
grid lines solid/dotted 84
grounding test cables 1045
group delay format 73
group delay measurement 1066
group trigger 62
guided calibration 132
guided power cal 141
H
handshake - trigger 69
hard disk - version 30

hard disk recovery 3

hard disk, save file to 320

harmonics specification 1076

heel strap - ESD 1045

help - about 30

help -using 28

hold - max & min 311

hold mode 62

I

IF bandwidth 114

IF bandwidth - for segment sweep 52

IF bandwidth - how to set 114

image - saving screen 341

imbalance parameters 1052

impedance 36

 setting system 1028

independent segments 52

input 1076

input receiver - specifications 1076

inspect connectors 1041

Installation and Quick Start Guide 28

instrument calibration 960

instrument noise 221

instrument specifications 1076

instrument state 326

interface control 881, 1022, 1029

interpolation ON/off 160

interpolation, effects on error correction 162

inverse Smith chart 75

IO libraries 879

isolation error 223

2-port calibration 232

isolation, 2-port calibration 232

J

jpeg format 341

K

keypad not working 892

L

LAN Connections 4

LCD display test 974

leakage, crosstalk 117

level 45

leveling-ALC 47

limit lines 312

limit table 84

linear frequency sweep 51

linear phase shift, compensate for 103

LO source - configure for mixers 986, 990

load match error 224

load types 261

local 862

log errors 948, 1013

log on 1

log sweep 49

logical receiver notation 38

long devices electrically 106

loss 36

low-loss 2-port devices 108

LRL line auto characterization 269

LVL 48

LXI 26, 886

M

macros 125, 888

magnitude offset 80

manage files without a mouse 320

manual 62

marker functions 291

marker search 273

 bandwidth 273

 domain 290

 execute 274

 peak 278

 target 273

 types 273

markers 272

 coupled 273

delta 272

discrete 272

- display 292
- fixed** 272
- formats** 272
- move 272
- normal 272
- readout 292
- reference** 272
- table 294
- material handler interface control 881, 1022, 1029
- math 296
- math operations, data-memory 296
 - statistics 298
- mating plane surfaces 1039
- max - min hold 311
- measurement annotation 81
- measurement calibration 219
- measurement calibration method 129
 - accurate 231
 - improve crosstalk 117
 - select type 129
 - validity of 238
- measurement classes 34
- measurement errors 221
- measurement parameters 36
 - arbitrary ratio 37
 - balanced** 40
 - S-parameters 36
 - unratioed power 37
- measurement reference plane 231
- measurement stability, increase 111
- measurement throughput 1076
- measurement throughput - specifications 1076
- measurement throughput techniques 121
- measurement, averages 113
- measurements, phase 1072
- memory 296
- memory trace 296
- messages - error 947, 1012
- minimize application 95
- mixed mode S-parameters 1050
- model 71
- model for data-based calibration 232
- model for polynomial calibration 232
 - data-based 232
 - polynomial 232
- modify 246
- modify calibration kits 246
- mouse - mange files without 336
- move marker 272
- multiple measurements for throughput 121
- multiple power sensors 141
- multiport testset - E5092A 1006
- N**
- Network Analyzer - about 30
- network analyzer specifications 1076
- network analyzer users 1
- new windows 13
- noise - reduce 113
- noise floor 117
- noise reduction 113
- noise specification 1076
- non-insertable device calibrations 234
- normal 272
- normal marker type 272
- normalize 297
- O**
- offset - magnitude 80
- offset - phase 104
- offset load** 262
- on and off 6
- open-loop leveling** 47
- operating system errors 947, 1012
- operating system recovery 3
- operator's check 975
- option enable 959
- output 1076
- output power, absolute 1046

overlapping sweep segments 57

P

parameters, amplifier 1048

parameters, measurement 36

pass-fail indicator 314

password 1

pc - connect to 24

peak 278

peak, marker 278

phase measurement accuracy 103

phase measurements 1072

phase offset 104

phase shift 104

phase, linear 1061

phase-shift component 1066

pixel test 974

PMAR 998

PNOP markers 286

point 62

point limit test 318

point spacing - x axis 56

point sweep 59

point-averaging 113

polar format 74

polynomial model for calibration 232

port extensions 211

power calibration 188

power compensation - fixture 208

power level 45

power meter as receiver 998

power On and Off 6

power sensor as receiver 998

power unlevelled 48

power, line specifications 1076

power-up conditions 32

preferences - error 947, 1012

preset conditions 32

preset user defined 32

primary GPIB address 852

print options 340

print to file 341

printers 338

probe specifications 1076

product support 973

programming guide 343, 885

protection - antivirus 4

protection - ESD 1045

PSAT markers 286

Q

queues 863

Quick Start dialog 15

Quick Start Guide 28

R

random measurement errors 221

range, dynamic 101

range, power 45

ratio, arbitrary 37

rear panel 1076

rear panel interface control 881, 1022, 1029

rear panel specifications 1076

recall and sweep speeds - specifications 1076

recall measurements quickly 122

receiver crosstalk 117

receiver dynamic range 1076

receiver input - specifications 1076

receiver power cal 197

receivers- measurement 37

recovering the operating system 3

redo 99

reduce trace noise 113

reference impedance for a fixture 200

reference level 78

reference level & stability 1076

reference level & stability - specs 1076

reference marker 272

reference plane 231

reference position 78

reference receivers 37

1-port calibration 130
reflection accuracy 108
reflection classes, calibration standards 246
reflection tracking error 225
relative velocity 103
remote-GPIB 862
response calibration 129
restart - trigger 62
restore ECAL data 181
restore the operating system 3
return loss 1049
reverse isolation 1048
reverse sweep 57
revision number 30
rolloff, coupler 118
S
s1p - s2p -s3p files 335
save and recall a file 320
save as 320
save calibration 139
saving data 335
saving screen capture 341
scale 77
scope 62
scope, trigger 62
SCPI Commands 345
SCPI Errors 963
SCPI Fundamentals 852
SCPI Syntax 856
screen capture 341
screen test 974
search, marker 273
securing the VNA 22, 1019
security frequency blanking 22, 1019
segment 84
segment point spacing 56
segment sweep 52
segment table 84
segments, limit 314
serial number - instrument 30
service request 874
setup macros 125, 888
SICL 879
signal purity specification 1076
simulator - fixture 200
single 62
single and double click option. 4
single-ended devices 1050
sliding load 261
slope 46
slope, power 46
small signal gain and flatness 1064
SmartCal 132
smith chart 74
smoothing - trace 115
sockets 860
software version 30
SOLT calibration 129
source 62
source match error 223
source power cal 188
source unlevelled 48
source, trigger 62
spacing between frequency points 104
S-parameters 36
specifications 1076
speed, data transfer 124
speed, sweep 119
spreadsheet - saving data to 328
spurious specification 1076
SRQ 874
stability, measurement 111
standard definition 243
standards, calibration 246
start VNA application 32
state - instrument 326
state, trigger 62
static electricity 1045

statistics 298
status bar 87
status registers 874
stepped sweep 59
stimulus sweep 49
support 973
swap equal adapter cal 217
sweep 52
sweep averages 113
sweep in reverse 57
sweep indicator 58
sweep setup 58
sweep speed 119
sweep time 58
sweep types 49
switch repeatability 221
SWR 36
synchronizing commands 867
system bandwidths 1076
system bandwidths - specifications 1076
system impedance 1028
system performance, corrected 1076
system performance, uncorrected 1076
system restoration 3
system verification 976
systematic measurement errors 221
T
table mat - ESD 1045
tables 84
technical support 973
telnet 860
temperature drift 111
terminate reflection measurement 108
test port input (receiver) 1076
test port output (source) 1076
test port specifications 1076
test set (configurable) block diagram 1076
test set block diagram 1076
test set interface control 881, 1022, 1029

testset control -E5092A 1006
theme - windows 4
threshold 278
throughput, increased 121
thru - unknown 236
thru response calibration 131
timeout 867
title - trace 94
title - window 94
title bars 87
TMSA 1050
toolbars 85
topology - balanced 1053
torque wrench 1043
touchstone format 335
trace 8
trace noise 1076
trace smoothing 115
trace status 82
trace triggering 62
traces - channels and windows 8
transfer speed, data 124
transmission 36
transmission classes, calibration standards 246
transmission tracking error 226
trigger 61
TRL calibration 185
troubleshoot the analyzer 892
types, marker 272
typical cycle time 1076
U
uncorrected system performance 1076
uncorrected system performance - specs 1076
under-sampled data 111
undo 99
unknown thru cal 236
unleveled 48
unratioed 37
unratioed power 37

unwrapped phase display 73
upgrade VNA firmware 958
USB device - the VNA 873
USB port specifications 1076
USB Power Sensor as Receiver 998
USB Power Sensors 189
USB/GPIB Interface 956
user logon 1
user name 1
user preset 32
user range 298
user span 290
user-characterization 170
V
velocity factor 103
verification - system 976
verifying calibration 238
version - firmware 30
view/modify standards 266
VISA 879
VNA specifications 1076

VNA start 32
VNC 25
W
warm-up spec 1076
waveguide 258
web server 26, 886
window - calibration 132
window - customize 81
windows - creating and managing 13
Windows OS 4
windows theme 4
windows traces and channels 8
wizard, calibration 132
X
X-axis point spacing -segment sweep 56
Y
Y-axis Scale 77
Z
Z conversion - balanced 206
Z0 System Impedance 1028